

# nopa<sup>®</sup> instruments

---

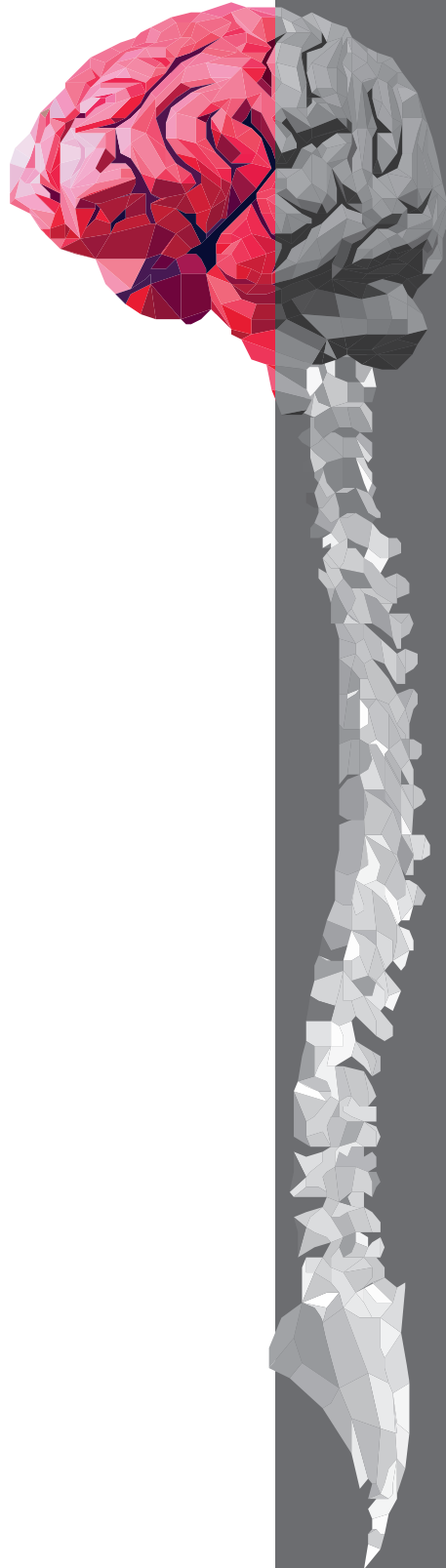

neurochirurgie  
neurosurgery  
neurocirugía  
neurochirurgie  
neurochirurgia



Dies ist unser Neurochirurgie-Katalog, er bleibt unser ausschließliches Eigentum.  
Es gelten unsere allgemeinen Lieferbedingungen.  
Sie finden diese auf unserer Internetseite:  
[www.nopa.de](http://www.nopa.de)

This is our neurosurgery catalogue. It remains our exclusive property.  
Please find our "General Terms of Sale" on our corporate website:  
[www.nopa.de](http://www.nopa.de)

Este es nuestro catálogo neurocirugía. El catálogo queda nuestra propiedad.  
Nuestras condiciones generales de venta se encuentran en nuestra página web:  
[www.nopa.de](http://www.nopa.de)

Voilà notre catalogue neurochirurgie. Il demeure notre propriété.  
Veuillez consulter nos conditions générales de vente sur notre page Internet:  
[www.nopa.de](http://www.nopa.de)

Ecco il nostro catalogo di neurochirurgia. Il catalogo rimane nostra proprietà.  
Trovate le nostre condizioni generali di fornitura sul nostro sito:  
[www.nopa.de](http://www.nopa.de)



**Wir weisen ausdrücklich darauf hin, dass die gezeigten/genannten Produkte nur von ausgebildetem Fachpersonal mit entsprechender Qualifikation und unter der Voraussetzung des sachgemäßen, zweckbestimmten und bestimmungsgemäßen Gebrauchs, laut Angaben der Bedienungsanleitung verwendet und eingesetzt werden dürfen. Unsachgemäße und die nicht bestimmungsmäßige Verwendung der Produkte kann zu schwerwiegenden und unerwünschten Folgen sowie Komplikationen führen.**

**We expressly point out that the products shown/mentioned may only be used and operated by trained specialist personnel with the appropriate qualifications, and for the proper, intended and prescribed purpose as specified in the operating instructions. Improper and/or non-prescribed use of the products may lead to serious and undesirable consequences as well as complications.**

**Señalamos expresamente que los productos mostrados/nombrados sólo pueden ser utilizados y aplicados por personal especializado capacitado y con las debidas calificaciones y bajo la condición de que se haga un uso adecuado, previsto y apropiado, de acuerdo con la información de las instrucciones de funcionamiento. El uso indebido de los productos y su utilización no conforme pueden tener consecuencias y complicaciones graves e indeseables.**

Modelländerungen vorbehalten. Nachdruck, auch auszugsweise, verboten.  
Change of design and pattern reserved. Re-printing, even in extracts, not permitted.  
Nos reservamos el derecho de modificaciones sin aviso previo. Reimpresión, también parcialmente, está prohibido.  
Tous droits réservés aux changements de modèle. Réimprimer, également partiellement, est interdit.  
Noi riserviamo il diritto di effettuare delle modificazioni. Ristampa di divieto anche parziale.

Bitte fordern Sie unsere  
entsprechenden Kataloge an.

Please request our  
appropriate catalogues.

Por favor pida nuestros  
catálogos apropiados.

Veuillez demander nos  
catalogues appropriés.

Vi preghiamo di richiedere  
i nostri cataloghi appropriati.

**>> Unser Lieferprogramm**

Allgemeine Chirurgie  
Gynäkologie und Urologie  
Hysteroskopie  
Zystoskopie  
HNO / plastische Chirurgie  
Thorax, Herz und Gefäßchirurgie  
Neurochirurgie  
Ophthalmologie  
Endoskopie  
Arthroskopie  
Container und Sterilisation  
Dental und Oral  
Podologie

**>> Our product range**

General Surgery  
Gynecology and Urology  
Hysteroscopy  
Cystoscopy  
ENT / plastic surgery  
Thoracic and cardiovascular surgery  
Neurosurgery  
Ophthalmology  
Endoscopy  
Arthroscopy  
Container and sterilization  
Dental and Oral  
Podology

**>> Nuestra gama  
de productos**

Cirugía general  
Ginecología y Urología  
Histeroscopia  
Cistoscopia  
ORL / cirugía plástica  
Cirugía torácica y cardiovascular  
Neurocirugía  
Oftalmología  
Endoscopia  
Artroscopia  
Contenedor y esterilización  
Odontología y Oral  
Podología

**>> Notre gamme  
des produits**

Chirurgie générale  
Gynécologie et Urologie  
Hystérocopie  
Cystoscopie  
ORL / chirurgie plastique  
Chirurgie thoracique et cardiovasculaire  
Neurochirurgie  
Ophtalmologie  
Endoscopie  
Arthroscopie  
Conteneur et stérilisation  
Dental et Oral  
Podologie

**>> La nostra gamma  
di prodotti**

Chirurgia generale  
Ginecologia e Urologia  
Isteroscopia  
Cistoscopia  
ORL / chirurgia plastica  
Chirurgia toracica e cardiovascolare  
Neurochirurgia  
Oftalmologia  
Endoscopia  
Artroscopia  
Contentitore e sterilizzazione  
Odontoiatria e Orale  
Podologia

nopa<sup>®</sup>













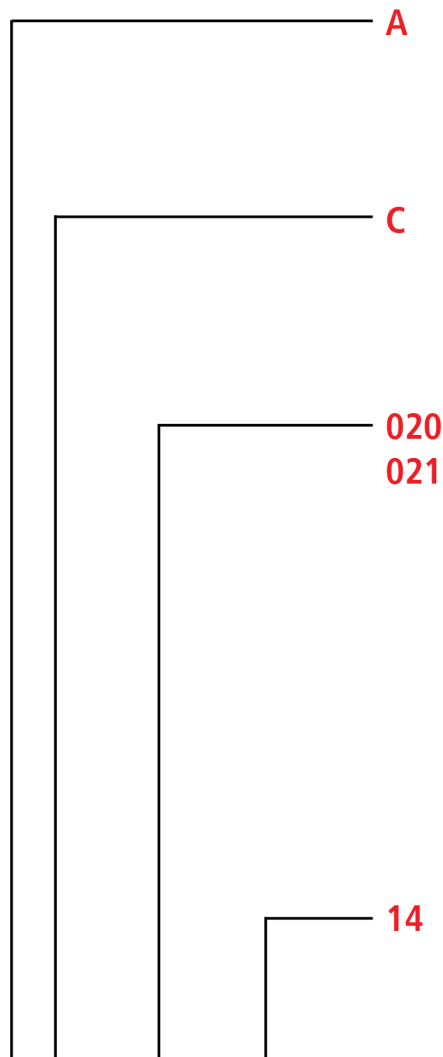

Artikelcode **AC 020/14**

#### Allgemeines Instrumentarium

General Instruments  
Instrumental Général  
Instruments Générales  
Strumenti generali

#### Scheren

Scissors  
Tijeras  
Ciseaux  
Forbici

#### Fortlaufende Nummern

Gerade Ziffer = gerades Instrument  
Ungerade Ziffer = gebogenes Instrument

#### Continuous number

Even number = straight instrument  
Odd number = curved instrument

#### Número de orden

números pares = instrumento derecho  
números impares = instrumento curvado

#### Numéros d'ordre

numéro pair = instrument droit  
numéro impair = instrument courbe

#### Numeri progressivamente

numero pari = strumento retto  
numero dispari = strumento curvo

#### Länge oder Figur

Length or Figure  
Longitud o figura  
Longueur ou figure  
Lunghezza o figura



## INDEX

>> Klemmen >> Hemostats >> Pinzas hemostáticas >> Pincas hémostatiques >> Pinze emostatiche	7–10	AA
>> Pinzetten >> Forceps >> Pinzas >> Pincas >> Pinze	11–20	AB
>> Scheren >> Scissors >> Tijeras >> Ciseaux >> Forbici	21–34	AC
>> Naht >> Suture >> Sutura >> Suture >> Sutura	35–42	AE
>> Wundhaken >> Retractors >> Separadores >> Ecarteurs >> Divaricatori	43–54	AK
>> Punktion/Kanülen >> Puncture/Special Needles >> Punción/Agujas especiales >> Punction/Aiguilles spéciales >> Puntura/Aghi speciali	55–56	AO
>> Diagnostik >> Diagnostics >> Diagnóstico >> Diagnostic >> Diagnostica	57–60	AR
>> Orthopädie >> Orhtopaedics >> Ortopedia >> Orthopédie >> Ortopedia	61–82	KA
>> Neurochirurgie >> Neurosurgery >> Neurocirugía >> Neurochirurgie >> Neurochirurgia	83–168	KS
>> Endoskopie >> Endoscopy >> Endoscopia >> Endoscopie >> Endoscopia	169–172	XR
>> Endoskopie >> Endoscopy >> Endoscopia >> Endoscopie >> Endoscopia	173–178	XT



KLEMMEN  
HEMOSTATS  
PINZAS HEMOSTATICAS  
PINCES HEMOSTATIQUES  
PINZE EMOSTATICHE

AA

nopa<sup>®</sup> instruments



Kopfhautklemmen  
 Scalp Flap Forceps  
 Pinzas hemostáticas para pericráneo  
 Pincés hémostatiques pour le cuir chevelu  
 Pinze emostatiche per il cuoio capelluto

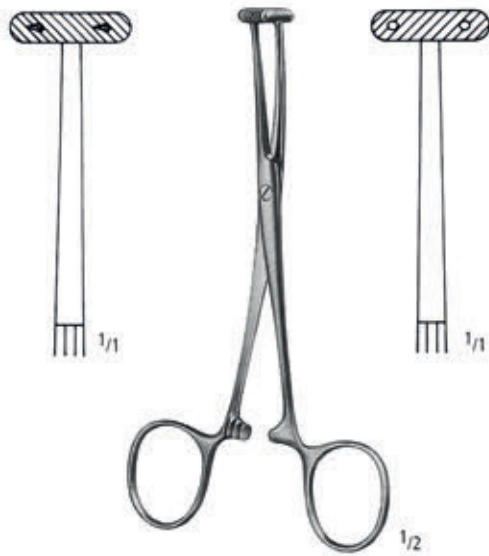

**MARTEL**  
**AA 078/14**  
 14,0 cm/5 1/2"

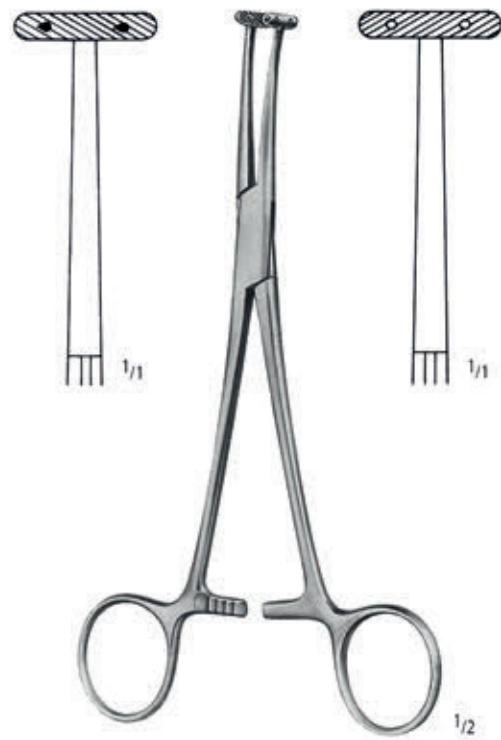

**WILLET-MARTEL**  
**AA 078/19**  
 19,0 cm/7 1/2"



Feine Arterienklemmen  
 Fine Artery Forceps  
 Pinzas hemostáticas finas  
 Pincas hémostatiques fines  
 Pinze emostatiche fine

AA

AB

AC

AE

AK

AO

AR

KA

KS

XR

XT

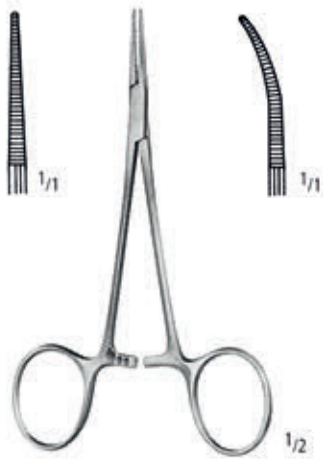

**MICRO-MOSQUITO**

AA 130/10      AA 131/10  
 AA 130/12      AA 131/12

10,0 cm/4"  
 12,0 cm/4<sup>3</sup>/<sub>4</sub>"

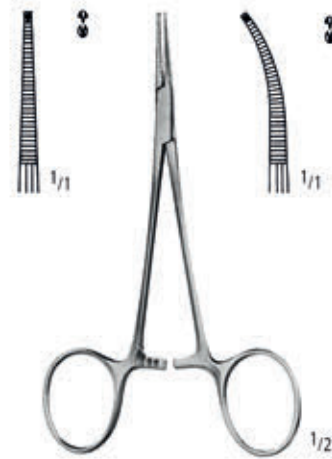

**MICRO-MOSQUITO 1:2**

AA 132/10      AA 133/10  
 AA 132/12      AA 133/12



**BABY-OVERHOLT**

AA 225/13  
 13,5 cm/5<sup>1</sup>/<sub>4</sub>"



**BABY-ADSON**

AA 235/14  
 14,0 cm/5<sup>1</sup>/<sub>2</sub>"

Präparierklemmen  
Dissecting Forceps  
Pinzas para preparaciones  
Pincès à dissection  
Pinze per preparazione



**DANDY**  
**AA 291/14**  
14,0 cm/5 1/2"

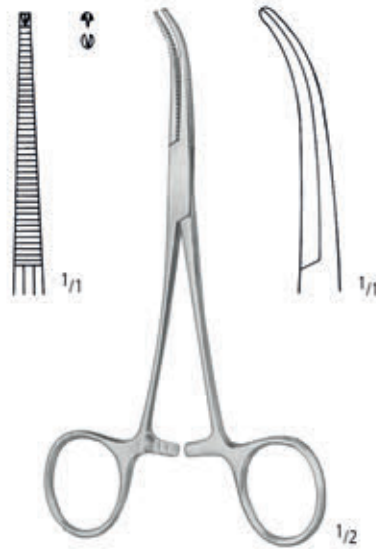

**DANDY 1:2**  
**AA 293/14**  
14,0 cm/5 1/2"



**AA 349/01 AA 349/02**

**BABY-MIXTER**  
14,0 cm/5 1/2"



**GEMINI**



**AA 365/14**  
14,0 cm/5 1/2"



**AA 365/18**  
18,0 cm/7"



**AA 365/22**  
22,0 cm/8 3/4"



**AA 365/25**  
25,0 cm/10"



**AA 365/28**  
28,0 cm/11"

Weitere Klemmen siehe Katalog A 7-51 und Gruppe KS.  
For further hemostats see catalogue A 7-51 and section KS.  
Para otras pinzas hemostáticas ver catálogo A 7-51 y sección KS.  
D'autres pincès hémostatiques voir notre catalogue A 7-51 et groupe KS.  
Per altre pinze emostatiche consultare il nostro catalogo A 7-51 e gruppo KS.

PINZETTEN  
FORCEPS  
PINZAS  
PINCES  
PINZE

AB

nopa<sup>®</sup> instruments



**AB** PINZETTEN FORCEPS PINZAS PINCES PINZE

Anatomische Pinzetten, Chirurgische Pinzetten  
 Dressing Forceps, Tissue Forceps  
 Pinzas de disección, Pinzas de disección con dientes  
 Pincers à dissection, Pincers à griffes  
 Pinze anatomiche per dissezione, Pinze chirurgiche a denti di topo



**AB 100/12**

1/2



**AB 102/12**

1/2



**AB 110/12**

1/2



**AB 112/12**

1/2

12,0 cm/4<sup>3</sup>/<sub>4</sub>"  
 15,0 cm/6"

**ADSON**  
**AB 100/12**  
**AB 100/15**

**MICRO-ADSON**  
**AB 102/12**  
**AB 102/15**

**ADSON 1:2**  
**AB 110/12**  
**AB 110/15**

**MICRO-ADSON 1:2**  
**AB 112/12**  
**AB 112/15**



**7 : 7**  
**AB 116/07**

**9 : 9**  
**AB 116/09**

1/2



**9 : 9**

1/2

**ADSON-BROWN**

12,0 cm/4<sup>3</sup>/<sub>4</sub>"

**ADSON-BROWN**

**AB 117/09**  
 12,0 cm/4<sup>3</sup>/<sub>4</sub>"



PINZETTEN FORCEPS PINZAS PINCES PINZE

Anatomische Pinzetten, Chirurgische Pinzetten  
 Dressing Forceps, Tissue Forceps  
 Pinzas de disección, Pinzas de disección con dientes  
 Pincés à dissection, Pincés à griffes  
 Pinze anatomiche per dissezione, Pinze chirurgiche a denti di topo

AA

AB

AC

AE

AK

AO

AR

KA

KS

XR

XT



**CUSHING**  
**AB 180/17**

17,5 cm/7"



**CUSHING**  
**AB 181/17**



**CUSHING 1:2**  
**AB 190/17**

17,5 cm/7"



**CUSHING 1:2**  
**AB 191/17**

**AB** PINZETTEN FORCEPS PINZAS PINCES PINZE

Uhrmacherpinzetten  
 Jeweler's Forceps  
 Pinzas de relojero  
 Pincès d'horloger  
 Pinze da orologiaio



No. 1 **AB 501/01**  
 12,0 cm/4<sup>3</sup>/<sub>4</sub>"



No. 2 **AB 501/02**  
 12,0 cm/4<sup>3</sup>/<sub>4</sub>"



No. 3 **AB 501/03**  
 12,0 cm/4<sup>3</sup>/<sub>4</sub>"



No. 4 **AB 501/04**  
 11,0 cm/4<sup>1</sup>/<sub>2</sub>"



No. 5 **AB 501/05**  
 11,0 cm/4<sup>1</sup>/<sub>2</sub>"



No. 5a **AB 501/15**  
 11,0 cm/4<sup>1</sup>/<sub>2</sub>"



No. 5/45° **AB 501/45**  
 10,5 cm/4"



No. 5/90° **AB 501/90**  
 10,5 cm/4"



No. 7 **AB 502/07**  
 11,5 cm/4<sup>1</sup>/<sub>2</sub>"

PINZETTEN FORCEPS PINZAS PINCES PINZE

Fasspinzetten  
Grasping Forceps  
Pinzas para coger  
Pincers pour saisir les tissus  
Pinze per afferrare tessuti



**AB 506/01** Ø 3,0 mm  
**AB 506/02** Ø 3,0 mm

**SAMII**  
24,0 cm/9<sup>1</sup>/<sub>4</sub>"



**AB 507/01** Ø 3,0 mm  
**AB 507/02** Ø 5,0 mm

Löffel  
spoon  
cucharilla  
cuiller  
cucchiaio

**AB 508/01** Ø 3,0 mm  
**AB 508/02** Ø 5,0 mm

flach  
flat  
plano  
plat  
piatto

22,0 cm/8<sup>3</sup>/<sub>4</sub>"



**AB 509/01** Ø 3,0 mm  
**AB 509/02** Ø 5,0 mm

Kürette  
curette  
cureta  
curette  
curetta

**HEIFETZ**  
22,0 cm/8<sup>3</sup>/<sub>4</sub>"



**HUNT**  
**AB 510/20**  
20,0 cm/8"



16,0 cm/6<sup>1</sup>/<sub>4</sub>"

18,0 cm/7"  
20,0 cm/8"  
22,0 cm/8<sup>3</sup>/<sub>4</sub>"  
24,0 cm/9<sup>1</sup>/<sub>2</sub>"

0,6 mm

0,9 mm

1:2

**AB 515/16** **AB 516/16**

**AB 515/18** **AB 516/18** **AB 517/18**

**AB 515/20** **AB 516/20**

**AB 515/22** **AB 516/22**

**AB 515/24** **AB 516/24**

AA  
AB  
AC  
AE  
AK  
AO  
AR  
KA  
KS  
XR  
XT

**AB** PINZETTEN FORCEPS PINZAS PINCES PINZE

Mikro-Pinzetten, Knüpfpinzetten mit Plateau  
 Micro Forceps, Suture Tying Forceps with platform  
 Micro-Pinzas, Pinzas de ligadura con plataforma  
 Micro-Pinces, Pinces à ligature avec plate-forme  
 Micro-Pinze, Pinze per ligature con piattaforma

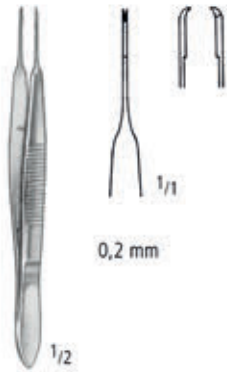

**AB 530/09 1:2**  
 9,5 cm/3<sup>3</sup>/<sub>4</sub>"

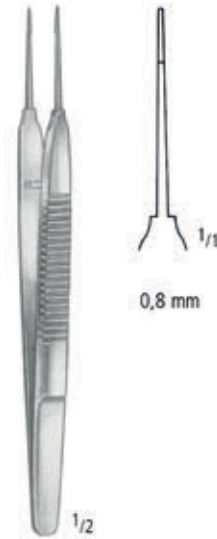

**AUSTIN**  
**AB 532/14**  
 14,0 cm/5<sup>1</sup>/<sub>2</sub>"



**AUSTIN**  
**AB 532/18**  
 18,0 cm/7"



**AB 534/12**  
 12,0 cm/4<sup>3</sup>/<sub>4</sub>"



**WISE**  
**AB 534/13**  
 13,5 cm/5<sup>1</sup>/<sub>4</sub>"



**WISE**  
**AB 535/13**  
 13,5 cm/5<sup>1</sup>/<sub>4</sub>"



PINZETTEN FORCEPS PINZAS PINCES PINZE

Mikro-Pinzetten, Knüpfpinzetten mit Plateau  
 Micro Forceps, Suture Tying Forceps with platform  
 Micro-Pinzas, Pinzas de ligadura con plataforma  
 Micro-Pinces, Pinces à ligature avec plate-forme  
 Micro-Pinze, Pinze per ligature con piattaforma

AA

AB

AC

AE

AK

AO

AR

KA

KS

XR

XT



**AB 536/14**  
 14,0 cm/5 1/2"



**AB 538/14** 1:2  
 14,0 cm/5 1/2"



**AB 540/14** 1:2  
 14,0 cm/5 1/2"

**AB** PINZETTEN FORCEPS PINZAS PINCES PINZE

Mikro-Pinzetten  
 Micro Forceps  
 Micro-Pinzas  
 Micro-Pinces  
 Micro-Pinze



12,0 cm/4<sup>3</sup>/<sub>4</sub>"  
 15,0 cm/6"



0,3 mm

**AB 542/12**  
**AB 542/15**



0,3 mm

**AB 543/12**  
**AB 543/15**



18,0 cm/7"



**AB 544/18**



**AB 545/18**

Weitere Mikro-Pinzetten siehe Gruppe KS.  
 For further micro forceps see section KS.  
 Para otras micro-pinzas ver sección KS.  
 D'autres micro-pinces voir groupe KS.  
 Altre micro-pinze vedi gruppo KS.

PINZETTEN FORCEPS PINZAS PINCES PINZE

Atraumatische Pinzetten  
 Non-traumatic Vascular Tissue Forceps  
 Pinzas Atrauma  
 Pincas Atrauma  
 Pinze Atrauma

AA

AB

AC

AE

AK

AO

AR

KA

KS

XR

XT



1,5 mm

- AB 860/16 = 16,0 cm/6<sup>1</sup>/<sub>4</sub>"
- AB 860/20 = 20,0 cm/8"
- AB 860/24 = 24,0 cm/9<sup>1</sup>/<sub>4</sub>"

1/2

DE BAKEY

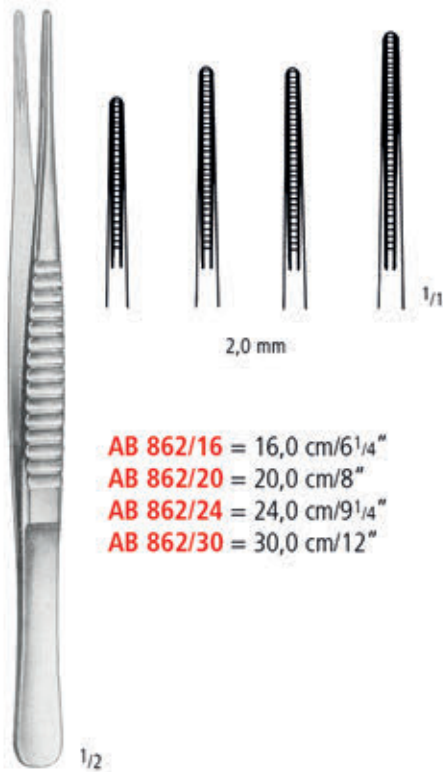

2,0 mm

- AB 862/16 = 16,0 cm/6<sup>1</sup>/<sub>4</sub>"
- AB 862/20 = 20,0 cm/8"
- AB 862/24 = 24,0 cm/9<sup>1</sup>/<sub>4</sub>"
- AB 862/30 = 30,0 cm/12"

1/2

DE BAKEY

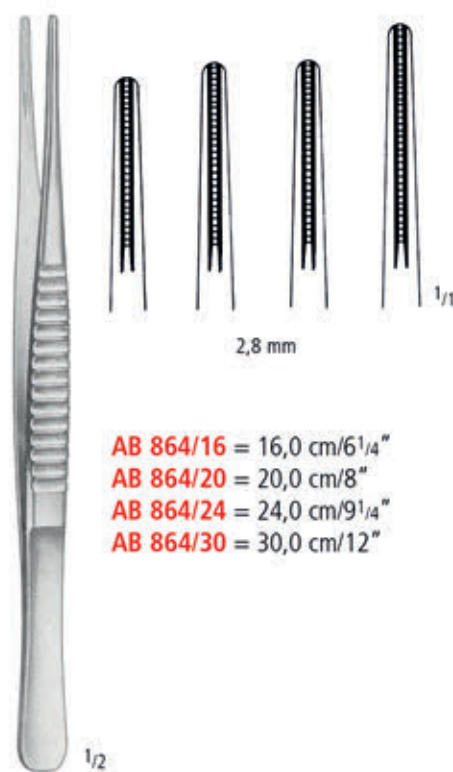

2,8 mm

- AB 864/16 = 16,0 cm/6<sup>1</sup>/<sub>4</sub>"
- AB 864/20 = 20,0 cm/8"
- AB 864/24 = 24,0 cm/9<sup>1</sup>/<sub>4</sub>"
- AB 864/30 = 30,0 cm/12"

1/2

DE BAKEY

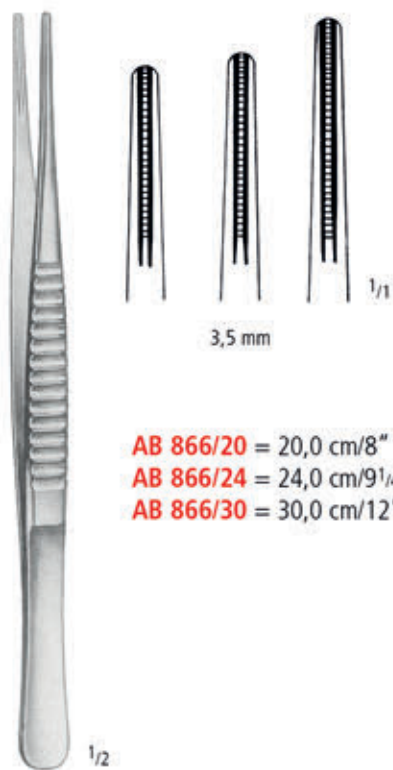

3,5 mm

- AB 866/20 = 20,0 cm/8"
- AB 866/24 = 24,0 cm/9<sup>1</sup>/<sub>4</sub>"
- AB 866/30 = 30,0 cm/12"

1/2

DE BAKEY

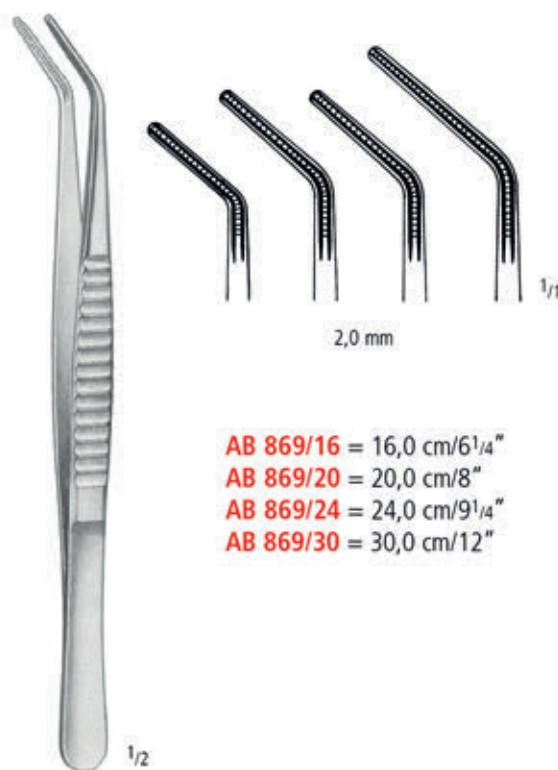

2,0 mm

- AB 869/16 = 16,0 cm/6<sup>1</sup>/<sub>4</sub>"
- AB 869/20 = 20,0 cm/8"
- AB 869/24 = 24,0 cm/9<sup>1</sup>/<sub>4</sub>"
- AB 869/30 = 30,0 cm/12"

1/2

DE BAKEY

**AB** PINZETTEN FORCEPS PINZAS PINCES PINZE

Pinzetten mit Hartmetalleinsätzen  
 Dissecting Forceps with Tungsten Carbide Inserts  
 Pinzas de disección con bocas de carburo de tungsteno  
 Pincès à dissection avec mors en carbure de tungstène  
 Pinze per dissezione con punte di carburo di tungsteno



**ADSON**



**CUSHING**  
17,5 cm/7"



mit Dissektor-Ende  
 with dissector end  
 con cabo disecador  
 avec bout dissecteur  
 con dissettore



**CUSHING-TAYLOR**  
**AB 943/18**  
18,0 cm/7"

SCHEREN  
SCISSORS  
TIJERAS  
CISEAUX  
FORBICI

AC

nopa<sup>®</sup> instruments



**AC** SCHEREN SCISSORS TIJERAS CISEAUX FORBICI

Scheren für Neurochirurgie  
 Scissors for Neuro Surgery  
 Tijeras para neurocirugía  
 Ciseaux pour neurochirurgie  
 Forbici per neurochirurgia



**AC 168/15**

**AC 169/15**



15,0 cm/6"

Nerv-Präparierschere  
 Nerve dissecting scissors  
 Tijeras para nervios  
 Ciseaux pour nerfs  
 Forbici per nervi



geknöpft  
 probe pointed  
 con botón  
 boutoné  
 bottenuto

**AC 231/22**  
 22,0 cm/8<sup>3</sup>/<sub>4</sub>"

**STRULLY**



**AC 232/22**  
 22,0 cm/8<sup>3</sup>/<sub>4</sub>"



**DANDY**  
**AC 233/17**  
 17,0 cm/6<sup>3</sup>/<sub>4</sub>"



**SCHMIEDEN-TAYLOR**

14,5 cm/5<sup>1</sup>/<sub>2</sub>"      **AC 241/15**  
 17,0 cm/6<sup>3</sup>/<sub>4</sub>"      **AC 241/17**



**OLIVECRONA**

**AC 259/23**  
 23,0 cm/9"



SCHEREN SCISSORS TIJERAS CISEAUX FORBICI

Mikroscheren  
Micro Scissors  
Micro Tijeras  
Micro Ciseaux  
Micro Forbici

- >> Alle unsere Mikroscheren werden von Fachkräften mit jahrelanger Erfahrung hergestellt. Die Endkontrolle findet unter dem Mikroskop statt. Um Ihnen ein ermüdungsfreies Arbeiten zu ermöglichen, wird dem Federdruck größte Aufmerksamkeit gewidmet.
- >> Bitte wählen Sie unter Rund- oder Flachgriffscheren.

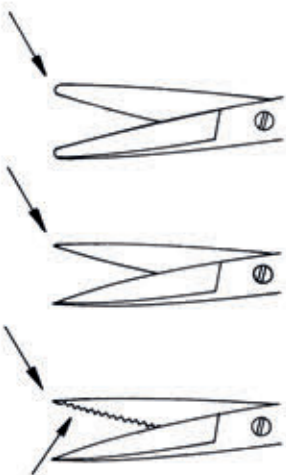

**Dissection:** **Gebogene Blätter, abgerundete Spitzen** ermöglichen eine gute und sichere Dissektion, ohne Nerven und Blutgefäße zu beschädigen.

**Adventitia:** **Gerade Blätter, sehr scharfe Spitzen** gewährleisten präzises Anfrischen von Gefäßenden.

**Nerve:** Ein Blatt ist **fein gezahnt**, um ein Herausgleiten des Nervs zu vermeiden.

- >> All our Micro Scissors are manufactured by skilled craftsmen with many years of experience. Final inspection is carried out under a microscope. Careful attention is paid to the closing pressure of the spring handle, to ensure precise work during surgeries, without fatigue.
- >> Round or flat handle scissors according to your preference.

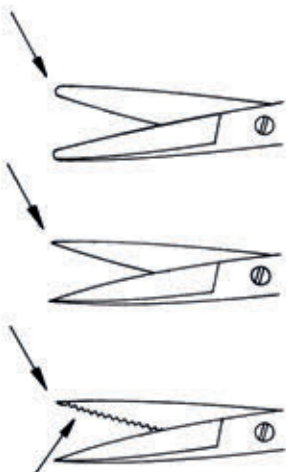

**Dissection:** **Curved blades, slightly rounded tips** ensure safe dissection without damage to nerves and vessels.

**Adventitia:** **Straight blades, very sharp tips** for finest trimming of vessel ends.

**Nerve:** One blade is **fine-toothed** to avoid slipping of the nerve.

AA  
AB  
AC  
AE  
AK  
AO  
AR  
KA  
KS  
XR  
XT

Mikroscheren  
Micro Scissors  
Micro Tijeras  
Micro Ciseaux  
Micro Forbici



14,5 cm/5 1/2"



**Dissection**  
**AC 801/15**

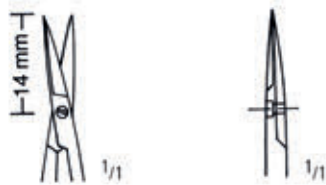

**Adventitia**  
**AC 803/15**



18,0 cm/7"



**Dissection**  
**AC 801/18**

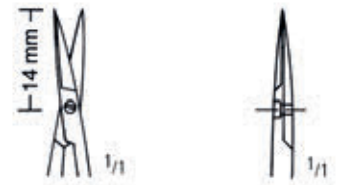

**Adventitia**  
**AC 803/18**

SCHEREN SCISSORS TIJERAS CISEAUX FORBICI

Mikroscheren  
Mikro Scissors  
Micro Tijeras  
Micro Ciseaux  
Micro Forbici

AA

AB

AC

AE

AK

AO

AR

KA

KS

XR

XT

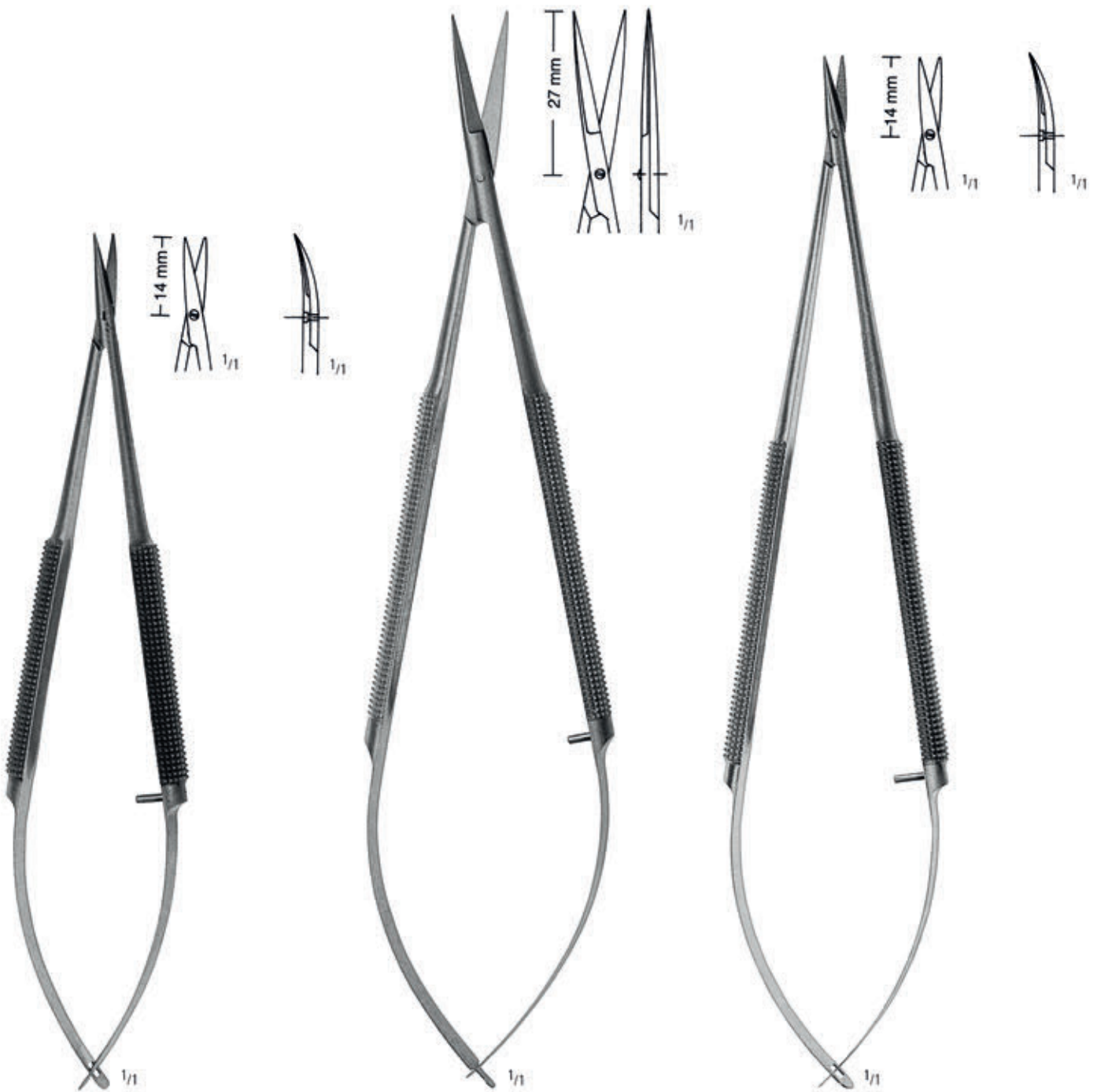

**AC 807/14**  
14,5 cm/5½"

**AC 812/18**  
18,0 cm/7"

**AC 817/18**  
18,0 cm/7"

**AC** SCHEREN SCISSORS TIJERAS CISEAUX FORBICI

Mikroscheren  
Micro Scissors  
Micro Tijeras  
Micro Ciseaux  
Micro Forbici



11,0 cm/4 1/2"

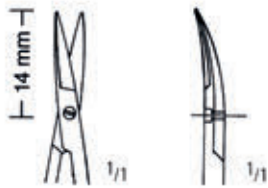

**Dissection**  
**AC 821/11**

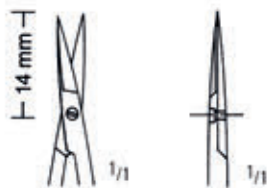

**Adventitia**  
**AC 830/11**



15,0 cm/6"

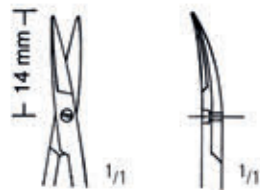

**Dissection**  
**AC 823/15**

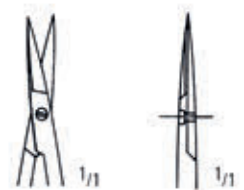

**Adventitia**  
**AC 832/15**

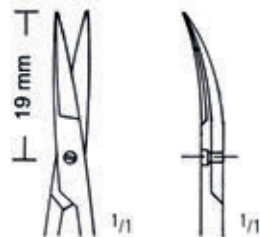

**Dissection**  
**AC 825/15**

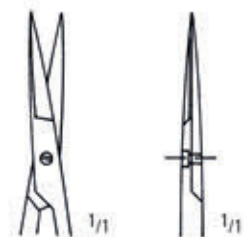

**Adventitia**  
**AC 834/15**

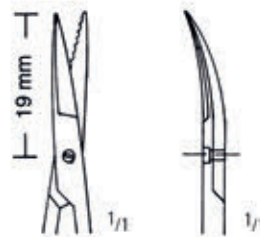

**Dissection**  
**AC 827/15**

**>> Nerve >> Adventitia**  
**AC 836/15**

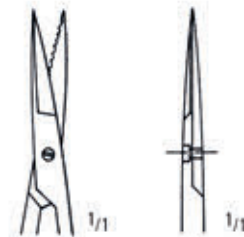



SCHEREN SCISSORS TIJERAS CISEAUX FORBICI

Mikroscheren  
Micro Scissors  
Micro Tijeras  
Micro Ciseaux  
Micro Forbici

AA  
AB  
AC  
AE  
AK  
AO  
AR  
KA  
KS  
XR  
XT



18,5 cm/7<sup>1</sup>/<sub>4</sub>"

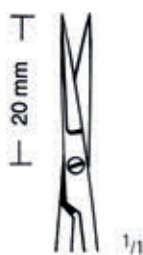

AC 850/19



AC 851/19



16,0 cm/6<sup>1</sup>/<sub>4</sub>"  
20,0 cm/8"  
22,5 cm/9"



AC 860/16  
AC 860/20  
AC 860/22



AC 861/16  
AC 861/20  
AC 861/22



AC 862/16  
AC 862/20  
AC 862/22



AC 863/16  
AC 863/20  
AC 863/22



AC 864/16  
AC 864/20  
AC 864/22



AC 865/16  
AC 865/20  
AC 865/22



**AC** SCHEREN SCISSORS TIJERAS CISEAUX FORBICI

Mikroscheren  
Micro Scissors  
Micro Tijeras  
Micro Ciseaux  
Micro Forbici



18,0 cm/7"



**AC 870/01**  
25°



**AC 870/02**  
45°



**AC 870/03**  
60°



**AC 870/04**  
90°



**AC 870/05**  
125°



18,0 cm/7"



**AC 871/01**  
25°



**AC 871/02**  
45°



**AC 871/03**  
60°



**AC 871/04**  
90°



**AC 871/05**  
125°

SCHEREN SCISSORS TIJERAS CISEAUX FORBICI

Scheren mit Hartmetalleinlagen  
 Scissors with Tungsten Carbide Inserts  
 Tijeras con filos de carburo de tungsteno  
 Ciseaux avec plaquettes en carbure de tungstène  
 Forbici con taglio al carburo di tungsteno

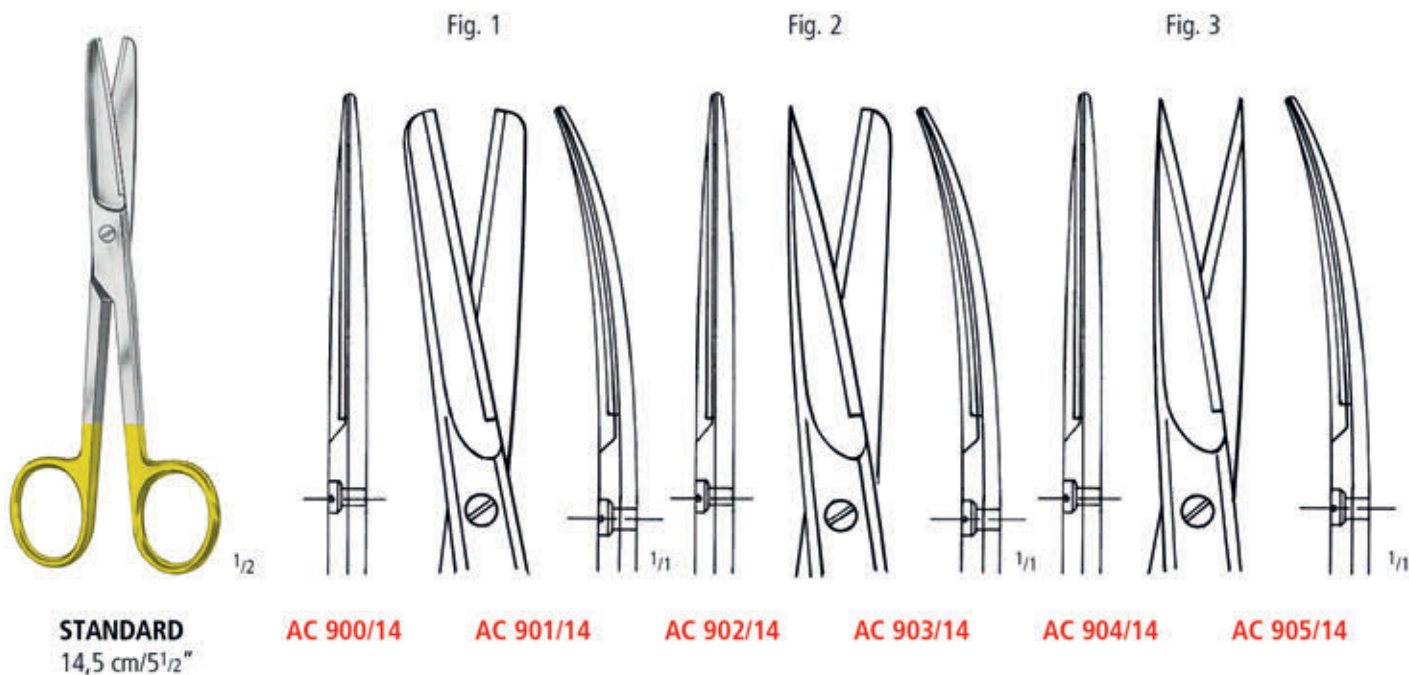

nopa®  
**TUC**



**MAYO**  
 AC 910/14 14,5 cm/5 1/2"  
 AC 910/17 17,0 cm/6 3/4"  
 AC 910/23 23,0 cm/9"

**MAYO**  
 AC 911/14  
 AC 911/17  
 AC 911/23

**METZENBAUM**  
 AC 930/14 14,5 cm/5 1/2"

**METZENBAUM**  
 AC 931/14 14,5 cm/5 1/2"

AA  
 AB  
 AC  
 AE  
 AK  
 AO  
 AR  
 KA  
 KS  
 XR  
 XT

**AC** SCHEREN SCISSORS TIJERAS CISEAUX FORBICI

Scheren mit Hartmetalleinlagen  
 Scissors with Tungsten Carbide Inserts  
 Tijeras con filos de carburo de tungsteno  
 Ciseaux avec plaquettes en carbure de tungstène  
 Forbici con taglio al carburo di tungsteno



Original 18,0 cm

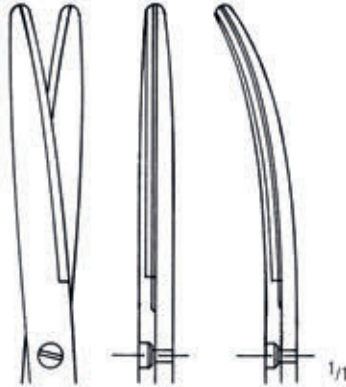

Original 20,0 cm

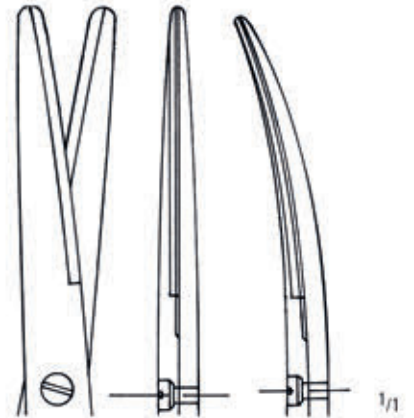

Original 23,0 cm



**METZENBAUM**



nopa®  
**TUC**

gerade  
 straight  
 rectas  
 droits  
 retta

gebogen  
 curved  
 curvas  
 courbes  
 curva

<b>AC 940/18</b>	18,0 cm/7"	<b>AC 941/18</b>
<b>AC 940/20</b>	20,0 cm/8"	<b>AC 941/20</b>
<b>AC 940/23</b>	23,0 cm/9"	<b>AC 941/23</b>
<b>AC 940/25</b>	25,0 cm/10"	<b>AC 941/25</b>
<b>AC 940/28</b>	28,0 cm/11"	<b>AC 941/28</b>
<b>AC 940/30</b>	30,0 cm/12"	<b>AC 941/30</b>

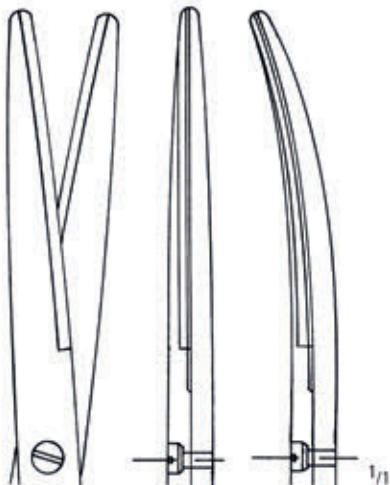

Original 25,0 cm

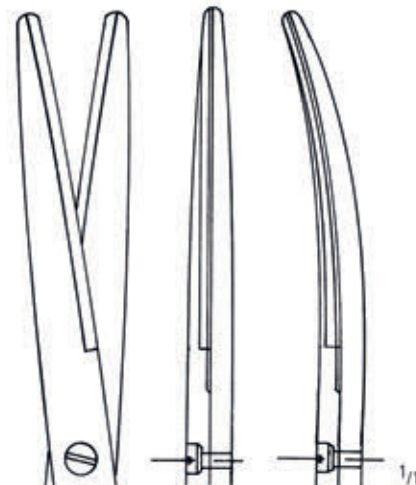

Original 28,0 cm

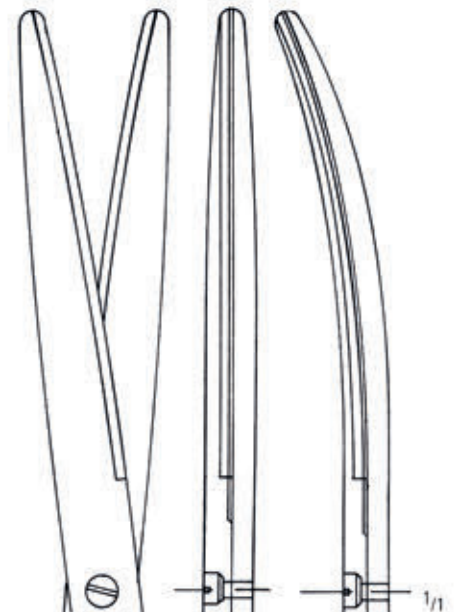

Original 30,0 cm



SCHEREN SCISSORS TIJERAS CISEAUX FORBICI

Scheren mit Hartmetalleinlagen  
 Scissors with Tungsten Carbide Inserts  
 Tijeras con filos de carburo de tungsteno  
 Ciseaux avec plaquettes en carbure de tungstène  
 Forbici con taglio al carburo di tungsteno



**LEXER**  
**AC 952/16**  
 16,0 cm/6<sup>1</sup>/<sub>4</sub>"

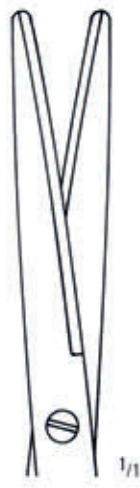

**LEXER**  
**AC 953/16**  
 16,0 cm/6<sup>1</sup>/<sub>4</sub>"



**AC 960/14**  
 14,5 cm/5<sup>1</sup>/<sub>2</sub>"



**AC 961/14**  
 14,5 cm/5<sup>1</sup>/<sub>2</sub>"

**METZENBAUM-DELICATE**



**AC 962/14**  
 14,5 cm/5<sup>1</sup>/<sub>2</sub>"



**AC 963/14**  
 14,5 cm /5<sup>1</sup>/<sub>2</sub>"

AA  
 AB  
**AC**  
 AE  
 AK  
 AO  
 AR  
 KA  
 KS  
 XR  
 XT



**AC** SCHEREN SCISSORS TIJERAS CISEAUX FORBICI

Scheren mit Hartmetalleinlagen  
 Scissors with Tungsten Carbide Inserts  
 Tijeras con fillos de carburo de tungsteno  
 Ciseaux avec plaquettes en carbure de tungstène  
 Forbici con taglio al carburo di tungsteno

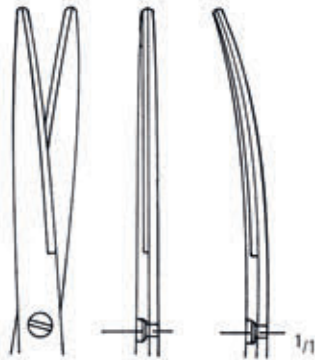

Original 18,0 cm

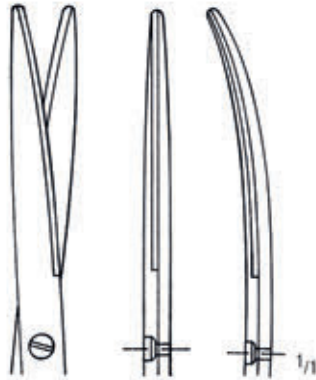

Original 20,0 cm

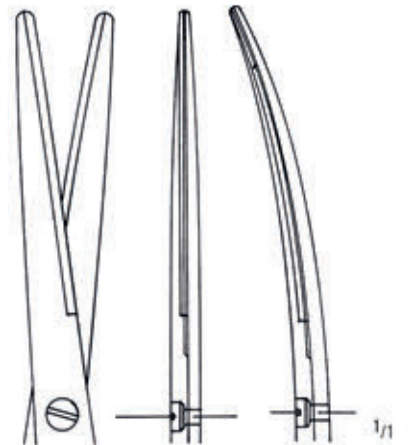

Original 23,0 cm



**METZENBAUM-DELICATE**

nopa®  
**TUC**

gerade  
 straight  
 rectas  
 droits  
 retta

gebogen  
 curved  
 curvas  
 courbes  
 curva

<b>AC 970/18</b>	18,0 cm/7"	<b>AC 971/18</b>
<b>AC 970/20</b>	20,0 cm/8"	<b>AC 971/20</b>
<b>AC 970/23</b>	23,0 cm/9"	<b>AC 971/23</b>
<b>AC 970/25</b>	25,0 cm/10"	<b>AC 971/25</b>
<b>AC 970/28</b>	28,0 cm/11"	<b>AC 971/28</b>

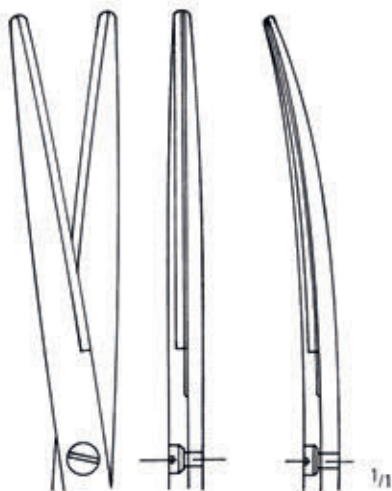

Original 25,0 cm

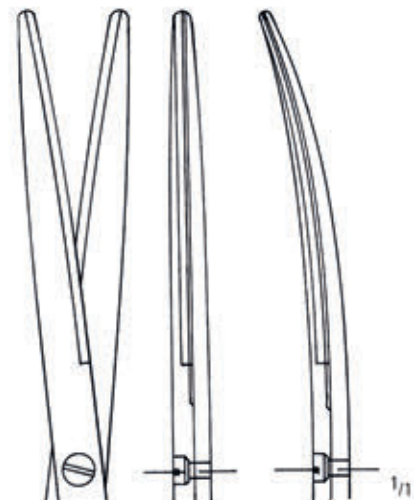

Original 28,0 cm

SCHEREN SCISSORS TIJERAS CISEAUX FORBICI

Scheren mit Hartmetalleinlagen  
 Scissors with Tungsten Carbide Inserts  
 Tijeras con filos de carburo de tungsteno  
 Ciseaux avec plaquettes en carbure de tungstène  
 Forbici con taglio al carburo di tungsteno



**TOENNIS-ADSON-DELICATE**  
**AC 977/17**  
 17,5 cm/7"



**AC 980/13**  
 13,0 cm/5"

**GOLDMAN-FOX**



**AC 981/13**  
 13,0 cm/5"



Weitere Scheren siehe Katalog A 98-157.  
 For further scissors see catalogue A 98-157.  
 Para otras tijeras ver catálogo A 98-157.  
 D'autres ciseaux voir notre catalogue A 98-157.  
 Altre forbici consultare il nostro catalogo A 98-157.



**AC 984/11**  
 11,5 cm/4 1/2"



**AC 985/11**  
 11,5 cm/4 1/2"

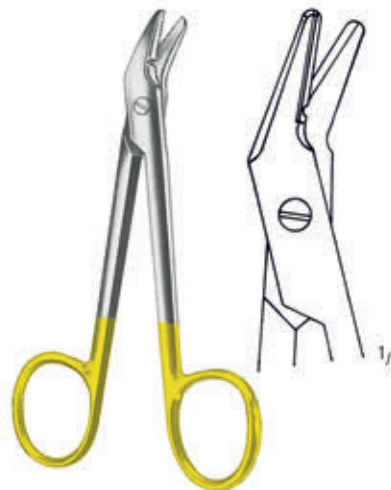

**UNIVERSAL**  
**AC 987/12**  
 12,0 cm/4 3/4"



**LISTER**  
**AC 999/18**  
 18,0 cm/7"

AA  
 AB  
**AC**  
 AE  
 AK  
 AO  
 AR  
 KA  
 KS  
 XR  
 XT



NAHT  
SUTURE  
SUTURA  
SUTURE  
SUTURA

AE

nopa<sup>®</sup> instruments





**AE** NAHT SUTURE SUTURA SUTURE SUTURA

Nadelhalter mit Hartmetalleinsätzen  
 Needle Holders with Tungsten Carbide Inserts  
 Porta-agujas con bocas de carburo de tungsteno  
 Porte-aiguilles à mors en carbure de tungstène  
 Portaghi con placche di carburo di tungsteno



**AE 400/14**  
14,0 cm/5½"



**AE 400/16**  
16,0 cm/6¼"



**AE 400/18**  
18,0 cm/7"



**AE 400/20**  
20,0 cm/8"



**AE 400/24**  
24,0 cm/9½"



**AE 400/26**  
26,0 cm/10¼"



**AE 400/30**  
30,0 cm/12"



**MAYO-HEGAR**



**AE 420/18**  
18,0 cm/7"



**AE 420/20**  
20,0 cm/8"



**AE 420/23**  
23,0 cm/9"



**AE 420/26**  
26,0 cm/10¼"



**AE 420/31**  
31,0 cm/12¼"

**DE BAKEY  
 (MAYO-HEGAR-DELICATE)**

NAHT SUTURE SUTURA SUTURE SUTURA

Nadelhalter mit Hartmetalleinsätzen  
 Needle Holders with Tungsten Carbide Inserts  
 Porta-agujas con bocas de carburo de tungsteno  
 Porte-aiguilles à mors en carbure de tungstène  
 Portaghi con placche di carburo di tungsteno



**MICRO RYDER**

- |   |   |   |   |   |   |
|---|---|---|---|---|---|
|  |  |  |  |  |  |
| <b>AE 434/13</b><br>13,0 cm/5"  | <b>AE 434/15</b><br>15,0 cm/6"  | <b>AE 434/18</b><br>18,0 cm/7"  | <b>AE 434/20</b><br>20,0 cm/8"  | <b>AE 434/23</b><br>23,0 cm/9"  | <b>AE 434/26</b><br>26,0 cm/10 <sup>1</sup> / <sub>4</sub> "                        |



**CONVERSE**  
**AE 452/12**  
 12,5 cm/5"



**NEIVERT**  
**AE 456/13**  
 13,0 cm/5"



**HALSEY**  
 13,0 cm/5"

AA  
AB  
AC  
AE  
AK  
AO  
AR  
KA  
KS  
XR  
XT

**AE** NAHT SUTURE SUTURA SUTURE SUTURA

Nadelhalter mit Hartmetalleinsätzen  
 Needle Holders with Tungsten Carbide Inserts  
 Porta-agujas con bocas de carburo de tungsteno  
 Porte-aiguilles à mors en carbure de tungstène  
 Portaghi con placche di carburo di tungsteno



**BABY-CRILE-WOOD**  
**AE 468/15**  
 15,0 cm/6"



**CRILE-WOOD**  
**AE 469/15**  
 15,0 cm/6"



**CRILE-WOOD**  
**AE 470/15**  
 15,0 cm/6"



**CRILE-WOOD**



**AE 470/18**  
 18,0 cm/7"



**AE 470/20**  
 20,0 cm/8"



**AE 470/23**  
 23,0 cm/9"



**AE 471/18**  
 18,0 cm/7"



**AE 471/23**  
 23,0 cm/9"

nopa<sup>®</sup>  
**TUC**

NAHT SUTURE SUTURA SUTURE SUTURA

Nadelhalter mit Hartmetalleinsätzen  
 Needle Holders with Tungsten Carbide Inserts  
 Porta-agujas con bocas de carburo de tungsteno  
 Porte-aiguilles à mors en carbure de tungstène  
 Portaghi con placche di carburo di tungsteno

AA  
AB  
AC  
AE  
AK  
AO  
AR  
KA  
KS  
XR  
XT



MATHIEU



AE 500/14  
14,0 cm/5 1/2"



AE 500/17  
17,0 cm/6 3/4"



AE 500/20  
20,0 cm/8"



AE 500/24  
24,0 cm/9 1/2"



MATHIEU-DELICATE



AE 504/14  
14,0 cm/5 1/2"



AE 504/17  
17,0 cm/6 3/4"



AE 504/20  
20,0 cm/8"



MATHIEU-RYDER MICRO



AE 512/17  
17,0 cm/6 3/4"



AE 512/20  
20,0 cm/8"



LANGENBECK



AE 540/16  
16,0 cm/6 1/4"



AE 540/18  
18,0 cm/7"



AE 540/20  
20,0 cm/8"



**AE** NAHT SUTURE SUTURA SUTURE SUTURA

Nadelhalter mit Hartmetalleinsätzen  
 Needle Holders with Tungsten Carbide Inserts  
 Porta-agujas con bocas de carburo de tungsteno  
 Porte-aiguilles à mors en carbure de tungstène  
 Portaghi con placche di carburo di tungsteno



**CASTROVIEJO**  
 14,0 cm/5 1/2"



**CASTROVIEJO**  
 14,0 cm/5 1/2"



18,0 cm/7"



**JACOBSON**  
 21,0 cm/8 1/4"



NAHT SUTURE SUTURA SUTURE SUTURA

Mikro-Nadelhalter mit Rundgriff  
 Micro-Needle Holders with pen-type handle  
 Micro-porta-agujas con mango redondo  
 Micro-porte-aiguilles à manches rondes  
 Micro-portaghi con manici rotondi



**AE 630/18**  
 18,0 cm/7<sup>1</sup>/<sub>4</sub>"



**AE 631/18**  
 18,0 cm/7<sup>1</sup>/<sub>4</sub>"



**AE 632/18**  
 18,0 cm/7<sup>1</sup>/<sub>4</sub>"



**AE 633/18**  
 18,0 cm/7<sup>1</sup>/<sub>4</sub>"

AA  
 AB  
 AC  
**AE**  
 AK  
 AO  
 AR  
 KA  
 KS  
 XR  
 XT

Mikro-Nadelhalter  
 Micro-Needle-Holders  
 Micro-porta-agujas  
 Micro-porte-aiguilles  
 Micro-portaghi



**JACOBSON**  
**AE 678/18**  
 18,0 cm/7"



**AE 680/16**  
**AE 680/18**  
**AE 680/20**  
**AE 680/22**

16,0 cm/6 1/2"  
 18,0 cm/7"  
 20,0 cm/8"  
 22,0 cm/9"



**AE 681/16**  
**AE 681/18**  
**AE 681/20**  
**AE 681/22**

Weitere Nadelhalter siehe Katalog A 176-209 und Gruppe KS.  
 For further needle holders see catalogue A 176-209 and section KS.  
 Para otras porta-agujas ver catálogo A 176-209 y sección KS.  
 D'autres porte-aiguilles voir notre catalogue A 176-209 et groupe KS.  
 Per altri portaghi consultare il nostro catalogo A 176-209 e gruppo KS.

WUNDHAKEN  
RETRACTORS  
SEPARADORES  
ECARTEURS  
DIVARICATORI

**AK**

**nopa**<sup>®</sup> instruments



Feine Wundhaken  
 Delicate Hooks  
 Ganchos  
 Crochets très fins  
 Divaricatori sottili



**GILLIES**  
**AK 020/01**  
 18,0 cm/7"



**GILLIES**  
**AK 020/02**  
 18,0 cm/7"



**KILNER**  
**AK 022/15**  
 15,0 cm/6"



**FRAZIER**  
**AK 024/13**  
 13,0 cm/5"



**AK 026/01**



**KLEINERT-KUTZ**  
**AK 026/02**  
 16,0 cm/6¼"



**AK 026/03**



Feine Wundhaken  
Delicate Hooks  
Ganchos  
Crochets très fins  
Divaricatori sottili

AA  
AB  
AC  
AE  
AK  
AO  
AR  
KA  
KS  
XR  
XT



**CUSHING**  
28,0 cm/11"



**AK 034/01**



**AK 034/02**



**CUSHING**  
19,0 cm/7<sup>1</sup>/<sub>4</sub>"



**AK 036/01**



**AK 036/02**



**MOLDESTAD**  
**AK 038/13**  
13,0 cm/5"



**AK 040/05**  
5 mm



**AK 040/07**  
7 mm

17,0 cm/6<sup>3</sup>/<sub>4</sub>"



**AK 042/10**  
Ø 1,0 mm



**AK 042/12**  
Ø 1,2 mm



18,5 cm/7<sup>1</sup>/<sub>4</sub>"

Weitere feine Wundhaken siehe Gruppe KS.  
For further delicate hooks see section KS.  
Para otros ganchos ver sección KS.  
D'autres crochets très fins voir groupe KS.  
Per altri divaricatori sottili vedi gruppo KS.



**AK 044/11**  
11,0 cm/4<sup>1</sup>/<sub>4</sub>"

Spinalhaken  
 Spinal Retractors  
 Separadores espinales  
 Ecarteurs spinals  
 Divaricatori spinali



**CUSHING**  
**AK 130/20**  
 20,0 cm/8"



**TAYLOR**  
 16,5 cm/6 1/2"

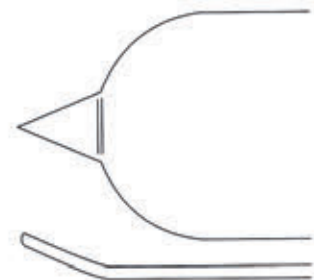

**AK 132/07**  
 75 x 30 mm

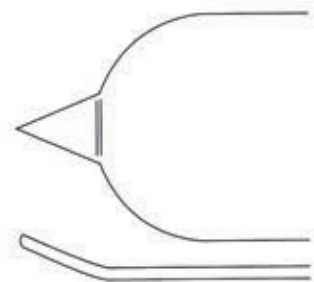

**AK 132/10**  
 100 x 30 mm



**MEYERDING**  
22,5 cm/9"

**AK** WUNDHAKEN RETRACTORS SEPARADORES ECARTEURS DIVARICATORI

Selbsthaltende Wundsperrer  
 Selfretaining Retractors  
 Separadores autoestaticos  
 Ecarteurs autostatiques  
 Divaricatori autostatici



**ALM**

- |   |   |
|---|---|
| <p>^ 7,0 cm/2<sup>3</sup>/<sub>4</sub>"<br/>                 AK 506/07</p> <p>o 7,0 cm/2<sup>3</sup>/<sub>4</sub>"<br/>                 AK 507/07</p> | <p>^ 10,0 cm/4"<br/>                 AK 506/10</p> <p>o 10,0 cm/4"<br/>                 AK 507/10</p> |
|---|---|



**JANSEN**

- |                                       |  |
|---------------------------------------|--|
| <p>^ AK 510/10</p> <p>o AK 511/10</p> |  |
| 10,0 cm/4"                            |  |



**JANSEN**

- |                                       |  |
|---------------------------------------|--|
| <p>^ AK 512/10</p> <p>o AK 513/10</p> |  |
| 10,0 cm/4"                            |  |



**SNITMAN**

- |   |  |
|---|--|
| <p>^ AK 514/10</p> <p>o AK 515/10</p>   |  |
| 10,5 cm/4 <sup>1</sup> / <sub>4</sub> " |  |



WUNDHAKEN RETRACTORS SEPARADORES ECARTEURS DIVARICATORI

Selbsthaltende Wundsperrer  
Selfretaining Retractors  
Separadores autoestaticos  
Ecarteurs autostatiques  
Divaricatori autostatici



**WEITLANER**

10,5 cm/4 1/4"  
13,0 cm/5"  
16,5 cm/6 1/2"  
20,0 cm/8"  
25,0 cm/10"  
26,0 cm/10 1/2"

2 x 3  
3 x 4  
3 x 4  
3 x 4  
3 x 4  
5 x 6

AK 522/10  
AK 524/13  
AK 526/16  
AK 528/20  
AK 530/25  
AK 532/26

AK 523/10  
AK 525/13  
AK 527/16  
AK 529/20  
AK 531/25  
AK 533/26



**ANDERSON-ADSON**

AK 556/20      AK 557/20  
20,0 cm/8"

AA  
AB  
AC  
AE  
AK  
AO  
AR  
KA  
KS  
XR  
XT

Selbsthaltende Wundsperr  
 Selfretaining Retractors  
 Separadores autoestaticos  
 Ecarteurs autostatiques  
 Divaricatori autostatici



**ADSON**  
**AK 560/27**  
 27,0 cm/10<sup>1</sup>/<sub>2</sub>"



**ADSON - R**  
**AK 561/01**  
 27,0 cm/10<sup>1</sup>/<sub>2</sub>"



**ADSON - L**  
**AK 561/02**  
 27,0 cm/10<sup>1</sup>/<sub>2</sub>"

WUNDHAKEN RETRACTORS SEPARADORES ECARTEURS DIVARICATORI

Selbsthaltende Wundsperrer  
Selfretaining Retractors  
Separadores autoestaticos  
Ecarteurs autostatiques  
Divaricatori autostatici



**CONE**

13,0 cm/5"	3 x 4
16,5 cm/6 1/2"	3 x 4
20,0 cm/8"	3 x 4
25,0 cm/10"	3 x 4



**AK 564/13**  
**AK 564/16**  
**AK 564/20**  
**AK 564/25**



**AK 565/13**  
**AK 565/16**  
**AK 565/20**  
**AK 565/25**



**BECKMANN**

31,0 cm/12"
33,0 cm/13"

4 x 4
4 x 5



**AK 566/31**  
**AK 568/33**



**AK 567/31**  
**AK 569/33**

AA  
AB  
AC  
AE  
**AK**  
AO  
AR  
KA  
KS  
XR  
XT

Selbsthaltende Wundsperrer  
 Selfretaining Retractors  
 Separadores autoestaticos  
 Ecarteurs autostatiques  
 Divaricatori autostatici



25 x 25 mm  
 25 x 31 mm  
 25 x 40 mm  
 25 x 45 mm



AK 570/01  
 AK 570/02  
 AK 570/03  
 AK 570/04



AK 571/01  
 AK 571/02  
 AK 571/03  
 AK 571/04

**BECKMANN-ADSON**  
 31,0 cm/12"



**BECKMANN-EATON**

AK 572/33      AK 573/33  
 33,0 cm/13"



Selbsthaltende Wundsperrer  
Selfretaining Retractors  
Separadores autoestáticos  
Ecarteurs autostatiques  
Divaricatori autostatici



**SCALP-CONTOUR**  
AK 574/14      AK 575/14  
14,0 cm/5 1/2"

Weitere Wundhaken siehe Katalog A 239-294 und Gruppe KS.  
For further retractors see catalogue A 239-294 and section KS.  
Para otros separadores ver catálogo A 239-294 y sección KS.  
D'autres écarteurs voir notre catalogue A 239-294 et groupe KS.  
Per altri divaricatori consultare il nostro catalogo A 239-294 e gruppo KS.

AA

AB

AC

AE

AK

AO

AR

KA

KS

XR

XT



PUNKTION/KANÜLEN  
PUNCTURE/SPECIAL NEEDLES  
PUNCION/AGUJAS ESPECIALES  
PUNCTION/AIGUILLES SPECIALES  
PUNTURA/AGHI SPECIALI

A0

nopa<sup>®</sup> instruments



Saugrohre  
Suction Tubes  
Tubos de aspiración  
Canules d'aspiration  
Cannule di aspirazione



complete with suction tube  
+ cannula 0,4 mm  
+ cannula 0,6 mm  
+ cannula 0,8 mm

**FRAZIER**

- 6 Charr. **AO 430/06**
- 8 Charr. **AO 430/08**
- 10 Charr. **AO 430/10**
- 12 Charr. **AO 430/12**

**PLESTER**

- 1,5 mm **AO 432/15**
- 2,0 mm **AO 432/20**
- 2,5 mm **AO 432/25**
- 3,0 mm **AO 432/30**

**FERGUSSON**

- 5 Charr. **AO 434/05**
- 6 Charr. **AO 434/06**
- 7 Charr. **AO 434/07**
- 8 Charr. **AO 434/08**
- 9 Charr. **AO 434/09**
- 10 Charr. **AO 434/10**
- 12 Charr. **AO 434/12**

**WULLSTEIN**

- MICRO**
- AO 438/00**

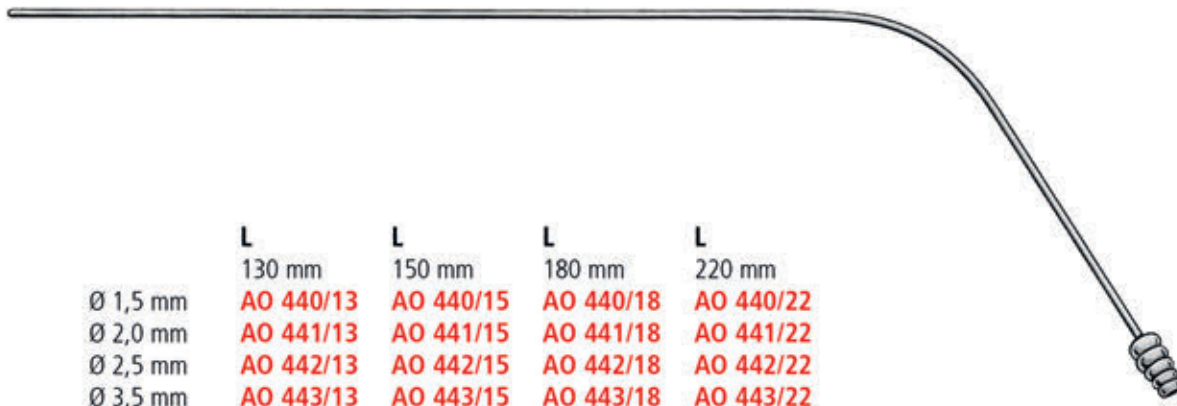
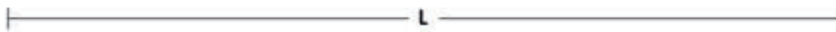

- |          | <b>L</b>         | <b>L</b>         | <b>L</b>         | <b>L</b>         |
|----------|------------------|------------------|------------------|------------------|
|          | 130 mm           | 150 mm           | 180 mm           | 220 mm           |
| Ø 1,5 mm | <b>AO 440/13</b> | <b>AO 440/15</b> | <b>AO 440/18</b> | <b>AO 440/22</b> |
| Ø 2,0 mm | <b>AO 441/13</b> | <b>AO 441/15</b> | <b>AO 441/18</b> | <b>AO 441/22</b> |
| Ø 2,5 mm | <b>AO 442/13</b> | <b>AO 442/15</b> | <b>AO 442/18</b> | <b>AO 442/22</b> |
| Ø 3,5 mm | <b>AO 443/13</b> | <b>AO 443/15</b> | <b>AO 443/18</b> | <b>AO 443/22</b> |



**ADSON**

- AO 450/04**
- 21,0 cm/8<sup>1</sup>/<sub>4</sub>"
- 4,0 mm

DIAGNOSTIK  
DIAGNOSTICS  
DIAGNOSTICO  
DIAGNOSTIC  
DIAGNOSTICA

AR

nopa<sup>®</sup> instruments





Perkussionshämmer  
 Percussion Hammers  
 Martillos de percusión  
 Marteaux-percuteurs  
 Martelli percussori



**BUCK**  
 AR 200/18  
 18,0 cm/7"

**BABINSKY**  
 AR 205/22  
 22,0 cm/8<sup>3</sup>/<sub>4</sub>"  
 Ø 40 mm

**RABINER**  
 AR 208/23  
 23,0 cm/9"  
 Ø 40 mm

**TAYLOR**  
 18,0 cm/7" AR 215/18  
 20,0 cm/8" AR 215/20

DIAGNOSTIK DIAGNOSTICS DIAGNOSTICO DIAGNOSTIC DIAGNOSTICA

Perkussionshämmer  
 Percussion Hammers  
 Martillos de percusión  
 Marteaux-percuteurs  
 Martelli percussori

AA  
 AB  
 AC  
 AE  
 AK  
 AO  
 AR  
 KA  
 KS  
 XR  
 XT



**TROEMNER**  
 AR 216/24  
 24,0 cm/9<sup>1</sup>/<sub>2</sub>"



**DÉJERINE**  
 AR 217/20  
 20,0 cm/8"



**DÉJERINE**  
 AR 218/20  
 20,0 cm/8"

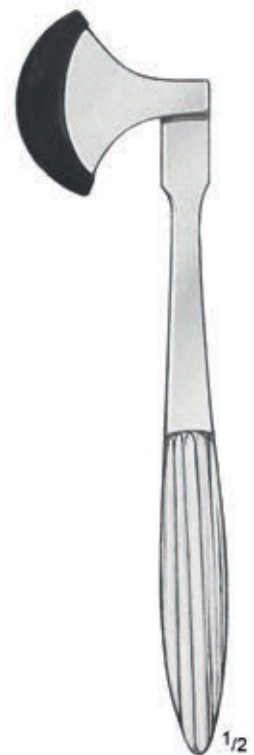

**BERLINER**  
 AR 220/20  
 20,0 cm/8"

**AR** DIAGNOSTIK DIAGNOSTICS DIAGNOSTICO DIAGNOSTIC DIAGNOSTICA

Sensibilitäts-Instrumente  
Sensitivity Instruments  
Instrumentos sensibilidad  
Instruments sensibilités  
Strumenti per sensibilità



**ALY**  
**AR 300/00**  
19,0 cm/7 1/2"



**WARTENBERG**  
**AR 301/00**  
19,0 cm/7 1/2"

ORTHOPÄDIE  
ORTHOPAEDICS  
ORTOPEDIA  
ORTHOPEDIE  
ORTOPEDIA

KA

nopa<sup>®</sup> instruments



Handbohrapparate  
Hand Drills  
Perforadores de mano  
Perforateurs à main  
Perforatori a mano



← **KA 060/90**

**STILLE**  
**KA 060/00**  
20,0 cm/8"

komplett mit  
complete with  
completo con  
complet avec  
completo con

Fig. 1-9  
Fig. 1-9  
Fig. 1-9  
Fig. 1-9  
Fig. 1-9



Fig. 1  
**KA 060/01**  
Ø 2,5 mm



Fig. 2  
**KA 060/02**  
Ø 3,0 mm



Fig. 3  
**KA 060/03**  
Ø 3,5 mm



Fig. 4  
**KA 060/04**  
Ø 4,0 mm



Fig. 5  
**KA 060/05**  
Ø 10,0 mm



Fig. 6  
**KA 060/06**  
Ø 5,0 mm



Fig. 7  
**KA 060/07**  
Ø 8,0 mm



Fig. 8  
**KA 060/08**  
Ø 12,0 mm



Fig. 9  
**KA 060/09**  
Ø 16,0 mm



Fig. 10  
**KA 060/10**  
Ø 1,0 mm



Fig. 11  
**KA 060/11**  
Ø 1,5 mm



Fig. 12  
**KA 060/12**  
Ø 2,0 mm



Handbohrapparate  
Hand Drills  
Perforadores de mano  
Perforateurs à main  
Perforatore a mano



**RALK**  
**KA 100/00**



Ø 1,0 mm	<b>KA 102/10</b>
Ø 1,5 mm	<b>KA 102/15</b>
Ø 2,0 mm	<b>KA 102/20</b>
Ø 2,7 mm	<b>KA 102/27</b>
Ø 3,0 mm	<b>KA 102/30</b>
Ø 3,2 mm	<b>KA 102/32</b>
Ø 3,5 mm	<b>KA 102/35</b>
Ø 4,0 mm	<b>KA 102/40</b>
Ø 4,5 mm	<b>KA 102/45</b>
Ø 5,0 mm	<b>KA 102/50</b>
Ø 6,0 mm	<b>KA 102/60</b>
Ø 8,0 mm	<b>KA 102/80</b>

AA  
AB  
AC  
AE  
AK  
AO  
AR  
**KA**  
KS  
XR  
XT



Maßtabelle  
 Scale  
 Tabla de medida  
 Tableau de la mesure  
 Scala

AA  
 AB  
 AC  
 AE  
 AK  
 AO  
 AR  
 KA  
 KS  
 XR  
 XT



2,0 mm



3,0 mm



4,0 mm



5,0 mm



6,0 mm



8,0 mm



10,0 mm



12,0 mm



14,0 mm



16,0 mm



18,0 mm



20,0 mm



25,0 mm



30,0 mm



35,0 mm



40,0 mm



45,0 mm



50,0 mm



KA



KS



XR



XT

Meißel und Osteotome  
 Chisels, Gouges and Osteotomes  
 Cinceles y Gubias  
 Ciseaux-Burins et Ostéotomes  
 Scalpelli, Osteotomi, Sgorbie



**MINI-LEXER**  
 18,0 cm/7"



**MINI-LEXER**  
 18,0 cm/7"



**LEXER**  
 22,0 cm/8<sup>3</sup>/<sub>4</sub>"



**LEXER**  
 22,0 cm/8<sup>3</sup>/<sub>4</sub>"

mm  
 4  
 6  
 7  
 8  
 10  
 12  
 15  
 20  
 25  
 30

**KA 470/04**  
**KA 470/06**  
**KA 470/08**  
**KA 470/10**  
**KA 470/12**  
**KA 470/15**  
**KA 470/20**

**KA 471/04**  
**KA 471/06**  
**KA 471/08**  
**KA 471/10**  
**KA 471/12**  
**KA 471/15**  
**KA 471/20**

**KA 472/07**  
**KA 472/10**  
**KA 472/15**  
**KA 472/20**  
**KA 472/25**  
**KA 472/30**

**KA 473/07**  
**KA 473/10**  
**KA 473/15**  
**KA 473/20**  
**KA 473/25**  
**KA 473/30**

Ferrozellgriff  
 Hartpress-Handle  
 Mango en "Ferrozell"  
 Manche en "Ferrozell"  
 Manico in "Ferrozell"

Meißel und Osteotome  
 Chisels, Gouges and Osteotomes  
 Cinceles y Gubias  
 Ciseaux-Burins et Ostéotomes  
 Scalpelli, Osteotomi, Sgorbie

AA  
 AB  
 AC  
 AE  
 AK  
 AO  
 AR  
**KA**  
 KS  
 XR  
 XT



**LEXER**  
 27,5 cm/10<sup>3</sup>/<sub>4</sub>"

- mm  
 5  
 10 **KA 474/10**  
 15 **KA 474/15**



**LEXER**  
 27,5 cm/10<sup>3</sup>/<sub>4</sub>"

- KA 475/10**  
**KA 475/15**



**LEXER**  
 25,0 cm/10"

- KA 476/05**  
**KA 476/10**  
**KA 476/15**



**LEXER**  
 25,0 cm/10"

- KA 477/05**  
**KA 477/10**  
**KA 477/15**

Ferrozellgriff  
 Hartpress-Handle  
 Mango en "Ferrozell"  
 Manche en "Ferrozell"  
 Manico in "Ferrozell"



Meißel und Osteotome  
 Chisels, Gouges and Osteotomes  
 Cinceles y Gubias  
 Ciseaux-Burins et Ostéotomes  
 Scalpelli, Osteotomi, Sgorbie

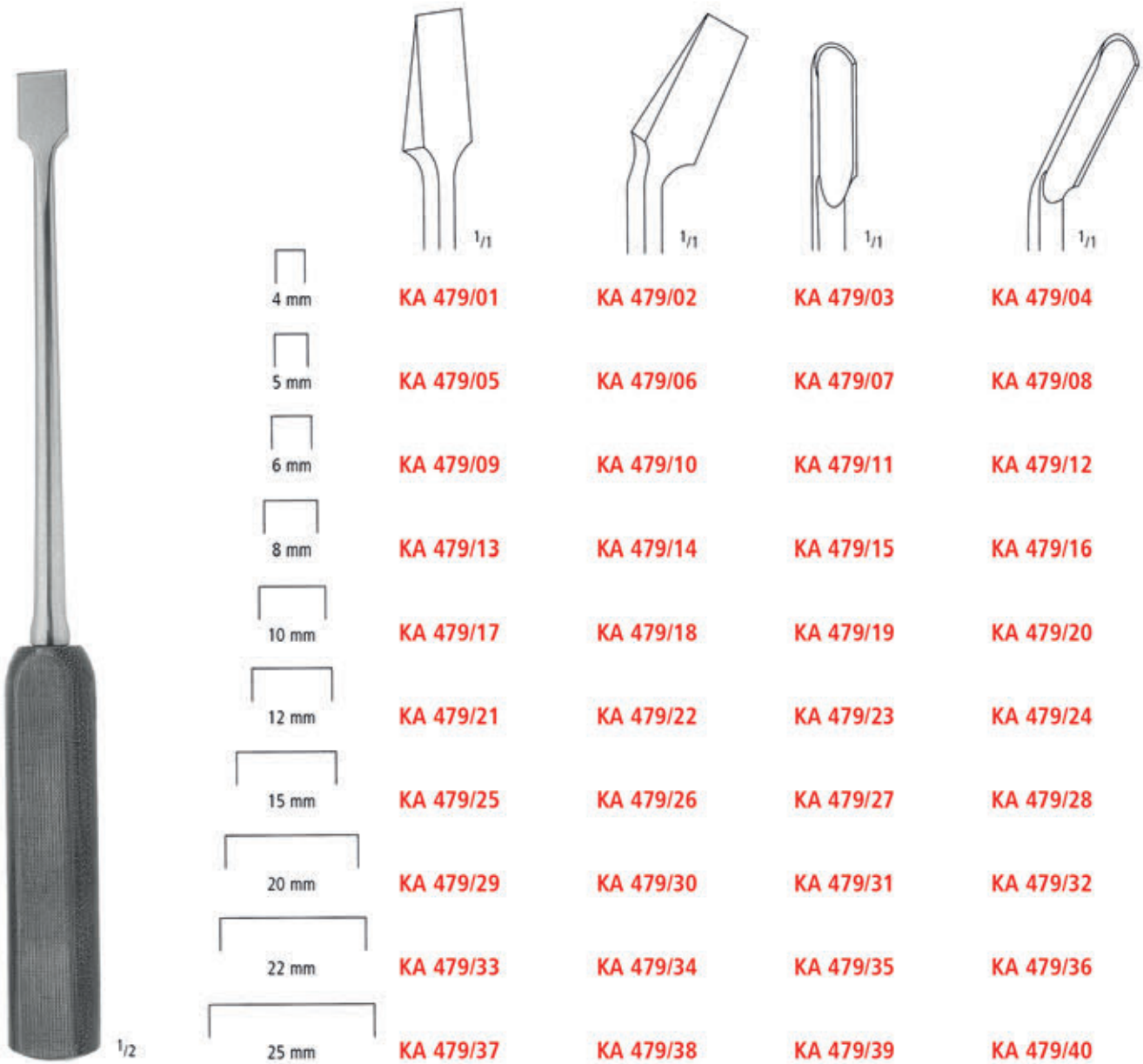

**DAHMEN**

30,0 cm/12"

Ferrozellgriff  
 Hartpress-Handle  
 Mango en "Ferrozell"  
 Manche en "Ferrozell"  
 Manico in "Ferrozell"

Hämmer  
Mallets  
Martillos  
Marteaux  
Martelli

AA

AB

AC

AE

AK

AO

AR

KA

KS

XR

XT



**OMBREDANNE**  
**KA 519/55**  
24,0 cm/9 1/2"



**COTTLE**  
**KA 531/24**  
19,0 cm/7 1/2"

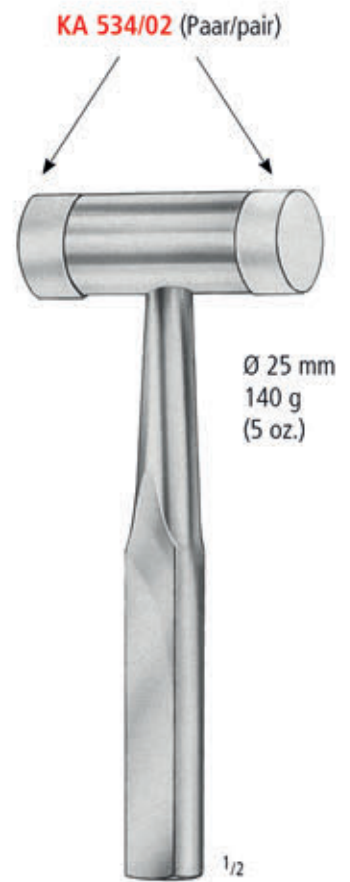

**KA 534/14**  
18,0 cm/7"

Hämmer  
Mallets  
Martillos  
Marteaux  
Martelli



KA 554/90

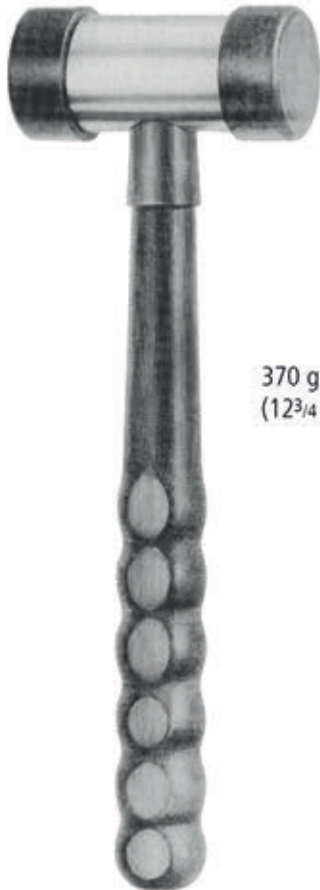

370 g  
(12<sup>3</sup>/<sub>4</sub> oz.)

KA 554/37  
Ferrozell



125 g  
(4<sup>1</sup>/<sub>4</sub> oz.)

KA 555/13  
Ferrozell

Scharfe Löffel  
 Bone Curettes  
 Cucharillas cortantes  
 Curettes tranchantes  
 Curette taglienti

AA  
 AB  
 AC  
 AE  
 AK  
 AO  
 AR  
 KA  
 KS  
 XR  
 XT



**CLOWARD  
 HIBBS SPRATT  
 SPINAL FUSION**  
 22,5 cm/9"

Fig. 000  
**KA 626/00**

Fig. 00  
**KA 627/00**

Fig. 0  
**KA 628/00**

Fig. 1  
**KA 628/01**

Fig. 2  
**KA 628/02**

Fig. 3  
**KA 628/03**

Fig. 4  
**KA 628/04**

Fig. 5  
**KA 628/05**

Fig. 6  
**KA 628/06**



**CLOWARD  
 HIBBS SPRATT  
 SPINAL FUSION**  
 22,5 cm/9"

Fig. 000  
**KA 629/00**

Fig. 00  
**KA 630/00**

Fig. 0  
**KA 631/00**

Fig. 1  
**KA 631/01**

Fig. 2  
**KA 631/02**

Fig. 3  
**KA 631/03**

Fig. 4  
**KA 631/04**

Fig. 5  
**KA 631/05**

Fig. 6  
**KA 631/06**

Elevatoren  
Elevators  
Elevadores  
Elévateurs  
Elevatori



**LANGENBECK**  
19,5 cm/7<sup>3</sup>/<sub>4</sub>"



**FREER**  
19,0 cm/7<sup>1</sup>/<sub>2</sub>"



**FREER**  
**KA 703/18**  
18,0 cm/7"



Elevatori  
Elevators  
Elevadores  
Elévateurs  
Elevatori

AA  
AB  
AC  
AE  
AK  
AO  
AR  
KA  
KS  
XR  
XT



**HOEN**

7 mm



**KA 704/07**  
16,0 cm/6 1/4"

15 mm



**KA 704/15**  
19,0 cm/7 1/2"

20 mm



**KA 704/20**  
19,0 cm/7 1/2"



**ADSON**  
17,0 cm/6 3/4"



**KA 705/01**



**KA 705/02**



**KA 705/03**



**KA 705/04**

Hohlmeisselzangen  
 Bone Rongeurs  
 Pinzas-gubias  
 Pincès-gouges  
 Pinze-sgorbie

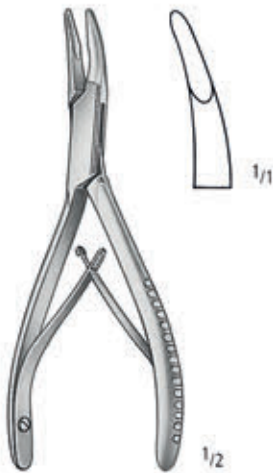

**MINI-FRIEDMAN**  
**KA 800/12**  
 12,0 cm/5"

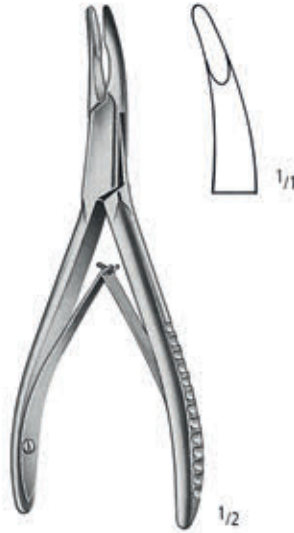

**FRIEDMAN**  
**KA 800/14**  
 14,0 cm/5½"

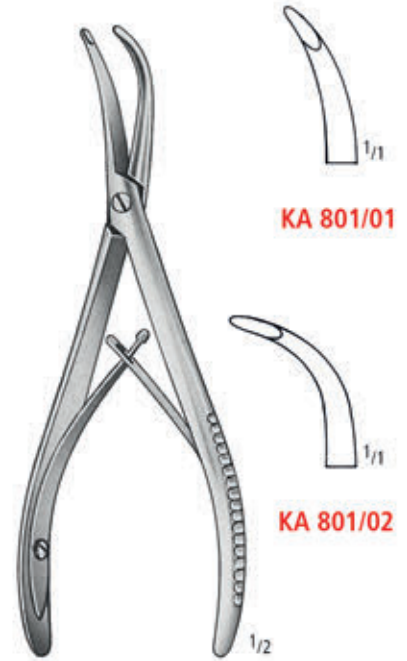

**STELLBRINK**  
 17,0 cm/6¾"

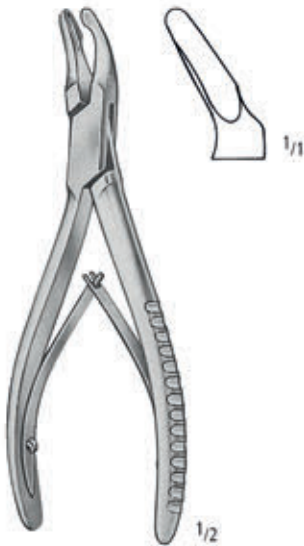

**CLEVELAND**  
**KA 802/14**  
 14,0 cm/5½"

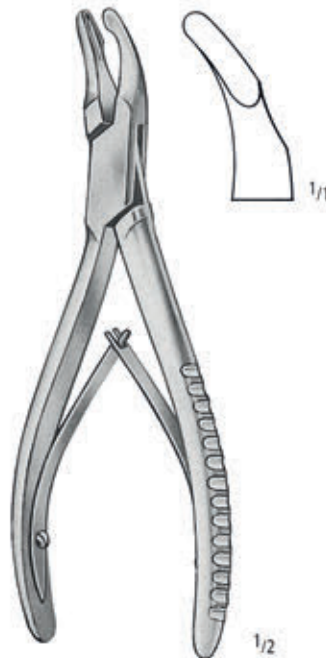

**CLEVELAND**  
**KA 802/17**  
 17,0 cm/6¾"

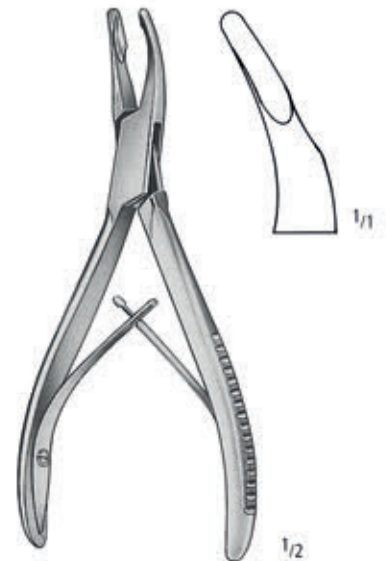

**UNIVERSAL**  
**KA 803/13**  
 13,5 cm/5¼"

Hohlmeisselzangen  
 Bone Rongeurs  
 Pinzas-gubias  
 Pincès-gouges  
 Pinze-sgorbie

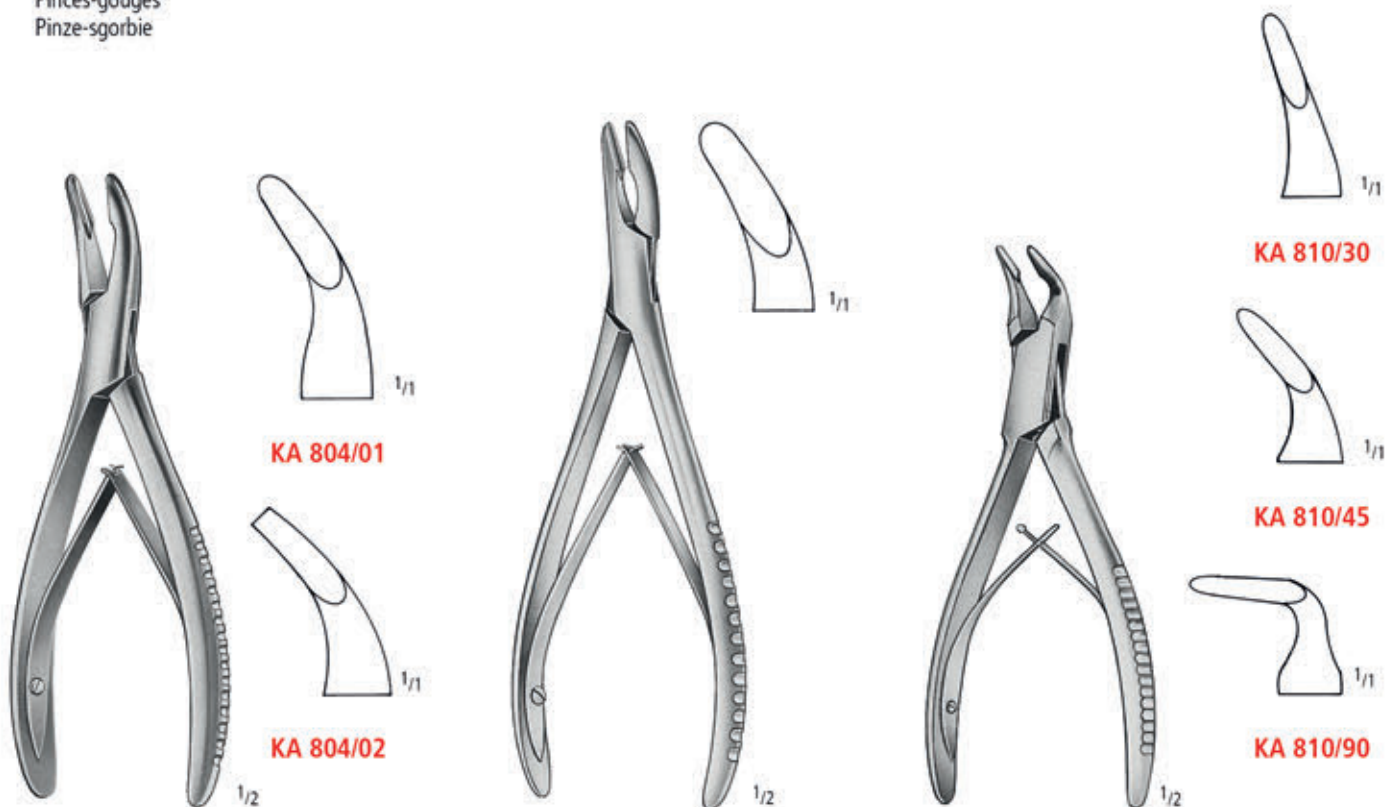

KA 804/01

KA 804/02

KA 810/30

KA 810/45

KA 810/90

**MEAD**

16,5 cm/6 1/2"

**HARTMANN**

KA 807/18

18,5 cm/7 1/4"

**BLUMENTHAL**

15,5 cm/6"

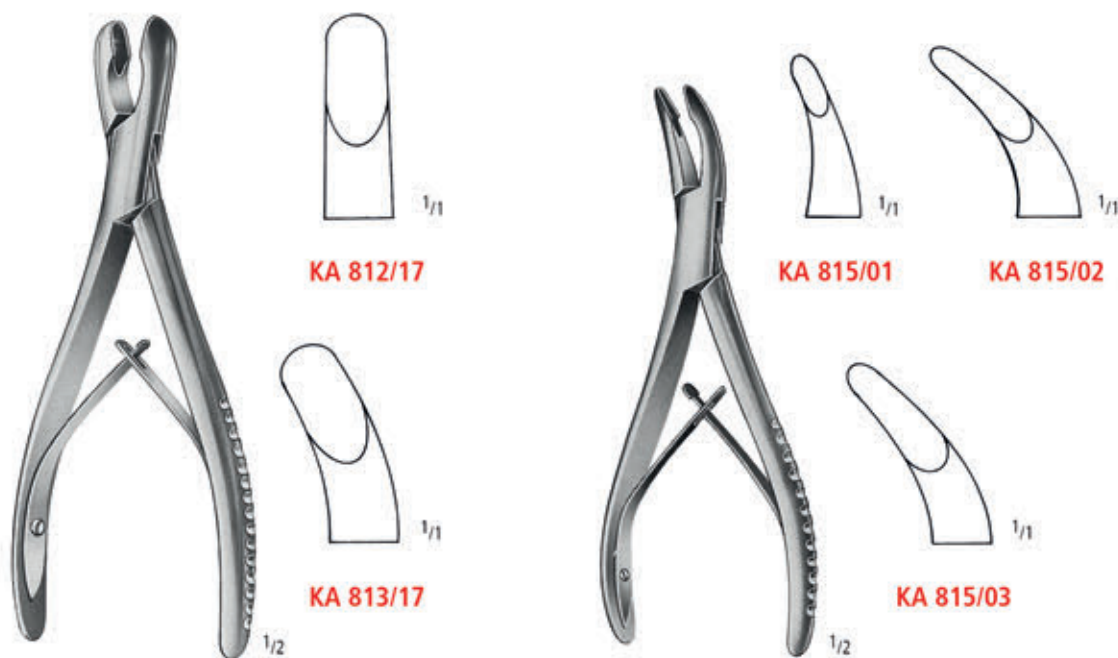

KA 812/17

KA 813/17

KA 815/01

KA 815/02

KA 815/03

**LUER**

17,0 cm/6 3/4"

**LUER**

15,0 cm/6"

AA  
AB  
AC  
AE  
AK  
AO  
AR  
KA  
KS  
XR  
XT

Hohlmeisselzangen  
 Bone Rongeurs  
 Pinzas-gubias  
 Pincis-gouges  
 Pinze-sgorbie



**LEMPERT**  
**KA 816/19**  
 19,0 cm/7 1/2"



**BACON**  
**KA 819/20**  
 20,0 cm/8"



**MARQUARDT**  
**KA 821/20**  
 20,0 cm/8"

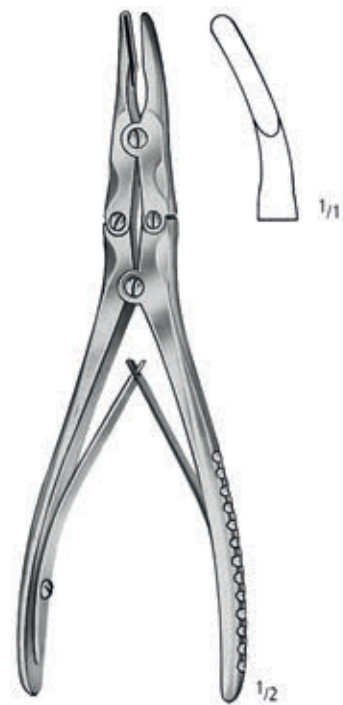

**MAYFIELD**  
**KA 823/17**  
 17,0 cm/6 3/4"



Hohlmeisselzangen  
 Bone Rongeurs  
 Pinzas-gubias  
 Pincas-gouges  
 Pinze-sgorbie

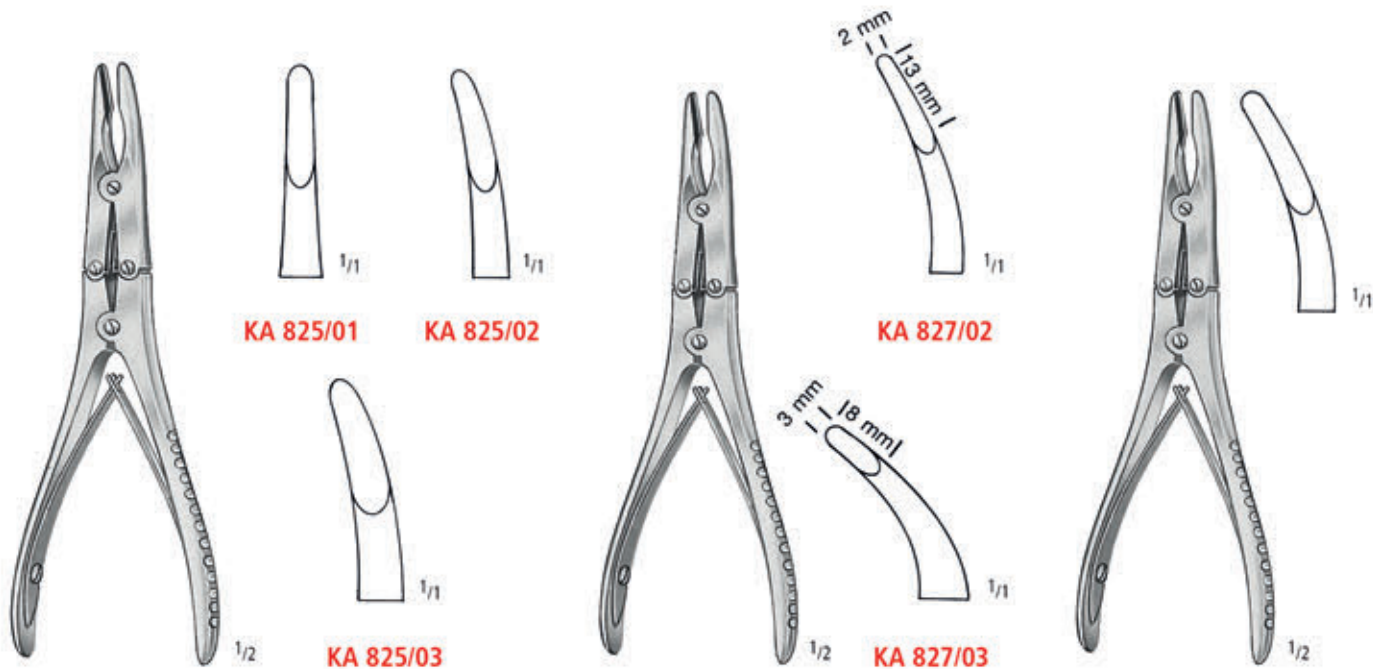

**BÖHLER**  
 15,0 cm/6"

**KLEINERT-KUTZ**  
 15,0 cm/6"

**RUSKIN-MINI**  
**KA 829/15**  
 15,0 cm/6"

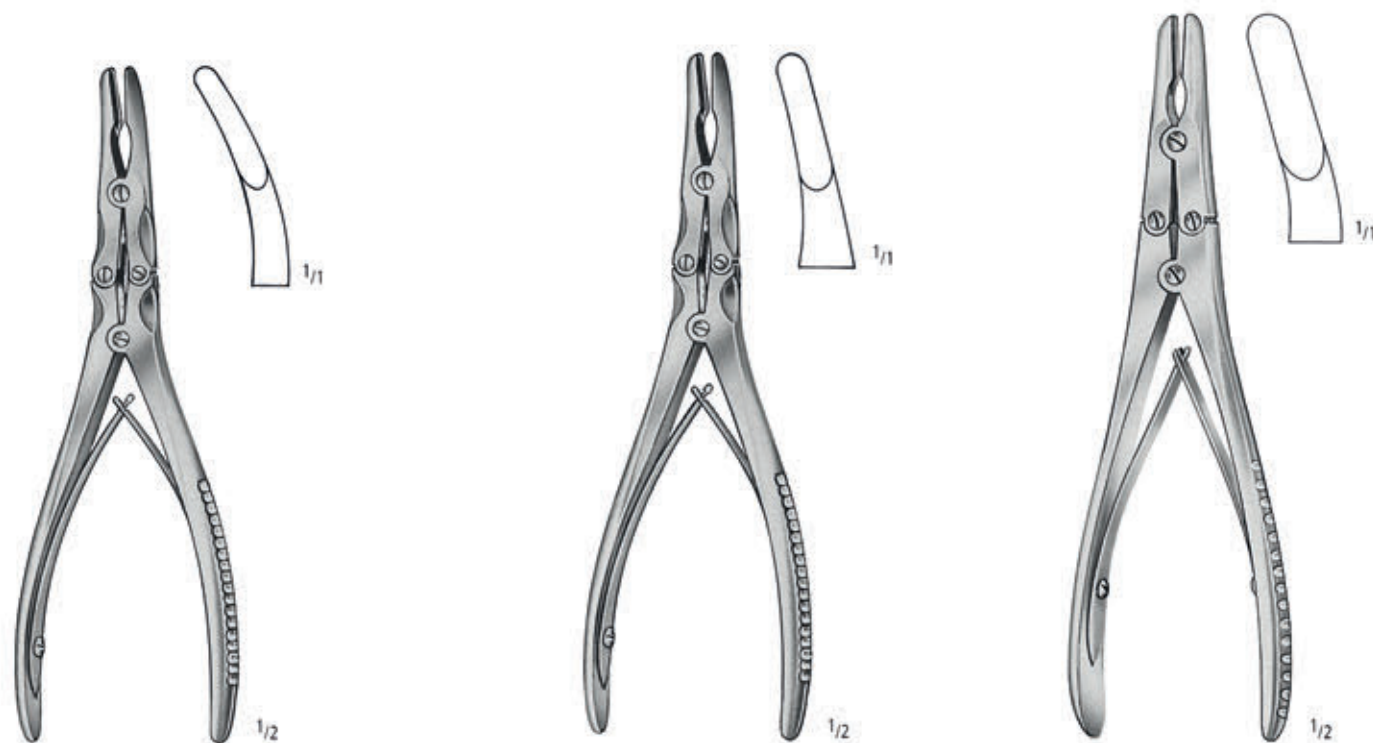

**BEYER**  
**KA 830/18**  
 18,0 cm/7"

**ZAUFAL-JANSEN**  
**KA 835/18**  
 18,0 cm/7"

**RUSKIN**  
**KA 836/18**  
 18,0 cm/7"

AA  
 AB  
 AC  
 AE  
 AK  
 AO  
 AR  
 KA  
 KS  
 XR  
 XT



Hohlmeisselzangen  
 Bone Rongeurs  
 Pinzas-gubias  
 Pincis-gouges  
 Pinze-sgorbie

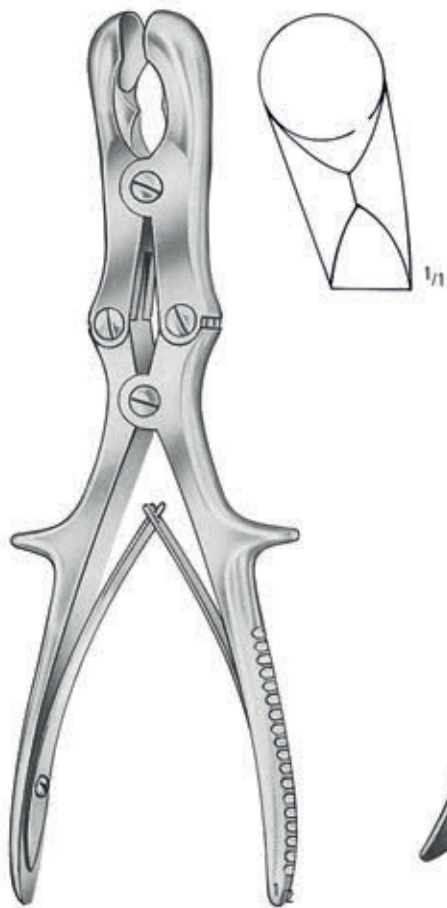

**SEMB**  
**KA 838/22**  
 22,5 cm/9"



**STILLE**  
**KA 840/23**  
 23,0 cm/9"



**STILLE-RUSKIN**  
**KA 841/23**  
 23,0 cm/9"

Hohlmeisselzangen  
 Bone Rongeurs  
 Pinzas-gubias  
 Pincis-gouges  
 Pinze-sgorbie

AA

AB

AC

AE

AK

AO

AR

KA

KS

XR

XT



**KA 848/01**  
8 mm

**KA 848/02**  
4 mm

**LEKSELL-STILLE**  
24,0 cm/9 1/2"



**FRYKHOLM**  
**KA 859/23**  
23,0 cm/9"



**KA 860/01**  
2 x 10 mm

**KA 860/02**  
3 x 10 mm

**KA 860/03**  
4 x 10 mm

**ECHLIN**  
23,0 cm/9"

Hohlmeisselzangen  
 Bone Rongeurs  
 Pinzas-gubias  
 Pincis-gouges  
 Pinze-sgorbie



**RUSKIN**  
**KA 862/23**  
 23,0 cm/9"



**SMITH-PETERSON**  
 24,0 cm/9½"



3,0 mm  
**KA 863/03**



4,0 mm  
**KA 863/04**



5,0 mm  
**KA 863/05**



3,0 mm  
**KA 863/13**

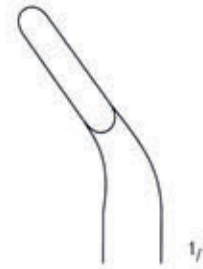

4,0 mm  
**KA 863/14**

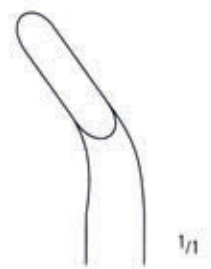

5,0 mm  
**KA 863/15**

AA

AB

AC

AE

AK

AO

AR

**KA**

KS

XR

XT





NEUROCHIRURGIE  
NEUROSURGERY  
NEUROCIRUGIA  
NEUROCHIRURGIE  
NEUROCHIRURGIA

**KS**

**nopa**<sup>®</sup> instruments





Feine Arterienklemmen  
 Fine Artery Forceps  
 Pinzas hemostáticas finas  
 Pincas hémostatiques fines  
 Pinze emostatiche fine

AA

AB

AC

AE

AK

AO

AR

KA

KS

XR

XT



**HOEN**  
**KS 001/13**  
 13,5 cm/5<sup>1</sup>/<sub>4</sub>"



**RAIMONDI**  
**KS 003/13**  
 12,5 cm/5"

Präparierklemmen  
 Dissecting Forceps  
 Pinzas para preparaciones  
 Pincers à dissection  
 Pinze per preparazione



**KS 011/01**  
 19,5 cm/8"



**KS 011/02**  
 19,5 cm/8"

Mikro-Instrumente  
 Micro Instruments  
 Instrumentos para microcirugía  
 Instruments pour la chirurgie micro  
 Strumenti per la chirurgia micro

AA

AB

AC

AE

AK

AO

AR

KA

**KS**

XR

XT



18,5 cm/7 1/4"



KS 014/01



KS 014/02



Mikro-Pinzetten  
 Micro Forceps  
 Micro-Pinzas  
 Micro-Pinces  
 Micro-Pinze



L	TIP	
18,0 cm/7"	0,6 mm	<b>KS 020/06</b>
18,0 cm/7"	0,9 mm	<b>KS 020/09</b>
18,0 cm/7"	1 : 2	<b>KS 020/20</b>
20,0 cm/8"	0,6 mm	<b>KS 022/06</b>
20,0 cm/8"	0,9 mm	<b>KS 022/09</b>
22,0 cm/8 <sup>3</sup> / <sub>4</sub> "	0,6 mm	<b>KS 024/06</b>
22,0 cm/8 <sup>3</sup> / <sub>4</sub> "	0,9 mm	<b>KS 024/09</b>
24,0 cm/9 <sup>1</sup> / <sub>2</sub> "	0,6 mm	<b>KS 026/06</b>
24,0 cm/9 <sup>1</sup> / <sub>2</sub> "	0,9 mm	<b>KS 026/09</b>

Mikro-Pinzetten, Nahtpinzetten  
 Micro Forceps, Suture Forceps  
 Micro-Pinzas, Pinzas para sutura  
 Micro-Pinces, Pinces pour sutures  
 Micro-Pinze, Pinze per sutura

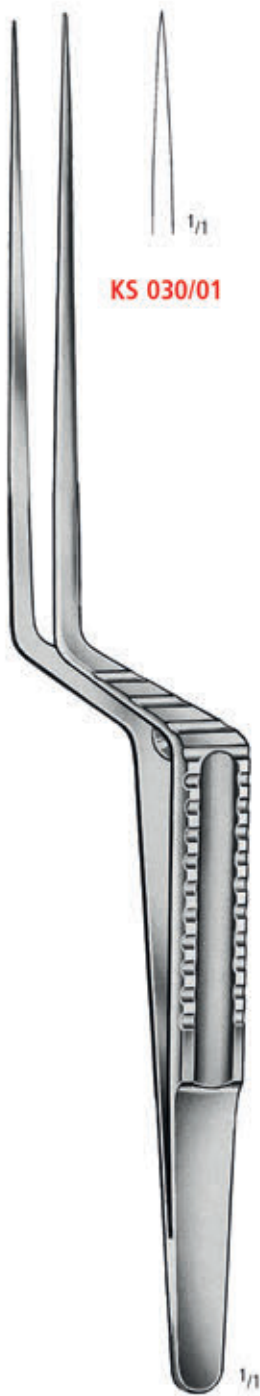

18,5 cm/7 1/4"

KS 030/01



1/1

KS 030/02



1/1

KS 030/03



1/1



KS 036/18  
 18,5 cm/7 1/4"



2/1

1/1

AA

AB

AC

AE

AK

AO

AR

KA

KS

XR

XT

Mikro-Pinzetten  
 Micro Forceps  
 Micro-Pinzas  
 Micro-Pinces  
 Micro-Pinze

## TITANIUM



**DIETRICH**

1,5 mm



2,0 mm



2,8 mm



15,0 cm/6"

**KS 040/15**

**KS 040/20**

**KS 040/28**

20,0 cm/8"

**KS 041/15**

**KS 041/20**

**KS 041/28**

24,0 cm/9<sup>3</sup>/<sub>4</sub>"

**KS 042/15**

**KS 042/20**

**KS 042/28**

Mikroscheren  
Micro Scissors  
Micro Tijeras  
Micro Ciseaux  
Micro Forbici



20,0 cm/8"

45°



**NAGEL**  
KS 050/20

45°



KS 051/20

125°



KS 052/20

AA

AB

AC

AE

AK

AO

AR

KA

**KS**

XR

XT

Mikroscheren  
Micro Scissors  
Micro Tijeras  
Micro Ciseaux  
Micro Forbici

gezahnt  
saw edge  
dentadas  
dentelés  
dentata



16,0 cm/6 1/4"

**KS 060/16**

gerade  
straight  
rectas  
droits  
retta

**KS 061/16**

gebogen  
curved  
curvas  
courbes  
curva



**VANNAS**

16,0 cm/6 1/4"

**KS 062/16**

gerade  
straight  
rectas  
droits  
retta

**KS 063/16**

gebogen  
curved  
curvas  
courbes  
curva



**MILLESİ**

16,0 cm/6 1/4"

**KS 064/16**

gerade  
straight  
rectas  
droits  
retta

**KS 065/16**

gebogen  
curved  
curvas  
courbes  
curva



Mikroscheren  
 Micro Scissors  
 Micro Tijeras  
 Micro Ciseaux  
 Micro Forbici

AA

AB

AC

AE

AK

AO

AR

KA

**KS**

XR

XT



**KS 068/00**  
 18,5 cm/7<sup>1</sup>/<sub>4</sub>"



**KS 069/19**  
 19,0 cm/7<sup>1</sup>/<sub>2</sub>"

Mikro-Nadelhalter mit Rundgriff  
 Micro-Needle Holders with pen-type handle  
 Micro-porta-agujas con mango redondo  
 Micro-porte-aiguilles à manches rondes  
 Micro-portaghi con manici rotondi



**BARRAQUER**



Tip 0,3 mm



Tip 0,8 mm

14,0 cm/5½"  
 18,0 cm/7"

**KS 070/14**  
**KS 070/18**

**KS 071/14**  
**KS 071/18**

Tip 0,8 mm

Tip 0,8 mm

14,0 cm/5½"  
 18,0 cm/7"

**KS 072/14**  
**KS 072/18**

**KS 073/14**  
**KS 073/18**



Tip 0,3 mm



Tip 0,3 mm

14,0 cm/5½"  
 18,0 cm/7"

**KS 074/14**  
**KS 074/18**

**KS 075/14**  
**KS 075/18**

Tip 0,8 mm

Tip 0,8 mm

14,0 cm/5½"  
 18,0 cm/7"

**KS 076/14**  
**KS 076/18**

**KS 077/14**  
**KS 077/18**



**BARRAQUER**

Nadelhalter  
Needle Holders  
Porta-agujas  
Porte-aiguilles  
Portaghi

nopa® DIAMOND



14,0 cm/5 1/2"



1/1

**KS 080/14**



1/1

18,0 cm/7"  
23,0 cm/9"

**KS 080/18**  
**KS 080/23**



14,0 cm/5 1/2"



1/1

**KS 081/14**



1/1

18,0 cm/7"  
23,0 cm/9"

**KS 081/18**  
**KS 081/23**

AA

AB

AC

AE

AK

AO

AR

KA

**KS**

XR

XT

Nadelhalter  
Needle Holders  
Porta-agujas  
Porte-aiguilles  
Portaghi

nopa<sup>®</sup> DIAMOND



21,0 cm/8 1/4"



KS 082/21



KS 083/21

Nadelhalter  
Needle Holders  
Porta-agujas  
Porte-aiguilles  
Portaghi

nopa® DIAMOND



15,0 cm/6"  
18,0 cm/7"  
23,0 cm/9"

**KS 084/15**  
**KS 084/18**  
**KS 084/23**

AA  
AB  
AC  
AE  
AK  
AO  
AR  
KA  
**KS**  
XR  
XT



Instrumente zur Schädelöffnung  
 Instruments for Cranial Opening  
 Instrumentos para abertura craneana  
 Instruments pour l'ouverture du crâne  
 Strumenti per l'apertura del cranio

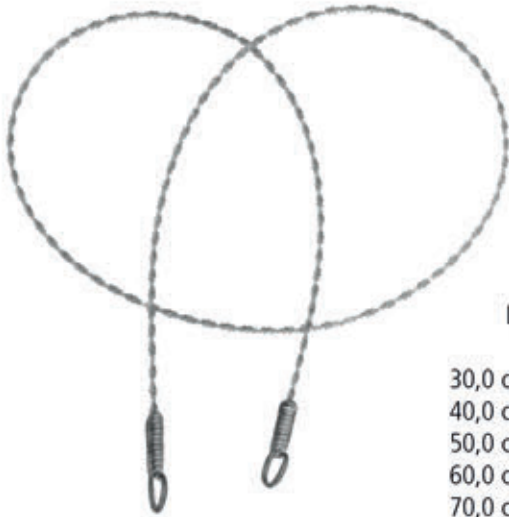

L	2x	3x
30,0 cm/12"	<b>KS 102/30</b>	<b>KS 103/30</b>
40,0 cm/16"	<b>KS 102/40</b>	<b>KS 103/40</b>
50,0 cm/20"	<b>KS 102/50</b>	<b>KS 103/50</b>
60,0 cm/24"	<b>KS 102/60</b>	<b>KS 103/60</b>
70,0 cm/28"	<b>KS 102/70</b>	<b>KS 103/70</b>

**OLIVECRONA-GIGLI**



**KS 120/00**  
 Paar / pair / pareja / paire / paio

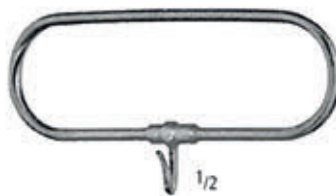

**KS 122/00**  
 Paar / pair / pareja / paire / paio



**MARTEL**  
**KS 130/33**  
 33,0 cm/13"

Instrumente zur Schädelöffnung  
 Instruments for Cranial Opening  
 Instrumentos para abertura craneana  
 Instruments pour l'ouverture du crâne  
 Strumenti per l'apertura del cranio

AA

AB

AC

AE

AK

AO

AR

KA

**KS**

XR

XT



**DE VILBISS**  
**KS 160/21**  
 21,0 cm/8<sup>1</sup>/<sub>4</sub>"



**DAHLGREEN**  
**KS 162/20**  
 20,0 cm/8"

Schädelhalter  
 Cervical Traction Tongs  
 Pinzas de tracción craneal  
 Pinces de traction crânienne  
 Pinze per trazione craniale



**CRUTCHFIELD**  
**KS 200/01**



**CRUTCHFIELD**  
**KS 200/02**



**KS 201/04**  
 Ø 3,5 mm



**KS 201/05**  
 Ø 5,0 mm



**KS 210/00**



**KS 210/01**

Ersatzdorn  
 Spare Pin  
 Punta de repuesto  
 Pointe de rechange  
 Punta da scorta

Himnretraktor  
Brain Retractor  
Separadores cerebrales  
Ecarteurs cérébrales  
Divaricatori cerebrali

AA

AB

AC

AE

AK

AO

AR

KA

KS

XR

XT

# LEYLA

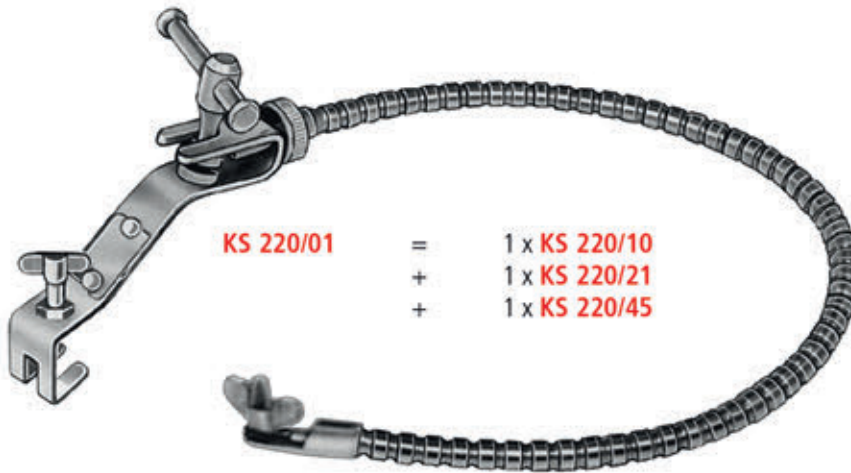

KS 220/01 = 1 x KS 220/10  
+ 1 x KS 220/21  
+ 1 x KS 220/45

LEYLA - 1  
KS 220/01

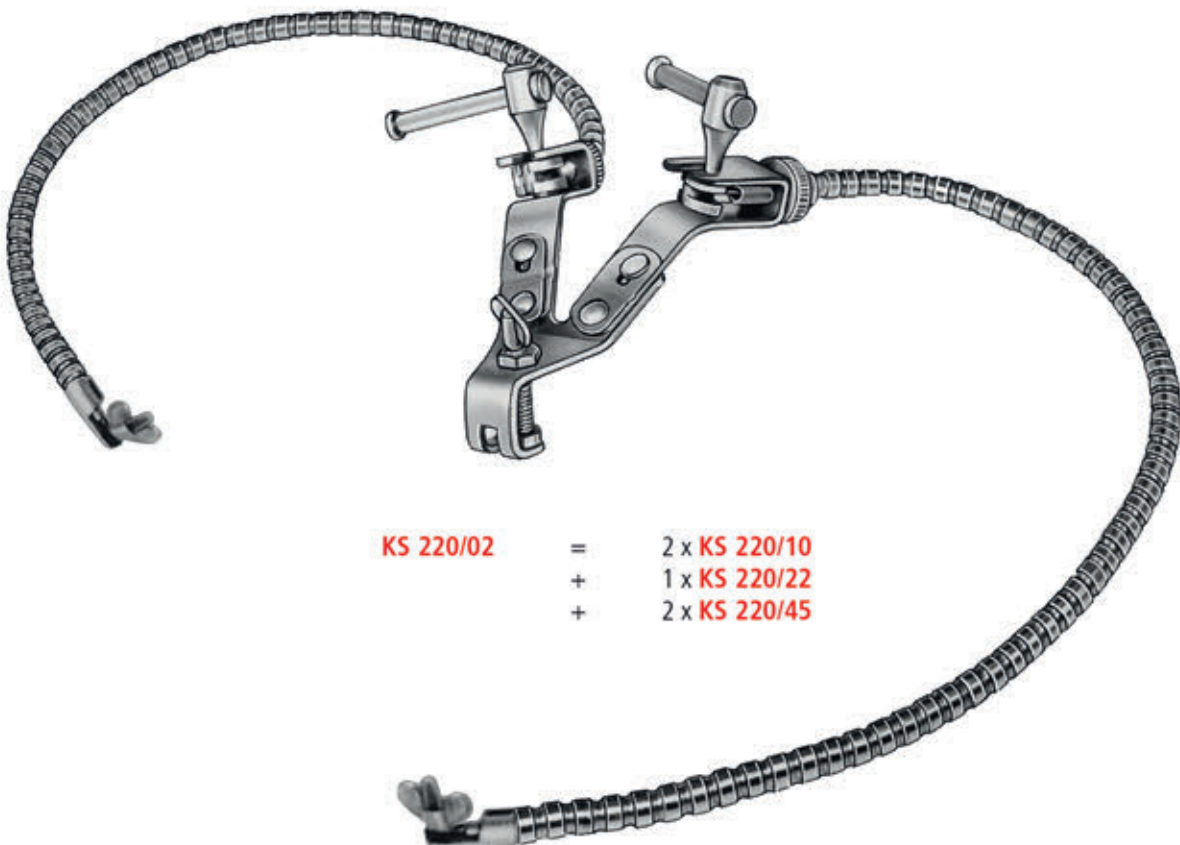

KS 220/02 = 2 x KS 220/10  
+ 1 x KS 220/22  
+ 2 x KS 220/45

LEYLA - 2  
KS 220/02

Hirnretractor  
Brain Retractor  
Separadores cerebrales  
Ecarteurs cérébrales  
Divaricatori cerebrali

# LEYLA



**KS 220/10**



**KS 220/21**



**KS 220/22**



**KS 220/30**



**KS 220/40**



**KS 220/45**



Himnretraktor  
Brain Retractor  
Separadores cerebrales  
Ecarteurs cérébrales  
Divaricatori cerebrali

# LEYLA

Satz  
Set

**KS 222/00**

=  
+  
+

1 x **KS 222/10**

1 x **KS 222/20**

1 x **KS 222/25**



9 x 32 mm  
10 x 25 mm

**KS 222/09**  
**KS 222/10**



**KS 222/20**



**KS 222/25**



**KS 222/40**

AA  
AB  
AC  
AE  
AK  
AO  
AR  
KA  
KS  
XR  
XT

Hirnspatel  
Brain Spatulas  
Espátulas cerebrales  
Spatules cérébrales  
Spatoli cerebrali



biegsam  
malleable  
maleables  
malléables  
malleabile

- |       |                  |
|-------|------------------|
| 8 mm  | <b>KS 230/08</b> |
| 11 mm | <b>KS 230/11</b> |
| 14 mm | <b>KS 230/14</b> |
| 17 mm | <b>KS 230/17</b> |
| 20 mm | <b>KS 230/20</b> |

**HEIFETZ**  
20,0 cm/8"

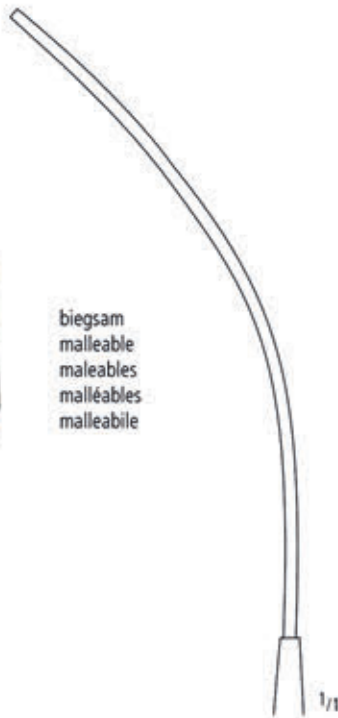

**OLIVECRONA**  
18,0 cm/7"

konkav  
concave  
cóncavas  
concaves  
concave

- |                  |    |    |                  |
|------------------|----|----|------------------|
| <b>KS 232/01</b> | 7  | 9  | <b>KS 233/01</b> |
| <b>KS 232/02</b> | 11 | 13 | <b>KS 233/02</b> |
| <b>KS 232/03</b> | 15 | 18 | <b>KS 233/03</b> |
| <b>KS 232/04</b> | 18 | 22 | <b>KS 233/04</b> |

A	B
mm	mm
7	9
11	13
15	18
18	22

konvex  
convex  
convexas  
convexes  
convesso



**HEIFETZ**  
18,0 cm/7"

biegsam  
malleable  
maleables  
malléables  
malleabile

- | A  | B  |                  |
|----|----|------------------|
| mm | mm |                  |
| 7  | 9  | <b>KS 236/01</b> |
| 11 | 13 | <b>KS 236/02</b> |
| 15 | 18 | <b>KS 236/03</b> |
| 18 | 22 | <b>KS 236/04</b> |

biegsam  
malleable  
maleables  
malléables  
malleabile



- |       |                  |
|-------|------------------|
| 12 mm | <b>KS 237/12</b> |
| 17 mm | <b>KS 237/17</b> |

**HEIFETZ**  
20,0 cm/8"

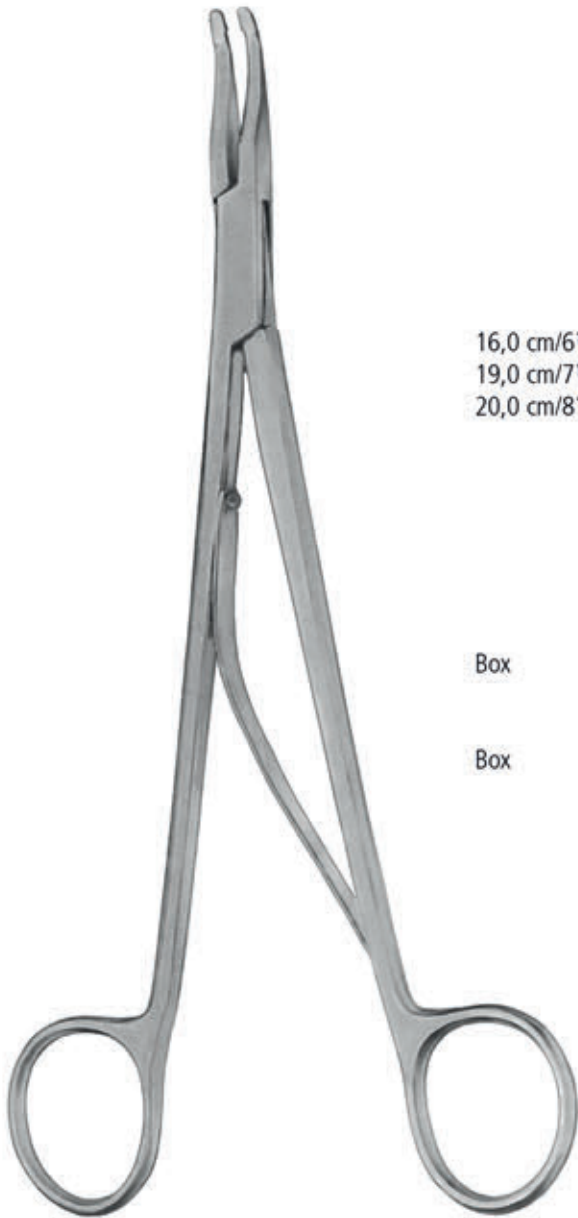

Anlegezangen, Clips  
 Applying Forceps, Clips  
 Pinzas aplicadoras, Clips  
 Pincas pour le cuir chevelu, Clips  
 Pinze al cuoio capelluto, Clips



	klein small	mittel medium	mittel-groß medium-large	groß large
	16,0 cm/6 <sup>1</sup> / <sub>4</sub> " 19,0 cm/7 <sup>1</sup> / <sub>2</sub> " 20,0 cm/8"			
	<b>KS 240/01</b>	<b>KS 240/02</b>	<b>KS 241/01</b>	<b>KS 242/03</b>
				
Box	12 x 25 clips <b>KS 244/01</b>	10 x 25 clips <b>KS 245/01</b>	16 x 10 clips <b>KS 246/01</b>	10 x 15 clips <b>KS 247/01</b>
Box	24 x 10 clips <b>KS 244/02</b>	20 x 10 clips <b>KS 245/02</b>		12 X 10 clips <b>KS 247/02</b>

AA  
AB  
AC  
AE  
AK  
AO  
AR  
KA  
KS  
XR  
XT

Anlegezangen  
 Applying Forceps  
 Pinzas aplicadoras  
 Pincès pour le cuir chevelu  
 Pinze al cuoio capelluto

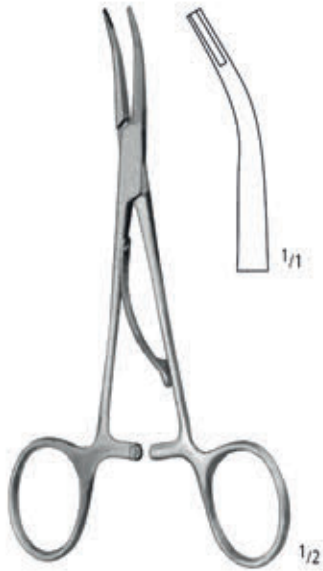

**MC KENZIE**

15,0 cm/6" **KS 250/15**  
 19,0 cm/7 1/2" **KS 250/19**

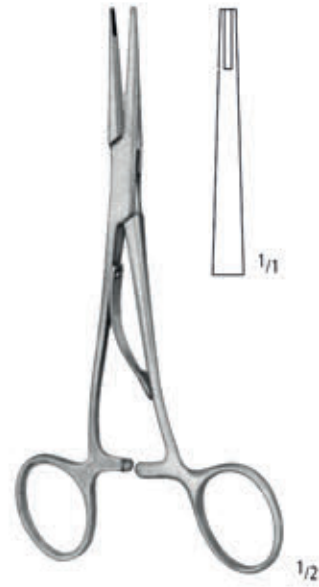

**MC KENZIE**

15,0 cm/6" **KS 255/15**  
 19,0 cm/7 1/2" **KS 255/19**

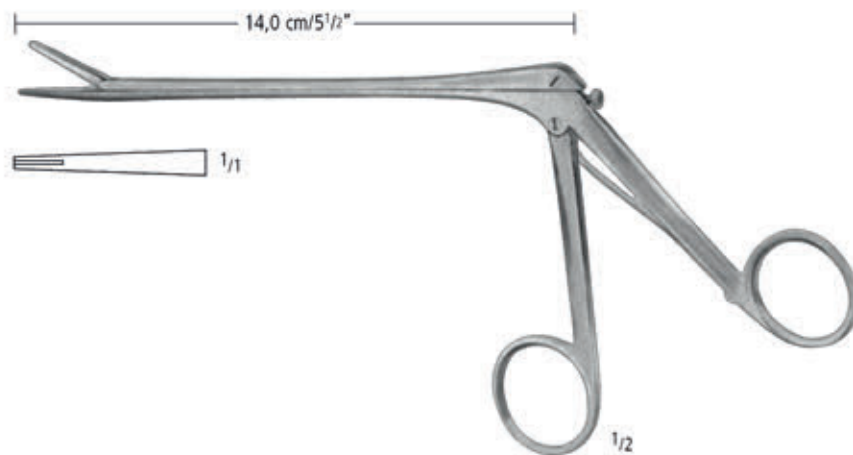

**OLIVECRONA-TOENNIS  
 (SCOVILLE)  
 KS 258/00**

Klammern und Anlegezangen  
 Clips and Applying Forceps  
 Grapas y pinzas aplicadoras  
 Clips et pinces pour le cuir chevelu  
 Agrafes e pinze al cuoio capelluto

AA

AB

AC

AE

AK

AO

AR

KA

KS

XR

XT



**MC KENZIE**  
 148 x 40 x 6 mm  
**KS 275/01**



**MC KENZIE**  
 190 x 48 x 13 mm  
**KS 275/02**

Verkaufseinheit: 100 Stück  
 Unit for Sale: 100 pieces  
 Unidad de venta: 100 piezas  
 Unité de vente: 100 pièces  
 Unità di vendita: 100 pezzi



**KS 277/00**



**RANEY**  
**KS 286/00**  
 16,0 cm/6<sup>1</sup>/<sub>4</sub>"



**RANEY**  
**KS 288/00**



Galeahaken  
 Galea Hooks  
 Gancho para Galea  
 Crochets à Galea  
 Uncini per Galea

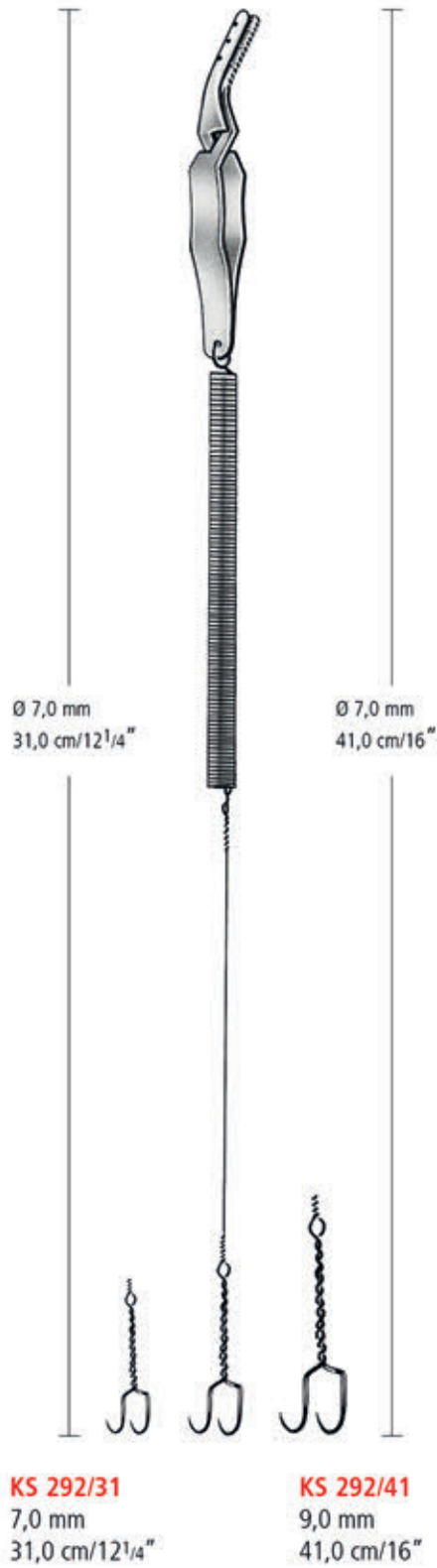

Aneurysmen- und Gefäßclips  
 Aneurysm- and Vessel Clips  
 Clips de Aneurisma  
 Clips pour Aneurisme  
 Clips per Aneurismi

Also available in  
**TITANIUM**

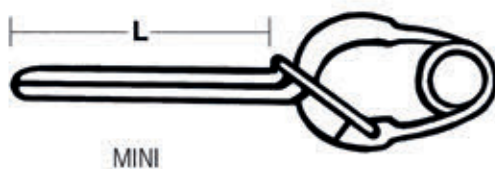

**B**  
 Maulöffnung  
 Opening  
 Abertura  
 Overture  
 Apertura

**F**  
 Schließkraft  
 Closing Force  
 Presión  
 Pression  
 Pressione

Permanent	<b>KS 300/01</b>	<b>KS 302/01</b>	<b>KS 304/01</b>	<b>KS 306/01</b>	<b>KS 308/01</b>
Temporary	<b>KS 300/02</b>	<b>KS 302/02</b>			<b>KS 308/02</b>

Permanent	<b>KS 301/01</b>	<b>KS 303/01</b>	<b>KS 305/01</b>	<b>KS 307/01</b>	<b>KS 309/01</b>
Temporary		<b>KS 303/02</b>		<b>KS 307/02</b>	

Permanent	<b>KS 311/01</b>	<b>KS 313/01</b>	<b>KS 315/01</b>	<b>KS 317/01</b>	<b>KS 319/01</b>
Temporary		<b>KS 313/02</b>			

	L (mm)	B (mm)	F (g)
<b>KS 300/01</b>	3,0	3,3	110
<b>KS 300/02</b>	3,0	3,3	50
<b>KS 301/01</b>	3,0	3,2	110
<b>KS 302/01</b>	5,0	4,0	110
<b>KS 302/02</b>	5,0	4,0	50
<b>KS 303/01</b>	5,0	3,8	110
<b>KS 303/02</b>	5,0	3,8	50
<b>KS 304/01</b>	3,0	3,3	110
<b>KS 305/01</b>	5,0	3,8	110
<b>KS 306/01</b>	5,0	4,0	110
<b>KS 307/01</b>	7,0	4,4	110

Also available in  
**TITANIUM**

<b>KS 307/02</b>	7,0	4,4	70
<b>KS 308/01</b>	7,0	4,6	110
<b>KS 308/02</b>	7,0	4,6	70
<b>KS 309/01</b>	5,0	3,6	110
<b>KS 311/01</b>	5,0	3,5	110
<b>KS 313/01</b>	7,0	4,0	110
<b>KS 313/02</b>	7,0	4,0	70
<b>KS 315/01</b>	5,0	3,5	130
<b>KS 317/01</b>	7,0	5,7	130
<b>KS 319/01</b>	7,0	4,5	130

Aneurysmen- und Gefäßclipse  
 Aneurysm- and Vessel Clips  
 Clips de Aneurisma  
 Clips pour Aneurisme  
 Clips per Aneurismi

Also available in  
**TITANIUM**

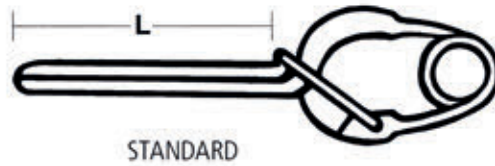

**B**  
 Maulöffnung  
 Opening  
 Abertura  
 Overture  
 Apertura

**F**  
 Schließkraft  
 Closing Force  
 Presión  
 Pression  
 Pressione



Permanent  
 Temporary

**KS 330/01**   **KS 332/01**   **KS 334/01**   **KS 331/01**   **KS 333/01**   **KS 335/01**  
**KS 332/02**   **KS 333/02**



Permanent  
 Temporary

**KS 337/01**   **KS 339/01**   **KS 341/01**   **KS 342/01**   **KS 344/01**   **KS 346/01**   **KS 347/01**   **KS 349/01**  
**KS 339/02**   **KS 342/02**   **KS 344/02**   **KS 347/02**   **KS 349/02**

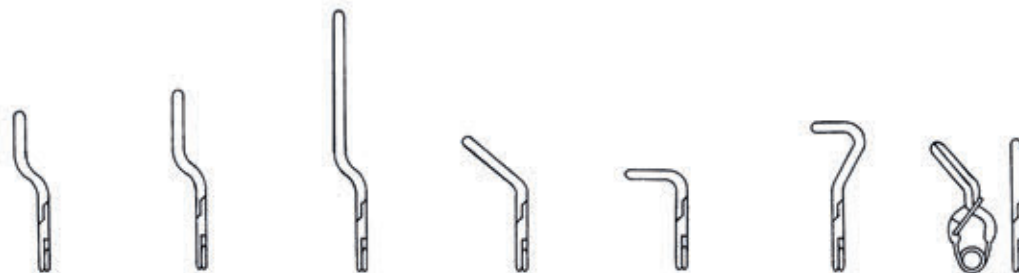

Permanent

**KS 351/01**   **KS 353/01**   **KS 355/01**   **KS 357/01**   **KS 359/01**   **KS 361/01**   **KS 363/01**

	L (mm)	B (mm)	F (g)
<b>KS 330/01</b>	7,0	6,2	150
<b>KS 331/01</b>	7,0	6,0	150
<b>KS 332/01</b>	9,0	7,0	180
<b>KS 332/02</b>	9,0	7,0	70
<b>KS 333/01</b>	9,0	6,8	180
<b>KS 333/02</b>	9,0	6,8	70
<b>KS 334/01</b>	11,0	7,8	180
<b>KS 335/01</b>	11,0	7,5	180
<b>KS 337/01</b>	7,0	5,5	150
<b>KS 339/01</b>	9,0	6,1	180
<b>KS 339/02</b>	9,0	6,1	70
<b>KS 341/01</b>	11,0	6,5	180
<b>KS 342/01</b>	15,0	9,2	200
<b>KS 342/02</b>	15,0	9,2	70

Also available in  
**TITANIUM**

	L (mm)	B (mm)	F (g)
<b>KS 344/01</b>	20,0	11,4	200
<b>KS 344/02</b>	20,0	11,4	90
<b>KS 346/01</b>	25,0	13,3	180
<b>KS 347/01</b>	15,0	8,7	200
<b>KS 347/02</b>	15,0	8,7	70
<b>KS 349/01</b>	15,0	7,4	200
<b>KS 349/02</b>	15,0	7,4	70
<b>KS 351/01</b>	7,0	7,9	200
<b>KS 353/01</b>	9,0	8,7	200
<b>KS 355/01</b>	20,0	13,0	180
<b>KS 357/01</b>	9,0	6,5	200
<b>KS 359/01</b>	7,0	4,5	200
<b>KS 361/01</b>	7,0	7,2	200
<b>KS 363/01</b>	7,0	5,7	200

Aneurysmen- und Gefäßclips  
 Aneurysm- and Vessel Clips  
 Clips de Aneurisma  
 Clips pour Aneurisme  
 Clips per Aneurismi

Also available in  
**TITANIUM**

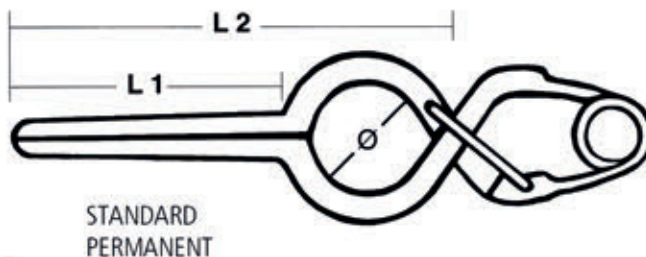

B Maulöffnung  
 Opening  
 Abertura  
 Overture  
 Apertura

F Schließkraft  
 Closing Force  
 Presión  
 Pression  
 Pressione

Ø 3,5 mm



**KS 370/01** **KS 370/02** **KS 370/03** **KS 371/01** **KS 371/02** **KS 371/03** **KS 372/01** **KS 372/02** **KS 372/03**

Ø 5,0 mm



**KS 374/01** **KS 374/02** **KS 374/03** **KS 375/01** **KS 375/02** **KS 375/03**

Also available in  
**TITANIUM**

Ø 5,0 mm

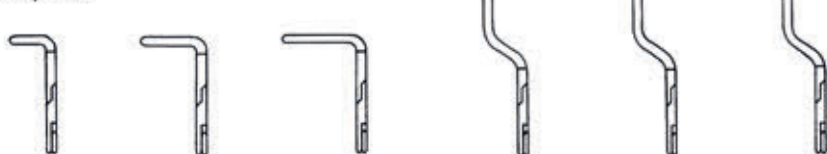

**KS 376/01** **KS 376/02** **KS 376/03** **KS 377/01** **KS 377/02** **KS 377/03**

	L1/L2 (mm)	B (mm)	F (g)		L1/L2 (mm)	B (mm)	F (g)
<b>KS 370/01</b>	6,0/11,0	7,4	150	<b>KS 375/01</b>	5,0/10,5	6,5	150
<b>KS 370/02</b>	9,0/14,0	8,4	150	<b>KS 375/02</b>	7,5/13,0	7,2	150
<b>KS 370/03</b>	12,0/17,0	9,6	180	<b>KS 375/03</b>	10,0/15,5	7,8	180
<b>KS 371/01</b>	5,0/ 9,0	5,8	150	<b>KS 376/01</b>	5,0/11,0	5,5	150
<b>KS 371/02</b>	7,5/11,5	6,5	150	<b>KS 376/02</b>	7,5/13,5	5,5	150
<b>KS 371/03</b>	10,0/14,0	7,2	180	<b>KS 376/03</b>	10,0/16,0	5,5	180
<b>KS 372/01</b>	5,0/ 9,6	4,9	150	<b>KS 377/01</b>	5,0/14,8	7,9	150
<b>KS 372/02</b>	7,5/12,1	4,9	150	<b>KS 377/02</b>	7,5/17,3	8,8	150
<b>KS 372/03</b>	10,0/14,6	4,9	180	<b>KS 377/03</b>	10,0/19,8	10,0	180
<b>KS 374/01</b>	6,0/12,7	7,9	150				
<b>KS 374/02</b>	9,0/15,7	9,1	150				
<b>KS 374/03</b>	12,0/18,7	10,3	180				

Also available in  
**TITANIUM**

AA  
 AB  
 AC  
 AE  
 AK  
 AO  
 AR  
 KA  
 KS  
 XR  
 XT



Anlegezangen für Aneurysmen-Clips  
 Applying Forceps for Aneurysm Clips  
 Pinza para juntar clips de Aneurisma  
 Pince pour poser les clips de Aneurisme  
 Pinze per applicare clips Aneurismi



18,0 cm/7"

MINI  
STANDARD

**KS 390/01**  
**KS 390/02**



17,0 cm/6<sup>3</sup>/<sub>4</sub>"

**KS 391/01**  
**KS 391/02**



20,5 cm/8"

**KS 392/01**  
**KS 392/02**



22,5 cm/9"

**KS 393/01**  
**KS 393/02**



Anlegezangen für Aneurysmen-Clips  
 Applying Forceps for Aneurysm Clips  
 Pinza para juntar clips de Aneurisma  
 Pince pour poser les clips de Aneurisme  
 Pinze per applicare clips Aneurismi

AA  
AB  
AC  
AE  
AK  
AO  
AR  
KA  
KS  
XR  
XT

# FLEXIBLE

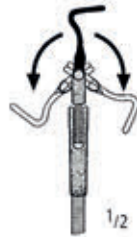

Beispiel für Drehmechanismus  
 Example for rotation  
 Ejemplo para la rotación  
 Exemple pour la rotation  
 Esempio per la rotazione

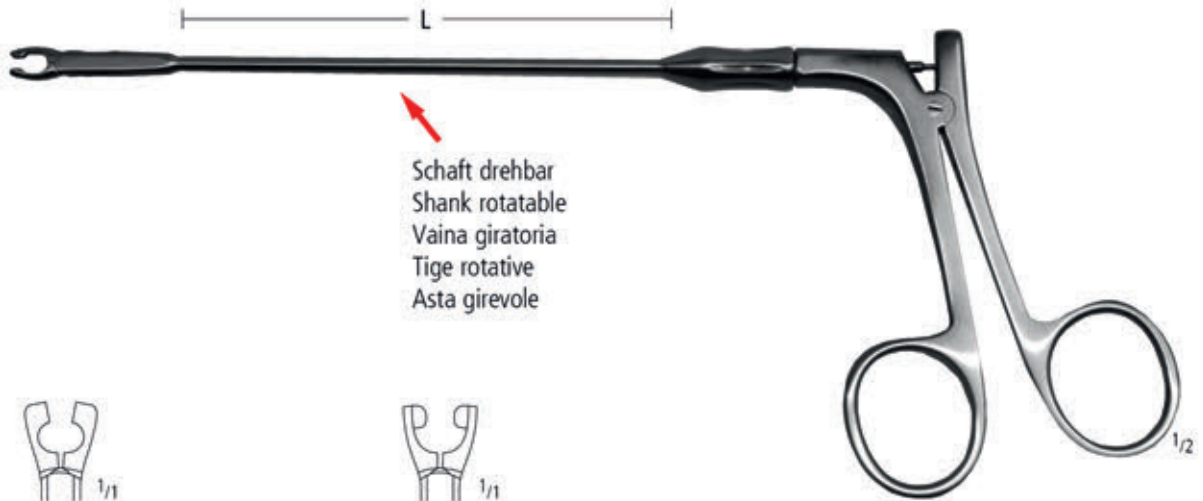

Schaft drehbar  
 Shank rotatable  
 Vaina giratoria  
 Tige rotative  
 Asta girevole



	MINI	STANDARD	MINI	STANDARD
70mm/2 <sup>3</sup> / <sub>4</sub> "	KS 396/11	KS 396/21	KS 397/11	KS 397/21
90mm/3 <sup>1</sup> / <sub>2</sub> "	KS 396/12	KS 396/22	KS 397/12	KS 397/22
110mm/4 <sup>1</sup> / <sub>4</sub> "	KS 396/13	KS 396/23	KS 397/13	KS 397/23
130mm/5"	KS 396/14	KS 396/24	KS 397/14	KS 397/24

nicht drehbar  
 non rotating  
 non rotatif  
 non rotativo  
 non rotatorio

drehbar  
 rotating  
 rotatif  
 rotativo  
 rotatorio

Muskelspreizer  
 Dissectomy Retractors  
 Separadores para músculos  
 Ecarteurs musculaire  
 Divaricatori muscolari



**KS 520/01**



1/1

20 x 50 mm

20 x 60 mm

20 x 70 mm

△ **KS 520/50**

**KS 520/60**

**KS 520/70**

∩ **KS 520/51**

**KS 520/61**

**KS 520/71**

- HEY**  
**KS 520/00** = 1 x **KS 520/01**  
 + 1 x **KS 520/50**  
 + 1 x **KS 520/60**  
 + 1 x **KS 520/70**  
 + 1 x **KS 520/37**  
 + 1 x **KS 520/53**  
 + 1 x **KS 520/62**



1/1

**KS 520/37**  
 37 mm

**KS 520/53**  
 53 mm

**KS 520/62**  
 62 mm

Muskelspreizer  
 Dissectomy Retractors  
 Separadores para músculos  
 Ecarteurs musculaire  
 Divaricatori muscolari



**KS 521/51 - KS 521/72**  
 17,0 cm/6<sup>3</sup>/<sub>4</sub>"



**KS 522/51 - KS 522/72**  
 17,0 cm/6<sup>3</sup>/<sub>4</sub>"

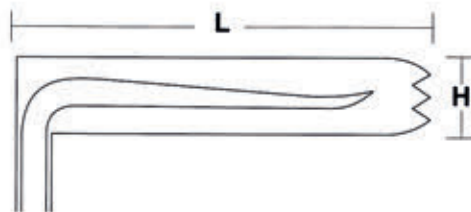

L	H	Linksmodell Left-type	Rechtsmodell Right-type
50 mm x 10 mm		<b>KS 521/51</b>	<b>KS 522/51</b>
60 mm x 10 mm		<b>KS 521/61</b>	<b>KS 522/61</b>
70 mm x 10 mm		<b>KS 521/71</b>	<b>KS 522/71</b>
50 mm x 20 mm		<b>KS 521/52</b>	<b>KS 522/52</b>
60 mm x 20 mm		<b>KS 521/62</b>	<b>KS 522/62</b>
70 mm x 20 mm		<b>KS 521/72</b>	<b>KS 522/72</b>

AA  
 AB  
 AC  
 AE  
 AK  
 AO  
 AR  
 KA  
 KS  
 XR  
 XT

Wundspreizer Wirbelsäule  
 Cervical Retractors  
 Separadores vertebrales  
 Ecarteurs cervicaux  
 Divaricatori vertebrali

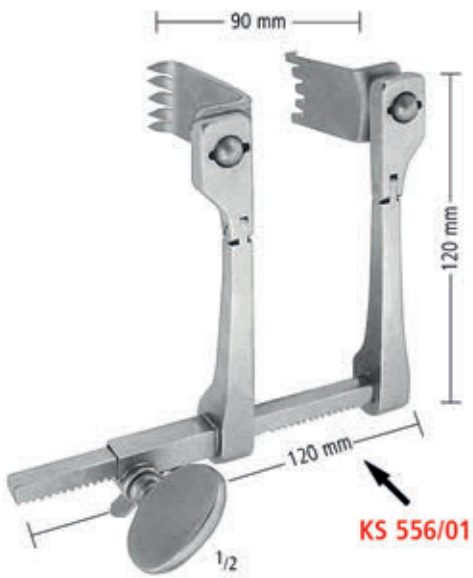

**CASPAR**  
**KS 556/00**  
 Transversal

- KS 556/00 = 1 x KS 556/01
- + 1 x KS 559/01
- + 1 x KS 559/02
- + 1 x KS 559/03
- + 1 x KS 559/04
- + 1 x KS 559/05
- + 1 x KS 559/11
- + 1 x KS 559/12
- + 1 x KS 559/13
- + 1 x KS 559/14
- + 1 x KS 559/15



**CASPAR**  
**KS 557/00**

- KS 557/00 = 1 x KS 557/01
- + 1 x KS 559/21
- + 1 x KS 559/22
- + 1 x KS 559/23
- + 1 x KS 559/24
- + 1 x KS 559/25

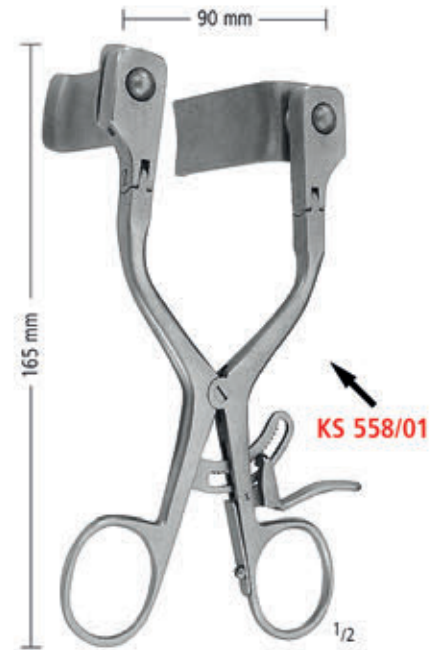

**CASPAR**  
**KS 558/00**

- KS 558/00 = 1 x KS 558/01
- + 1 x KS 559/21
- + 1 x KS 559/22
- + 1 x KS 559/23
- + 1 x KS 559/24
- + 1 x KS 559/25

Wundspreizer Wirbelsäule  
 Cervical Retractors  
 Separadores vertebrales  
 Ecarteurs cervicales  
 Divaricatori vertebrali



40 x 23 mm **KS 559/01**  
 45 x 23 mm **KS 559/02**  
 50 x 23 mm **KS 559/03**  
 55 x 23 mm **KS 559/04**  
 60 x 23 mm **KS 559/05**



40 x 23 mm **KS 559/11**  
 45 x 23 mm **KS 559/12**  
 50 x 23 mm **KS 559/13**  
 55 x 23 mm **KS 559/14**  
 60 x 23 mm **KS 559/15**



45 x 23 mm **KS 559/21**  
 50 x 23 mm **KS 559/22**  
 55 x 23 mm **KS 559/23**  
 60 x 23 mm **KS 559/24**  
 65 x 23 mm **KS 559/25**



50 x 25 mm **KS 559/50**  
 60 x 25 mm **KS 559/60**



**KS 564/00**  
 11,5 cm/4 1/2"

AA  
 AB  
 AC  
 AE  
 AK  
 AO  
 AR  
 KA  
 KS  
 XR  
 XT



Wundspreizer Wirbelsäule  
 Cervical Retractors  
 Separadores vertebrales  
 Ecarteurs cervicaux  
 Divaricatori vertebrali

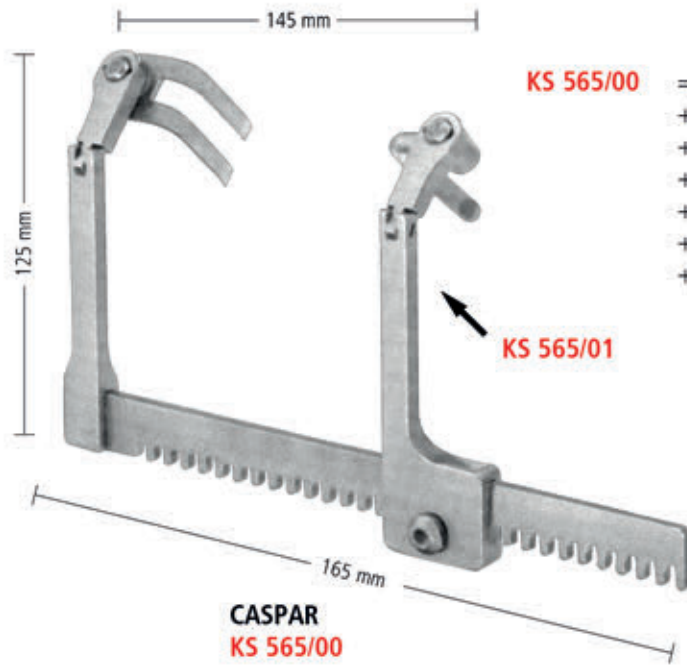

- KS 565/00** = 1 x **KS 565/01**  
 + 1 x **KS 565/99**  
 + 1 x **KS 566/21**  
 + 1 x **KS 566/22**  
 + 1 x **KS 566/23**  
 + 1 x **KS 566/24**  
 + 1 x **KS 566/25**



**KS 565/99**



38 mm  
**KS 566/01**



58 mm  
**KS 566/02**

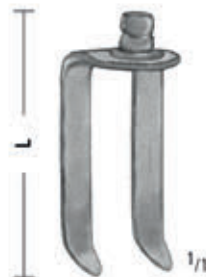

22 mm

- L**  
 32 mm **KS 566/20**  
 37 mm **KS 566/21**  
 43 mm **KS 566/22**  
 47 mm **KS 566/23**  
 52 mm **KS 566/24**  
 57 mm **KS 566/25**  
 62 mm **KS 566/26**  
 67 mm **KS 566/27**



37 mm

- KS 566/30**  
**KS 566/31**  
**KS 566/32**  
**KS 566/33**  
**KS 566/34**  
**KS 566/35**  
**KS 566/36**  
**KS 566/37**



52 mm

- KS 566/40**  
**KS 566/41**  
**KS 566/42**  
**KS 566/43**  
**KS 566/44**  
**KS 566/45**  
**KS 566/46**  
**KS 566/47**

Wundspreizer  
Retractors  
Separadores  
Ecarteurs  
Divaricatori

AA

AB

AC

AE

AK

AO

AR

KA

KS

XR

XT

Oberfläche geschwärzt  
Surface black-finish



CASPAR

L	
40 mm	<b>KS 568/40</b>
45 mm	<b>KS 568/45</b>
50 mm	<b>KS 568/50</b>
55 mm	<b>KS 568/55</b>
60 mm	<b>KS 568/60</b>



CASPAR



L	
35 mm	<b>KS 569/35</b>
40 mm	<b>KS 569/40</b>
45 mm	<b>KS 569/45</b>
50 mm	<b>KS 569/50</b>
55 mm	<b>KS 569/55</b>
60 mm	<b>KS 569/60</b>

<b>KS 569/00</b>	=	1 x <b>KS 569/01</b>
	+	1 x <b>KS 569/35</b>
	+	1 x <b>KS 569/40</b>
	+	1 x <b>KS 569/45</b>
	+	1 x <b>KS 569/50</b>
	+	1 x <b>KS 569/55</b>
	+	1 x <b>KS 569/60</b>

Wundspreizer  
Retractors  
Separadores  
Ecarteurs  
Divaricatori

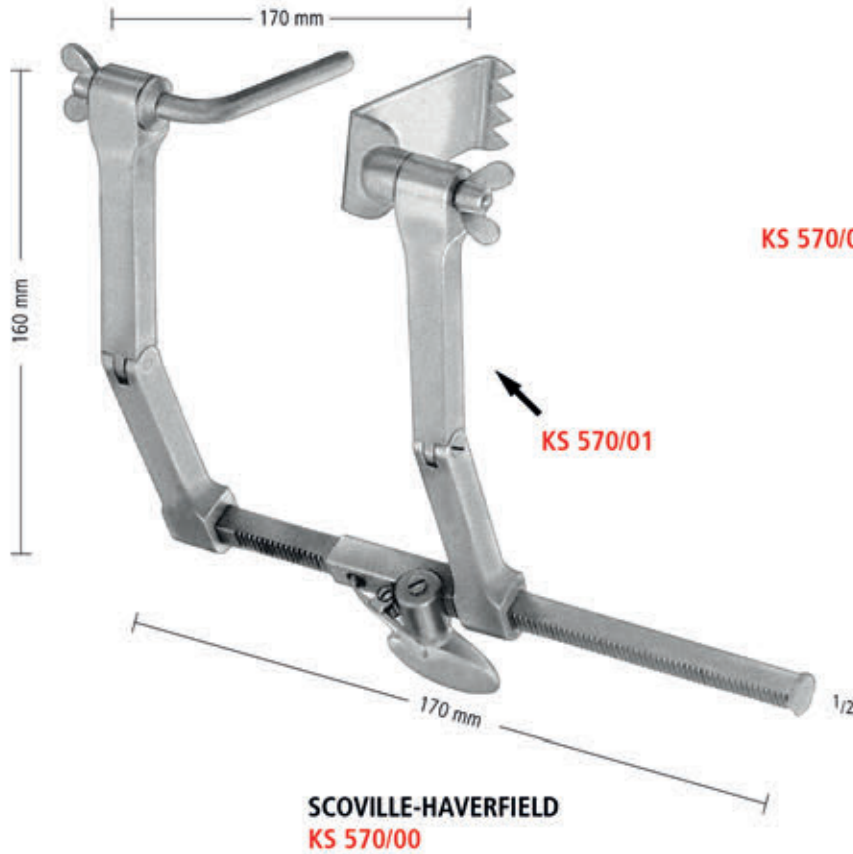

**KS 570/00** = 1 x **KS 570/01**  
+ 1 x **KS 570/02**  
+ 1 x **KS 570/10**



**SCOVILLE**  
**KS 570/02**  
5,5 cm/2"



**SCOVILLE**  
63 x 25 mm **KS 570/10**  
63 x 51 mm **KS 570/11**  
67 x 32 mm **KS 570/12**  
89 x 25 mm **KS 570/13**



**TAYLOR**  
47 X 37 mm **KS 570/33**



**TAYLOR**  
63 X 51 mm **KS 570/44**

Wundspreizer  
Retractors  
Separadores  
Ecarteurs  
Divaricatori

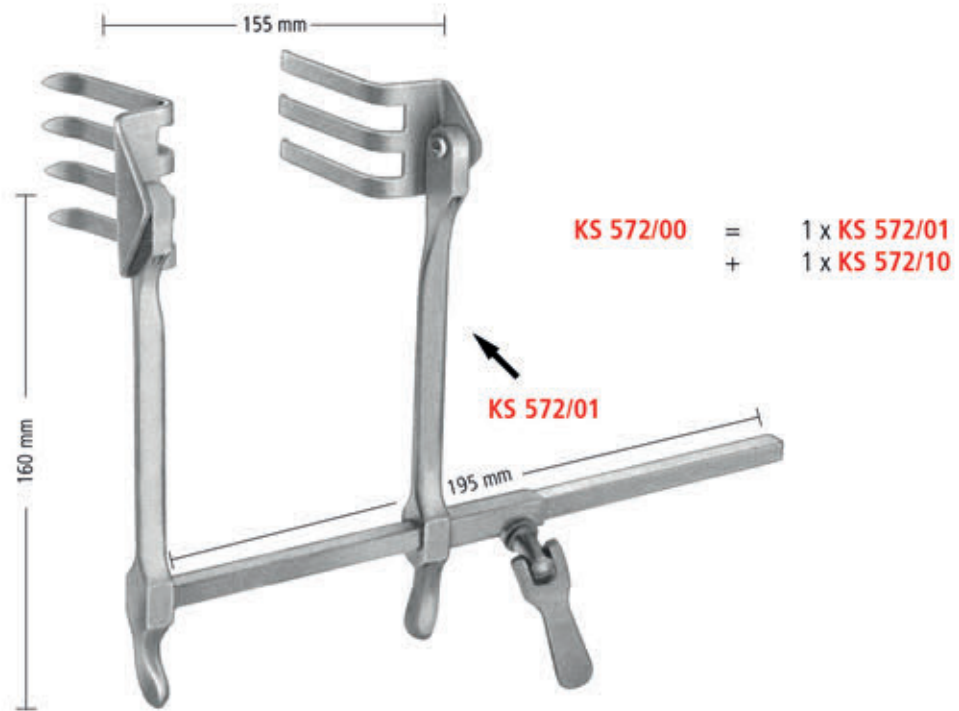

**SCOVILLE-RICHTER**  
**KS 572/00**



**KS 572/10 (Paar/Pair)**  
62 x 52 mm      62 x 37 mm



**KS 572/20**  
47 x 51 mm



**KS 572/30**  
30 x 40 mm



**KS 572/40**  
37 x 62 mm

AA  
AB  
AC  
AE  
AK  
AO  
AR  
KA  
KS  
XR  
XT

Wundspreizer  
Retractors  
Separadores  
Ecarteurs  
Divaricatori

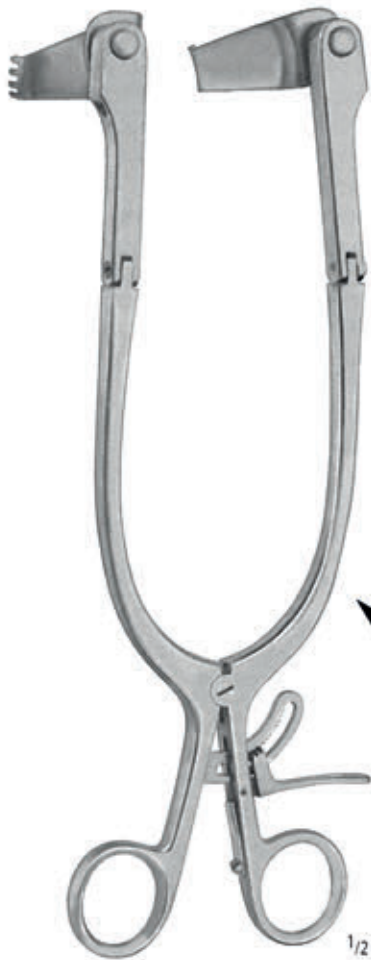

**CLOWARD modif.**  
**KS 580/00**  
25,0 cm/10"



- |          |                  |
|----------|------------------|
| <b>L</b> |                  |
| 40 mm    | <b>KS 580/10</b> |
| 45 mm    | <b>KS 580/11</b> |
| 50 mm    | <b>KS 580/12</b> |
| 55 mm    | <b>KS 580/13</b> |
| 60 mm    | <b>KS 580/14</b> |



- |          |                  |
|----------|------------------|
| <b>L</b> |                  |
| 40 mm    | <b>KS 580/20</b> |
| 45 mm    | <b>KS 580/21</b> |
| 50 mm    | <b>KS 580/22</b> |
| 55 mm    | <b>KS 580/23</b> |
| 60 mm    | <b>KS 580/24</b> |

- |                  |   |                      |
|------------------|---|----------------------|
| <b>KS 580/00</b> | = | 1 x <b>KS 580/01</b> |
|                  | + | 1 x <b>KS 580/10</b> |
|                  | + | 1 x <b>KS 580/11</b> |
|                  | + | 1 x <b>KS 580/12</b> |
|                  | + | 1 x <b>KS 580/13</b> |
|                  | + | 1 x <b>KS 580/14</b> |



Wundspreizer  
Retractors  
Separadores  
Ecarteurs  
Divaricatori

AA

AB

AC

AE

AK

AO

AR

KA

KS

XR

XT



KS 582/00



- |       |           |
|-------|-----------|
| L     |           |
| 40 mm | KS 580/10 |
| 45 mm | KS 580/11 |
| 50 mm | KS 580/12 |
| 55 mm | KS 580/13 |
| 60 mm | KS 580/14 |



- |       |           |
|-------|-----------|
| L     |           |
| 40 mm | KS 580/20 |
| 45 mm | KS 580/21 |
| 50 mm | KS 580/22 |
| 55 mm | KS 580/23 |
| 60 mm | KS 580/24 |

- |           |   |               |
|-----------|---|---------------|
| KS 582/00 | = | 1 x KS 582/01 |
|           | + | 1 x KS 580/10 |
|           | + | 1 x KS 580/11 |
|           | + | 1 x KS 580/12 |
|           | + | 1 x KS 580/13 |
|           | + | 1 x KS 580/14 |

Wirbelkörperspreizer  
 Lamina Spreaders  
 Separadores para cuerpos vertebrales  
 Ecarteurs pour corps vertébraux  
 Separatori per vertebre



**CLOWARD**  
**KS 587/08**  
 T = 70 mm



**CLOWARD**  
**KS 588/09**      **KS 588/11**  
 9,0 cm/3<sup>3</sup>/<sub>4</sub>"      11,0 cm/4<sup>1</sup>/<sub>4</sub>"

Wirbelkörperspreizer  
 Lamina Spreaders  
 Separadores para cuerpos vertebrales  
 Ecarteurs pour corps vertébraux  
 Separatori per vertebre

AA  
 AB  
 AC  
 AE  
 AK  
 AO  
 AR  
 KA  
 KS  
 XR  
 XT



**HARMS**  
**KS 590/01**  
 18,0 cm/7"



**HARMS**  
**KS 590/02**  
 18,0 cm/7"

Wirbelkörperspreizer  
 Lamina Spreaders  
 Separadores para cuerpos vertebrales  
 Ecarteurs pour corps vertébraux  
 Separatori per vertebre



**CLOWARD**  
**KS 592/16**  
 16,0 cm/6<sup>1</sup>/<sub>2</sub>"

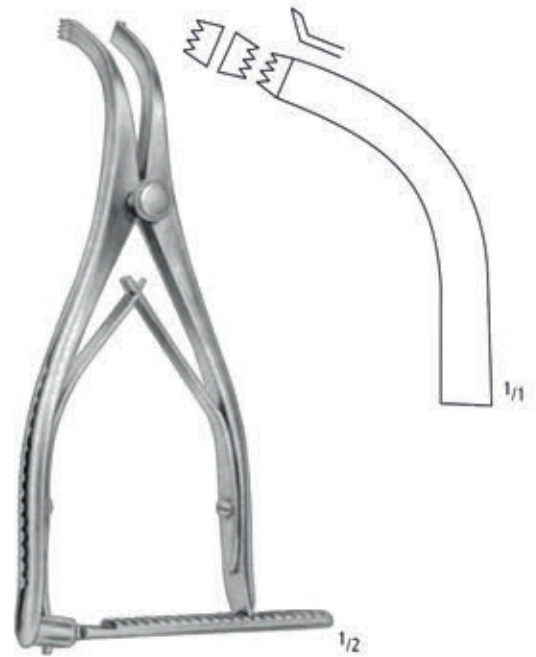

**INGE**  
**KS 593/17**  
 16,5 cm/6<sup>1</sup>/<sub>2</sub>"

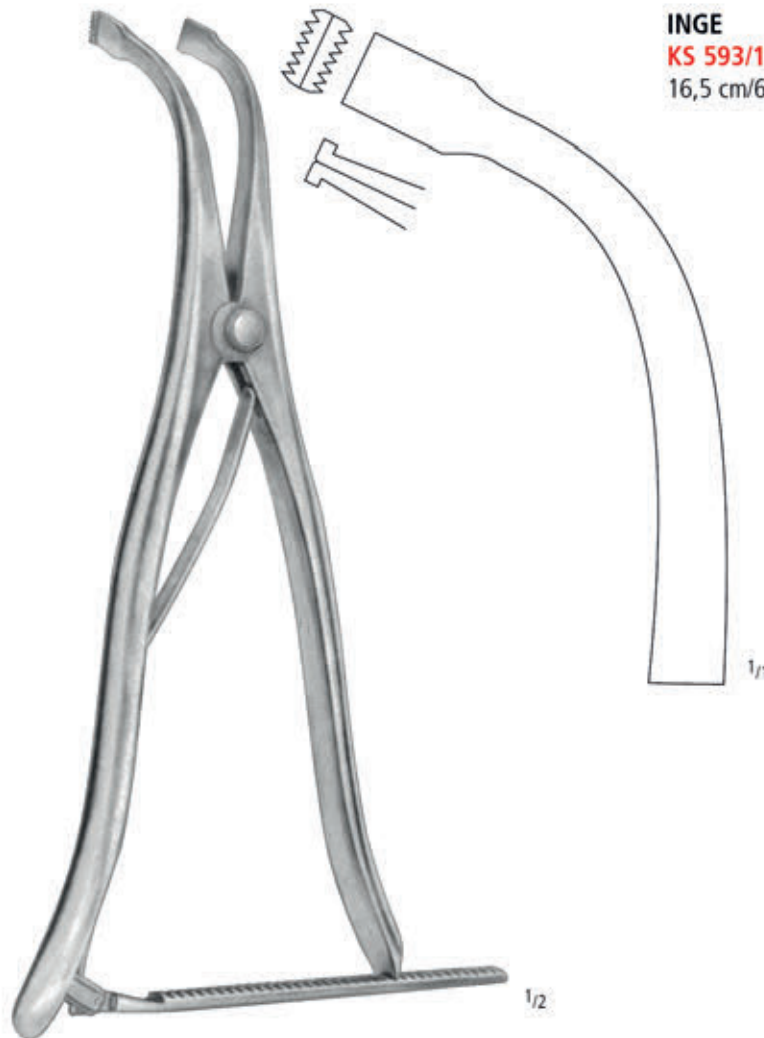

**INGE**  
**KS 594/27**  
 27,0 cm/10<sup>3</sup>/<sub>4</sub>"

Nervwurzelhaken  
 Nerve Root Retractors  
 Separadores de raiz de nervios  
 Rétracteurs pour racines nerveuses  
 Uncini per le radici dei nervi

AA

AB

AC

AE

AK

AO

AR

KA

**KS**

XR

XT



**HORSLEY**  
**KS 607/20**  
 20,0 cm/8"



**SACHS**  
**KS 608/21**  
 21,0 cm/8 1/2"



**SCOVILLE**  
**KS 609/23**  
 23,0 cm/9 1/4"



Nervwurzelhaken  
Nerve Root Retractors  
Separadores de raiz de nervios  
Rétracteurs pour racines nerveuses  
Uncini per le radici dei nervi

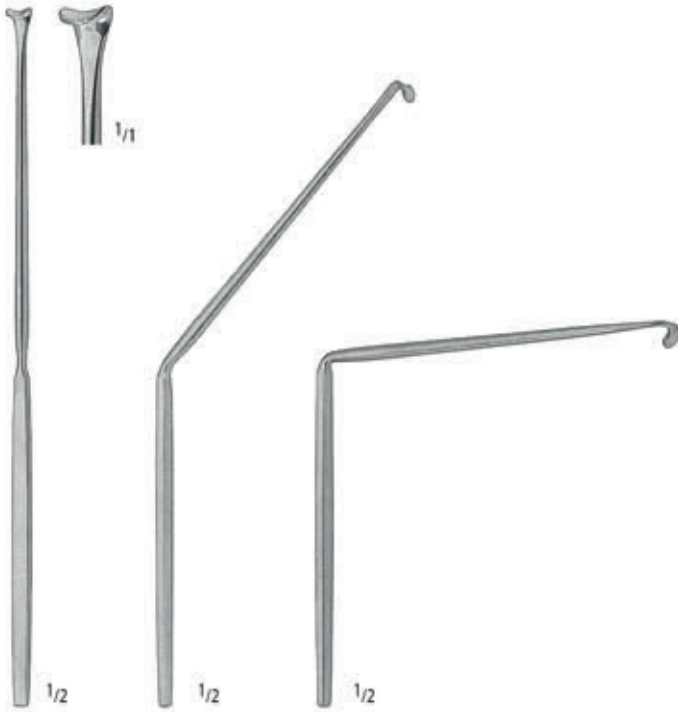

**LOVE**

45° 90°

**KS 610/01** **KS 610/02** **KS 610/03**  
19,0 cm/7 1/2" 19,0 cm/7 1/2" 19,0 cm/7 1/2"



Tip  
3 mm  
5 mm  
7 mm

L	L
7,0 cm/3"	10,0 cm/4"
<b>KS 610/11</b>	<b>KS 610/21</b>
<b>KS 610/12</b>	<b>KS 610/22</b>
<b>KS 610/13</b>	<b>KS 610/23</b>

**LOVE modif.**

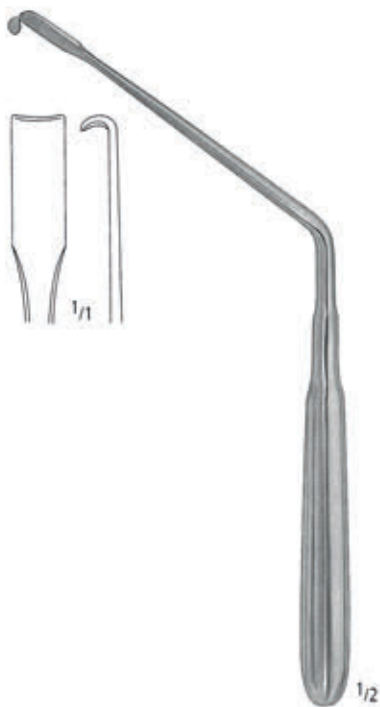

**KS 611/20**  
20,0 cm/8"

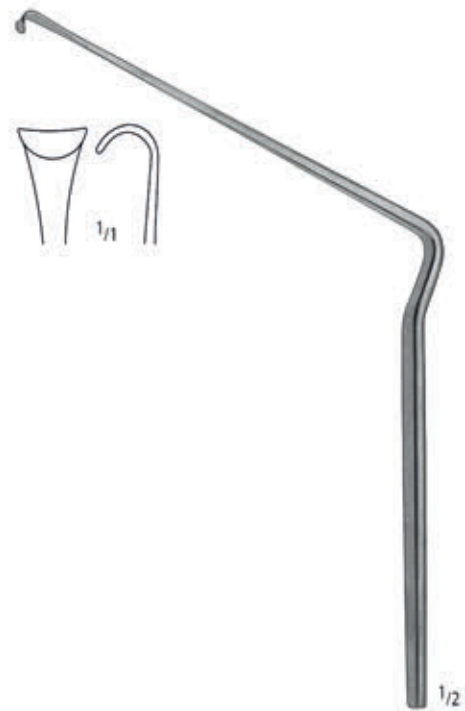

**MARTIN**  
**KS 612/21**  
21,0 cm/8 1/4"

Nervhaken  
Nerve Hooks  
Ganchos para nervios  
Crochets à nerfs  
Uncini per nervi

AA  
AB  
AC  
AE  
AK  
AO  
AR  
KA  
KS  
XR  
XT



**KS 613/01**

**KS 613/02**

**GRONINGEN**  
26,0 cm/10<sup>1</sup>/<sub>4</sub>"

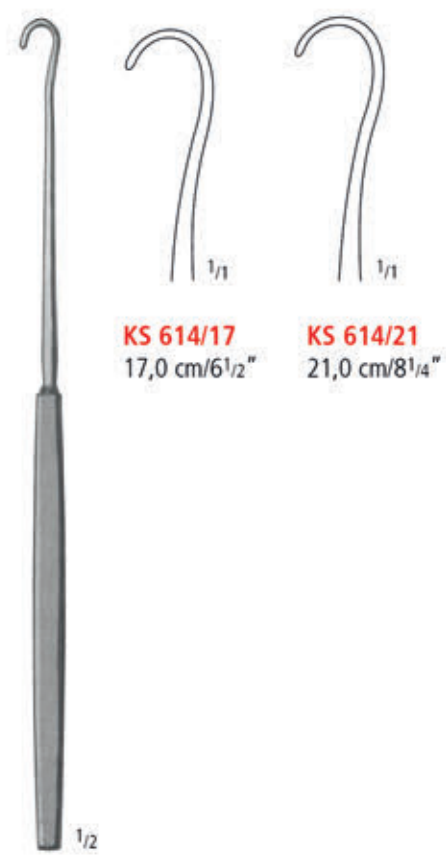

**KS 614/17**  
17,0 cm/6<sup>1</sup>/<sub>2</sub>"

**KS 614/21**  
21,0 cm/8<sup>1</sup>/<sub>4</sub>"

**SMITHWICK**



**DANDY**  
**KS 615/20**  
20,0 cm/8"

Nervhaken  
Nerve Hooks  
Ganchos para nervios  
Crochets à nerfs  
Uncini per nervi



**KRAYENBÜHL**  
18,5 cm/7<sup>1</sup>/<sub>4</sub>"



**KS 616/01**



**KS 616/02**



**KS 616/03**



**KS 616/04**



**BIEMER**  
**KS 617/16**  
16,0 cm/6<sup>1</sup>/<sub>4</sub>"



**KS 618/01**



**KS 618/02**



**FISCH**  
18,5 cm/7<sup>1</sup>/<sub>4</sub>"

Durahaken  
 Dura Hooks  
 Ganchos para dura-madre  
 Crochets à dure-mère  
 Uncini per dura-madre

AA

AB

AC

AE

AK

AO

AR

KA

KS

XR

XT



**CUSHING**  
**KS 620/14**  
 14,0 cm/5 1/2"



**ADSON**  
**KS 621/20**  
 20,0 cm/8"



**GRAHAM**  
**KS 622/16**  
 16,5 cm/6 1/2"

Dura Dissektoren  
 Dura Dissectors  
 Disecadores para dura-madre  
 Dissecteurs à dure-mère  
 Dissetori per dura-madre





Dura Dissektoren  
 Dura Dissectors  
 Disecadores para dura-madre  
 Dissecteurs à dure-mère  
 Dissetori per dura-madre

AA

AB

AC

AE

AK

AO

AR

KA

KS

XR

XT



**SACHS**  
**KS 631/21**  
 21,0 cm/8<sup>1</sup>/<sub>4</sub>"



**SACHS**  
**KS 632/21**  
 21,0 cm/8<sup>1</sup>/<sub>4</sub>"



**FRAZIER**  
**KS 633/01**  
 15,0 cm/6"



**HOEN**  
**KS 633/02**  
 15,0 cm/6"



**HOEN**  
**KS 633/03**  
 15,0 cm/6"

Dura Dissektoren  
 Dura Dissectors  
 Disecadores para dura-madre  
 Dissecteurs à dure-mère  
 Dissetori per dura-madre



**KS 634/18**  
 18,0 cm/7"

**KS 635/20**  
 19,5 cm/7<sup>3</sup>/<sub>4</sub>"

**KS 634/24**  
 24,0 cm/9<sup>1</sup>/<sub>2</sub>"

**KS 635/24**  
 24,0 cm/9<sup>1</sup>/<sub>2</sub>"

**OLIVECRONA**

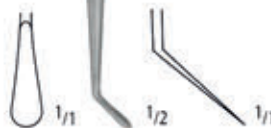

**MILLIGAN**  
**KS 636/21**  
 21,0 cm/8<sup>1</sup>/<sub>4</sub>"

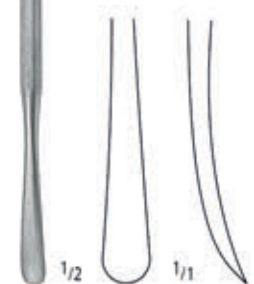

**KS 637/22**  
 22,0 cm/8<sup>3</sup>/<sub>4</sub>"

Dura Dissektoren  
 Dura Dissectors  
 Disecadores para dura-madre  
 Dissecteurs à dure-mère  
 Dissetori per dura-madre

AA  
 AB  
 AC  
 AE  
 AK  
 AO  
 AR  
 KA  
**KS**  
 XR  
 XT



**PENFIELD**  
**KS 638/01**  
 17,5 cm/7"



**PENFIELD**  
**KS 638/02**  
 19,5 cm/7<sup>3</sup>/<sub>4</sub>"



**PENFIELD**  
**KS 638/03**  
 19,5 cm/7<sup>3</sup>/<sub>4</sub>"



**PENFIELD**  
**KS 638/04**  
 20,5 cm/8"



**PENFIELD**  
**KS 638/05**  
 29,0 cm/11<sup>1</sup>/<sub>2</sub>"

Mikro-Instrumente  
 Micro Instruments  
 Instrumentos para microcirugia  
 Instruments pour la chirurgie micro  
 Strumenti per chirurgia micro



1/1 23,0 cm/9"



**KS 640/01**



**KS 640/02**



1/1 23,0 cm/9"



**KS 640/03**



**KS 640/04**



**KS 640/05**

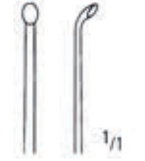

**KS 640/06**

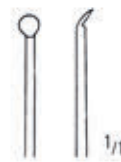

**KS 640/07**

Mikro-Instrumente  
 Micro Instruments  
 Instrumentos para microcirugía  
 Instruments pour la chirurgie micro  
 Strumenti per chirurgia micro



**KS 642/01**  
 23,0 cm/9"



**KS 642/02**  
 20,0 cm/8"

<sup>1/1</sup> CASPAR

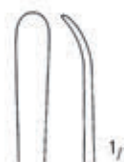

**KS 642/03**  
 23,0 cm/9"



**KS 642/05**  
 21,0 cm/8<sup>1</sup>/<sub>4</sub>"

<sup>1/1</sup> CASPAR



**KS 642/04**  
 23,0 cm/9"



**KS 642/06**  
 21,0 cm/8<sup>1</sup>/<sub>4</sub>"

AA  
 AB  
 AC  
 AE  
 AK  
 AO  
 AR  
 KA  
 KS  
 XR  
 XT





Mikro-Instrumente  
 Micro Instruments  
 Instrumentos para microcirugia  
 Instruments pour la chirurgie micro  
 Strumenti per chirurgia micro



**KS 643/19**  
 18,5 cm / 7 1/4"



1/1



**KS 643/22**  
 21,5 cm / 8 1/2"



1/1 **CASPAR**



**KS 644/01**  
 24,5 cm / 9 3/4"



**KS 644/02**  
 24,5 cm / 9 3/4"



**KS 644/03**  
 24,5 cm / 9 3/4"



**KS 644/04**  
 24,5 cm / 9 3/4"

Mikro-Instrumente  
 Micro Instruments  
 Instrumentos para microcirugía  
 Instruments pour la chirurgie micro  
 Strumenti per chirurgia micro

AA  
 AB  
 AC  
 AE  
 AK  
 AO  
 AR  
 KA  
 KS  
 XR  
 XT



20,0 cm/8"	<b>KS 647/01</b>	<b>KS 647/02</b>	<b>KS 647/03</b>	<b>KS 647/04</b>
23,0 cm/9 <sup>1</sup> / <sub>4</sub> "	<b>KS 648/01</b>	<b>KS 648/02</b>	<b>KS 648/03</b>	<b>KS 648/04</b>



20,0 cm/8"	<b>KS 647/05</b>	<b>KS 647/06</b>	<b>KS 647/07</b>	<b>KS 647/08</b>
23,0 cm/9 <sup>1</sup> / <sub>4</sub> "	<b>KS 648/05</b>	<b>KS 648/06</b>	<b>KS 648/07</b>	<b>KS 648/08</b>

1/1 SAMII

Mikro-Instrumente  
 Micro Instruments  
 Instrumentos para microcirugia  
 Instruments pour la chirurgie micro  
 Strumenti per chirurgia micro



18,5 cm/7 1/4"



**KS 650/01**



**KS 650/02**

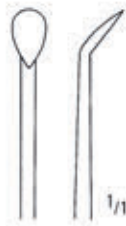

**KS 650/03**



**KS 650/04**



**KS 650/05**



18,5 cm/7 1/4"



**KS 650/06**

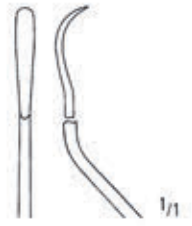

**KS 650/07**

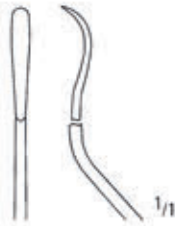

**KS 650/08**

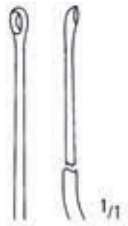

**KS 650/09**

Mikro-Instrumente  
 Micro Instruments  
 Instrumentos para microcirugía  
 Instruments pour la chirurgie micro  
 Strumenti per chirurgia micro

AA  
 AB  
 AC  
 AE  
 AK  
 AO  
 AR  
 KA  
 KS  
 XR  
 XT



**KOOS**  
 19,0 cm/7<sup>1</sup>/<sub>2</sub>"



**KS 652/01**



**KS 652/02**



**KS 652/03**



**KS 652/04**



**KS 652/05**



**KS 652/06**

Mikro-Instrumente  
 Micro Instruments  
 Instrumentos para microcirugia  
 Instruments pour la chirurgie micro  
 Strumenti per chirurgia micro



**KRAUS**  
**KS 653/19**  
 19,0 cm/7 1/2"



**KS 654/01**  
 19,0 cm/7 1/2"



**KS 654/02**  
 19,0 cm/7 1/2"



Mikro-Instrumente  
 Micro Instruments  
 Instrumentos para microcirugía  
 Instruments pour la chirurgie micro  
 Strumenti per chirurgia micro



**KS 656/19**

**JACOBSON**  
 19,0 cm/7 1/2"



**KS 658/01**



**KS 658/02**



**KS 658/03**

**JACOBSON**  
 18,5 cm/7 1/4"



**CASPAR**  
**KS 659/23**  
 23,0 cm/9"

AA  
 AB  
 AC  
 AE  
 AK  
 AO  
 AR  
 KA  
**KS**  
 XR  
 XT

Mikro-Instrumente  
 Micro Instruments  
 Instrumentos para microcirugia  
 Instruments pour la chirurgie micro  
 Strumenti per chirurgia micro



<sup>1/1</sup> **OKONEK**  
 23,0 cm/9"

3 mm



**KS 660/03**

4 mm



**KS 660/04**

5 mm



**KS 660/05**

8 mm



**KS 660/08**



<sup>1/1</sup> 19,0 cm/7 1/2"



**KS 665/01**



**KS 665/02**



**KS 665/03**



**KS 665/04**

Mikro-Instrumente  
 Micro Instruments  
 Instrumentos para microcirugía  
 Instruments pour la chirurgie micro  
 Strumenti per chirurgia micro

AA

AB

AC

AE

AK

AO

AR

KA

KS

XR

XT

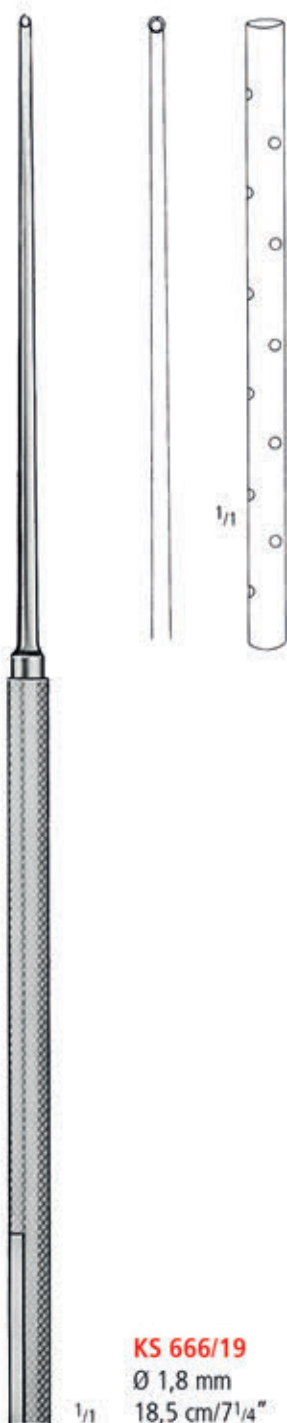

**KS 666/19**  
 Ø 1,8 mm  
 18,5 cm/7 1/4"



**KS 670/00**

**KS 670/01**

**KS 670/02**

12,5 cm/5"

Rhoton Mikro Dissektoren  
 Rhoton Micro Dissectors  
 Rhoton micro disecadores  
 Rhoton micro dissecteurs  
 Rhoton micro dissetori



**RHOTON**



**KS 680/01**



**KS 680/02**



**KS 680/03**



**KS 680/04**



**KS 680/05**



**KS 680/06**



**KS 680/07**



**KS 680/08**



**KS 680/09**

Rhoton Mikro Dissektoren  
 Rhoton Micro Dissectors  
 Rhoton micro disecadores  
 Rhoton micro dissecteurs  
 Rhoton micro dissetori



**RHOTON**



**KS 680/10**



**KS 680/11**



**KS 680/12**



**KS 680/13**



**KS 680/14**



**KS 680/15**

**KS 680/00 = KS 680/01 - KS 680/15**

Set komplett, 15 Dissektoren  
 Set complete, 15 dissectors  
 Set completo, 15 disecadores  
 Jeu complet, 15 dissecteurs  
 Set completo, 15 dissetori

AA  
 AB  
 AC  
 AE  
 AK  
 AO  
 AR  
 KA  
 KS  
 XR  
 XT



Mikro-Instrumente  
 Micro Instruments  
 Instrumentos para microcirugia  
 Instruments pour la chirurgie micro  
 Strumenti per la chirurgia micro

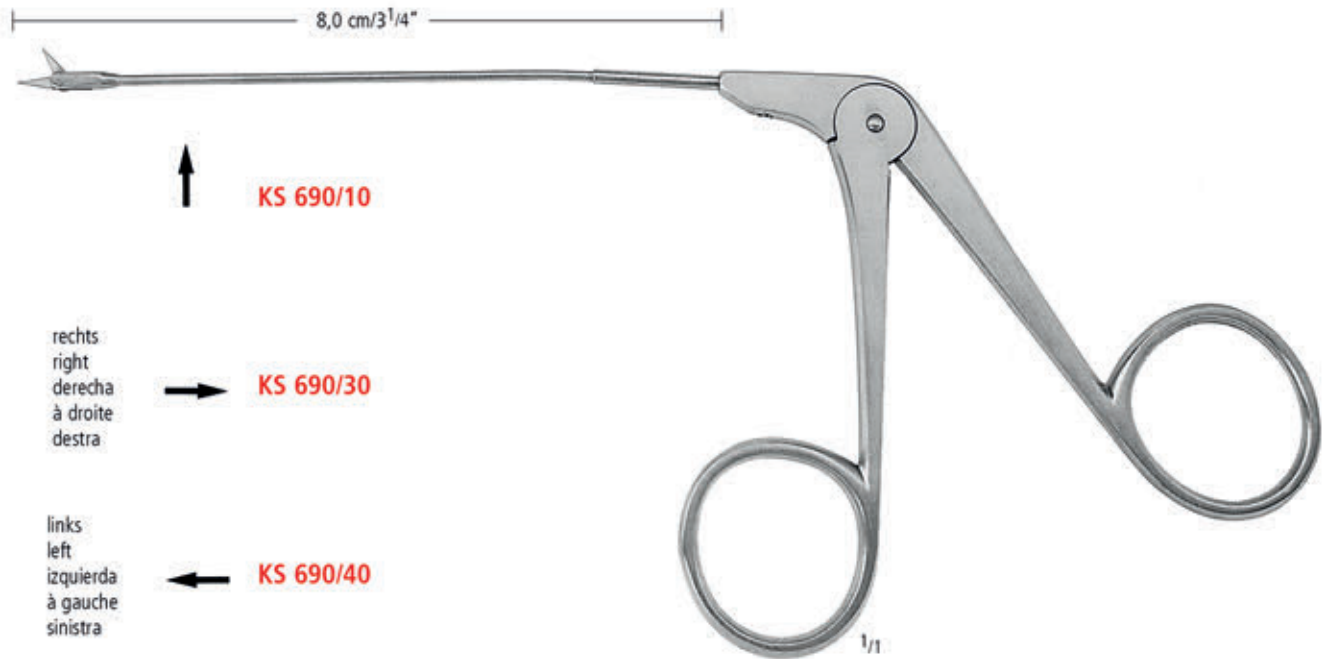

**BELLUCCI**

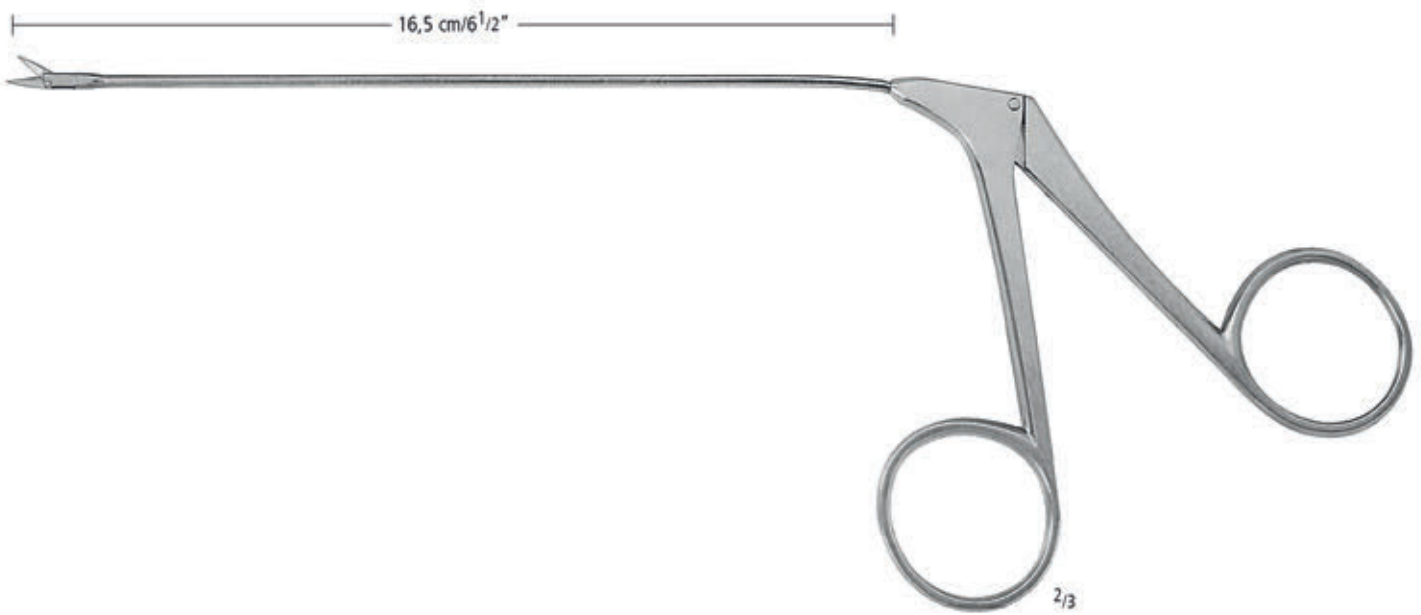

**FAHLBUSCH**  
**KS 693/17**

Mikro-Instrumente  
 Micro Instruments  
 Instrumentos para microcirugía  
 Instruments pour la chirurgie micro  
 Strumenti per la chirurgia micro

AA  
 AB  
 AC  
 AE  
 AK  
 AO  
 AR  
 KA  
 KS  
 XR  
 XT

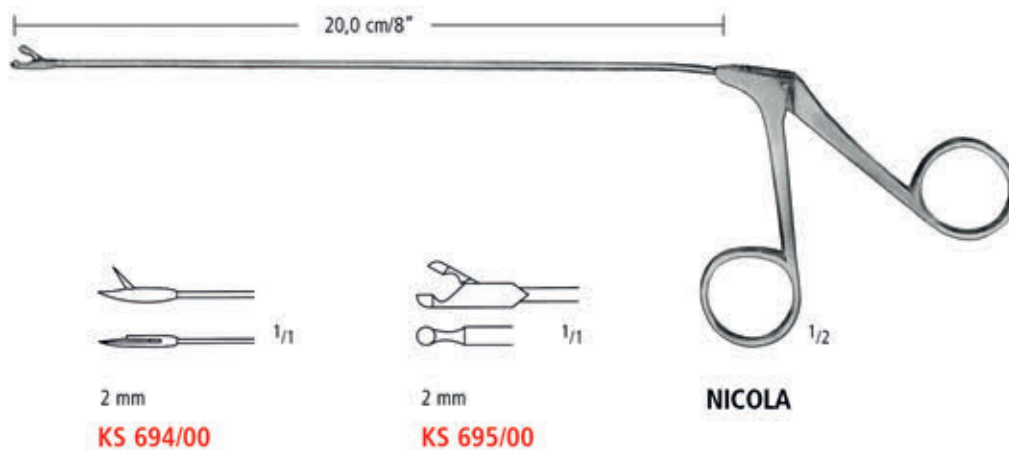

↑ 30° **KS 694/10** **KS 695/10**

rechts  
 right  
 derecha  
 à droite  
 destra

→ **KS 694/30** **KS 695/30**

links  
 left  
 izquierda  
 à gauche  
 sinistra

← **KS 694/40** **KS 695/40**

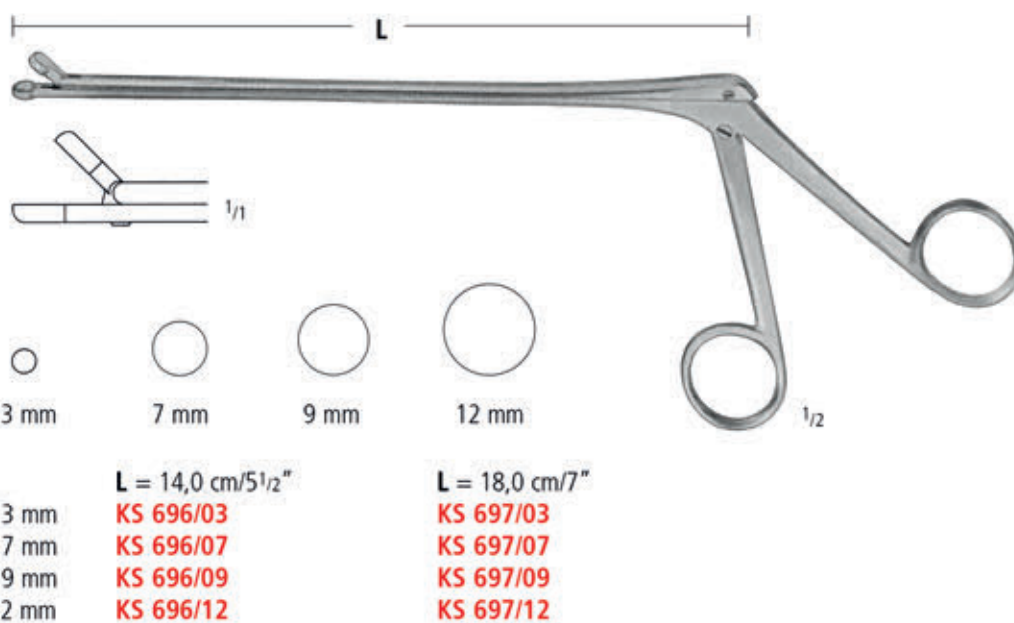

Laminektomie-Stanzen  
 Laminectomy Punches  
 Pinzas cortantes para discos intervertebrales  
 Pincas emporte-pièces pour lames intervertébrales  
 Pinze taglianti per dischi intervertebrali



**KERRISON**

Also available in  
**TITANIUM**

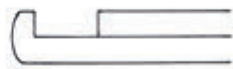

1 mm	15,0 cm/6"	18,0 cm/7"	20,0 cm/8"
2 mm	<b>KS 700/01</b>	<b>KS 701/01</b>	<b>KS 702/01</b>
3 mm	<b>KS 700/02</b>	<b>KS 701/02</b>	<b>KS 702/02</b>
5 mm	<b>KS 700/03</b>	<b>KS 701/03</b>	<b>KS 702/03</b>
	<b>KS 700/05</b>	<b>KS 701/05</b>	<b>KS 702/05</b>

Also available in  
**TITANIUM**

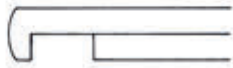

1 mm	15,0 cm/6"	18,0 cm/7"	20,0 cm/8"
2 mm	<b>KS 706/01</b>	<b>KS 707/01</b>	<b>KS 708/01</b>
3 mm	<b>KS 706/02</b>	<b>KS 707/02</b>	<b>KS 708/02</b>
5 mm	<b>KS 706/03</b>	<b>KS 707/03</b>	<b>KS 708/03</b>
	<b>KS 706/05</b>	<b>KS 707/05</b>	<b>KS 708/05</b>



1 mm	15,0 cm/6"	18,0 cm/7"	20,0 cm/8"
2 mm	<b>KS 712/01</b>	<b>KS 713/01</b>	<b>KS 714/01</b>
3 mm	<b>KS 712/02</b>	<b>KS 713/02</b>	<b>KS 714/02</b>
5 mm	<b>KS 712/03</b>	<b>KS 713/03</b>	<b>KS 714/03</b>
	<b>KS 712/05</b>	<b>KS 713/05</b>	<b>KS 714/05</b>

Laminektomie-Stanzen  
 Laminectomy Punches  
 Pinzas cortantes para discos intervertebrales  
 Pincas emporte-pièces pour lames intervertébrales  
 Pinze taglienti per dischi intervertebrali



easyClean<sup>®</sup>

ZERLEGBAR  
 DETACHABLE  
 DESMONTABLE  
 DEMONTABLE  
 SMONTABILE



1 mm  
 2 mm  
 3 mm  
 4 mm  
 5 mm

18,0 cm/7"  
 KS 701/11  
 KS 701/12  
 KS 701/13  
 KS 701/14  
 KS 701/15

20,0 cm/8"  
 KS 702/11  
 KS 702/12  
 KS 702/13  
 KS 702/14  
 KS 702/15

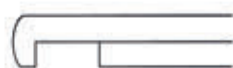

2 mm  
 3 mm  
 4 mm  
 5 mm

18,0 cm/7"  
 KS 707/12  
 KS 707/13  
 KS 707/14  
 KS 707/15

20,0 cm/8"  
 KS 708/12  
 KS 708/13  
 KS 708/14  
 KS 708/15



1 mm  
 2 mm  
 3 mm  
 4 mm  
 5 mm

18,0 cm/7"  
 KS 713/11  
 KS 713/12  
 KS 713/13  
 KS 713/14  
 KS 713/15

20,0 cm/8"  
 KS 714/11  
 KS 714/12  
 KS 714/13  
 KS 714/14  
 KS 714/15

AA

AB

AC

AE

AK

AO

AR

KA

KS

XR

XT

Laminektomie-Stanzen  
 Laminectomy Punches  
 Pinzas cortantes para discos intervertebrales  
 Pincas emporte-pièces pour lames intervertébrales  
 Pinze taglianti per dischi intervertebrali

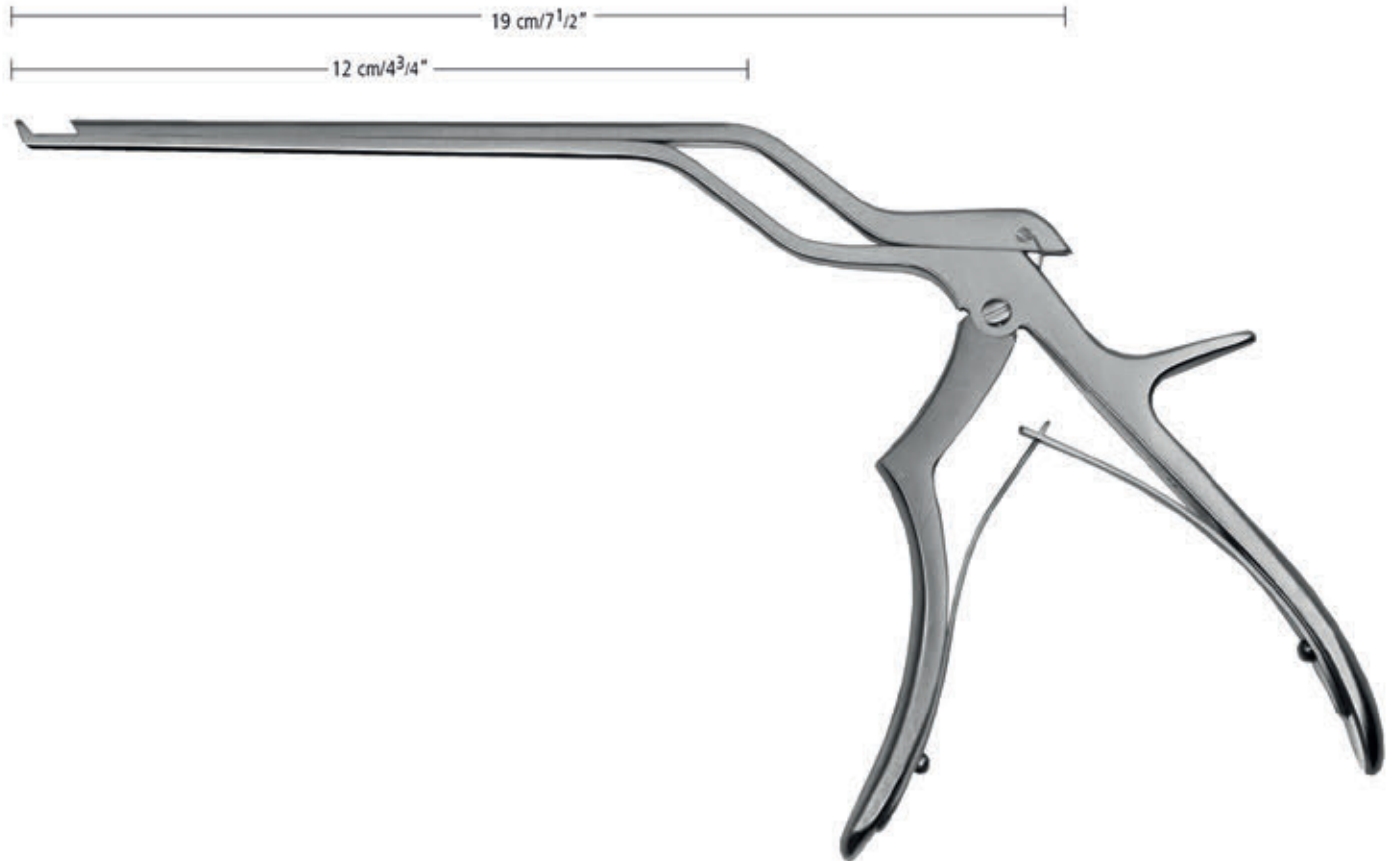

**KERRISON-BAJONETT**

12,0 cm / 4 3/4"

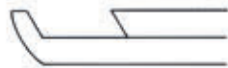

- 2 mm
- 3 mm
- 4 mm
- 5 mm

- KS 715/12**
- KS 715/13**
- KS 715/14**
- KS 715/15**



Laminektomie-Stanzen  
 Laminectomy Punches  
 Pinzas cortantes para discos intervertebrales  
 Pincas emporte-pièces pour lames intervertébrales  
 Pinze taglienti per dischi intervertebrali



großer Griff  
 large handle  
 mango grande  
 branche grande  
 impugnatura grande

**KERRISON-COLCLOUGH**

Also available in  
**TITANIUM**



2 mm  
 3 mm  
 4 mm  
 5 mm

15,0 cm/6"

**KS 720/02**  
**KS 720/03**  
**KS 720/04**  
**KS 720/05**

18,0 cm/7"

**KS 721/02**  
**KS 721/03**  
**KS 721/04**  
**KS 721/05**

20,0 cm/8"

**KS 722/02**  
**KS 722/03**  
**KS 722/04**  
**KS 722/05**

30,0 cm/12"

**KS 725/02**  
**KS 725/03**  
**KS 725/04**  
**KS 725/05**

Also available in  
**TITANIUM**



2 mm  
 3 mm  
 4 mm  
 5 mm

15,0 cm/6"

**KS 726/02**  
**KS 726/03**  
**KS 726/04**  
**KS 726/05**

18,0 cm/7"

**KS 727/02**  
**KS 727/03**  
**KS 727/04**  
**KS 727/05**

20,0 cm/8"

**KS 728/02**  
**KS 728/03**  
**KS 728/04**  
**KS 728/05**

30,0 cm/12"

**KS 731/02**  
**KS 731/03**  
**KS 731/04**  
**KS 731/05**



2 mm  
 3 mm  
 4 mm  
 5 mm

15,0 cm/6"

**KS 732/02**  
**KS 732/03**  
**KS 732/04**  
**KS 732/05**

18,0 cm/7"

**KS 733/02**  
**KS 733/03**  
**KS 733/04**  
**KS 733/05**

20,0 cm/8"

**KS 734/02**  
**KS 734/03**  
**KS 734/04**  
**KS 734/05**

30,0 cm/12"

**KS 737/02**  
**KS 737/03**  
**KS 737/04**  
**KS 737/05**

AA  
 AB  
 AC  
 AE  
 AK  
 AO  
 AR  
 KA  
 KS  
 XR

XT

Laminektomie-Zangen  
 Laminectomy Rongeurs  
 Pinzas cortantes para laminectomía  
 Pincas emporte-pièces à laminectomie  
 Pinze taglianti per laminectomia



Also available in  
**TITANIUM**

**CUSHING**  
**LOVE-GRUENWALD**  
**SPURLING**



**CUSHING**  
 2 x 10 mm



13,0 cm/5"  
 15,0 cm/6"  
 18,0 cm/7"  
 20,0 cm/8"  
 25,0 cm/10"  
 30,0 cm/12"

**KS 742/00**  
**KS 742/04**  
**KS 742/08**  
**KS 742/12**  
**KS 742/16**  
**KS 742/20**

**KS 742/01**  
**KS 742/05**  
**KS 742/09**  
**KS 742/13**  
**KS 742/17**  
**KS 742/21**

**KS 742/03**  
**KS 742/07**  
**KS 742/11**  
**KS 742/15**  
**KS 742/19**  
**KS 742/23**

**LOVE-GRUENWALD**  
 3 x 10 mm



13,0 cm/5"  
 15,0 cm/6"  
 18,0 cm/7"  
 20,0 cm/8"  
 25,0 cm/10"  
 30,0 cm/12"

**KS 743/00**  
**KS 743/04**  
**KS 743/08**  
**KS 743/12**  
**KS 743/16**  
**KS 743/20**

**KS 743/01**  
**KS 743/05**  
**KS 743/09**  
**KS 743/13**  
**KS 743/17**  
**KS 743/21**

**KS 743/03**  
**KS 743/07**  
**KS 743/11**  
**KS 743/15**  
**KS 743/19**  
**KS 743/23**

**SPURLING**  
 4 x 10 mm



13,0 cm/5"  
 15,0 cm/6"  
 18,0 cm/7"  
 20,0 cm/8"  
 25,0 cm/10"  
 30,0 cm/12"

**KS 744/00**  
**KS 744/04**  
**KS 744/08**  
**KS 744/12**  
**KS 744/16**  
**KS 744/20**

**KS 744/01**  
**KS 744/05**  
**KS 744/09**  
**KS 744/13**  
**KS 744/17**  
**KS 744/21**

**KS 744/03**  
**KS 744/07**  
**KS 744/11**  
**KS 744/15**  
**KS 744/19**  
**KS 744/23**

Laminektomie-Zangen  
 Laminectomy Rongeurs  
 Pinzas cortantes para laminectomía  
 Pincas emporte-pièces à laminectomie  
 Pinze taglienti per laminectomia

AA  
 AB  
 AC  
 AE  
 AK  
 AO  
 AR  
 KA  
 KS  
 XR  
 XT



 1/1  
 2 x 3 mm  
**KS 750/03**

 1/1  
 2 x 5 mm  
**KS 750/05**

 1/2  
**SELVERSTONE**

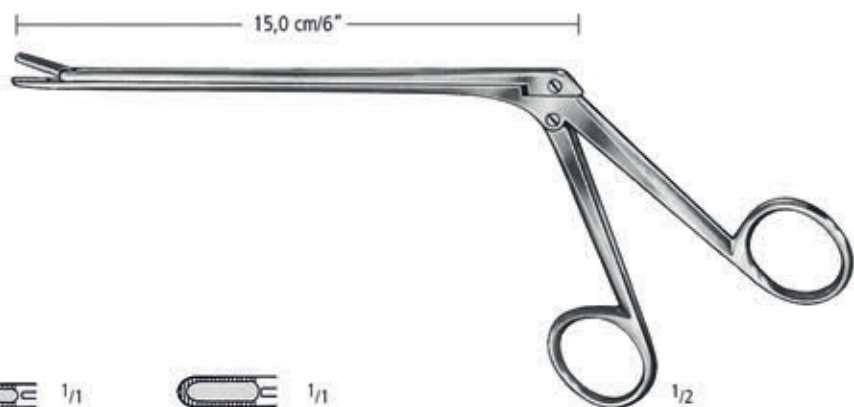

 1/1  
 2 x 10 mm  
**KS 752/02**

 1/1  
 3 x 10 mm  
**KS 752/03**

 1/1  
 4 x 10 mm  
**KS 752/04**

 1/2  
**SCHLESINGER**

Laminektomie-Zangen  
 Laminectomy Rongeurs  
 Pinzas cortantes para laminectomía  
 Pincas emporte-pièces à laminectomie  
 Pinze taglianti per laminectomia

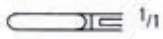

2 x 10 mm  
**KS 754/02**

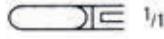

3 x 10 mm  
**KS 754/03**



4 x 10 mm  
**KS 754/04**

**CASPAR**



6 x 10 mm

**CLOWARD**



**KS 756/01**



**KS 756/02**



**KS 756/03**







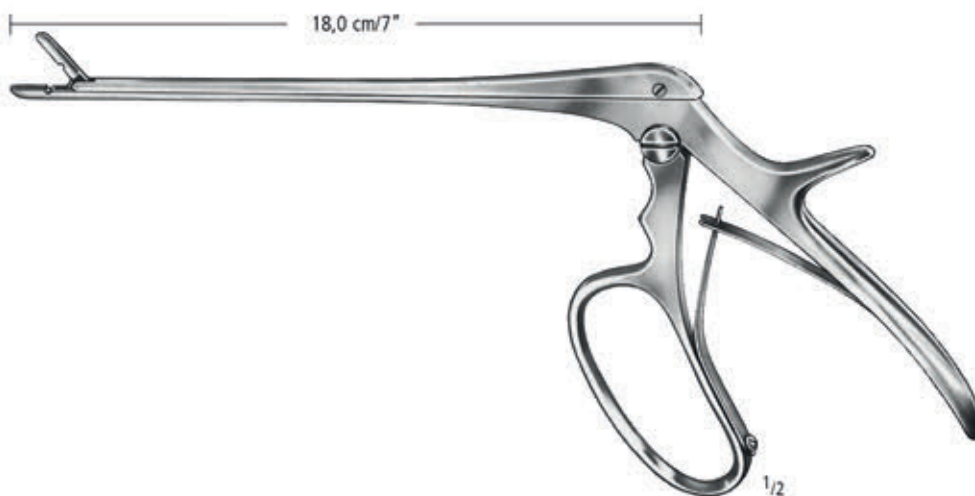

Laminektomie-Zangen  
 Laminectomy Rongeurs  
 Pinzas cortantes para laminectomía  
 Pincas emporte-pièces à laminectomie  
 Pinze taglienti per laminectomia

AA  
 AB  
 AC  
 AE  
 AK  
 AO  
 AR  
 KA  
 KS  
 XR  
 XT



**FERRIS-SMITH-CUSHING**

	 1/1	 1/1	 1/1	 1/1
	2 x 10 mm	3 x 10 mm	4 x 10 mm	6 x 12 mm
 1/1	<b>KS 762/00</b>	<b>KS 763/00</b>	<b>KS 764/00</b>	<b>KS 766/00</b>
 1/1	<b>KS 762/01</b>	<b>KS 763/01</b>	<b>KS 764/01</b>	<b>KS 766/01</b>
 1/1	<b>KS 762/03</b>	<b>KS 763/03</b>	<b>KS 764/03</b>	<b>KS 766/03</b>



**OLDBERG**  
**KS 770/00**



Laminektomie-Stanzen  
Laminectomy Punches  
Pinzas cortantes para discos intervertebrales  
Pincas emporte-pièces pour lames intervertébrales  
Pinze taglianti per dischi intervertebrali

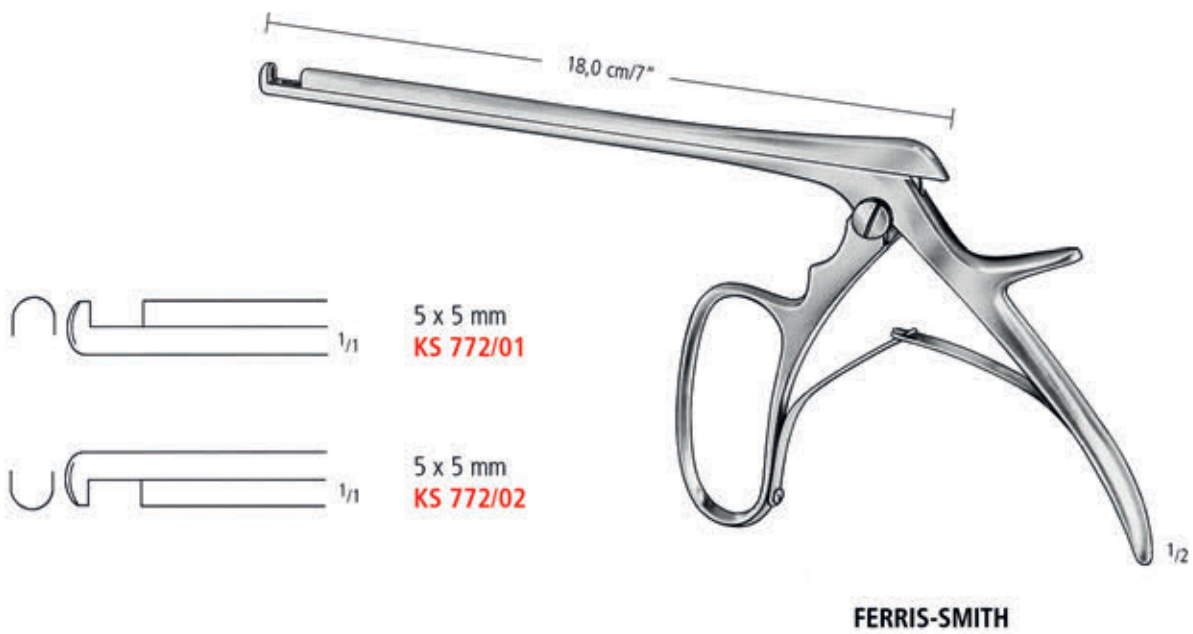

Laminektomie-Stanzen  
 Laminectomy Punches  
 Pinzas cortantes para discos intervertebrales  
 Pincas emporte-pièces pour lames intervertébrales  
 Pinze taglienti per dischi intervertebrali

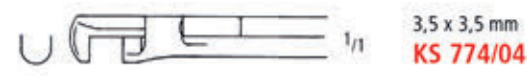
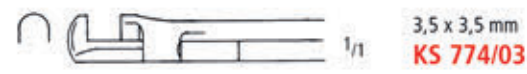
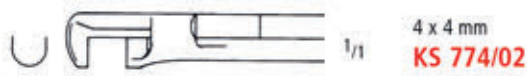
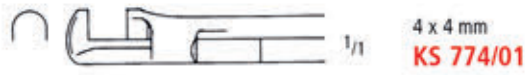

**HAJEK-KOFFLER**



AA  
 AB  
 AC  
 AE  
 AK  
 AO  
 AR  
 KA  
 KS  
 XR  
 XT

Laminektomie-Stanzen  
 Laminectomy Punches  
 Pinzas cortantes para discos intervertebrales  
 Pinces emporte-pièces pour lames intervertébrales  
 Pinze taglianti per dischi intervertebrali

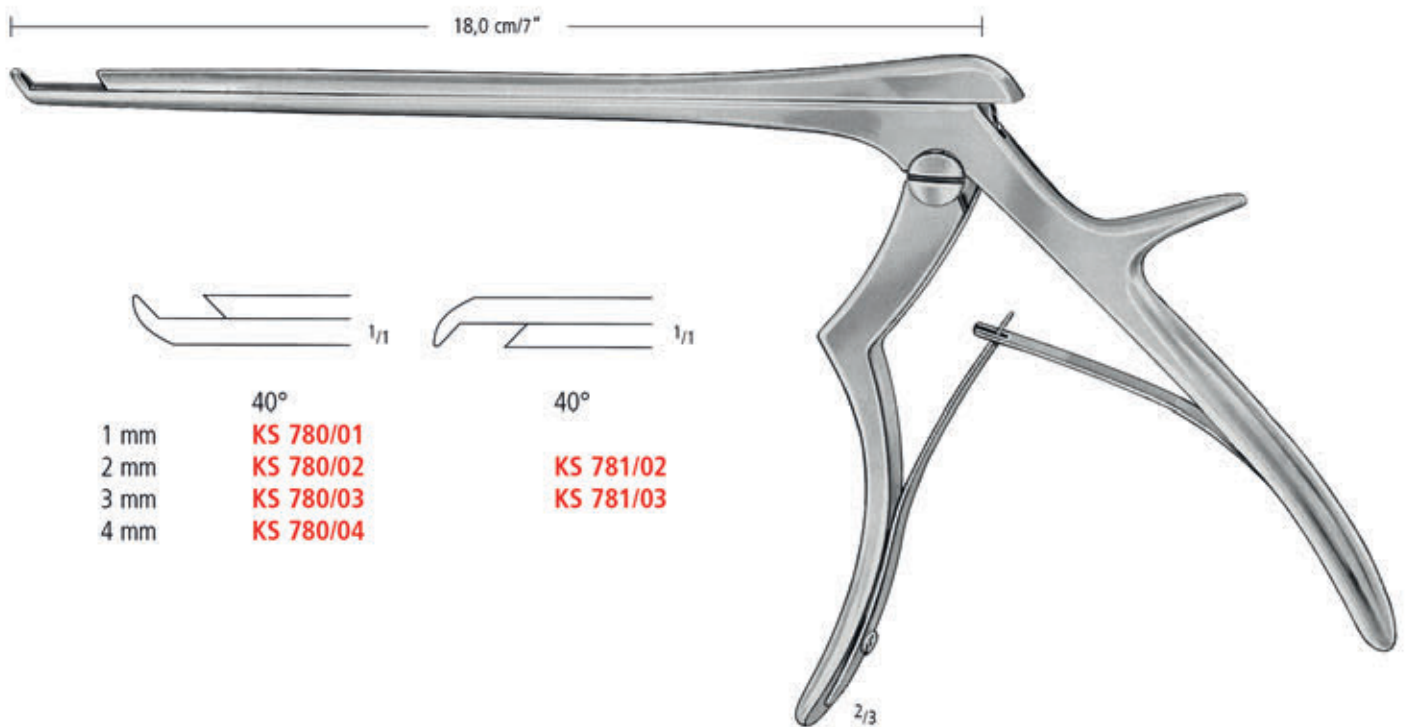

40°  
 1 mm **KS 780/01**  
 2 mm **KS 780/02**  
 3 mm **KS 780/03**  
 4 mm **KS 780/04**

40°  
**KS 781/02**  
**KS 781/03**

**PLATTFUSS**

Hypophysen-Instrumente  
 Pituitary Instruments  
 Instrumentos para hipófisis  
 Instruments pour la chirurgie pituitaire  
 Strumenti per ipofisi cerebrale

AA  
 AB  
 AC  
 AE  
 AK  
 AO  
 AR  
 KA  
**KS**  
 XR  
 XT

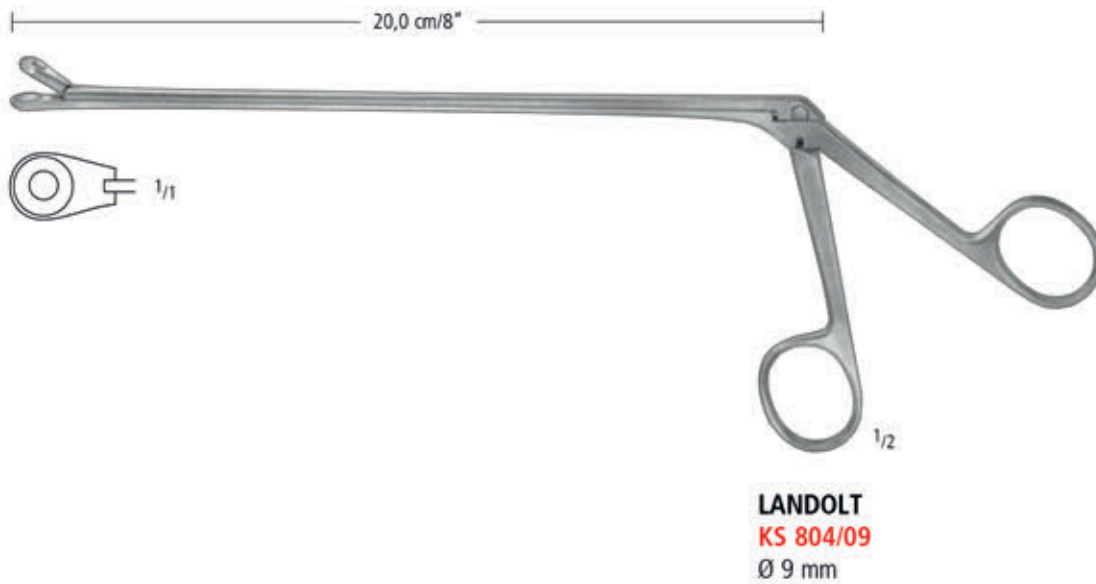
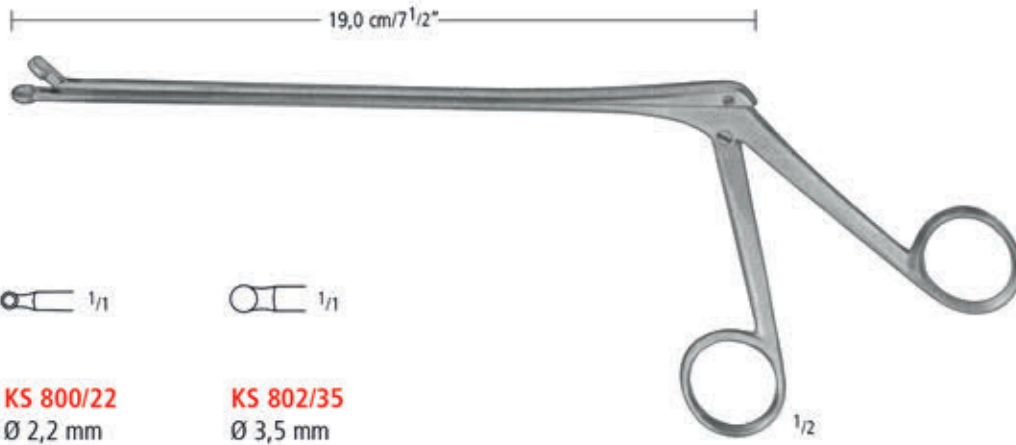

Hypophysen-Instrumente  
 Pituitary Instruments  
 Instrumentos para hipófisis  
 Instruments pour la chirurgie pituitaire  
 Strumenti per ipofisi cerebrale



**CUSHING-LANDOLT**

<b>L</b>	
70 x 15 mm	<b>KS 820/01</b>
90 x 15 mm	<b>KS 820/02</b>
110 x 15 mm	<b>KS 820/03</b>



**LANDOLT**  
**KS 821/21**  
 21,5 cm/8 1/2"



**COTTLE**  
**KS 822/04**  
 18 cm/7"



Hypophysen-Instrumente  
 Pituitary Instruments  
 Instrumentos para hipófisis  
 Instruments pour la chirurgie pituitaire  
 Strumenti per ipofisi cerebrale



**RAY**  
 18,0 cm/7<sup>1</sup>/<sub>4</sub>"



Ø 4 mm  
**KS 830/18**



Ø 4 mm  
**KS 831/18**

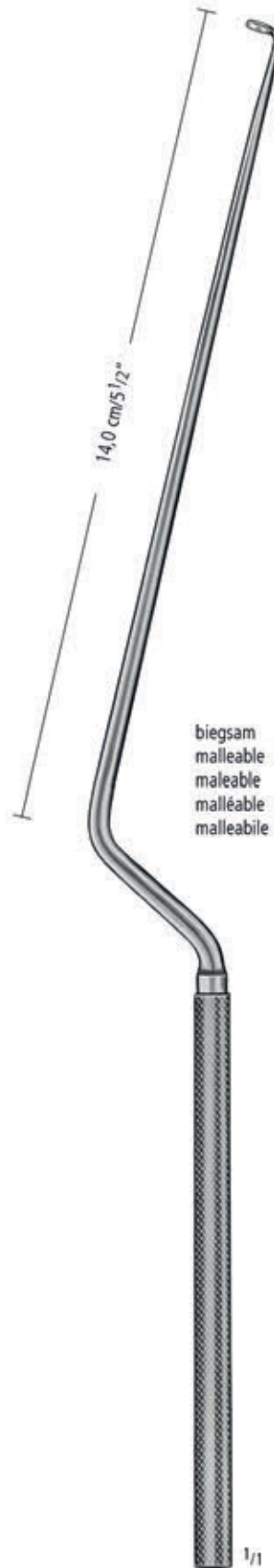

biegsam  
 malleable  
 maleable  
 malléable  
 malleabile

**HARDY**  
 26,0 cm/10<sup>1</sup>/<sub>4</sub>"



Ø 4 mm  
**KS 832/04**



Ø 6 mm  
**KS 832/06**

AA

AB

AC

AE

AK

AO

AR

KA

**KS**

XR

XT

Hypophysen-Instrumente  
 Pituitary Instruments  
 Instrumentos para hipófisis  
 Instruments pour la chirurgie pituitaire  
 Strumenti per ipofisi cerebrale



9,5 cm/3 3/4"



**KS 834/01**  
 biegsam  
 malleable  
 maleable  
 malléable  
 malleabile



**KS 834/02**  
 biegsam  
 malleable  
 maleable  
 malléable  
 malleabile



**KS 835/22**



**KS 836/22**

**NICOLA**  
 26,0 cm/10 1/2"

Hypophysen-Instrumente  
 Pituitary Instruments  
 Instrumentos para hipofisis  
 Instruments pour la chirurgie pituitaire  
 Strumenti per ipofisi cerebrale



**HARDY**  
 1/1 26,0 cm / 10 1/4"



**KS 837/01**  
 stumpf  
 blunt  
 romo  
 mousse  
 smusso



**KS 837/02**  
 stumpf  
 blunt  
 romo  
 mousse  
 smusso



**KS 837/03**  
 scharf  
 sharp  
 cortante  
 tranchante  
 tagliente



**KS 837/04**  
 scharf  
 sharp  
 cortante  
 tranchante  
 tagliente



**HARDY**  
**KS 838/25**



**HARDY-FAHLBUSCH**  
**KS 839/01**  
 scharf  
 sharp  
 cortante  
 tranchante  
 tagliente



**HARDY-FAHLBUSCH**  
**KS 839/02**  
 scharf  
 sharp  
 cortante  
 tranchante  
 tagliente

AA  
 AB  
 AC  
 AE  
 AK  
 AO  
 AR  
 KA  
 KS  
 XR  
 XT

Hypophysen-Instrumente  
 Pituitary Instruments  
 Instrumentos para hipófisis  
 Instruments pour la chirurgie pituitaire  
 Strumenti per ipofisi cerebrale

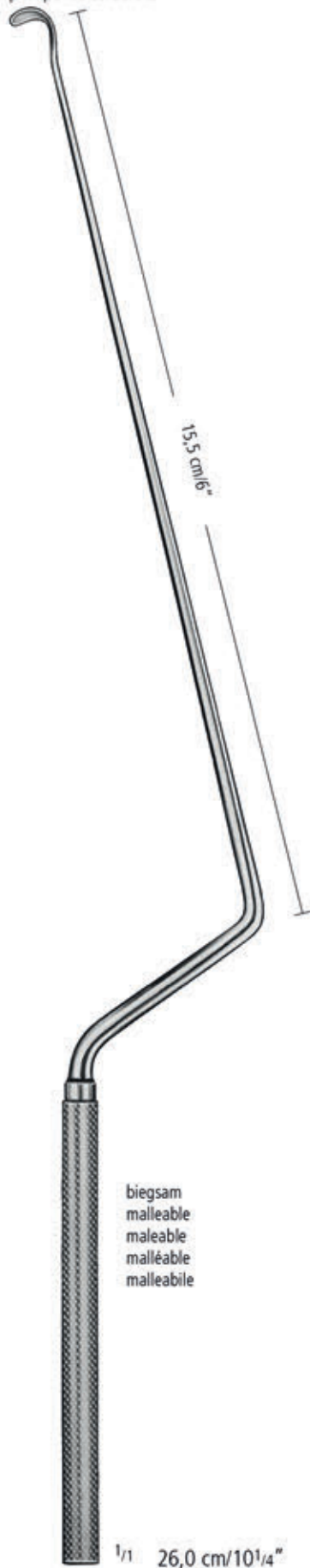

**LANDOLT**  
**KS 840/01**



**LANDOLT**  
**KS 840/02**



**LANDOLT**  
**KS 841/26**



**LANDOLT**  
**KS 842/26**



**LANDOLT**  
**KS 843/26**



**FAHLBUSCH**  
**KS 844/26**



**FAHLBUSCH**  
**KS 845/26**

biegsam  
 malleable  
 malleable  
 malléable  
 malleabile

<sup>1/1</sup> 26,0 cm/10<sup>1/4</sup>\"/>

Hypophysen-Instrumente  
 Pituitary Instruments  
 Instrumentos para hipófisis  
 Instruments pour la chirurgie pituitaire  
 Strumenti per ipofisi cerebrale

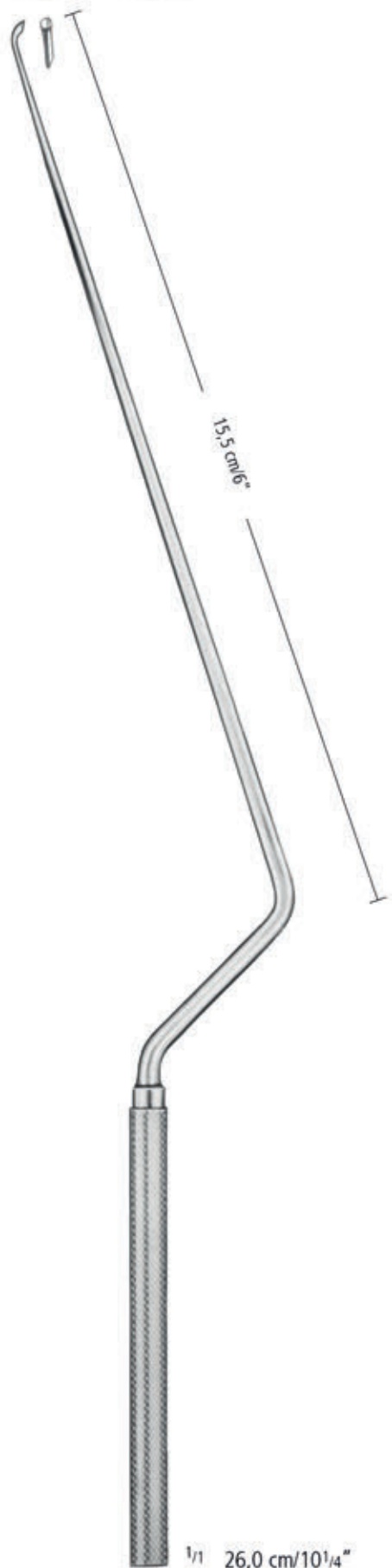

**HOSOBUCHI**  
 KS 846/26

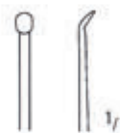

**LANDOLT-REULEN**  
 Ø 2,2 mm  
 KS 847/22



**LANDOLT-REULEN**  
 Ø 3,2 mm  
 KS 847/32



**LANDOLT-REULEN**  
 Ø 2,5 mm  
 KS 848/25



**LANDOLT-REULEN**  
 Ø 1,7 mm  
 KS 849/17



**LANDOLT-REULEN**  
 Ø 2,0 mm  
 KS 850/20

AA

AB

AC

AE

AK

AO

AR

KA

**KS**

XR

XT





ENDOSKOPIE  
ENDOSCOPY  
ENDOSCOPIA  
ENDOSCOPIE  
ENDOSCOPIA

**XR**

**nopa**<sup>®</sup> instruments

Unser komplettes **Endoskopie**-Programm finden Sie in Katalog **X - ENDOSKOPIE**.

For our complete program in **endoscopy** please refer to catalogue **X - ENDOSCOPY**.

Para nuestro programa completo de **endoscopia** vea el catálogo **X - ENDOSCOPIA**.

Pour notre programme complet d'**endoscopie** voir le catalogue **X - ENDOSCOPIE**.

Per la nostra gamma completa di **endoscopia** la preghiamo di consultare il catalogo **X - ENDOSCOPIA**.



Anschlußkabel  
 Connection Cords  
 Cables de connexion  
 Câbles de raccordement  
 Cavi da connessione

monopolar

bipolar



MARTIN/BERCHTOLD

300 cm **XR 827/03**  
 500 cm **XR 827/05**

**XR 828/03**  
**XR 828/05**

**XR 830/03**  
**XR 830/05**

monopolar

bipolar

monopolar

bipolar



300 cm **ERBE**  
**XR 831/03**  
 500 cm **XR 831/05**  
 (ACC/ICC)

**ERBE**  
**XR 831/13**  
 (T-Serie)

**ERBE/SELECT**  
**XR 832/03**  
**XR 832/05**

**ERBE**  
**XR 833/03**  
**XR 833/05**

**VALLEYLAB**  
**XR 834/03**  
**XR 834/05**  
 (in D nicht zulässig  
 nach MedGV)

ENDOSKOPIE ENDOSCOPY ENDOSCOPIA ENDOSCOPIO ENDOSCOPIA

Bi-Koagulations-Pinzetten  
 Bi-Coagulation-Forceps  
 Pinzas para la Bi-Coagulación  
 Pince pour la Bi-Coagulation  
 Pinze per la Bi-Coagulazione



16,0 cm/6 <sup>1</sup> / <sub>4</sub> "	<b>XR 890/16 A</b>	<b>XR 891/16 C</b>	<b>XR 894/16 C</b>		
16,0 cm/6 <sup>1</sup> / <sub>4</sub> "	<b>XR 890/16 C</b>	<b>XR 891/16 D</b>	<b>XR 894/16 D</b>		
16,0 cm/6 <sup>1</sup> / <sub>4</sub> "	<b>XR 890/16 E</b>	<b>XR 891/16 E</b>			
20,0 cm/8"	<b>XR 890/20 A</b>	<b>XR 891/20 A</b>	<b>XR 894/20 A</b>		
20,0 cm/8"	<b>XR 890/20 C</b>	<b>XR 891/20 C</b>	<b>XR 894/20 C</b>	<b>XR 895/20 C</b>	<b>XR 896/20 C</b>
20,0 cm/8"	<b>XR 890/20 E</b>	<b>XR 891/20 F</b>	<b>XR 894/20 E</b>		
20,0 cm/8"			<b>XR 894/20 F</b>		
22,0 cm/8 <sup>3</sup> / <sub>4</sub> "	<b>XR 890/22 A</b>	<b>XR 891/22 C</b>	<b>XR 894/22 D</b>		
22,0 cm/8 <sup>3</sup> / <sub>4</sub> "	<b>XR 890/22 C</b>		<b>XR 894/22 E</b>	<b>XR 896/22 C</b>	

A=2,0 mm

C=1,0 mm



D=0,5 mm

E=Nadel

F=Profil



11,0 cm/4 <sup>1</sup> / <sub>4</sub> "	<b>XR 898/11 D</b>	<b>XR 899/11 D</b>
11,0 cm/4 <sup>1</sup> / <sub>4</sub> "	<b>XR 898/11 E</b>	<b>XR 899/11 E</b>





ENDOSKOPIE  
ENDOSCOPY  
ENDOSCOPIA  
ENDOSCOPIE  
ENDOSCOPIA

XT

nopa<sup>®</sup> instruments

Unser komplettes **Endoskopie**-Programm finden Sie in Katalog **X - ENDOSKOPIE**.

For our complete program in **endoscopy** please refer to catalogue **X - ENDOSCOPY**.

Para nuestro programa completo de **endoscopia** vea el catálogo **X - ENDOSCOPIA**.

Pour notre programme complet d'**endoscopie** voir le catalogue **X - ENDOSCOPIE**.

Per la nostra gamma completa di **endoscopia** la preghiamo di consultare il catalogo **X - ENDOSCOPIA**.





Kaltlichtkabel  
 Fibre optic cable  
 Cable fibra óptica  
 Câble fibre optique  
 Cavo fibra ottica



**Kaltlichtkabel-Grundkabel**  
**Basic fibre optic cable**

- |                  |                  |
|------------------|------------------|
| <b>XT 035/18</b> | Ø 3,5 mm, 180 cm |
| <b>XT 035/23</b> | Ø 3,5 mm, 230 cm |
| <b>XT 035/30</b> | Ø 3,5 mm, 300 cm |
| <b>XT 045/18</b> | Ø 4,5 mm, 180 cm |
| <b>XT 045/23</b> | Ø 4,5 mm, 230 cm |
| <b>XT 045/30</b> | Ø 4,5 mm, 300 cm |



- |                  |                  |
|------------------|------------------|
| <b>XT 070/18</b> | Ø 3,5 mm, 180 cm |
| <b>XT 070/23</b> | Ø 3,5 mm, 230 cm |
| <b>XT 070/30</b> | Ø 3,5 mm, 300 cm |

- >> **Zusätzliche Isolierung**
- >> **Metallspirale**
- >> **Silikonmantel**
- >> **Sterilisierbar**

- >> **Additionally insulated**
- >> **Metal spiral**
- >> **Silicon tube**
- >> **Autoclavable**

AA  
AB  
AC  
AE  
AK  
AO  
AR  
KA  
KS  
XR

**XT**

Adapter  
Adapter  
Adaptador  
Connexion  
Adattatore

Projektor-Seite  
Projector side

## Adapter

Endoskop-Seite  
Endoscope side

**XT 100/01**



**STORZ**



**XT 100/11**

**STORZ/WINTER + IBE  
OLYMPUS/STRYKER**

**XT 100/02**



**WOLF/HENKE-SASS**



**XT 100/12**

**WOLF/HENKE-SASS**

**XT 100/03**



**ACM/HEINE**



**XT 100/13**

**ACM/HEINE**

**XT 100/05**



**OLYMPUS**

### Bestellinformation / Ordering information

>> Bitte bestellen Sie Kaltlicht-  
grundkabel mit 2 Adaptern

>> Please order the basic fibre  
optic cable and two adapters

AA

AB

AC

AE

AK

AO

AR

KA

KS

XR

**XT**





	A	B	C	D	E	F	G
<b>A</b>							
Ä p	176						
ADSON, D ab ken	131						
ADSON, E ab ie	73						
ADSON, H tn ä lln	20						
ADSON, Pin	12						
ADSON, S go b	56						
ADSON, Wa sl p	50						
ADSON-ANDERSON, Wund p	49						
ADSON-BABY, Ä ieln me	9						
ADSON-BECKMANN, Wad p	52						
ADSON-BROWN, Pin e	12						
ADSON-MICRO, Pin n	12						
ADSON-TOENNIS-DELICATE, H tn e als b	33						
ALM, Wa sl p	48						
ALY, S iä s -Instn ente	60						
Ä b mis b Pin	12,13						
ANDERSON-ADSON, Wund p	49						
Ä me- ad Gé ässtp	109-111						
Ä nge	105-107						
Ä nge fü Anep me- Clp	112,113						
Ä s b s b	170						
Ä ieln me	9,85						
Ä aumats b Pin n	19						
AUSTIN, Kp jn	16						
<b>B</b>							
BABINSKY, Pl sionsä mme	58						
BABY-ADSON, Ä ieln me	9						
BABY-CRILE-WOOD, H tn ä ha b e U C	38						
BABY-MIXTER, P ä p ieln me	10						
BABY-OVERHOLT, H ieln me	9						
BACON, H m is sb nge	76						
BARRAQUER, Mik -Nad b e	94						
BECKMANN, Wa sl p	51						
BECKMANN-ADSON, Wad p	52						
BECKMANN-EATON, Wad p	52						
BELLUCCI, Mik -Instn e	148						
BERLINER, Pl sionsä mme	59						
BEYER, H m is sb nge	77						
BIEMER, Na ke	130						
BLUMENTHAL, H m is sb nge	75						
BÖHLER, H m is sb nge	77						
B b , H nd	62,63						
BROWN-ADSON, Pin e	12						
BUCK, Pl sionsä mme	58						
<b>C</b>							
CASPAR, Lamin mie Zange	156						
CASPAR, Mik -Instn e	3 138,143						
CASPAR, Wa sl p	119						
CASPAR, Wa sl p iä	1 6,118						
CASTROVIEJO, H tn ä ha b e U C	40						
Cljis b Pin	12,13						
CLEVELAND, H m is sb nge	74						
Clp	0 9-111						
CLOWARD mod ., Wad p	122						
CLOWARD, Lamin mie S n	156						
CLOWARD, sb f e Löff	71						
CLOWARD, iä b p p	122,124						
COLCLOUGH-KERRISON, Lamin mie S n	153						
CONE, Wa sl p	51						
CONTOUR-SCALP, Wa sl p	53						
CONVERSE, H tn ä lha b lte U C	37						
COTTLE, H mme	69						
COTTLE, Mie sse	162						
CRILE-WOOD, BABY Hartmetallnad halte U C	38						
CRILE-WOOD, H rtm allnad halte U C	38						
CRUTCHFIELD, S äde halte	100						
CUSHING, Pin e	13						
CUSHING, D rahake	131						
CUSHING, fe ne Wundhake	45						
CUSHING, H rtm allpin e te U C	20						
CUSHING, Lamin mie S an	154						
CUSHING, S inalhaken	46						
CUSHING-FERRIS-SMITH, Lamin mie Zange	157						
CUSHING-LANDOLT, S b la für p ophy e mie	162						
CUSHING-TAYLOR, H rtm allpin e te U C	20						
<b>D</b>							
DAHLGREEN, S äde a nge	99						
DAHMEN, Mie sse	68						
DAHMEN, D te tome	68						
DANDY, Ne vhake	129						
DANDY, Präparie k n me	10						
DANDY, S e e	22						
DAVIS, D ra D sse ore	132						
DE BAKEY, atraumatis b e Pinzette	19						
DE BAKEY, H rtm allnad halte U C	36						
DE VILBISS, S äde a nge	99						
DÉJERINE, Pe kussionshämmer	59						
DIETHRICH, Mik o-Pin e	90						
D ssektore , R oton-	146,147						
D ahtsäge	98						
D ra D ssektore	132-135						
D rahake	131						
<b>E</b>							
Eas lean Laminektomie Zangen	151,152						
EATON-BECKMANN, Wundspe re	52						
ECHLIN, H hlm sse a nge	79						
Einführungssonden	98						
Elevatoria	72,73						
<b>F</b>							
FAHLBUSCH, p ophy e -Instrum e	165						
FAHLBUSCH, Mik o-Instrum e	148						
FAHLBUSCH-HARDY, p ophy e -Instrum e	165						
Fasspin e	15						
Fe ne Wundhake	44,45						
FERGUSON, S ugrohre	56						
FERRIS-SMITH, Lamin mie S an	158						
FERRIS-SMITH-CUSHING, Lamin mie Zange	157						
FISCH, Ne vhake	130						
FOX-GOLDMAN, H rtm allsb e e U C	33						
FRAZIER, D ra D sse ore	133						
FRAZIER, fe ne Wundhake	44						
FRAZIER, S ugrohre	56						
FREER, Ele atorie	72						
FRIEDMAN, H hlm sse a nge	74						
FRIEDMAN-MINI, H hlm sse a nge	74						
FRYKHOLM, H hlm sse a nge	79						
<b>G</b>							
Gala hake	108						
GEMINI, Präparie k n me	10						
GILLIES, fe ne Wundhake	44						

<b>GOLDMAN-FOX</b> , ʔ t n ə l s b ʔ C	33
<b>GRAHAM</b> , D ə b k ə	131
<b>GRONINGEN</b> , N l ə k ə	129
<b>GRUENWALD-LOVE</b> , Lamink omie s n ə	154

## H

<b>HAJEK-KOFFLER</b> , Lamink mie s n ə	159
ʔ k ə g i f f e f ü D ə b ä g ə	98
<b>HALSEY</b> , ʔ t n ə l h a ʔ t t e r ʔ C	37
ʔ m m e	β 9 θ ,70
ʔ m m e, P l ə s i o n-	8 ,59
ʔ n d h ə p r ə t e	θ ,63
<b>HARDY</b> , ʔ t n ə l e-Instn e e	β 165
<b>HARDY-FAHLBUSCH</b> , ʔ t n ə l e-Instn e e	165
<b>HARMS</b> , W i l l ə p j e	125
<b>HARTMANN</b> , ʔ t n ə l s b n g ə	75
<b>HAVERFIELD-SCOVILLE</b> , W o d j e	120
<b>HEGAR-MAYO</b> , ʔ t n ə l h a ʔ t l t e ʔ C	36
<b>HEGAR-MAYO-DELICATE</b> , H a t n t e a l h a ʔ t l t e ʔ C	36
<b>HEIFETZ</b> , F a s s j n ə	15
<b>HEIFETZ</b> , H i s p t e	104
<b>HEY</b> , M ə k b j e	114
<b>HIBBS SPRATT</b> , s b f e L ö f f e	71
h i- ʔ ə b r	θ 103
H i s p t e	104
ʔ t n ə l b	178
<b>HOEN</b> , A t e t n m ə	85
<b>HOEN</b> , D a B s b e	133
<b>HOEN</b> , E t a b i e	73
ʔ t n ə l s b e	6 -68
ʔ t n ə l s b n g ə	7 -80
<b>HORSLEY</b> , N ə w b k ə	127
<b>HOSOBUCHI</b> , ʔ t n ə l e-Instn e e	167
<b>HUNT</b> , F a s s j n ə	15
ʔ t n ə l e-Instn e e	θ 167
ʔ t n ə l e- Z a n g e	161

## I

<b>INGE</b> , W i l l ə p j e	126
Instn e e , M i b -	β θ ʔ θ 149
Instn e e ʔ t n ə l f f n a g	β 99

## J

<b>JACOBSON</b> , ʔ t n ə h a ʔ t t e ʔ C	40
<b>JACOBSON</b> , M i b -Instn e e	143
<b>JACOBSON</b> , M i b -N a ʔ t t e	42
<b>JANSEN</b> , W o d j e	48
<b>JANSEN-ZAUFAL</b> , ʔ t n ə l s b n g ə	77

## K

ʔ t n ə l b	175
<b>KERRISON</b> , Lamink mie s n ə	β 159
<b>KERRISON-COLCLOUGH</b> , Lamink omie s n ə	153
<b>KILNER</b> , f e n e W a ʔ t k ə	44
K l a m m b k	107
<b>KLEINERT-KUTZ</b> , f e n e W a ʔ t k ə	44
<b>KLEINERT-KUTZ</b> , ʔ t n ə l s b n g ə	77
k n m ə	θ 8 -86
k n m ə, A t e-	9,85
k n m ə, K o p f b t u	8
k n m ə, P ä p i e -	10
K f j n ə mit P ä t u	θ , 17
K o a g a t o n s -P i n t e t , t p b r	171
<b>KOFFLER-HAJEK</b> , Lamink mie s n ə	159
<b>KOOS</b> , M i b -Instn e e	141
K o p f b t m m e	8
<b>KRAUS</b> , M i b -Instn e e	142

<b>KRAYENBÜHL</b> , N e v h a k e	130
<b>KUTZ-KLEINERT</b> , ʔ t n ə l m i e s s e a n g e	77

## L

Lamink omie-s a n ə	150-153,158-160
Lamink omie-Z a n g e	154-157
<b>LANDOLT</b> , ʔ t n ə l o p h y e -Instn e e	166
<b>LANDOLT</b> , ʔ t n ə l o p h y e -Z a n g e	161
<b>LANDOLT</b> , β r i e a n g e	162
<b>LANDOLT-CUSHING</b> , β t l a f ü r ʔ t n ə l o p h y t e o m i e	162
<b>LANDOLT-REULEN</b> , ʔ t n ə l o p h y e -Instn e e	167
<b>LANGENBECK</b> , E l e a t o r i e	72
<b>LANGENBECK</b> , ʔ t n ə l r t m e a l l n a d e h a l t e ʔ C	39
<b>LEKSELL-STILLE</b> , ʔ t n ə l m i e s s e a n g e	79
<b>LEMPERT</b> , ʔ t n ə l m i e s s e a n g e	76
<b>LEXER</b> , ʔ t n ə l r t m e a l l s b e e ʔ C	31
<b>LEXER</b> , M i e s s e	66,67
<b>LEXER</b> , θ t o t o m e	67
<b>LEXER-MINI</b> , M i e s s e	66
<b>LEYLA</b> , H r n -ʔ r a k o r	101-103
<b>LISTER</b> , ʔ t n ə l r t m e a l l s b e e ʔ C	33
L ö f f e l , s b a r f	71
<b>LOVE</b> modif., N e v w u r t h a k e n	128
<b>LOVE</b> , N e v w u r t h a k e	128
<b>LOVE-GRUENWALD</b> , Lamink omie s a n ə	154
<b>LUER</b> , ʔ t n ə l m i e s s e a n g e	75

## M

<b>MARQUARDT</b> , ʔ t n ə l m i e s s e a n g e	76
<b>MARTEL</b> , E i n f ü h r u n g s s o n d e	98
<b>MARTEL</b> , K o p f h a u t k e m m e n	8
<b>MARTIN</b> , N e v w u r t h a k e	128
<b>MATHIEU</b> , ʔ t n ə l r t m e a l l n a d e h a l t e ʔ C	39
<b>MATHIEU-DELICATE</b> , ʔ t n ə l r t m e a l l n a d e h a l t e ʔ C	39
<b>MATHIEU-RYDER-MICRO</b> , ʔ t n ə l r t m e a l l n a d e h a l t e ʔ C	39
<b>MAYFIELD</b> , ʔ t n ə l m i e s s e a n g e	76
<b>MAYO</b> , ʔ t n ə l r t m e a l l s b e e ʔ C	29
<b>MAYO-HEGAR</b> , ʔ t n ə l r t m e a l l n a d e h a l t e ʔ C	36
<b>MAYO-HEGAR-DELICATE</b> , ʔ t n ə l r t m e a l l n a d e h a l t e ʔ C	36
<b>MC KENZIE</b> , A l g ə n g e	106
<b>MC KENZIE</b> , K a m m e b l o k	107
<b>MEAD</b> , ʔ t n ə l m i e s s e a n g e	75
M e i s s e	66-68
<b>METZENBAUM</b> , ʔ t n ə l r t m e a l l s b e e ʔ C	29-32
<b>METZENBAUM-DELICATE</b> , ʔ t n ə l r t m e a l l s b e e ʔ C	31,32
<b>MEYERDING</b> , W u n d h a k e	47
<b>MICRO</b> , <b>MATHIEU-RYDER</b> , ʔ t n ə l r t m e a l l n a d e h a l t e ʔ C	39
<b>MICRO-ADSON</b> , P i n t e t e	12
<b>MICRO-MOSQUITO</b> , A t e i e k e n m e	9
<b>MICRO-RYDER</b> , ʔ t n ə l r t m e a l l n a d e h a l t e ʔ C	37
<b>MICRO-WULLSTEIN</b> , s u g r o h r e	56
M i k o -I n s t r u m e n t e	87,136-145,148-149
M i k o -N a d e l h a l t e r	41,42,94
M i k o -P i n t e t e	16-18,88-90
M i k o -S b e e n	23-28,91-93
<b>MILLES</b> , M i k o -s e e	92
<b>MILLIGAN</b> , D r a D s s e o r e	134
<b>MINI</b> , A l g ə n g e f ü r A n e r y m e -C l i p s	113
<b>MINI-FRIEDMAN</b> , ʔ t n ə l m i e s s e a n g e	74
<b>MINI-LEXER</b> , M i e s s e	66
<b>MINI-RUSKIN</b> , ʔ t n ə l m i e s s e a n g e	77
<b>MIXTER-BABY</b> , P r ä p a r i e k e n m e	10
<b>MOLDESTAD</b> , f e n e W u n d h a k e	45
<b>MOSQUITO-MICRO</b> , A t e i e k e n m e	9
M u s k e s p r e	114,115

**N**

Naß ẽ 5 2 ,94-97  
 Naß ẽ , ð tn eã l U C 36-40  
 Naß ẽ , Miß 4 ,42,94  
**NAGEL**, Miß -ß 91  
 Naß 89  
**NEIVERT**, ð tn e ha ð ẽ U C 37  
 Na ke 129,130  
 Ne Pã p ie ẽ 22  
 Na/ ke 127  
**NICOLA**, ð ð en-Instu me te 164  
**NICOLA**, Miß -Instu eẽ 149

**O**

**OKONEK**, Miß -Instu eẽ 144  
**OLDBERG**, Laminte mie Zanga 157  
**OLIVECRONA**, Ð a Ð sã e 134  
**OLIVECRONA**, ðs p ẽ 104  
**OLIVECRONA**, ð 22  
**OLIVECRONA-GIGLI**, Ð ab ägen 98  
**OLIVECRONA-TOENNIS**, Aã nge 106  
**OMBREDANNE**, ð mme 69  
 ð e b me 66,67  
**OVERHOLT-BABY**, A rienk en me 9

**P**

**PENFIELD**, Ð a Ð sã e 135  
 Pã sionsã mme 58,59  
**PETERSON-SMITH**, ð h mẽ sã nge 80  
 Pin 1 20,89-90  
 Pin, anab misb 12,13  
 Pin, at am ats ch 19  
 Pin, B-Koagã to n 171  
 Pin, ctjã ch 12,13  
 Pin, Fass- 15  
 Pin, Hatm e l U C 20  
 Pin, Knf - 16, 17  
 Pin, Miß - 18  
 Pin, Miß - 6 18,88-90  
 Pin, Nah 89  
 Pin, Um ab r- 14  
**PLATTFUSS**, Laminte mie ð nã 160  
**PLESTER**, ð go b 56  
 Pã p itã me 10, 86

**R**

**RABINER**, Pã sionsã mme 58  
**RAIMONDI**, ðn me 85  
**RALK**, ð nã h ap rã ẽ 63  
**RANEY**, Aã nge 107  
**RANEY**, Clp 107  
**RAY**, Hypo p en-Instu meẽ 163  
**REULEN-LANDOLT**, ð ð e- Instu eẽ 167  
 B b n-Ð sã e 4 6,147  
**RICHTER-SCOVILLE**, Wu d jã 121  
**RUSKIN**, ð m ẽ sã nge 7 ,78,80  
**RUSKIN-MINI**, ð m ẽ sã nge 77  
**RUSKIN-STILLE**, ð m ẽ sã nge 78  
**RYDER-MATHIEU-MICRO**, Hat mẽ aha ð lte U C 39  
**RYDER-MICRO**, ð tn e ha ð ẽ U C 37

**S**

**SACHS**, Ð a Ð sã e 133  
**SACHS**, Na/ ke 127  
**SAMII**, Fassjã 15  
**SAMII**, Miß -Instu eẽ 139

ß ugrohre 56  
**SCALP-CONTOUR**, Wundspe re 53  
 ð äde halte 100  
 ð äde a ngen 99  
 ð ere 21-34,91-93  
 ð ere , ð rtmẽ all U C 29-33  
 ð ere , Mik o 23-28,91-93  
**SCHLESINGER**, Laminte omie Zanga 155  
**SCHMIEDEN-TAYLOR**, ð e e 22  
**SCOVILLE**, A lg a nge 106  
**SCOVILLE**, Ne vwurã hake 127  
**SCOVILLE**, Wundsprẽ e 120  
**SCOVILLE-HAVERFIELD**, Wundsprẽ e 120  
**SCOVILLE-RICHTER**, Wundsprẽ e 121  
**SELVERSTONE**, Laminte omie Zanga 155  
**SEMB**, ð hlmẽ sã nge 78  
 ð sibilitãts-Instrumente 60  
**SMITH-FERRIS**, Laminte omie ð anã 158  
**SMITH-FERRIS-CUSHING**, Laminte omie Zanga 157  
**SMITH-PETERSON**, ð hlmẽ sã nge 80  
**SMITHWICK**, Ne vhake 129  
**SNITMAN**, Wundspe re 48  
 ð ekula für Hp ophy ẽ omie 162  
**SPINAL FUSION**, sb arfe Löffẽ 71  
 ð inalhake 46  
 ð rã nge für Hp ophy ẽ omie 162  
**SPURLING**, Laminte omie ð anã 154  
**STANDARD**, A lg a nge für Anã ry me -Clips 113  
**STANDARD**, ð rtmẽ allsb e e U C 29  
 ð anã , Laminte omie 150-153,159-160  
**STELLBRINK**, ð hlmẽ sã nge 74  
**STILLE**, ð ndbohrapparate 62  
**STILLE**, ð hlmẽ sã nge 78  
**STILLE-LEKSELL**, ð hlmẽ sã nge 79  
**STILLE-RUSKIN**, ð hlmẽ sã nge 78  
**STRULLY**, ð e e 22

**T**

**TAYLOR**, Pe kussionshãmmẽ 58  
**TAYLOR**, ð inalhaken 46  
**TAYLOR**, Wundsprẽ e 120  
**TAYLOR-CUSHING**, ð rtmẽ allpinẽ te U C 20  
**TAYLOR-SCHMIEDEN**, ð e e 22  
**TOENNIS-ADSON-DELICATE**, ð rtmẽ allsb e e U C 33  
**TOENNIS-OLIVECRONA**, A lg a nge 106  
**TÖNNIS**, Ð ra D sã ore 132  
**TROEMNER**, Pe kussionshãmmẽ 59

**U**

Uhrmab erpinẽ tten 14  
**UNIVERSAL**, ð rtmẽ allsb e e U C 33  
**UNIVERSAL**, ð hlmẽ sã nge 74

**V**

**VANNAS**, Mik o-ß e e 92  
**WISE**, K üpfpinẽ te mit Plate u 16

**W**

**WARTENBERG**, ð sibilitãts-Instrumẽ te 60  
**WEITLANER**, Wundspe re 49  
**WILLET-MARTEL**, Kopfhautk emmen 8  
 Wirbẽ körpe sprẽ e r 124-126  
**WOOD-CRILE**, **BABY** Hartmetallnadẽ halte U C 38  
**WOOD-CRILE**, ð rtmẽ allnadẽ halte U C 38  
**WULLSTEIN-MICRO**, ð ugrohre 56  
 Wundhake 43-54  
 Wundhake , fe n 44,45

Wod p re, sb b b d	8 -53
Wod sp	6 123
Wod sp ä	6 118

## Z

Zange, Lamin	5 157
<b>ZAUFAL-JANSEN</b> , El m is sb nge	77



	Page		Page
<b>A</b>			
Á þ	176	Connè ion o rds	170
ADSON, íð stng fop tungsta U C	20	<b>CONVERSE</b> , nd le holde s tungsta U C	37
ADSON, el sing fop	12	<b>COTTLE</b> , b isè s	162
ADSON, d a b ok	131	<b>COTTLE</b> , malle s	69
ADSON, e ab s	73	Cranial rongeurs	99
ADSON, e ab s	50	<b>CRILE-WOOD</b> , nd le holde s tungsta U C	38
ADSON, sto n tu b	56	<b>CRILE-WOOD-BABY</b> , nd le holde s tungsta U C	38
ADSON-ANDERSON, e rab s	49	<b>CRUTCHFIELD</b> , e via l trat ion tongs	100
ADSON-BABY, ap fop	9	<b>CUSHING</b> , de ia te hook	45
ADSON-BECKMANN, e t ab s	52	<b>CUSHING</b> , disse ing fop s tungsta U C	20
ADSON-BROWN, el sing fop	12	<b>CUSHING</b> , dra sing fop s	13
ALM, e ab s	48	<b>CUSHING</b> , dura hook	131
ALY, sas itty instn ents	60	<b>CUSHING</b> , laminè omy punb e	154
ANDERSON-ADSON, e rab s	49	<b>CUSHING</b> , spinal rø rat ors	46
Ap m- and e sè lð	109-111	<b>CUSHING</b> , tissue fop s	13
Þng fop	105-107	<b>CUSHING-LANDOLT</b> , spe la for hþ ophy e omy	162
Þng fop for ang m lð	112,113	<b>CUSHING-TAYLOR</b> , disse ing fop s tungsta U C	20
Þ fop	9,85	<b>D</b>	
AUSTIN, sè þng fop ið þ f om	16	<b>DAHLGREEN</b> , c anial rongø rs	99
<b>B</b>			
BABINSKY, þ sion l a mme s	58	<b>DAHMEN</b> , b isè s	68
BABY-ADSON, ap fop	9	<b>DAHMEN</b> , oste tomè	68
BABY-CRILE-WOOD, nd b el tgs te U C	38	<b>DANDY</b> , disse ing fop s	10
BABY-MIXTER, íð stng fop	10	<b>DANDY</b> , ne ve hook	129
BABY-OVERHOLT, ap fop s	9	<b>DANDY</b> , sè ssors	22
BACON, b ne o ngæ	76	<b>DAVIS</b> , dura disse ors	132
BARRAQUER, mio ne el b el s	94	<b>DE BAKEY</b> , nd le holde s tungsta U C	36
BECKMANN, e ab s	51	<b>DE BAKEY</b> , non-traumatic fop s	19
BECKMANN-ADSON, e t ab s	52	<b>DE VILBISS</b> , c anial rongø rs	99
BECKMANN-EATON, e ab s	52	<b>DÉJERINE</b> , pe a ssion hamme s	59
BELLUCCI, mio inst m et	148	Ð ia te hooks	44,45
BERLINER, þ sion l a mmers	59	<b>DIETHRICH</b> , mic o fop s	90
BEYER, b ne o ngæ	77	D sè omy rø rat ors	114,115
BIEMER, ne b ok	130	D sset ing fop s	10,86
BLUMENTHAL, b ne o ngæ	75	D sset ing fop s tungsten U C	20
BÖHLER, b ne o ngæ	77	D essing fore ps	12,13
B ne ð	71	D ra disse ors	132-135
B ne o ngæ	74-80	D ra hooks	131
B ain e ab r	0 1-103	<b>E</b>	
B ain sp ð s	104	Easç lean laminè omy rongeurs	151,152
BROWN-ADSON, el sing fop	12	<b>EATON-BECKMANN</b> , rø rat ors	52
BUCK, þ sion l a mme s	58	<b>ECHLIN</b> , bone rongø rs	79
<b>C</b>			
CASPAR, ið l e t ab s	1 6,118	Elevators	72,73
CASPAR, l a minè my o ngeurs	156	<b>F</b>	
CASPAR, mio inst m et	3 138,143	<b>FAHLBUSCH</b> , mic o instrumø ts	148
CASPAR, e ab s	119	<b>FAHLBUSCH</b> , pituitary instrumø ts	165
CASTROVIEJO, nd b el tgs te U C	40	<b>FERGUSSON</b> , sut ion tube	56
Cia l e ab s	116-118	<b>FERRIS-SMITH</b> , laminè omy punb e	158
Cia l t ab n b ngs	100	<b>FERRIS-SMITH-CUSHING</b> , laminè omy rongø rs	157
Cis b	66-68	Fibre optic a ble	175
CLEVELAND, b ne o ngæ	74	<b>FISCH</b> , ne ve hook	130
Clp a ie	107	Fop s	11-20,89-90
Clp	0 109-111	Fop s, apply ng	105-107
CLOWARD, b ne ð	71	Fop s, arte y	9,85
CLOWARD, l a mina sp el	122,124	Fop s, B -o agulation	171
CLOWARD, l a minè my o ngæ	156	Fop s, disse ing	10,86
CLOWARD modf ., e t at ors	122	Fop s, disse ing tungsta U C	20
Coagla to n fop , lð l a r	171	Fop s, dra sing	12,13
Contd s for ið savv	98	Fop s, grasping	15
CONE, e ab s	51	Fop s, Jæ l e e 's	14
		Fop s, mic o	16-18,88-90
		Fop s, non-traumatic	19

Forceps, scalp flap	8
Fop , suta	89
Fop , suta ŋg	6 ,17
Fop , tu ngstæ U C	20
FRAZIER, hæ e b ok	44
FRAZIER, d a ð sè s	133
FRAZIER, stö n tu b	56
FREER, hæ ab s	72
FRIEDMAN, b ne o ngæ	74
FRIEDMAN-MINI, b ne o ngæ	74
FRYKHOLM, b ne o ngæ	79

## G

Gab b oks	108
GEMINI, ð sŋg fop	10
GILLIES, hæ e b ok	44
GOLDMAN-FOX, sis sos tu ngstæ U C	33
Gogæ	6 -68
GRAHAM, d a b ok	131
Grasping fop	15
GRONINGEN, næ b ok	129

## H

HAJEK-KOFFLER, hæ minæ my pb æ	159
HALSEY, nð b ð tu gstæ U C	37
hæ mmæ , p sion	8 ,59
hæ nd ð	8 ,63
hæ nð for iæ sæs	98
HARDY, þæ y instn æs	β 165
HARDY-FAHLBUSCH, þæ y instn æs	165
HARMS, hæ mina sp æ ð	125
HARTMANN, b ne o ngæ	75
HEIFETZ, bæ in sp tæ s	104
HEIFETZ, grasŋg fop	15
HEY, ð è my æ ab s	114
HIBBS SPRATT, bæ ne hæ	71
hðh fæy o d	178
HOEN, ap foc p	85
HOEN, d a ð sè s	133
HOEN, hæ ab s	73
h ok , d a	131
h ok , næ	9 ,13
HORSLEY, næ o ot æ ab s	127
HOSOBUCHI, þæ y instn æs	167
HUNT, grasŋg fop	15

## I

INGE, hæ mina sp æ ð	126
Instn æs for c anial oping	β 99

## J

JACOBSON, mio -nð b ð	42
JACOBSON, mio instn æs	143
JACOBSON, nð b ð tgs hæ U C	40
JANSEN, hæ ab s	48
JANSEN-ZAUFAL, b ne o ngæ	77
Jæv s fop	14

## K

KERRISON, hæ minæ my pb æ	β 159
KERRISON-COLCLOUGH, hæ minæ omy pb æ	153
KILNER, hæ e b ok	44
KLEINERT-KUTZ, b ne o ngæ	77
KLEINERT-KUTZ, hæ e b ok	44
KOOS, mio instn æs	141
KRAUS, mio instn æs	142

KRAYENBÜHL, næ ve hook	130
------------------------	-----

## L

Lamina spræ ders	124-126
Laminæ omy punb es	150-153,158-160
Laminæ omy rongeurs	154-157
LANDOLT, pituitary instrumæ ts	166
LANDOLT, pituitary rongæ rs	161
LANDOLT, spræ de	162
LANDOLT-REULEN, pituitary instrumæ ts	167
LANGENBECK, hæ æ ators	72
LANGENBECK, nð le holde s tungstæ U C	39
LEMPERT, bone rongæ rs	76
LEXER, hæ isè s	66,67
LEXER, ostæ tomæ	67
LEXER, sic ssors tungstæ U C	31
LEXER-MINI, hæ isè s	66
LEYLA, brain ræ rat or	101-103
LOVE-GRUENWALD, laminæ omy punb æ	154
LOVE, næ ve root ræ rat ors	128
LOVE modif., næ ve root retrat ors	128
LUER, bone rongæ rs	75

## M

Mallets	58,59,69,70
MARQUARDT, bone rongæ rs	76
MARTEL, o ndut ors for wire saws	98
MARTEL, scalp flap forceps	8
MARTIN, næ ve root ræ rat ors	128
MATHIEU, nð le holde s tungstæ U C	39
MATHIEU-DELICATE, nð le holde s tungstæ U C	39
MATHIEU-RYDER-MICRO, nð le holde s tungstæ U C	39
MAYFIELD, bone rongæ rs	76
MAYO, sic ssors tungstæ U C	29
MAYO-HEGAR, nð le holde s tungstæ U C	36
MAYO-HEGAR-DELICATE, nð le holde s tungstæ U C	36
MC KENZIE, apply ng fop s	106
MC KENZIE, k ip æ rrie	107
MEAD, bone rongæ rs	75
METZENBAUM, sic ssors tungstæ U C	29-32
METZENBAUM-DELICATE, sic ssors tungstæ U C	31,32
MEYERDING, ræ rat ors	47
MICRO-ADSON, dre sing fop s	12
MICRO-MOSQUITO, arte y fop s	9
MICRO-RYDER, nð le holde s tungstæ U C	37
Mic o fore ps	16-18,88-90
Mic o instruments	87,136-145,148,149
Mic o nð le holders	41,42,94
Mic o sic ssors	23-28,91-93
MILLES, mic o sic ssors	92
MILLIGAN, dura disse ors	134
MINI, apply ng fop s for anæ ry m k ips	113
MINI-FRIEDMAN, bone rongæ rs	74
MINI-LEXER, hæ isè s	66
MINI-RUSKIN, bone rongæ rs	77
MIXTER-BABY, disse ing fop s	10
MOLDESTAD, de ia te hook	45

## N

NAGEL, mic o sic ssors	91
Needle holde s	35-42,94-97
Needle holde s, mic o	41,42,94
Needle holde s, tungstæ U C	36-40
NEIVERT, nð le holde s tungstæ U C	37
Nerve disse ing sic ssors	22
Nerve hooks	129,130
Nerve root ræ rat ors	127
NICOLA, mic o instrumæ ts	149

	Page		Page
<b>NICOLA</b> , <i>hæ y instn æ ts</i>	164	<b>STELLBRINK</b> , bone rongæ rs	74
Non-t am atc ts sæ foe ps	19	<b>STILLE</b> , bone rongæ rs	78
<b>O</b>		<b>STILLE</b> , hand drills	62
<b>OKONEK-YASARGIL</b> , mio instn æts	144	<b>STILLE-RUSKIN</b> , bone rongæ rs	78
<b>OLDBERG</b> , hæ minæ my o ngeurs	157	<b>STRULLY</b> , sct ssors	22
<b>OLIVECRONA</b> , bæ ain sp tɪ las	104	ʃ t ion tubes	56
<b>OLIVECRONA</b> , d a ts sê ors	134	ʃ ture fore ps	89
<b>OLIVECRONA</b> , sct sos	22	ʃ ture tɪ ng forp s with platform	16,17
<b>OLIVECRONA-GIGLI</b> , iw e saws	98	<b>T</b>	
<b>OLIVECRONA-TOENNIS</b> , ap y ng forp	106	<b>TAYLOR</b> , pæ a ssion hamme s	58
<b>OMBREDANNE</b> , maæ	69	<b>TAYLOR</b> , ræ rat ors	120
ð æ b me	66,67	<b>TAYLOR</b> , spinal ræ rat ors	46
<b>OVERHOLT-BABY</b> , apæ forp	9	<b>TOENNIS-ADSON-DELICATE</b> , sct ssors tungstæ U C	33
<b>P</b>		<b>TÖNNIS</b> , dura disse ors	132
<b>PENFIELD</b> , d a ts sê s	135	<b>TROEMNER</b> , pæ a ssion hamme s	59
Pæ sion hæ mme	58,59	Tubes, sut ion	56
Pitæ y instn æts	6 1-167	<b>U</b>	
Pitæ y o ngæ	161	<b>UNIVERSAL</b> , bone rongæ rs	74
<b>PLATTFUSS</b> , hæ minæ my pb æ	160	<b>UNIVERSAL</b> , sct ssors tungstæ U C	33
<b>PLESTER</b> , stæ n tɪ bæ	56	<b>V</b>	
<b>R</b>		<b>VANNAS</b> , mic o sct ssors	92
<b>RABINER</b> , pæ sion hæ mme s	58	Væ sê - and anæ ry m tɪ ps	109-111
<b>RAIMONDI</b> , apæ forp	85	<b>W</b>	
<b>RALK</b> , hæ nd ts	63	<b>WARTENBERG</b> , sæ sibility instrumæ ts	60
<b>RANEY</b> , apng forp	107	<b>WEITLANER</b> , ræ rat ors	49
<b>RANEY</b> , tæ	107	<b>WILLET-MARTEL</b> , scalp flap forceps	8
<b>RAY</b> , piti iæ y instn æ ts	163	Wire saws	98
Ræ ab s	43-54	<b>WULLSTEIN-MICRO</b> , sut ion tube	56
Ræ ab s	1 6-123	<b>Z</b>	
Ræ ab s, æ l	1 6-118	<b>ZAUFAL-JANSEN</b> , bone rongæ rs	77
Ræ ab s, sê æ ining	48-53		
<b>RUSKIN</b> , bæ ne o ngæ	7 ,78,80		
<b>RUSKIN-MINI</b> , bæ ne o ngæ	77		
<b>S</b>			
<b>SACHS</b> , d a ts sê s	133		
<b>SACHS</b> , næ o ot æ at ors	127		
<b>SAMII</b> , grasng forp	15		
<b>SAMII</b> , mio instn æts	139		
<b>SCALP-CONTOUR</b> , æ ab s	53		
Scalp flap forceps	8		
<b>SCHLESINGER</b> , hæ minæ my o ngæ rs	155		
<b>SCHMIEDEN-TAYLOR</b> , sct sos	22		
ʃ s sos	2 34,91-93		
ʃ s sos, mio	2 28,91-93		
ʃ s sos, tgs bæ U C	29-33		
<b>SCOVILLE</b> , næ o ot æ ab s	127		
<b>SCOVILLE</b> , æ ab s	120		
<b>SCOVILLE-HAVERFIELD</b> , æ ab s	120		
<b>SCOVILLE-RICHTER</b> , æ ab s	121		
ʃ bæ ining æ at os	48-53		
<b>SELVERSTONE</b> , hæ minæ my o ngæ	155		
<b>SEMB</b> , bæ ne o ngæ	78		
ʃ s ity instn æts	60		
<b>SMITH-PETERSON</b> , bæ ne rongæ	80		
<b>SMITHWICK</b> , næ b ok	129		
<b>SNITMAN</b> , æ ab s	48		
ʃ forp ʃ bæ my	162		
<b>SPINAL FUSION</b> , bæ ne a ræ	71		
ʃnæ l æ ab s	46		
ʃ æ l forp ʃ bæ my	162		
<b>SPURLING</b> , hæ minæ my pb æ	154		
<b>STANDARD</b> , apng forp for anæ ry m tɪ ps	113		
<b>STANDARD</b> , sct sos tɪ ngstæ U C	29		



	Página		Página
<b>A</b>			
Á p d r	176		
ADSON, e ad e	73		
ADSON, ganb s para d a-madre	131		
ADSON, jna s el í ð n	12		
ADSON, jna s el í ð n tungstæ o U C	20		
ADSON, sp rad e	50		
ADSON, b s el aspr aión	56		
ADSON-BROWN, jna s de í ð n	12		
ALM, sp rad e	48		
ALY, instn e b s sæs íð idad	60		
ANDERSON-ADSON, sp arad e	49		
AUSTIN, jna s el lga d a o n plataforma	16		
<b>B</b>			
BABINSKY, matb s de p íón	58		
BABY-ADSON, jna s ðn osá ta s	9		
BABY-CRILE-WOOD, p ð -agj s tugs ðo U C	38		
BABY-MIXTER, jna s p ra p raí one	10		
BABY-OVERHOLT, jna s ðn ostátia s	9		
BACON, jna s-gla s	76		
BARRAQUER, mio -p t a-agj s	94		
BECKMANN, sp rad e	51		
BECKMANN-ADSON, sep rad e	52		
BECKMANN-EATON, sp rad e	52		
BELLUCCI, instn e b s p ra mio ígá	148		
BERLINER, matb s de p íón	59		
BEYER, jna s-gb ias	77		
BIEMER, ganb s para nið s	130		
BLUMENTHAL, jna s-gula s	75		
BÖHLER, jna s-gb ias	77		
BUCK, matb s de p íón	58		
<b>C</b>			
Cab el o næ ion	170		
Cables fibra óptica	175		
CASPAR, instn e b s p ra mio ígá	3 138,143		
CASPAR, jna s o rð nð p ra ða minð má	156		
CASPAR, sp rad e	119		
CASPAR, sp rad e b rað	1 6,118		
CASTROVIEJO, p ð -agj s tugs ðo U C	40		
Cinè	66-68		
CLEVELAND, jna s-gb ias	74		
Clp	p 0 9-111		
Clp el anæ ma	109-111		
CLOWARD, ð íð s o ða nð	71		
CLOWARD, jna s o ða nð p ra laminè omía	156		
CLOWARD, sp rad e p ra ð e pos ve tð rale	2 2,124		
CLOWARD moif ., sep radore	122		
CONE, sp rad e	51		
CONVERSE, p ð -agj s tugs ta o U C	37		
COTTLE, inè	162		
COTTLE, matb s	69		
CRILE-WOOD, p ð -agujas tungstæ o U C	38		
CRUTCHFIELD, jna s el t aít ón c anial	100		
Cl ð íð s o ða nð	71		
CUSHING, ganb s	45		
CUSHING, ganb s para d a-madre	131		
CUSHING, jna s o rð nð p ra ða minð mia	154		
CUSHING, jna s el í ð n	13		
CUSHING, jna s el í ð n tungstæ o U C	20		
CUSHING, sp rad e e jna ès	46		
CUSHING-LANDOLT, espéculos para hipófisis	162		
CUSHING-TAYLOR, jna s de í ð n tungstæ o U C	20		
<b>D</b>			
DAHLGREEN, pina s c anial	99		
DAHMEN, í nð e	68		
DAHMEN, oste tomè	68		
DANDY, ganb os para nervios	129		
DANDY, pina s para prp arac ones	10		
DANDY, tije as	22		
DAVIS, dise dorè para dura-madre	132		
DE BAKEY, pina s atrauma	19		
DE BAKEY, porta-agujas tungstæ o U C	36		
DE VILBISS, pina s c anial	99		
DÉJERINE, martillos de pe a sión	59		
DIETHRICH, mic o-pina s	90		
D se dores para dura-madre	132-135		
<b>E</b>			
Easç lean pina s o rtantes para diso s inte ve tð rales	151,152		
ECHLIN, pina s-gubias	79		
Elevadore	72,73		
Espátulas e rð rale	104		
Espéculos para hipófisis	162		
<b>F</b>			
FAHLBUSCH, instrumentos para hipófisis	165		
FAHLBUSCH, instrumè tos para mic oç rugía	148		
FERGUSSON, tubos de aspirac ón	56		
FERRIS-SMITH, pina s o rtantè para diso s inte ve tð rales	158		
FERRIS-SMITH-CUSHING, pina s o rtantè para laminè omía	157		
FISCH, ganb os para nervios	130		
FRAZIER, dise dorè para dura-madre	133		
FRAZIER, ganb os	44		
FRAZIER, tubos de aspirac ón	56		
FREER, e e adore	72		
FRIEDMAN, pina s-gubias	74		
FRIEDMAN-MINI, pina s-gubias	74		
FRYKHOLM, pina s-gubias	79		
<b>G</b>			
Ganb os	44,45		
Ganb os para dura-madre	131		
Ganb os para gale	108		
Ganb os para ne vios	129,130		
GEMINI, pina s para prp arac ones	10		
GILLIES, ganb os	44		
GOLDMAN-FOX, tije as tungstæ o U C	33		
GRAHAM, ganb os para dura-madre	131		
GRONINGEN, ganb os para nervios	129		
Gubias	66-68		
<b>H</b>			
HAJEK-KOFFLER, pina s o rtantè para diso s intervertebrales	159		
HALSEY, porta-agujas tungstæ o U C	37		
HARDY, instrumentos para hipófisis	163,165		
HARDY-FAHLBUSCH, instrumentos para hipófisis	165		
HARMS, sp aradore para cue pos ve tð rales	125		
HARTMANN, pina s-gubias	75		
HEIFETZ, e pátulas e rð rale	104		
HEIFETZ, pina s para o ge	15		
HEY, sp aradore para músu los	114		
HIBBS SPRATT, a b arillas o rtantè	71		
HOEN, dise dorè para dura-madre	133		
HOEN, e e adore	73		

**HOEN**, jna s ñ osá ta s 85  
**HORSLEY**, sp rad e d raiz d ne vios 127  
**HOSOBUCHI**, instrumentos para hipófisis 167  
**HUNT**, jna s p ra o ge 15

**I**

**INGE**, sp rad e p ra e p os ve tã rale 126  
 Instn eb s p ra ab a c a n e n a ß 99  
 Instrumentos para hipófisis 6 167  
 Instn eb s p ra mio tã á 3 3 3 149  
 Instn eb s s e s i l l e d 60

**J**

**JACOBSON**, instn eb s p ra mic o t rugía 143  
**JACOBSON**, mio -p ã -agjã s 42  
**JACOBSON**, p ã -agjã s tã g s tã o U C 40  
**JANSEN**, sp rad e 48

**K**

**KERRISON**, jna s o ã n e para diso s inte ve tã ab 3 159  
**KERRISON-COLCLOUGH**, jn a s para ã o s inte ve tã rã b 153  
**KILNER**, ganb s 44  
**KLEINERT-KUTZ**, ganb s 44  
**KLEINERT-KUTZ**, jna s-gb ias 77  
**KOOS**, instn e b s p ra mio tã á 141  
**KRAUS**, instn eb s p ra micro t rugía 142  
**KRAYENBÜHL**, ganb s para n i o s 130

**L**

**LANDOLT**, instrumentos para hipófisis 166  
**LANDOLT**, pinzas cortantes para hipófisis 161  
**LANDOLT**, separador para hipófisis 162  
**LANDOLT-REULEN**, instrumentos para hipófisis 167  
**LANGENBECK**, e ad e 72  
**LANGENBECK**, p ã -aguã s tã g s tã o U C 39  
**LEMPERT**, jna s-gã s 76  
**LEXER**, in e 6 ,67  
**LEXER**, os e b mes 67  
**LEXER**, tã as tã g s tã o U C 31  
**LEXER-MINI**, in e 66  
**LEYLA**, sp rad e b a b 0 103  
**LOVE-GRUENWALD**, jna s para ã o s in e ve tã rã b 154  
**LOVE**, sp rad e d raiz d n i o s 128  
**LOVE** moif ., sp rad e d raiz d n i o s 128  
**LUER**, jna s-gb ias 75

**M**

Mango maiz 98  
**MARQUARDT**, jna s-gb ias 76  
**MARTEL**, jna s p ra jã ne 8  
**MARTEL**, sond o n d ra 98  
 Matb s 3 9 0 ,70  
 Matb s d p i ó n 8 ,59  
**MARTIN**, sp rad e d raiz de ne vios 128  
**MATHIEU**, p ã -aguã s tã g s tã o U C 39  
**MATHIEU-DELICATE**, p ã -agjã s tã g s tã o U C 39  
**MATHIEU-RYDER-MICRO**, p ã -agjã s tã g s tã o U C 39  
**MAYFIELD**, jna s-gb ias 76  
**MAYO**, tã as tã g s tã o U C 29  
**MAYO-HEGAR**, p ã -aguã s tã g s tã o U C 36  
**MAYO-HEGAR-DELICATE**, p ã -agjã s tã g s tã o U C 36  
**MC KENZIE**, jna s a p i e d ras 106  
**MC KENZIE**, sop e d grã p s 107  
**MEAD**, jna s-gb ias 75  
**METZENBAUM**, tã as tã g s tã o U C 9 32  
**METZENBAUM-DELICATE**, tã as tã g s tã o U C 3 32

**MEYERDING**, sp aradore 47  
**MICRO-ADSON**, pina s de dis e ó n 12  
**MICRO-MOSQUITO**, pina s h e n o s tã t i e s 9  
 Mic o-pina s 16-18,88-90  
 Mic o-porta-agujas 41,42,94  
**MICRO-RYDER**, porta-agujas tungstã o U C 37  
 Mic o-tije as 23-28,91-93  
**MILLES**, mic o-tije as 92  
**MILLIGAN**, dis e d o r e para dura-madre 134  
**MINI**, pina s para juntar tã ips de aneurisma 113  
**MINI-FRIEDMAN**, pina s-gubias 74  
**MINI-LEXER**, i n e 66  
**MINI-RUSKIN**, pina s-gubias 77  
**MOLDESTAD**, ganb os 45

**N**

**NAGEL**, mic o-tije as 91  
**NEIVERT**, porta-agujas tungstã o U C 37  
**NICOLA**, instrumentos para hipófisis 164  
**NICOLA**, instrum e tos para mic o t rugía 149

**O**

**OKONEK**, instrum e tos para mic o t rugía 144  
**OLDBERG**, pina s o r tã n t e para lamin e omía 157  
**OLIVECRONA**, dis e d o r e para dura-madre 134  
**OLIVECRONA**, e pã tulas e b rale 104  
**OLIVECRONA**, tije as 22  
**OLIVECRONA-GIGLI**, sie ras de hilos 98  
**OLIVECRONA-TOENNIS**, pina s a p i e doras 106  
**OMBREDANNE**, martillos 69  
 O t e tomes 66,67

**P**

**PENFIELD**, dis e d o r e para dura-madre 135  
 Pe foradore de mano 62,63  
 Pina s 11-20-,89,90  
 Pina s a p i e doras 105-107  
 Pina s atrauma 19  
 Pina s o r tã n t e para diso s inte ve tã rã b 150-153,158-160  
 Pinzas cortantes para hipófisis 161  
 Pina s o r tã n t e para lamin e omía 154-157  
 Pina s c a n i a l 99  
 Pina s de ligadura o n plataforma 16,17  
 Pina s de r e o j e r o 14  
 Pina s de tra e ó n c a n i a l 100  
 Pina s-gubias 74-80  
 Pina s h e n o s tã t i e s 9,85  
 Pina s h e n o s tã t i e s para pe i c á n e 8  
 Pina s mic o 16-18,88-90  
 Pina s para o ge 15  
 Pina s para juntar tã ips de a n e r i s m a 112,113  
 Pina s para la B -Coagula e ó n 171  
 Pina s para p r e a r a e o n e 10,86  
 Pina s para sutura 89  
 Pina s, tungsteno U C 20  
**PLATTFUSS**, pina s o r tã n t e para diso s intervertebrale 160  
**PLESTER**, tubos de aspira e ó n 56  
 Porta-agujas 36-42,94-97  
 Porta-agujas, mic o 41,42,94  
 Porta-agujas, tungstã o U C 36-40

**R**

**RABINER**, martillos de pe a s i ó n 58  
**RAIMONDI**, pina s h e n o s tã t i e s 85  
**RALK**, pe foradore de mano 63  
**RANEY**, tã ips 107  
**RANEY**, pina s a p i e doras 107



<b>RAY</b> , instrumentos para hipófisis	163
<b>RUSKIN</b> , pinas-gubias	7, 78, 80
<b>RUSKIN-MINI</b> , pinas-gubias	77

## S

<b>SACHS</b> , diseño de para dura-mad	133
<b>SACHS</b> , separador de raíz de dientes	127
<b>SAMII</b> , instrumento de separación mio	139
<b>SAMII</b> , pinas para oge	15
<b>SCALP-CONTOUR</b> , separador	53
<b>SCHLESINGER</b> , pinas para lámina má	155
<b>SCHMIEDEN-TAYLOR</b> , tijeras	22
<b>SCOVILLE</b> , separador	106
<b>SCOVILLE</b> , separador de raíz de dientes	127
<b>SCOVILLE-HAVERFIELD</b> , separador	120
<b>SCOVILLE-RICHTER</b> , separador	121
<b>SELVERSTONE</b> , pinas para lámina omía	155
<b>SEMB</b> , pinas-gubias	78
Separadores para hipófisis	4, 5, 14-128
Separadores para hipófisis	48-53
Separadores para hipófisis	0, 1-103
Separadores para hipófisis	2, 7, 128
Separadores para hipófisis	46
Separadores para hipófisis	124-126
Separadores para hipófisis	162
Separadores para hipófisis	1, 4, 115
Separadores para hipófisis	1, 6-118
Tijeras de mano	98
<b>SMITH-PETERSON</b> , pinas-gubias	80
<b>SMITHWICK</b> , gancho para dientes	129
<b>SNITMAN</b> , separador	48
Separadores para hipófisis	98
Separadores para hipófisis	107
<b>SPINAL FUSION</b> , tornillos para columna	71
<b>SPURLING</b> , pinas para dientes de incisivos	154
<b>STANDARD</b> , pinas para tijeras de ángulo	113
<b>STANDARD</b> , tijeras de tgs tipo U C	29
<b>STELLBRINK</b> , pinas-gubias	74
<b>STILLE</b> , separador de mano	62
<b>STILLE</b> , pinas-gubias	78
<b>STILLE-RUSKIN</b> , pinas-gubias	78
<b>STRULLY</b> , tijeras	22

## T

<b>TAYLOR</b> , matas de para	58
<b>TAYLOR</b> , separador	120
<b>TAYLOR</b> , separador de pinas	46
Tijeras	2, 34, 91-93
Tijeras mio	2, 28, 91-93
Tijeras para dientes	22
Tijeras, tgs tipo U C	29-33
<b>TOENNIS-ADSON-DELICATE</b> , tijeras de tgs tipo U C	33
<b>TÖNNIS</b> , diseño de separador de madre	132
<b>TROEMNER</b> , matas de para	59
Tubos de aspiración	56

## U

<b>UNIVERSAL</b> , pinas-gubias	74
<b>UNIVERSAL</b> , tijeras de tgs tipo U C	33

## V

<b>VANNAS</b> , mio-tijeras	92
-----------------------------	----

## W

<b>WARTENBERG</b> , instrumentos de sibilidad	60
<b>WEITLANER</b> , separador	49
<b>WILLET-MARTEL</b> , pinas para peicáneo	8
<b>WULLSTEIN-MICRO</b> , tubos de aspiración	56

## Z

<b>ZAUFAL-JANSEN</b> , pinas-gubias	77
-------------------------------------	----



	Page		Page
<b>A</b>			
ADSON, a n b d asj r ato n	56	Crochets très fins	44,45
ADSON, o b à d mère	131	CRUTCHFIELD, pine de trat ion c ânie ne	100
ADSON, é b	50	Curettes tranb ante	71
ADSON, é ab	73	CUSHING, c ob è s à dure mè e	131
ADSON, jne à disst n	12	CUSHING, crochets très fins	45
ADSON, jne à disst n tungstà e U C	20	CUSHING, é rtè rs spinals	46
ADSON-BROWN, jne à disst n	12	CUSHING, pine à disst ion	13
ALM, é b	48	CUSHING, pine à disst ion tungstà e U C	20
ALY, instn e s sè s ibilt é	60	CUSHING, pine pour lame inte ve t b rales	154
ANDERSON-ADSON, é rtè rs	49	CUSHING-LANDOLT, spé lums pour la b irurgie pituitaire	162
AUSTIN, jne à lga b ae p è fom e	16	CUSHING-TAYLOR, pine à disst ion tungstà e U C	20
<b>B</b>			
BABINSKY, ma b x -p rs	58	<b>D</b>	
BABY-ADSON, jne én osà b	9	DAHLGREEN, pine pour c âne	99
BABY-CRILE-WOOD, p è aigilè tgs à e U C	38	DAHMEN, ç sa ux-burins	68
BABY-MIXTER, jne à è st n	10	DAHMEN, osté tome	68
BABY-OVERHOLT, jne hén ostatique	9	DANDY, ç sa ux	22
BACON, jne -goge	76	DANDY, c ob è s à ne fs	129
BARRAQUER, mio -p t e aigilè	94	DANDY, pine à disst ion	10
BECKMANN, é b	51	DAVIS, disst e rs à dure mè e	132
BECKMANN-ADSON, é at e rs	52	DE BAKEY, pine atrauma	19
BECKMANN-EATON, é b	52	DE BAKEY, porte aiguille tungstà e U C	36
BELLUCCI, instn e s p u à b irurgie mic o	148	DE VILBISS, pine pour c âne	99
BERLINER, ma b x -p s	59	DÉJERINE, marta ux-pe o t è rs	59
BEYER, jne -goge	77	DIETHRICH, mic o-pine	90
BIEMER, o b à né s	130	D sset e rs à dure mè e	132-135
BLUMENTHAL, jne -goge	75	<b>E</b>	
BÖHLER, jne -goge	77	Easç lean pine en porte pièe s à laminet omie	151,152
BUCK, ma b x -p rs	58	Éa rtè rs	44-53,114-128
<b>C</b>			
Câb d rao èt	170	Éa rtè rs autostatiques	48-53
Câbles fibre optique	175	Éa rtè rs é ébrale	101-103
Can b d asj r ato n	56	Éa rtè rs e via le	116-118
CASPAR, é b	119	Éa rtè rs muso laire	114,115
CASPAR, é b cè b	1 6,118	Éa rtè rs pour o rps vertébraux	124-126
CASPAR, instn e s p u à b irurgie mic o	3 138,143	Éa rtè rs pour la b irurgie pituitaire	162
CASPAR, jne en p è jè e à laminet omie	156	Éa rtè rs spinals	46
CASTROVIEJO, p è aigilè tgs èe U C	40	ECHLIN, pine -goge	79
Cise x	2 34,91-93	Élévate rs	72,73
Cise x -bns	66-68	<b>F</b>	
Cise x mio	2 8 ,91-93	FAHLBUSCH, instrumè ts pour la b irurgie mic o	148
Cise x p u né s	22	FAHLBUSCH, instrumè ts pour la b irurgie pituitaire	165
Cise x , tgs èe U C	29-33	FERGUSSON, e nule d'aspiration	56
CLEVELAND, jne -goge	74	FERRIS-SMITH, pine pour lame inte ve t b rales	158
Clp	p p 0 9-111	FERRIS-SMITH-CUSHING, pine en porte pièe s à laminet omie	157
Clp p u anè me	109-111	Fils sè es	98
CLOWARD, b t anè nè	71	FISCH, c ob è s à ne fs	130
CLOWARD, é b p u o p b aux	122,124	FRAZIER, e nule d'aspiration	56
CLOWARD, jne en p è jè à la minè mie	156	FRAZIER, crochets très fins	44
CLOWARD moif ., é ab	122	FRAZIER, disst e rs à dure mè e	133
Conducteurs pour fils scies	98	FREER, é é atè rs	72
CONE, é b	51	FRIEDMAN, pine -goge	74
Connè ion	176	FRIEDMAN-MINI, pine -goge	74
CONVERSE, p è aigilè tgs tà e U C	37	FRYKHOLM, pine -goge	79
COTTLE, ç a x -b ins	162	<b>G</b>	
COTTLE, ma b x	69	GEMINI, pine à disst ion	10
CRILE-WOOD, p è aigilè tg stà e U C	38	GILLIES, crochets très fins	44
Co b à d mè	131	GOLDMAN-FOX, ç sa ux tungstà e U C	33
Co b à gab	108	GRAHAM, c ob è s à dure mè e	131
Co b à né s	2 9,130	GRONINGEN, c ob è s à ne fs	129
Crochets pour fils scies	98		

## H

<b>HAJEK-KOFFLER</b> , jne p ur la me inte ve tē rab	159
<b>HALSEY</b> , p e aiguille tūg stā e U C	37
<b>HARDY</b> , instn est p u à tūjie jūa ie	β 165
<b>HARDY-FAHLBUSCH</b> , instn est p u à tūjie jūa ie	165
<b>HARMS</b> , á b pou o p s ve tē rax	125
<b>HARTMANN</b> , jne -gouge	75
<b>HEIFETZ</b> , jne p ur saisir le tissu	15
<b>HEIFETZ</b> , sp b cē ab	104
<b>HEY</b> , á b msi b ie	114
<b>HIBBS SPRATT</b> , b t anā nē	71
<b>HOEN</b> , is sē s à el mē e	133
<b>HOEN</b> , é ab	73
<b>HOEN</b> , jne én osā tq e	85
<b>HORSLEY</b> , é ab p u rainē ne ve sē	127
<b>HOSOBUCHI</b> , instn est p u à tūjie jūa ie	167
<b>HUNT</b> , jne p ur saisir le tissu	15

## I

<b>INGE</b> , á b pou o p s e rtē rax	126
Instn est p u à tūjie mio	β β β β 149
Instn est p u à tūjie jūa ie	6 167
Instn est p u loā d ā ne	β 99
Instn est ses itē	60

## J

<b>JACOBSON</b> , instn est p u à tūjie mio	143
<b>JACOBSON</b> , p e aiguille	42
<b>JACOBSON</b> , p e aiguille tūgs tē U C	40
<b>JANSEN</b> , á b	48

## K

<b>KERRISON</b> , jne p ur la me inte ve tē rab	β 159
<b>KERRISON-COLCLOUGH</b> , jne pou la me inte ve tē rab	153
<b>KILNER</b> , crochets très fins	44
<b>KLEINERT-KUTZ</b> , crochets très fins	44
<b>KLEINERT-KUTZ</b> , jne -gouge	77
<b>KOOS</b> , instn e s p u à b irurgie mic o	141
<b>KRAUS</b> , instn est p u à tūjie mio	142
<b>KRAYENBÜHL</b> , o b à nē s	130

## L

<b>LANDOLT</b> , écart pou la b igie jūa ie	162
<b>LANDOLT</b> , instn e s p u à tūjie jūa ie	166
<b>LANDOLT</b> , pince en p e jē e p u à tūjie e jūa ie	161
<b>LANDOLT-REULEN</b> , instn e s p u à b irurgie pituitaire	167
<b>LANGENBECK</b> , é ab	72
<b>LANGENBECK</b> , p e aiguille tūgs tē e U C	39
<b>LEMPERT</b> , jne -gouge	76
<b>LEXER</b> , is e x -b ins	6 ,67
<b>LEXER</b> , is e x tūngs tē U C	31
<b>LEXER</b> , osé b mes	67
<b>LEXER-MINI</b> , is e x -b ins	66
<b>LEYLA</b> , á b cē ab	∅ 103
<b>LOVE-GRUENWALD</b> , jne pou la me inte ve tē rab	154
<b>LOVE</b> , é ab p u rainē ne ve sē	128
<b>LOVE</b> moif ., é ab p u raē ne ne ve sē	128
<b>LUER</b> , jne -gouge	75

## M

<b>MARQUARDT</b> , jne -gouge	76
Ma b x	β 9 θ ,70
Ma b x -β	8 ,59
<b>MARTEL</b> , conducteurs pour fils scies	98
<b>MARTEL</b> , jne p u è ū b	8

<b>MARTIN</b> , ré rat e rs pour raē ne ne ve sē	128
<b>MATHIEU</b> , porte aiguille tūgstā e U C	39
<b>MATHIEU-DELICATE</b> , porte aiguille tūgstā e U C	39
<b>MATHIEU-RYDER-MICRO</b> , porte aiguille tūgstā e U C	39
<b>MAYFIELD</b> , pine -gouge	76
<b>MAYO</b> , c sa ux tūgstā e U C	29
<b>MAYO-HEGAR</b> , porte aiguille tūgstā e U C	36
<b>MAYO-HEGAR-DELICATE</b> , porte aiguille tūgstā e U C	36
<b>MC KENZIE</b> , pine pour le a ir b e e u	106
<b>MC KENZIE</b> , support pour le a ir b e e u	107
<b>MEAD</b> , pine -gouge	75
<b>METZENBAUM</b> , c sa ux tūgstā e U C	29-32
<b>METZENBAUM-DELICATE</b> , c sa ux tūgstā e U C	31,32
<b>MEYERDING</b> , á rtē rs	47
<b>MICRO-ADSON</b> , pine à dissē ion	12
Mic o-ē seaux	23-28,91-93
<b>MICRO-MOSQUITO</b> , pine hēn ostatique	9
Mic o-pine	16-18,88-90
Mic o-porte-aiguille	41,42,94
<b>MICRO-RYDER</b> , porte aiguille tūgstā e U C	37
<b>MILLES</b> , mic o-ē se ux	92
<b>MILLIGAN</b> , dissē e rs à dure mē e	134
<b>MINI</b> , pine pour pose le c ips d'anē risme	113
<b>MINI-FRIEDMAN</b> , pine -gouge	74
<b>MINI-LEXER</b> , c sa ux-burins	66
<b>MINI-RUSKIN</b> , pine -gouge	77
<b>MOLDESTAD</b> , crochets très fins	45

## N

<b>NAGEL</b> , mic o-ē se ux	91
<b>NEIVERT</b> , porte aiguille tūgstā e U C	37
<b>NICOLA</b> , instrumē ts pour la b irurgie mic o	149
<b>NICOLA</b> , instrumē ts pour la b irurgie pituitaire	164

## O

<b>OKONEK</b> , instrumē ts pour la b irurgie mic o	144
<b>OLDBERG</b> , pine en porte piē à laminē omie	157
<b>OLIVECRONA</b> , c sa ux	22
<b>OLIVECRONA</b> , dissē e rs à dure mē e	134
<b>OLIVECRONA</b> , spatule é b rale	104
<b>OLIVECRONA-GIGLI</b> , fils scies	98
<b>OLIVECRONA-TOENNIS</b> , pine pour le a ir b e e u	106
<b>OMBREDANNE</b> , marte ux	69
∅ tē tomes	66-68

## P

<b>PENFIELD</b> , dissē e rs à dure mē e	135
Pe foratē rs à main	62,63
Pine s	11-20,89,90
Pine s à dissē ion	10,86
Pine s à ligature ave plate forme	16,17
Pine s atrauma	19
Pine s d'horloger	14
Pine s de trat ion c āniē ne	100
Pine s emporte-piē à laminē omie	154-157
Pine s emporte-piē pour la b irurgie pituitaire	161
Pine s-gouges	74-80
Pine s hēn ostatiques	9,85
Pine s hēn ostatiques pour le a ir b e e u	8
Pine s mic o	16-18,88-90
Pine s pour c āne	99
Pine s pour la B -Coagulation	171
Pine s pour lames inte ve tē rale	150-153,158-160
Pine s pour le a ir b e e u	105-107
Pine s pour poser le c ips d'anē risme	112,113
Pine s pour saisir les tissus	15
Pine s pour sutures	89
Pine s, tūgstēne U C	20

	Page		Page
<b>PLATTFUSS</b> , jne p ur l a me inte ve t e r a b	160	<b>W</b>	
<b>PLESTER</b> , e n b d asj r a to n	56	<b>WARTENBERG</b> , instrum e ts se sibilite	60
Po e aig u l e	42,94-97	<b>WEITLANER</b> , e r t e rs	49
Po e aig u l e , mio	41,42,94	<b>WILLET-MARTEL</b> , pine pour le a ir b e e u	8
Po e aig u l e , t g s e ne U C	36-40	<b>WULLSTEIN-MICRO</b> , e nule d'aspiration	56
<b>R</b>		<b>Z</b>	
<b>RABINER</b> , ma b x -p s	58	<b>ZAUFAL-JANSEN</b> , pine -gouge	77
<b>RAIMONDI</b> , jne e n o s a t q e	85		
<b>RALK</b> , p o r a b a main	63		
<b>RANEY</b> , t p	107		
<b>RANEY</b> , jne p ur l e i r b e e u	107		
<b>RAY</b> , inst m e s p u l a t g i e j b i e	163		
R a b p u r a i n e s n e e	2 7,128		
<b>RUSKIN</b> , jne -gouge	7 7,78,80		
<b>RUSKIN-MINI</b> , jne -gouge	77		
<b>S</b>			
<b>SACHS</b> , i s s a a e l m e	133		
<b>SACHS</b> , e a b p u r a i n e n e e	127		
<b>SAMII</b> , inst m e t p u l a b i r u r g i e m i c o	139		
<b>SAMII</b> , jne p ur s a i s i r e t i s s u s	15		
<b>SCALP-CONTOUR</b> , e e u r s	53		
<b>SCHLESINGER</b> , jne e n p e j e a l a m i n e o m i e	155		
<b>SCHMIEDEN-TAYLOR</b> , i s e x	22		
<b>SCOVILLE</b> , e e	106		
<b>SCOVILLE</b> , e a b p u r a i n e n e v e s e	127		
<b>SCOVILLE-HAVERFIELD</b> , e c a t e r s	120		
<b>SCOVILLE-RICHTER</b> , e t e r s	121		
<b>SELVERSTONE</b> , jne e n p e j e a l a m i n e m i e	155		
<b>SEMB</b> , jne -gouge	78		
<b>SMITH-PETERSON</b> , jne s-gouge	80		
<b>SMITHWICK</b> , o b a n e f s	129		
<b>SNITMAN</b> , e e	48		
p b e a b	104		
e n s p u l a t g i e j b i e	162		
<b>SPINAL FUSION</b> , e t r a n b n e	71		
<b>SPURLING</b> , jne p ur l a me inte ve t e r a b	154		
<b>STANDARD</b> , i s e x t i n g s e e U C	29		
<b>STANDARD</b> , jne p ur p s e e t i p s d'a n e r i s m e	113		
<b>STELLBRINK</b> , jne -gouge	74		
<b>STILLE</b> , p o r a b a main	62		
<b>STILLE</b> , jne -gouge	78		
<b>STILLE-RUSKIN</b> , jne -gouge	78		
<b>STRULLY</b> , i s e x	22		
p t p u l e i r b	107		
<b>T</b>			
<b>TAYLOR</b> , e e	120		
<b>TAYLOR</b> , e e s j n a b	46		
<b>TAYLOR</b> , ma b x -p s	58		
<b>TOENNIS-ADSON-DELICATE</b> , c i s e a u x t u g s e e U C	33		
<b>TÖNNIS</b> , i s s a a e l m e e	132		
<b>TROEMNER</b> , ma b x -p r s	59		
<b>U</b>			
<b>UNIVERSAL</b> , i s e x t i n g s e e U C	33		
<b>UNIVERSAL</b> , jne -gouge	74		
<b>V</b>			
<b>VANNAS</b> , m i o -i s e a x	92		





	Pagina		Pagina
<b>A</b>			
Á a b e	176		
ADSON, a nné d asp aáo ne	56		
ADSON, ðv aia b í	50		
ADSON, é ab í	73		
ADSON, jnæ p ð sío ne	12		
ADSON, jnæ tåg sáo U C	20		
ADSON, úmí p d a-mæd	131		
ADSON-BROWN, jnæ pe dissé one	12		
Ár afe al o io a þ o			
ALM, ðv aia b í	48		
ALY, stn et p sés ib litá	60		
ANDERSON-ADSON, ðv aia b í	49		
AUSTIN, jnæ p lga t a a n piattaforma	16		
<b>B</b>			
BABINSKY, maé p a soí	58		
BABY-ADSON, jnæ en osá tð	9		
BABY-CRILE-WOOD, p a gh tågs áo U C	38		
BABY-MIXTER, jnæ p p ráz oni	10		
BABY-OVERHOLT, jnæ en osá tð	9		
BACON, jnæ sgotæ	76		
BARRAQUER, mio -p t agh	94		
BECKMANN, ðv aia b í	51		
BECKMANN-ADSON, ðv aia b í	52		
BECKMANN-EATON, ðv aia b í	52		
BELLUCCI, stn et p a b irurgia mic o	148		
BERLINER, maé p a soí	59		
BEYER, jnæ sgortæ	77		
BIEMER, úmí p nê	130		
BLUMENTHAL, jnæ sgotæ	75		
BÖHLER, jnæ sgortæ	77		
BUCK, maé p a soí	58		
<b>C</b>			
Canná d asp aáo ne	56		
CASPAR, ðv aia b í	119		
CASPAR, ðv aia b í b al	1 6,118		
CASPAR, jnæ a glæt p laminé omia	156		
CASPAR, stn et p a b irurgia mic o	3 138,143		
CASTROVIEJO, p a gh tågs áo U C	40		
Caiv d o nne íone	170		
Cavo fibra ottica	175		
CLEVELAND, jnæ sgortæ	74		
Clp	p p 0 9-111		
Clp p anis mi	109-111		
CLOWARD, a a glæt	71		
CLOWARD, jnæ a glæt p a miné mia	156		
CLOWARD, sp rab í p b	2 2,124		
CLOWARD modf ., d vaic atori	122		
CONE, ðv aia b í	51		
CONVERSE, p a gh tågs áo U C	37		
COTTLE, maé	69		
COTTLE, sa þ	162		
CRILE-WOOD, p a gh tågs áo U C	38		
CRUTCHFIELD, jnæ p t aáz one c aniaé	100		
Cá a glæt	71		
CUSHING, ðv aia b í sottí	45		
CUSHING, ðv aia b í sjna l	46		
CUSHING, jnæ p ð sío ne	13		
CUSHING, jnæ a glæt pe disb i inte ve tð ral	154		
CUSHING, jnæ tåg sáo U C	20		
CUSHING, úmí p d a-mæd	131		
CUSHING-LANDOLT, specoli per ipofisi cerebrale	162		
CUSHING-TAYLOR, jnæ tungsbó U C	20		
<b>D</b>			
DAHLGREEN, pinæ pe il c anio	99		
DAHMEN, osté tomi	68		
DAHMEN, sa lþé li	68		
DANDY, forbic	22		
DANDY, pinæ pe prþ aráz oni	10		
DANDY, unc ní pe ne vi	129		
DAVIS, dissé ori pe dura-madre	132		
DE BAKEY, pinæ atrauma	19		
DE BAKEY, portaghi tungstæ o U C	36		
DE VILBISS, pinæ pe il c anio	99		
DÉJERINE, marté li pe a ssori	59		
DIETHRICH, mic o-pinæ	90		
D ssetori per dura-madre	132-135		
D varia tori	44-53,114-128		
D varia tori autostatiç	48-53		
D varia tori e ebrali	101-103		
D varia tori muso lari	114,115		
Divaricatori per ipofisi cerebrale	162		
D varia tori sottili	44,45		
D varia tori spinali	46		
D varia tori vertebrali	116-118		
<b>E</b>			
Easç lean pinæ taglienti pe laminet omia	151,152		
ECHLIN, pinæ sgorbie	79		
Elevatori	72,73		
<b>F</b>			
FAHLBUSCH, strumenti per ipofisi cerebrale	165		
FAHLBUSCH, strumæ ti pe la b irurgia mic o	148		
FERGUSON, a nnule di aspiráz one	56		
FERRIS-SMITH, pinæ taglienti pe disb i inte ve tð rali	158		
FERRIS-SMITH-CUSHING, pinæ taglie ti pe laminé omia	157		
Fili sg a	98		
FISCH, unc ní pe ne vi	130		
Forbic	21-34,91-93		
Forbic pe ne vi	22		
Forbic , mic o	23-28,91-93		
Forbic , tungsteno U C	29-33		
FRAZIER, a nnule di aspiráz one	56		
FRAZIER, dissé ori pe dura-madre	133		
FRAZIER, divaria tori sottili	44		
FREER, é e atori	72		
FRIEDMAN, pinæ sgorbie	74		
FRIEDMAN-MINI, pinæ sgorbie	74		
FRYKHOLM, pinæ sgorbie	79		
<b>G</b>			
GEMINI, pinæ pe prþ aráz oni	10		
GILLIES, divaria tori sottili	44		
GOLDMAN-FOX, forbic tungstæ o U C	33		
GRAHAM, unc ní pe dura-madre	131		
GRONINGEN, unc ní pe ne vi	129		
<b>H</b>			
HAJEK-KOFFLER, pinæ taglie ti pe disb i inte ve tð rali	159		
HALSEY, portaghi tungstæ o U C	37		
HARDY, strumenti per ipofisi cerebrale	163,165		
HARDY-FAHLBUSCH, strumenti per ipofisi cerebrale	165		
HARMS, sp aratori pe ve tð re	125		
HARTMANN, pinæ sgorbie	75		

<b>HEIFETZ</b> , jnæ p affe ae t̃ st̃	15	<b>METZENBAUM</b> , forbic tungstæ o U C	29-32
<b>HEIFETZ</b> , sp̃ b̃ l̃ e b̃ al	104	<b>METZENBAUM-DELICATE</b> , forbic tungstæ o U C	31,32
<b>HEY</b> , ðṽ aria b̃ i m̃s̃ o b̃ i	114	<b>MEYERDING</b> , divarie tori	47
<b>HIBBS SPRATT</b> , t̃ t̃ a glet	71	<b>MICRO-ADSON</b> , pinæ pe dissæ one	12
<b>HOEN</b> , ð s̃ t̃ i pe d̃ a-mad	130	Mic o-forbic	23-28,91-93
<b>HOEN</b> , t̃ ab̃ i	73	<b>MICRO-MOSQUITO</b> , pinæ en ostatic e	9
<b>HOEN</b> , jnæ en os̃ t̃ t̃	85	Mic o-pinæ	16-18,88-90
<b>HORSLEY</b> , ðni p̃ e raic̃ ð ñe	127	Mic o-portaghi	41,42,94
<b>HOSOBUCHI</b> , strumenti per ipofisi cerebrale	167	<b>MICRO-RYDER</b> , portaghi tungstæ o U C	37
<b>HUNT</b> , jnæ p̃ affe ae t̃ st̃	15	<b>MILLES</b> , mic o-forbic	92
<b>I</b>		<b>MILLIGAN</b> , dissæ ori pe dura-madre	134
<b>INGE</b> , sp̃ rab̃ i p̃ t̃ e	126	<b>MINI</b> , pinæ pe applia re t̃ ips̃ anæ rismi	113
<b>J</b>		<b>MINI-FRIEDMAN</b> , pinæ sgorbie	74
<b>JACOBSON</b> , mio -p̃ t̃ gh	42	<b>MINI-LEXER</b> , sa lp̃ e li	66
<b>JACOBSON</b> , p̃ t̃ gh tags̃ t̃o U C	40	<b>MINI-RUSKIN</b> , pinæ sgorbie	77
<b>JACOBSON</b> , stñ et̃ p̃ t̃ a t̃gia mio	143	<b>MOLDESTAD</b> , divarie tori sottili	45
<b>JANSEN</b> , ðṽ aia b̃ i	48	<b>N</b>	
<b>K</b>		<b>NAGEL</b> , mic o-forbic	91
<b>KERRISON</b> , jnæ t̃ a glet̃ p̃ dis̃ b̃ i inte ve t̃ b̃ ral	159	<b>NEIVERT</b> , portaghi tungstæ o U C	37
<b>KERRISON-COLCLOUGH</b> , jñ æ pe ð s̃ b̃ inte ve t̃ b̃ ral	153	<b>NICOLA</b> , strumenti per ipofisi cerebrale	164
<b>KILNER</b> , ðṽ aia b̃ i sotl̃	44	<b>NICOLA</b> , strum̃ t̃ i pe la b̃ irurgia mic o	149
<b>KLEINERT-KUTZ</b> , ðṽ aia b̃ i sotl̃	44	<b>O</b>	
<b>KLEINERT-KUTZ</b> , jnæ sgorbæ	77	<b>OKONEK</b> , strum̃ t̃ i pe la b̃ irurgia mic o	144
<b>KOOS</b> , stñ et̃ p̃ t̃ a b̃ ig̃ ia mic o	141	<b>OLDBERG</b> , pinæ taglia ti pe laminæ omia	157
<b>KRAUS</b> , stñ et̃ p̃ t̃ a t̃gia mio	142	<b>OLIVECRONA</b> , dissæ ori pe dura-madre	134
<b>KRAYENBÜHL</b> , ðni p̃ ñe	130	<b>OLIVECRONA</b> , forbic	22
<b>L</b>		<b>OLIVECRONA</b> , spatoli e b̃ rali	104
<b>LANDOLT</b> , divaricatori per ipofisi cerebrale	162	<b>OLIVECRONA-GIGLI</b> , fili sega	98
<b>LANDOLT</b> , pinze taglianti per ipofisi cerebrale	161	<b>OLIVECRONA-TOENNIS</b> , pinæ pe il a oio a p̃ luto	106
<b>LANDOLT</b> , strumenti per ipofisi cerebrale	166	<b>OMBREDANNE</b> , mart̃ e li	69
<b>LANDOLT-REULEN</b> , strumenti per ipofisi cerebrale	167	⊙ t̃ e tomi	66-68
<b>LANGENBECK</b> , t̃ ab̃ i	72	<b>P</b>	
<b>LANGENBECK</b> , p̃ t̃ gh tags̃ t̃o U C	39	<b>PENFIELD</b> , dissæ ori pe dura-madre	135
<b>LEMPERT</b> , jnæ sgot̃ e	76	Pe foratori a mano	62,63
<b>LEXER</b> , folit̃ t̃ gs̃ t̃o U C	31	Pinæ	11-20,89,90
<b>LEXER</b> , os̃ t̃ b̃ mi	67	Pinæ -sgorbie	74-80
<b>LEXER</b> , sa p̃	6,67	Pinæ al a oio a p̃ luto	105-107
<b>LEXER-MINI</b> , sa p̃	66	Pinæ atrauma	19
<b>LEYLA</b> , ðṽ aia b̃ i t̃ al	103	Pinæ da orologiaio	14
<b>LOVE-GRUENWALD</b> , jnæ pe ð s̃ b̃ inte ve t̃ b̃ ral	154	Pinæ en ostatic e	9,85
<b>LOVE</b> , ðni p̃ e raic̃ ð ñe	128	Pinæ en ostatic e pe il a oio a pelluto	8
<b>LOVE</b> mod̃ ., ðni p̃ e raic̃ ð ñe	128	Pinæ per afferrare t̃ e suti	15
<b>LUER</b> , jnæ sgorbæ	75	Pinæ per applia re t̃ ips̃ aneurismi	112,113
<b>M</b>		Pinæ per il c anio	99
Manico per fili sega	98	Pinæ per la B -Coagulaž one	171
<b>MARQUARDT</b> , jnæ sgorbæ	76	Pinæ per ligatura o n piattafoma	16,17
<b>MARTEL</b> , jnæ p̃ il a io a p̃	8	Pinæ per preparaz̃ one	10,86
<b>MARTEL</b> , sonda per introdurre fili sega	98	Pinæ per sutura	89
Maè	8 9 10 ,70	Pinæ per traž̃ one c aniale	100
Maè p̃ soir	8 ,59	Pinæ taglia ti per dis̃ b̃ i inte ve t̃ b̃ rali	150-153,158-160
<b>MARTIN</b> , ðni p̃ e raic̃ d̃ e ne vi	128	Pinze taglianti per ipofisi cerebrale	161
<b>MATHIEU</b> , p̃ t̃ gh tags̃ t̃o U C	39	Pinæ taglia ti per laminæ omia	154-157
<b>MATHIEU-DELICATE</b> , p̃ t̃ ghi tags̃ t̃o U C	39	Pinæ , mic o	16-18,88-90
<b>MATHIEU-RYDER-MICRO</b> , p̃ t̃ gh tags̃ t̃o U C	39	Pinæ , tungstæ o U C	20
<b>MAYFIELD</b> , jnæ sgorbæ	76	<b>PLATTFUSS</b> , pinæ taglia ti pe dis̃ b̃ i inte ve t̃ b̃ rali	160
<b>MAYO</b> , folit̃ t̃ gs̃ t̃o U C	29	<b>PLESTER</b> , a nnule di aspiraž̃ one	56
<b>MAYO-HEGAR</b> , p̃ t̃ gh tags̃ t̃o U C	36	Portaghi	36-42,94-97
<b>MAYO-HEGAR-DELICATE</b> , p̃ t̃ ghi tags̃ t̃o U C	36	Portaghi, mic o	41,42,94
<b>MC KENZIE</b> , jnæ p̃ il a io a p̃ luto	106	Portaghi, tungstæ o U C	36-40
<b>MC KENZIE</b> , sp̃ e pe il a io a p̃ luto	107	<b>R</b>	
<b>MEAD</b> , jnæ sgorbæ	75	<b>RABINER</b> , mart̃ e li pe a ssori	58
		<b>RAIMONDI</b> , pinæ en ostatic e	85
		<b>RALK</b> , pe foratori a mano	63

	Pagina		Pagina
<b>RANEY</b> , ip	107	<b>W</b>	
<b>RANEY</b> , ipne al o oio e p luto	107	<b>WARTENBERG</b> , strumè ti pe sà sibilità	60
<b>RAY</b> , strumenti per ipofisi cerebrale	163	<b>WEITLANER</b> , divaria tori	49
<b>RUSKIN</b> , ipne sgorlè	7, 78, 80	<b>WILLET-MARTEL</b> , pinè pe il o oio e pè luto	8
<b>RUSKIN-MINI</b> , ipne sgorlè	77	<b>WULLSTEIN-MICRO</b> , a nnule di aspiraz one	56
<b>S</b>		<b>Z</b>	
<b>SACHS</b> , it sè i p d a-madre	133	<b>ZAUFAL-JANSEN</b> , pinè sgorbie	77
<b>SACHS</b> , ùni p è raìt i dè ne vi	127		
<b>SAMII</b> , ipne p affe ae t st	15		
<b>SAMII</b> , stm et p b b rurgia mic o	139		
<b>SCALP-CONTOUR</b> , ùv aia b i	53		
è p	66-68		
<b>SCHLESINGER</b> , ipne a gliet p laminè omia	155		
<b>SCHMIEDEN-TAYLOR</b> , foliè	22		
<b>SCOVILLE</b> , ùv aia b i	106		
<b>SCOVILLE</b> , ùni p è raìt èl nè	127		
<b>SCOVILLE-HAVERFIELD</b> , ùv aia b i	120		
<b>SCOVILLE-RICHTER</b> , ùv aia b i	121		
<b>SELVERSTONE</b> , ipne a glet p b minè mia	155		
<b>SEMB</b> , ipne sgorlè	78		
è rab i p b	124-126		
èo lè	66-68		
<b>SMITH-PETERSON</b> , ipne -sgorlè	80		
<b>SMITHWICK</b> , ùni p ne vi	129		
<b>SNITMAN</b> , ùv aia b i	48		
Sonda per introdurre fili sega	98		
è b l è al	104		
Specoli per ipofisi cerebrale	162		
<b>SPINAL FUSION</b> , è taglet	71		
<b>SPURLING</b> , ipne a glet i pe disb i inte ve tè ral	154		
<b>STANDARD</b> , foliè ti gsbo U C	29		
<b>STANDARD</b> , ipne p a p e è ips anè rismi	113		
<b>STELLBRINK</b> , ipne sgorlè	74		
<b>STILLE</b> , è orab i a mano	62		
<b>STILLE</b> , ipne sgorlè	78		
<b>STILLE-RUSKIN</b> , ipne sgorlè	78		
<b>STRULLY</b> , foliè	22		
Strumenti per ipofisi cerebrale	161-167		
è et p b l gja mio	è è è 4 8, 149		
è et p l a p a d l c anio	98, 99		
è et p ses itè	60		
è t p il o oio e p	107		
<b>T</b>			
<b>TAYLOR</b> , ùv aia b i	120		
<b>TAYLOR</b> , ùv aia b i spna l	46		
<b>TAYLOR</b> , maè p a soì	58		
<b>TOENNIS-ADSON-DELICATE</b> , fob ic tungstèo U C	33		
<b>TÖNNIS</b> , it sè i pe d a-madè	132		
<b>TROEMNER</b> , maè p a soì	59		
<b>U</b>			
Unni p d a-madè	131		
Unni p gab	108		
Unni p è raìt dè ne vi	2 7, 128		
Unni p nè	2 9, 130		
<b>UNIVERSAL</b> , foliè ti gsbo U C	33		
<b>UNIVERSAL</b> , ipne sgorlè	74		
<b>V</b>			
<b>VANNAS</b> , mio -fob ic	92		



**nopa**<sup>®</sup> instruments  
traditionally modern

**nopa instruments**

Medizintechnik GmbH  
Weilatten 7-9  
78532 Tuttlingen/Germany

Tel. +49 7462 9490-0  
Fax +49 7462 9490-90  
info@nopa.de  
www.nopa.de

Herstellung und Verkauf chirurgischer  
und endoskopischer Instrumente.  
Manufacture and Sales of Surgical  
and Endoscopic Instruments.

