thorax, herz, gefäße
cardiovascular
cardiovascular
cardiovasculaire
cardiovascolare

nopa[®] instruments



Dies ist unser Katalog Thorax, Herz und Gefäßchirurgie, er bleibt unser ausschließliches Eigentum. Es gelten unsere allgemeinen Lieferbedingungen.
Sie finden diese auf unserer Internetseite: www.nopa-instruments.com.

This is our catalogue for thoracic and cardiovascular surgery. It remains our exclusive property. Please find our "General Terms of Sale" on our corporate website:
www.nopa-instruments.com.

Esto es nuestro catálogo de cirugía torácica y cardiovascular y queda nuestra propiedad. Nuestras condiciones generales de venta se encuentran en nuestra página web: www.nopa-instruments.com.

Voilà notre catalogue de chirurgie thoracique et cardiovasculaire. Il demeure notre propriété. Veuillez consulter nos conditions générales de vente sur notre page Internet: www.nopa-instruments.com.

Questo è il nostro catalogo di chirurgia toracica e cardiovascolare e rimane di nostra proprietà. Trovano applicazione le nostre condizioni generali di fornitura, che sono disponibili sul nostro sito: www.nopa-instruments.com.

corporate video



Scan QR-Code or visit
www.nopa.de

Modelländerungen vorbehalten. Nachdruck, auch auszugsweise, verboten.
Change of design and pattern reserved. Re-printing, even in extracts, not permitted.
Nos reservamos el derecho de modificaciones sin aviso previo. Reimpresión, también parcialmente, esta prohibido.
Tous droits réservés aux changements de modèle. Réimprimer, également partiellement, est interdit.
Noi riserviamo il diritto di effettuare delle modificazioni. Ristampa di divieto anche parziale.

Printed in Germany 180302

Bitte fordern Sie unsere
entsprechenden Kataloge an.

Please request for our
appropriate catalogues.

Por favor pida por nuestros
catálogos apropiados.

Veuillez demander nos
catalogues appropriés.

Chieda prego i nostri
cataloghi adatti.

>> Unser Lieferprogramm

Allgemeinchirurgie und Gynäkologie
Plastische Chirurgie und HNO
Thorax, Herz und Gefäßschirurgie
Neurochirurgie
Ophthalmologie
Endoskopie
Container und Sterilisation
Dental und Oral

>> Our product range

General Surgery and Gynecology
Plastic Surgery and ENT
Thoracic and cardiovascular surgery
Neurosurgery
Ophthalmology
Endoscopy
Container and Sterilization
Dental and Oral

**>> Nuestro gama
de productos**

Cirugía general y ginecología
Cirugía plástica y ORL
Cirugía torácica y cardiovascular
Neurocirugía
Oftalmología
Endoscopia
Contenedor y esterilización
Odontología y oral

>> Notre gamme

Chirurgie générale et Gynécologie
Chirurgie plastique et ORL
Chirurgie thoracique et cardiovasculaire
Neurochirurgie
Ophtalmologie
Endoscopie
Conteneur et stérilisation
Dental et Oral

**>> Nostro programma
di produzione**

Chirurgia generale e Ginecologia
Chirurgia plastica ed ORL
Chirurgia toracica e cardiovascolare
Neurochirurgia
Oftalmologia
Endoscopia
Contenitore e sterilizzazione
Odontoiatria e Orale

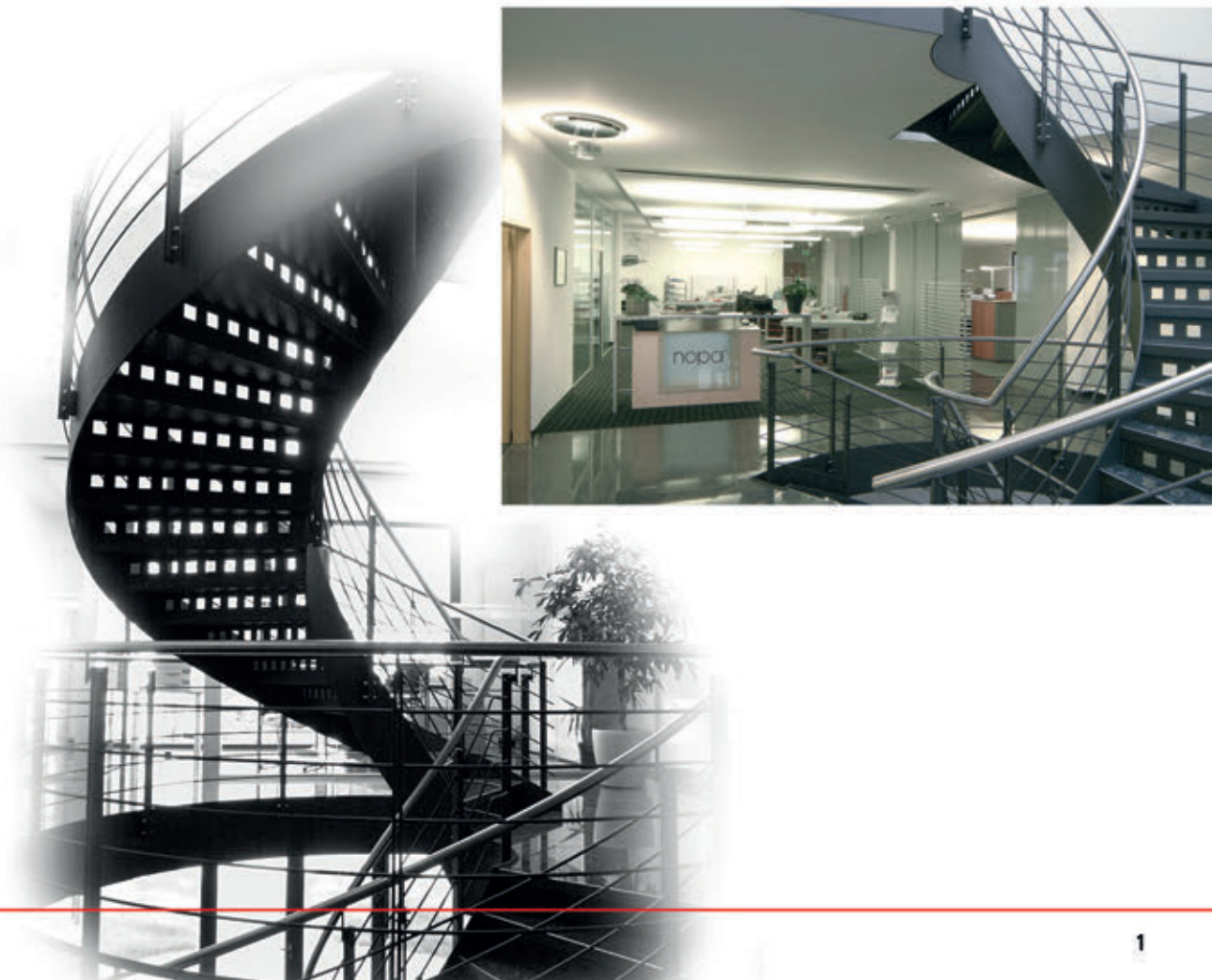

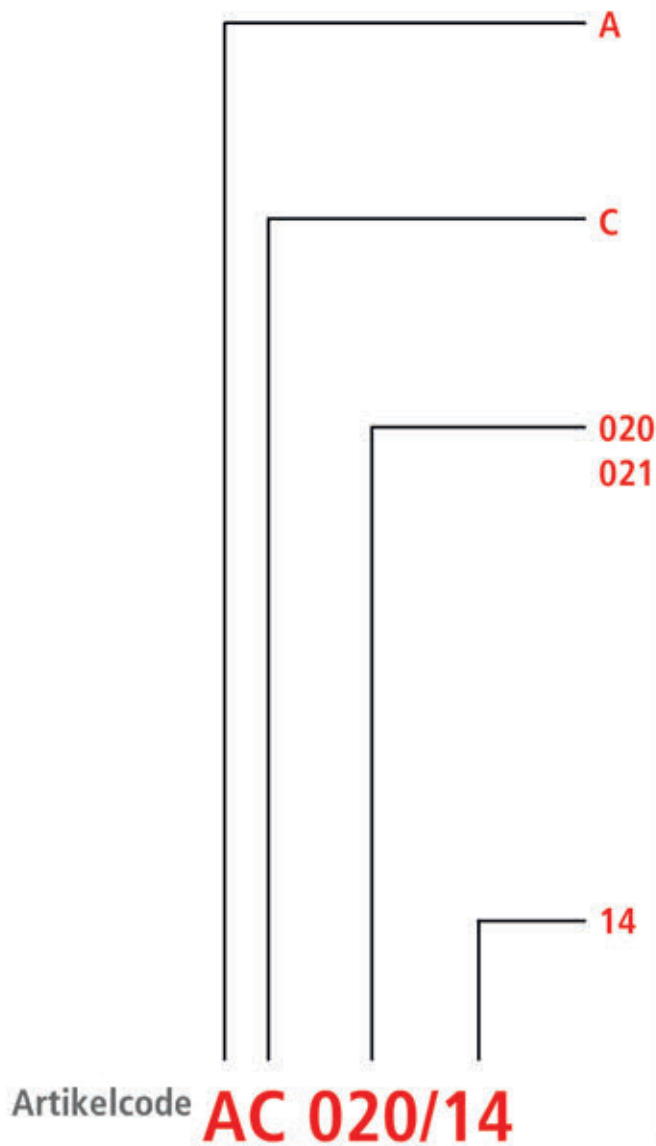
**Allgemeines Instrumentarium**

General Instruments
Instrumental Général
Instruments Générales
Strumenti generali

Scheren

Scissors
Tijeras
Ciseaux
Forbici

Fortlaufende Nummern

Gerade Ziffer = gerades Instrument
Ungerade Ziffer = gebogenes Instrument

Continuous number

Even number = straight instrument
Odd number = curved instrument

Número de orden

números pares = instrumento derecho
números impares = instrumento curvado

Numéros d'ordre

numéro pair = instrument droit
numéro impair = instrument courbe

Numeri progressivamente

numero pari = strumento retto
numero dispari = strumento curvo

Länge oder Figur

Length or Figure
Longitud o figura
Longueur ou figure
Lunghezza o figura

thorax, herz, gefäße

cardiovascular

cardiovascular
cardiovasculaire
cardiovascolare

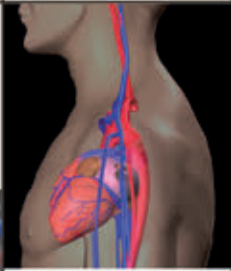

nopa[®] instruments



>> Cardiovascular • Cardiovascular • Cardiovascular • Cardiovasculaire • Cardiovascolare 9–18

>> Endarteriektomie • Endarterectomy • Endarterectomía • Endarterectomie • Endarterectomia 19–24

>> Thorakotomie • Thoracotomy • Thoracotomía • Thoracotomie • Thoracotomia 25–30

>> Koronar Arterien-Bypass • Coronary Bypass • Bypass coronario
Pontage aorto-coronarien • Bypass aorto-coronarico 31–34

>> Klemmen • Hemostats • Pinzas hemostáticas Pinces hémostatiques • Pinze emostatiche	35-68	AA
>> Pinzetten • Forceps • Pinzas • Pinces • Pinze	69-88	AB
>> Scheren • Scissors • Tijeras • Ciseaux • Forbici	89-128	AC
>> Skalpelle • Scalpels • Bisturies • Bistouris • Bisturi	129-134	AD
>> Naht • Suture • Sutura • Suture • Sutura	135-162	AE
>> Tupferzangen • Sponges Forceps • Pinzas para pólipos Pinces à pansements • Pinze per polipi	163-170	AF
>> Wundhaken • Retractors • Separadores • Ecarteurs • Divaricatori	171-198	AK
>> Gefäßinstrumente und Sonden • Vessel instruments and probes • Instrumental vascular y sondas Instruments vaisseaux et sondes • Strumenti vascolari e sonde	199-210	AL
>> Saugrohre und Kanülen • Suction tubes and cannulae • Tubos de aspiración y canulas Tubes d'aspiration et canules • Tubi d'aspirazione e cannule	211-216	AO
>> Knocheninstrumente • Bone instruments • Instrumentos para huesos Instruments des os • Strumenti per ossa	217-232	KA
>> Herz/Thorax • Cardiovascular • Cardiovascular • Cardiovasculaire • Cardiovascolare	233-300	KK
>> Endoskopie • Endoscopy • Endoscopia • Endoscopie • Endoscopia	301-344	X



KYE

- >> Bitte fordern Sie unseren Spezialkatalog für Sterilisationscontainer an.
- >> Please request for our special catalogue for Sterilization Containers.
- >> Por favor pida por nuestro catálogo especial de contenedores de esterilización.
- >> Nous vous prions de demander notre catalogue spécial des conteneurs de sterilisation.
- >> Chieda prego il nostro catalogo per contenitori di sterilizzazione.

CARDIOVASCULAR BASIC
CARDIOVASCULAR BASIC
CARDIOVASCULAR BASIC
CARDIOVASCULAIRE BASIC
CARDIOVASCOLARE BASIC

SET

ZS 941/10

Siebvorschlag - Suggested instrument set



ZS 941/10

Contents:

Qty

AA 150/12	HALSTED-MOSQUITO FCPS. STR. 12.5 CM	1
AA 151/12	HALSTED-MOSQUITO FCPS. CVD. 12.5 CM	6
AA 180/14	CRILE FORCEPS STR. 14.0 CM	2
AA 181/14	CRILE FORCEPS CVD. 14.0 CM	12
AA 201/20	ROCHESTER-PEAN FCPS. CVD. 20.0 CM	1
AA 210/16	OCHSNER-KOCHER ART. FCPS. STR. 16.0 CM	10
AA 239/18	ADSON FORCEPS CVD. 18.5 CM	3
AA 300/16	ROCHESTER-CARMALT FCPS. STR. 16.0 CM	10
AA 320/02	HEISS FORCEPS SLIGHTLY CVD. 20.0 CM	10
AA 330/24	CRAFOORD ARTERY FORCEPS CVD. 24.0 CM	3
AA 345/19	MIXTER FORCEPS CVD. 19.0 CM	6
AA 751/08	BACKHAUS TOWEL FORCEPS 8.0 CM	6
AA 751/13	BACKHAUS TOWEL FORCEPS 13.0 CM	6
AB 060/14	STANDARD TISSUE FCPS. 1X2 T. STR. 14.5 CM	2
AB 100/12	ADSON DRESSING FORCEPS 12.0 CM	1
AB 117/09	ADSON-BROWN TISS. FCPS. CVD. 9X9 T. 12.0 CM	2
AB 200/18	POTTS-SMITH DRESSING FORCEPS STR. 18.0 CM	3
AB 480/15	RUSS.MODEL TISSUE FCPS. 15.0 CM	2
AB 480/20	RUSS.MODEL TISSUE FCPS. 20.0 CM	2
AB 862/20	DE BAKEY ATRAUMA FCPS. STR. 2.0 MM 20.0 CM	4
AB 862/24	DE BAKEY FCPS. STR. 2.0 MM 24.0 CM	2
AC 072/17	MAYO-STILLE OPER. SCS. STR. BL/BL 17.0 CM	2
AC 073/17	MAYO-STILLE OPER. SCS. CVD. BL/BL 17.0 CM	2
AC 087/18	KELLY FISTULA SCISSORS CURVED 18.0 CM	1
AC 111/18	METZENBAUM-NELSON SCS. CVD. BL/BL 18.0 CM	1
AC 111/20	METZENBAUM-NELSON SCS. CVD. BL/BL 20.0 CM	1
AC 219/25	POTTS-SMITH ART. SCS. 25° DEGREE 19.0 CM	1
AC 219/45	POTTS-SMITH ART. SCS. 45° DEGREE 19.0 CM	1
AC 941/20	METZENBAUM SCS. TUC CVD. BL/BL 20.0 CM	1
AC 987/12	UNIVERSAL WIRE SHEARS TUC 12.0 CM	2
AD 010/03	SCALPEL HANDLE NO.3	6
AD 020/13	SCALPEL HANDLE NO.3 L	6
AE 100/16	MAYO-HEGAR NEEDLE HOLDER 16.0 CM	3
AE 100/18	MAYO-HEGAR NEEDLE HOLDER 18.0 CM	5
AE 100/20	MAYO-HEGAR NEEDLE HOLDER 20.0 CM	3
AF 200/25	FOERSTER-BALLENGER STR. SERRATED 25.0 CM	8
AK 036/01	CUSHING DELICATE HOOK FIG.1, 19.0 CM	2
AK 102/10	CUSHING RETRACTOR 10.0 MM 24.0 CM	2
AK 122/16	SENN-MILLER RETRACTOR SHARP 16.0 CM	4
AK 150/04	VOLKMANN RETR. SHARP 4 PRONGS 21.5 CM	4
AK 245/17	MIDDELDORPF RETRACTOR 14X17 MM 21.5 CM	2
AK 247/01	RICHARDSON RETRACTOR 28X20 MM 24.0 CM	2
AK 247/02	RICHARDSON RETRACTOR 36X28 MM 24.0 CM	2
AK 247/03	RICHARDSON RETRACTOR 44X38 MM 24.0 CM	2
AK 247/04	RICHARDSON RETRACTOR 52X22 MM 24.0 CM	2
AK 300/04	DEAVER RETRACTOR WIDTH 25.0 MM 30.0 CM	2
AK 300/08	DEAVER RETRACTOR WIDTH 50.0 MM 30.0 CM	1
AK 300/09	DEAVER RETRACTOR WIDTH 75.0 MM 30.0 CM	2
AK 374/00	PARKER RETRACTOR SET LARGE FIG.1+2	1
AK 384/00	PARKER-LANGENBECK US-ARMY SET FIG.1+2	1
AK 520/13	WEITLANER RETRACTOR SHARP 13.0 CM	2
AK 580/19	GELPI RETRACTOR 19.0 CM	2
AK 804/30	ABDOMINAL SPATULA 33.0 CM	1
AK 804/40	ABDOMINAL SPATULA 33.0 CM	1
AK 804/50	ABDOMINAL SPATULA 33.0 CM	1

ZS 941/10

Contents:

Qty

AO 400/00	YANKAUER SUCTION TUBE COMPLETE	2
AO 404/00	WALTON-YANKAUER SUCTION TUBE	2
AO 421/22	POOLE SUCTION TUBE CURVED 8.0 MM 22.0 CM	1
AO 430/10	FRAZIER BRAIN SUCTION TUBE CHARR. 10/17 CM	1
KA 520/40	WILLIGER MALLETS 400G 30.0 MM DIAM.	1
KD 055/15	ALLIS FCPS. 5x6T 15.0 CM	6
KD 055/19	ALLIS TISSUE FCPS. 5X6T 19.0 CM	3
KD 060/15	ALLIS-ADAIR TIS. SEIZ. FCPS. 10X11 15.0 CM	4
KD 111/16	BABCOCK INT. TISSUE FCPS. 16.0 CM	4
KK 040/25	LEBSCHER CHISEL 25.0 CM	1
SK 307/07	WIRE BASKET, 540X255X70 MM	2

Sterilization Container KYE 200/71, if required.

cardiovascular basic

endarterectomy

thoracotomy

coronary bypass

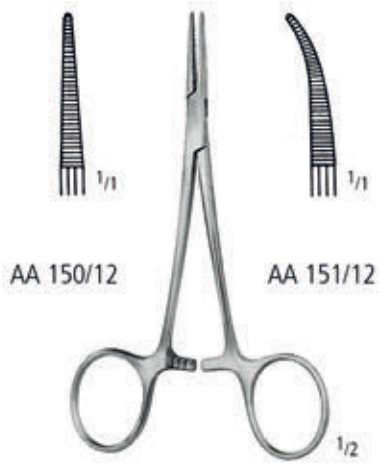

HALSTED-MOSQUITO
12,5 cm/5"

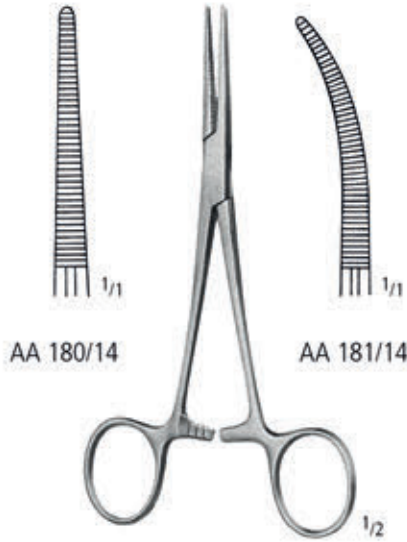

CRILE
14,0 cm/5 1/2"

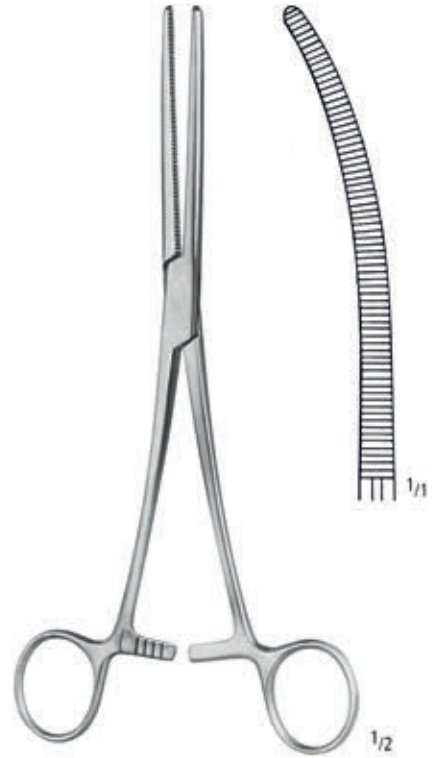

ROCHESTER-PEAN
AA 201/20
20,0 cm/8"



OCHSNER-KOCHER 1:2
AA 210/16
16,0 cm/6 1/4"



ADSON
AA 239/18
18,5 cm/7 1/3"

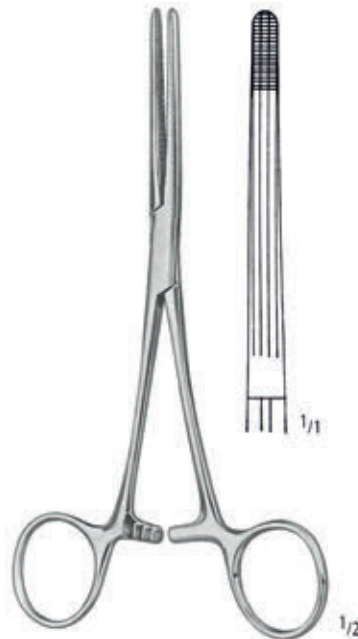

ROCHESTER-CARMALT
AA 300/16
16,0 cm/6 1/4"



HEISS
AA 320/02
20,0 cm/8"

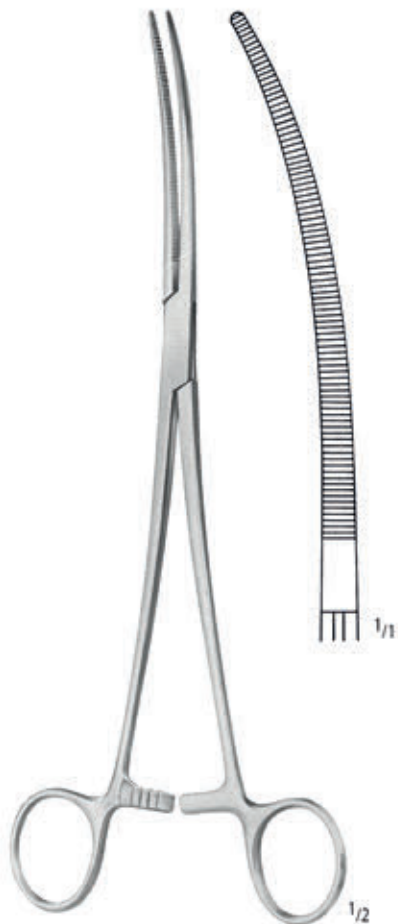

CRAFOORD
AA 330/24
24,0 cm/9 1/2"



MIXTER
AA 345/19
19,0 cm/7 1/2"



BACKHAUS
8,0 cm/3" AA 751/08
13,0 cm/5" AA 751/13



STANDARD 1:2
AB 060/14
14,5 cm/5 3/4"



ADSON
AB 100/12
12,0 cm/4 3/4"



ADSON-BROWN
AB 117/09
12,0 cm/4 3/4"



POTTS-SMITH
AB 200/18
18,0 cm/7"



RUSS. MODELL
15,0 cm/6" AB 480/15
20,0 cm/8" AB 480/20

9 : 9



AB 480/15



DE BAKHEY
20,0 cm/8" AB 862/20
24,0 cm/9 1/2" AB 862/24



2,0 mm

Fistelscheren
Fistula Scissors
Tijeras para fistulas
Ciseaux pour fistules
Forbici per fistole



MAYO-STILLE
AC 072/17
17,0 cm/6¹/₄"

MAYO-STILLE
AC 073/17
17,0 cm/6¹/₄"

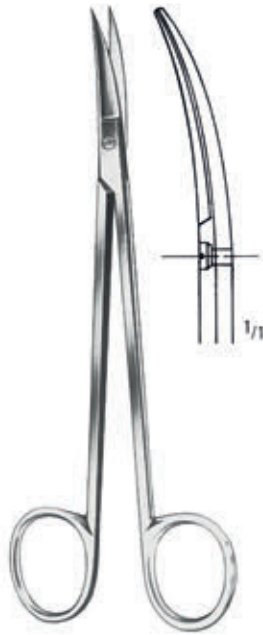

KELLY
AC 087/18
18,0 cm/7"

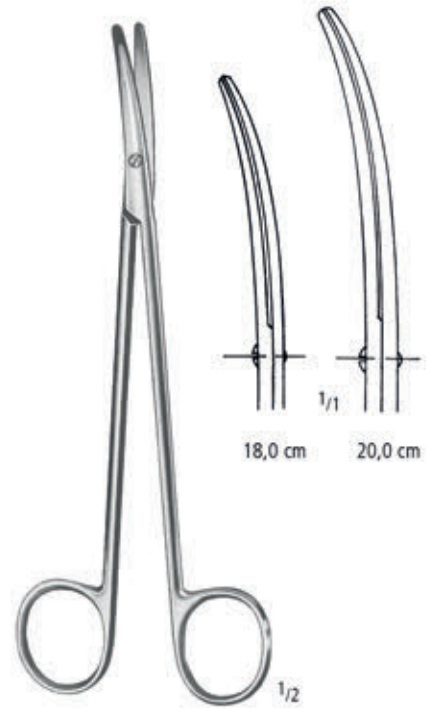

METZENBAUM-NELSON
18,0 cm/7" AC 111/18
20,0 cm/8" AC 111/20

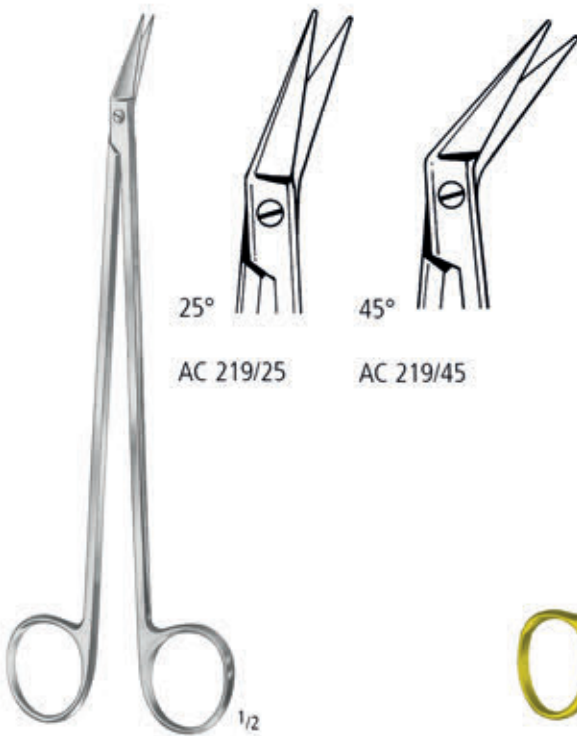

POTTS-SMITH
19,0 cm/7¹/₂"



METZENBAUM
AC 941/20 SC
20,0 cm/8"

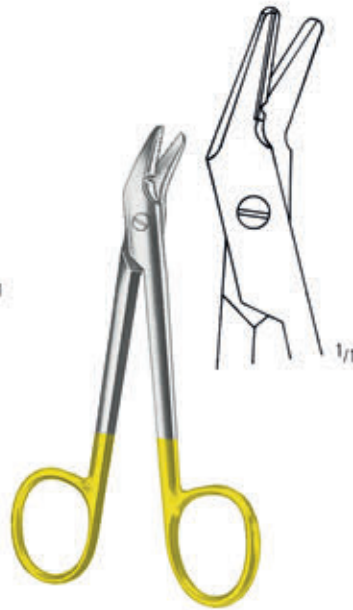

UNIVERSAL
AC 987/12
12,0 cm/4³/₄"



AD 010/03
No. 3

AD 020/13
No. 3L

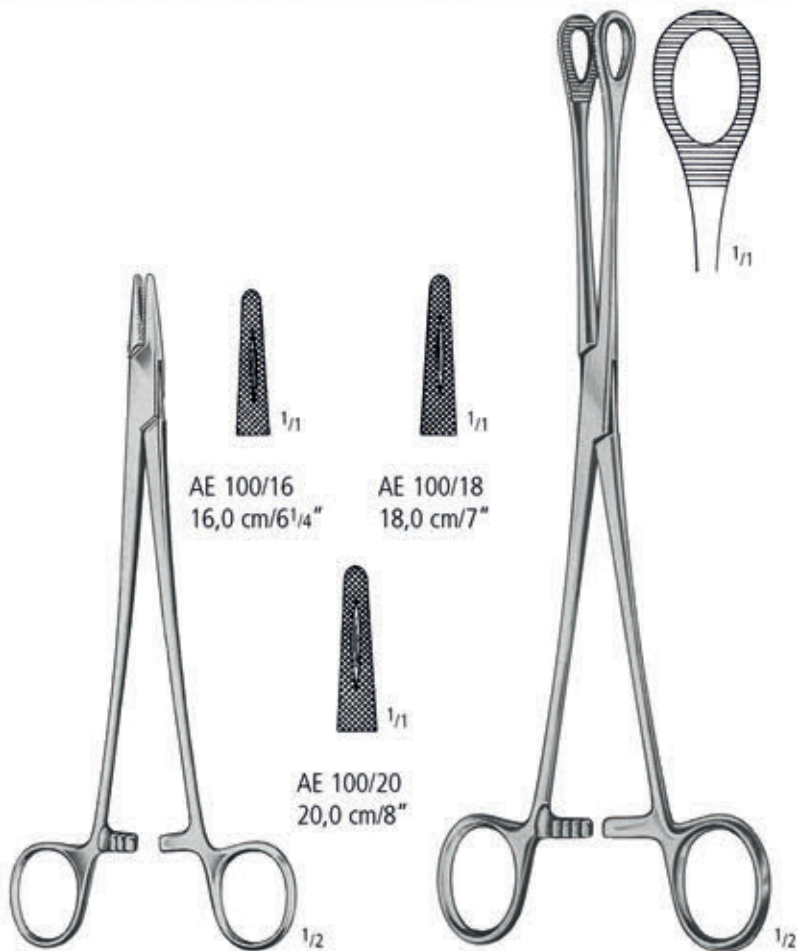

MAYO-HEGAR

FOERSTER-BALLENGER

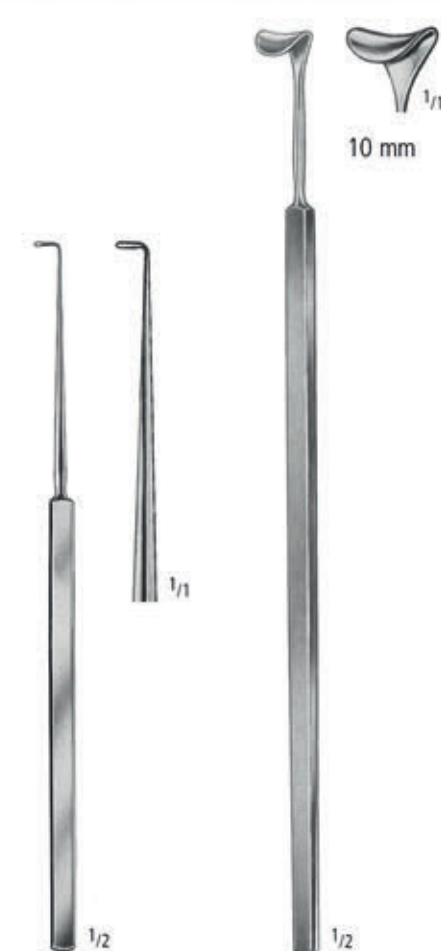

CUSHING

CUSHING



SENN-MILLER

VOLKMANN

MIDDELDORPF

RICHARDSON (KELLY)

AK 122/16
16,0 cm/6 1/4"

AK 150/04
21,5 cm/8 1/2"

AK 245/17
21,5 cm/8 1/2"

AK 247/01
28 X 20 mm

AK 247/02
36 X 28 mm

AK 247/03
44 X 38 mm

AK 247/04
52 X 22 mm



25 mm

DEAVER
AK 300/04
30,0 cm/12"



50 mm

DEAVER
AK 300/08
30,0 cm/12"



75 mm

DEAVER
AK 300/09
30,0 cm/12"



AK 374/01
Fig. 1

AK 374/02
Fig. 2

PARKER
AK 374/00 Fig. 1+2
18,0 cm/7"

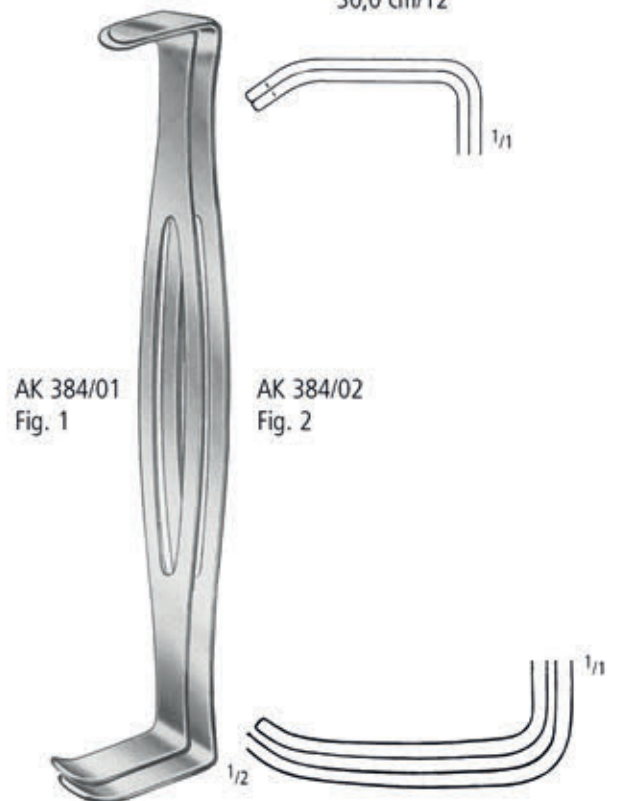

AK 384/01
Fig. 1

AK 384/02
Fig. 2

PARKER-LANGENBECK (U.S. Army)
AK 384/00 Fig. 1+2
21,0 cm/8¹/₄"



WEITLANER
13,0 cm/5" AK 520/13



GELPI
AK 580/19
19,0 cm/7 1/2"



biegsam
malleable
maleables
malléables
malleabili

33,0 cm/13"
30 mm AK 804/30
40 mm AK 804/40
50 mm AK 804/50



YANKAUER
AO 400/00
27,0 cm/11"



WALTON-YANKAUER
AO 404/00
32,5 cm/13"



POOLE
AO 421/22
8,0 mm



FRAZIER
10 Charr. AO 430/10

cardiovascular basic

endarterectomy

thoracotomy

coronary bypass



KA 520/40
Ø 30 mm
400 g (14¹/₄ oz.)

WILLIGER
24,0 cm/9¹/₂"



ALLIS 5:6
15,0 cm/6" KD 055/15
19,0 cm/7¹/₂" KD 055/19



ALLIS-ADAIR 10:11
KD 060/15
15,0 cm/6"



BABCOCK
KD 111/16
16,0 cm/6¹/₄"



LEBSCHE
KK 040/25
25,0 cm/10"

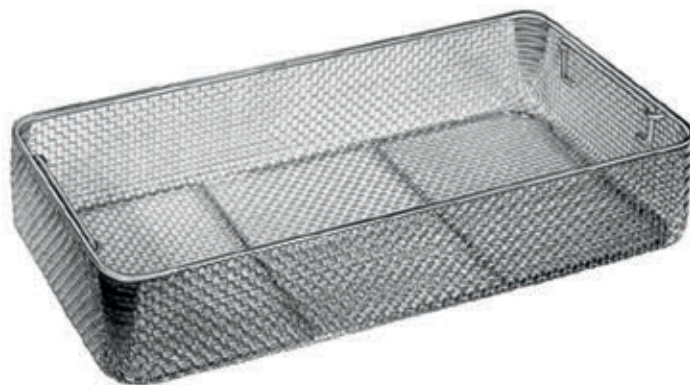

L(mm)	B(mm)	H(mm)	
540	255	70	SK 307/07

ENDARTERIEKTOMIE
ENDARTERECTOMY
ENDARTERECTOMIA
ENDARTERECTOMIE
ENDOARTERIECTOMIA

SET

ZS 941/70

Siebvorschlag - Suggested instrument set



ZS 941/70

Contents:

Qty

AA 151/12	HALSTED-MOSQUITO FCPS. CVD. 12.5 CM	12
AA 181/14	CRILE FORCEPS CURVED 14.0 CM	12
AA 201/16	ROCHESTER-PEAN FCPS. CVD. 16.0 CM	6
AA 348/18	BABY-MIXTER ART. FCPS. CVD. 18.0 CM	2
AA 751/13	BACKHAUS TOWEL FORCEPS 13.0 CM	6
AB 050/14	STANDARD DRESSING FORCEPS STR. 14.5 CM	2
AB 060/14	STANDARD TISSUE FCPS. 1X2 TEETH STR. 14.5 CM	2
AB 100/12	ADSON DRESSING FORCEPS 12.0 CM	2
AB 110/12	ADSON TISSUE FCPS. 1X2 TEETH 12.0 CM	2
AC 072/17	MAYO-STILLE OPER. SCS. STR. BL/BL 17.0 CM	1
AC 073/17	MAYO-STILLE OPER. SCS. CVD. BL/BL 17.0 CM	1
AC 111/18	METZENBAUM-NELSON SCS. CVD. BL/BL 18.0 CM	1
AC 219/45	POTTS-SMITH ART. SCS. 45° DEGREE 19.0 CM	1
AC 450/11	IRIS SCISSORS STR. SH/SH 11.5 CM	1
AC 451/11	IRIS SCISSORS CVD. SH/SH 11.5 CM	1
AD 010/03	SCALPEL HANDLE NO.3	1
AE 070/15	CRILE-WOOD NEEDLE HOLDER 15.0 CM	2
AF 200/25	FOERSTER-BALLENGER STR. SERRATED 25.0 CM	4
AK 036/01	CUSHING DELICATE HOOK FIG.1, 19.0 CM	2
AK 245/22	MIDDELDORPF RETRACTOR 20X22 MM 22.0 CM	2
AK 247/01	RICHARDSON RETRACTOR 28X20 MM 24.0 CM	2
AK 384/00	PARKER-LANGENBECK US-ARMY SET FIG.1+2	1
AL 003/13	PROBE W. EYE 13.0 CM 2.0 MM	2
AO 430/10	FRAZIER BRAIN SUCTION TUBE CHARR10/17.0 CM	2
KD 055/15	ALLIS FCPS. 5X6T 15.0 CM	4
KK 371/06	GLOVER ATRAUMA-BULLDOG CLAMP CVD. 5.5 CM	2
KK 371/07	GLOVER ATRAUMA-BULLDOG CLAMP CVD. 6.5 CM	2
KK 371/09	GLOVER ATRAUMA-BULLDOG CLAMP CVD. 8.5 CM	2
KS 638/01	PENFIELD DURA DISSECTORS FIG.1, 17.5 CM	1
SK 307/07	WIRE BASKET, 540X255X70 MM	1

Sterilization Container KYE 200/51, if required.



HALSTED-MOSQUITO

AA 151/12
12,5 cm/5"

CRILE

AA 181/14
14,0 cm/5½"

ROCHESTER-PEAN

AA 201/16
16,0 cm/6¼"

BABY-MIXTER

AA 348/18
18,0 cm/7"

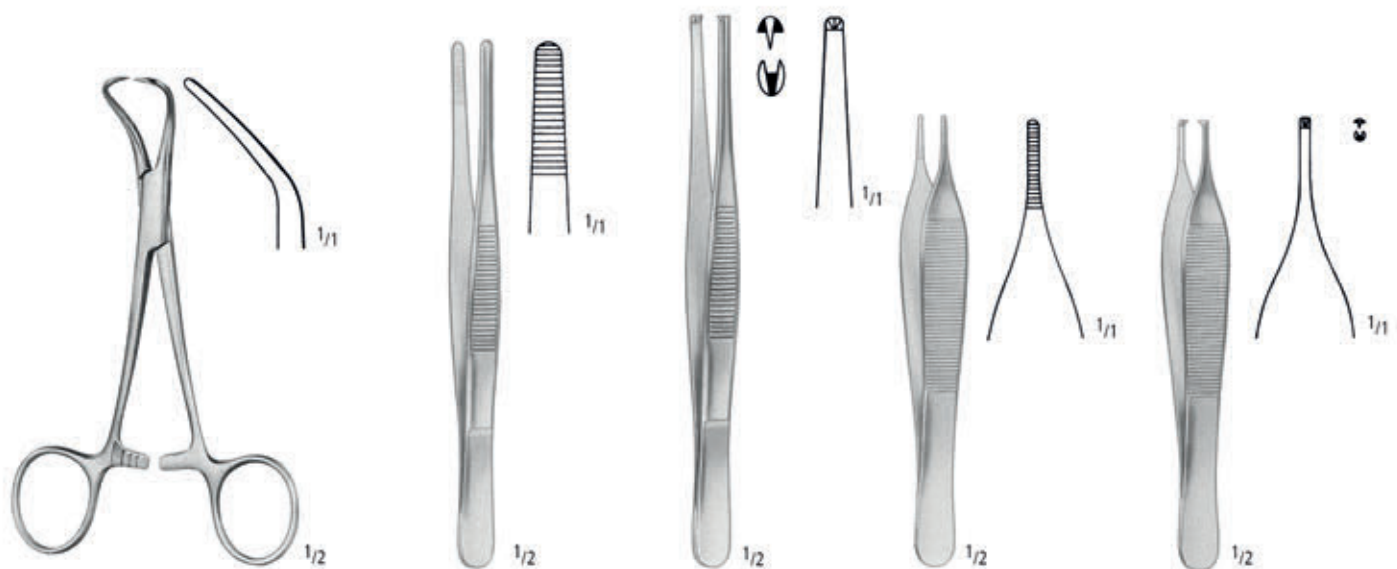

BACKHAUS

AA 751/13
13,0 cm/5"

STANDARD

AB 050/14
14,0 cm/5½"

STANDARD 1:2

AB 060/14
14,5 cm/5¾"

ADSON

AB 100/12
12,0 cm/4¾"

ADSON 1:2

AB 110/12
12,0 cm/4¾"

cardiovascular basic

endarterectomy

thoracotomy

coronary bypass

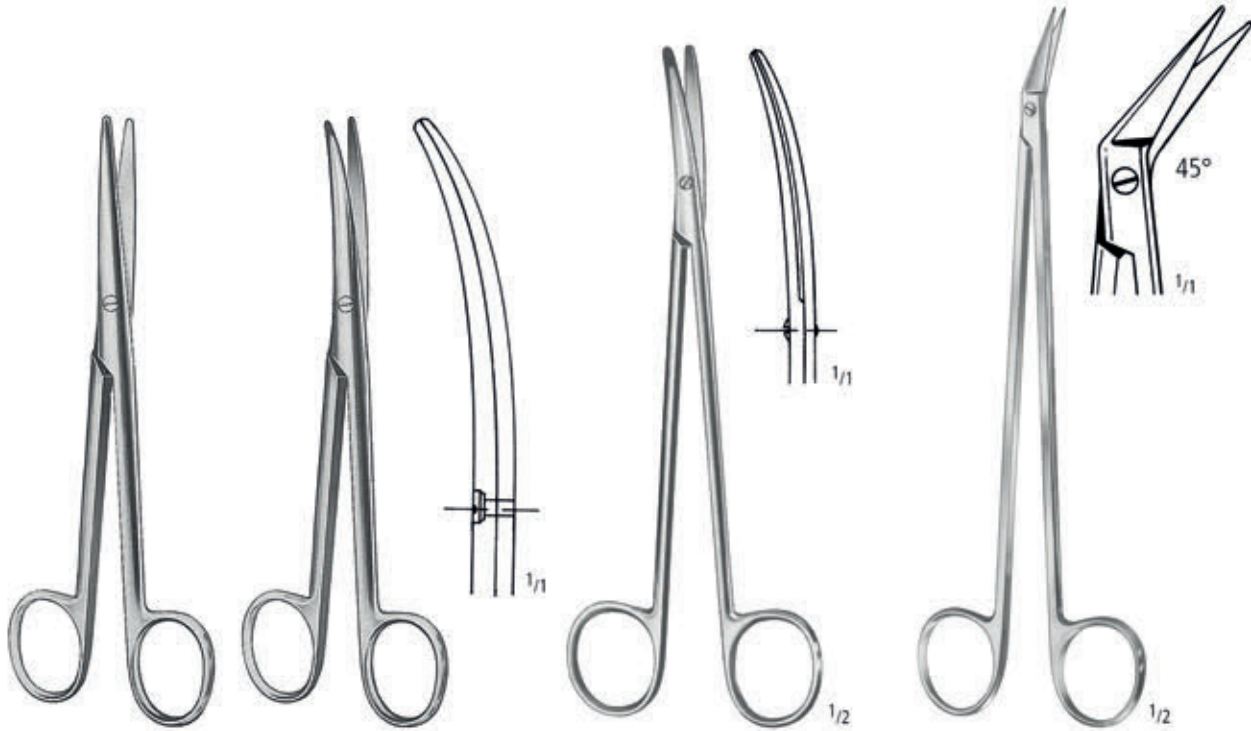

MAYO-STILLE
AC 072/17
17,0 cm/6¹/₄"

MAYO-STILLE
AC 073/17
17,0 cm/6¹/₄"

METZENBAUM-NELSON
AC 111/18
18,0 cm/7"

POTTS-SMITH
AC 219/45
19,0 cm/7¹/₂"

Irisscheren
Iris Scissors
Tijeras para iridectomía
Ciseaux à iridectomie
Forbici per iridectomia



AC 450/11
11,5 cm/4¹/₂"

AC 451/11
11,5 cm/4¹/₂"

AD 010/03
No. 3

CRILE-WOOD
AE 070/15
15,0 cm/6"

FOERSTER-BALLENGER
AF 200/25
25,0 cm/10"



CUSHING
AK 036/01
19,0 cm/7 1/2"



MIDDELDORPF
AK 245/22
22,0 cm/8 3/4"



RICHARDSON (KELLY)
AK 247/01
24,0 cm/9 1/2"

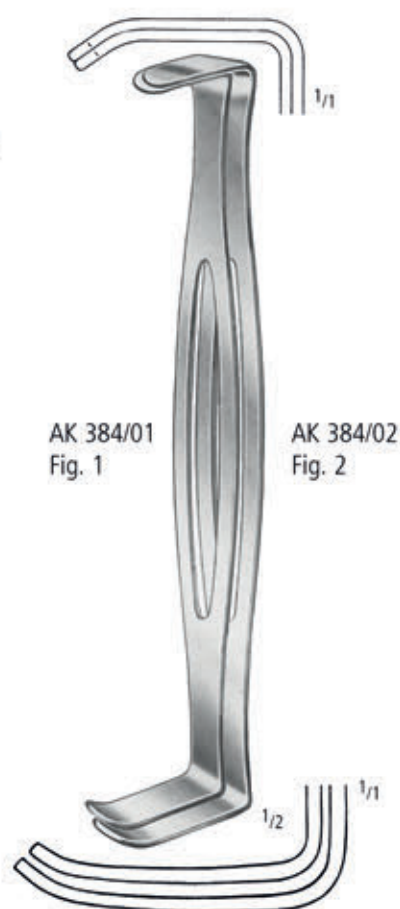

AK 384/01
Fig. 1

AK 384/02
Fig. 2

PARKER-LANGENBECK (U.S. Army)
AK 384/00 Fig. 1+2
21,0 cm/8 1/4"



AL 003/13
13,0 cm/5"



FRAZIER
10 Charr. AO 430/10



ALLIS 5:6
KD 055/15
15,0 cm/6"



GLOVER

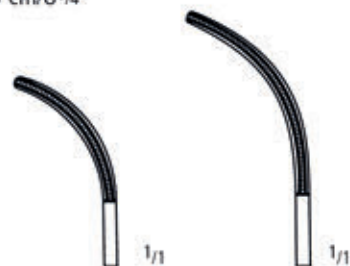

KK 371/06
5,5 cm/2 1/4"

KK 371/07
6,5 cm/2 1/2"



KK 371/09
8,5 cm/3 1/3"

cardiovascular basic

endarterectomy

thoracotomy

coronary bypass



PENFIELD
KS 638/01
17,5 cm/7"

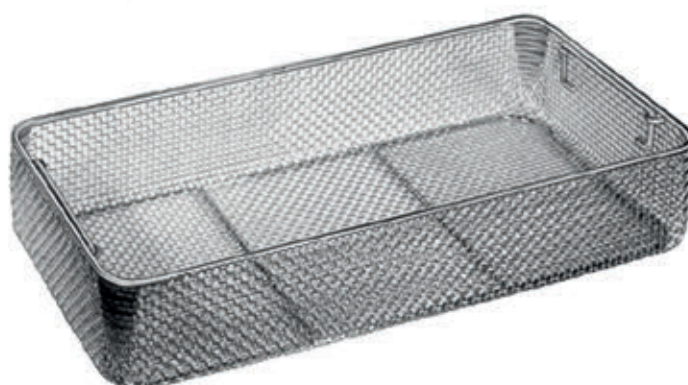

L(mm)	B(mm)	H(mm)	
540	255	70	SK 307/07

THORAKOTOMIE
THORACOTOMY
THORACOTOMIA
THORACOTOMIE
THORACOTOMIA

SET

ZS 941/01

Siebvorschlag - Suggested instrument set



THORAKOTOMIE THORACOTOMY THORACOTOMIA THORACOTOMIE THORACOTOMIA

ZS 941/01

Contents:

Qty

AA 151/12	HALSTED-MOSQUITO FCPS. CVD. 12.5 CM	12
AA 201/16	ROCHESTER-PEAN FCPS. CVD. 16.0 CM	12
AA 355/23	MIXTER FORCEPS CVD. 23.0 CM	2
AA 751/08	BACKHAUS TOWEL FORCEPS 8.0 CM	12
AB 200/25	POTTS-SMITH DRESSING FORCEPS STR. 25.0 CM	2
AB 210/25	POTTS-SMITH TISS. FCPS. STR. 1X2 TEETH 25.0 CM	1
AB 418/23	NELSON GRASPING FCPS. 23.0 CM	1
AC 111/28	METZENBAUM-NELSON SCS. CVD. BL/BL 28.0 CM	1
AE 130/27	MASSON NEEDLE HOLDER 27.0 CM	1
AK 150/04	VOLKMANN RETR. SHARP 4 PRONGS 21.5 CM	2
AK 230/02	LANGENBECK RETRACTOR 22.0 CM 30X14 MM	2
AK 337/90	DAVIDSON RETRACTOR 75X90 MM 16.0 CM	1
KA 550/53	MALLET 530G STEEL SOLID Ø 42/30 MM 24.0 CM	1
KA 677/15	LAMBOTTE RASPATORIES 15.0 MM	1
KA 681/17	DOYEN PERIOST. RASPATORY CVD. LEFT 17.0 CM	1
KA 683/17	DOYEN PERIOST. RASPATORY CVD. RIGHT 17.0 CM	1
KA 763/19	SEMB BONE HOLDING FCPS. W/O RATCHET 19.0 CM	1
KA 853/22	STILLE-LUER BONE RONGEURS CVD. 22.0 CM	1
KD 124/23	DUVAL INT. TISSUE FCPS. LARGE 23.0 CM	2
KK 018/34	BETHUNE RIB SHEARS 34.0 CM	1
KK 040/25	LEBSCHER CHISEL 25.0 CM	1
KK 092/02	FINOCCHIETTO RIB SPREADER 46X62X190 MM	1
KK 170/19	SELLORS RIB CONTRACTOR 19.0 CM	1
KK 180/32	ALLISON LUNG SPATULA 32.0 CM	1
KK 701/22	PRICE-THOMAS FORCEPS 22.0 CM	1
KK 703/02	SEMB BRONCHUS CLAMPS 22.0 CM	1
SK 307/07	WIRE BASKET, 540X255X70 MM	1

Sterilization Container KYE 200/51, if required.



HALSTED-MOSQUITO
AA 151/12
12,5 cm/5"

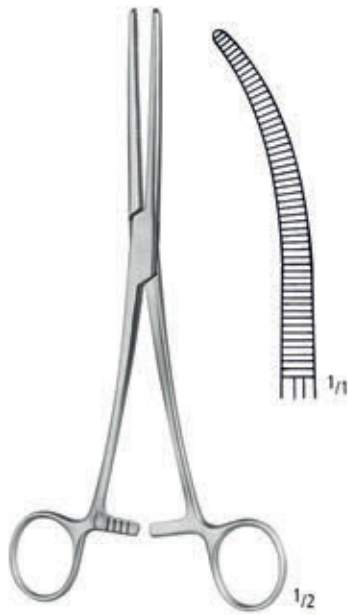

ROCHESTER-PEAN
AA 201/16
16,0 cm/6 1/4"



MIXTER
AA 355/23
23,0 cm/9"

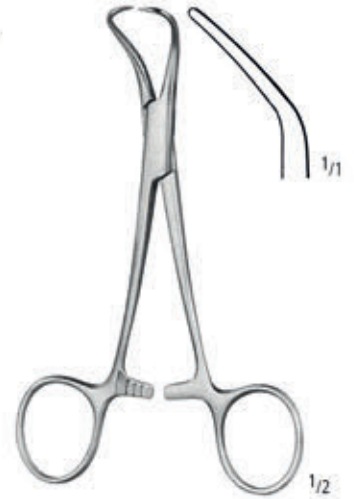

BACKHAUS
AA 751/08
8,0 cm/3"



POTTS-SMITH
AB 200/25
25,0 cm/10"



POTTS-SMITH 1:2
AB 210/25
25,0 cm/10"



NELSON
AB 418/23
23,0 cm/9"



METZENBAUM-NELSON
AC 111/28
28,0 cm/11"



MASSON
AE 130/27
27,0 cm/10 3/4"

cardiovascular basic

endarterectomy

thoracotomy

coronary bypass



VOLKMANN
AK 150/04
21,5 cm/8½"



LANGENBECK
AK 230/02
22,0 cm/8¾"



DAVIDSON
AK 337/90
16,0 cm/6¼"



Ø 42 mm Ø 30 mm
530 g
(19 oz.)

KA 550/53
24,0 cm/9½"



LAMBOTTE
KA 677/15
21,0 cm/8¼"



DOYEN
17,0 cm/6¾"

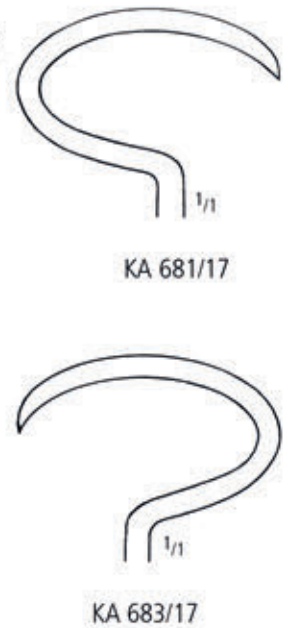

KA 681/17

KA 683/17



SEMB
KA 763/19
19,0 cm/7¹/₂"

STILLE-LUER
KA 853/22
22,0 cm/8³/₄"

DUVAL
KD 124/23
23,0 cm/9"

BETHUNE
KK 018/34
34,0 cm/13¹/₂"



LEBSCHE
KK 040/25
25,0 cm/10"



B 46 mm **H** 62 mm **C** 190 mm

FINOCCHIETTO
KK 092/02



SELLORS
KK 170/19
19,0 cm/7¹/₂"

cardiovascular basic

endarterectomy

thoracotomy

coronary bypass



ALLISON
KK 180/32
32,0 cm/12¹/₂"



PRICE-THOMAS
KK 701/22
22,0 cm/8³/₄"

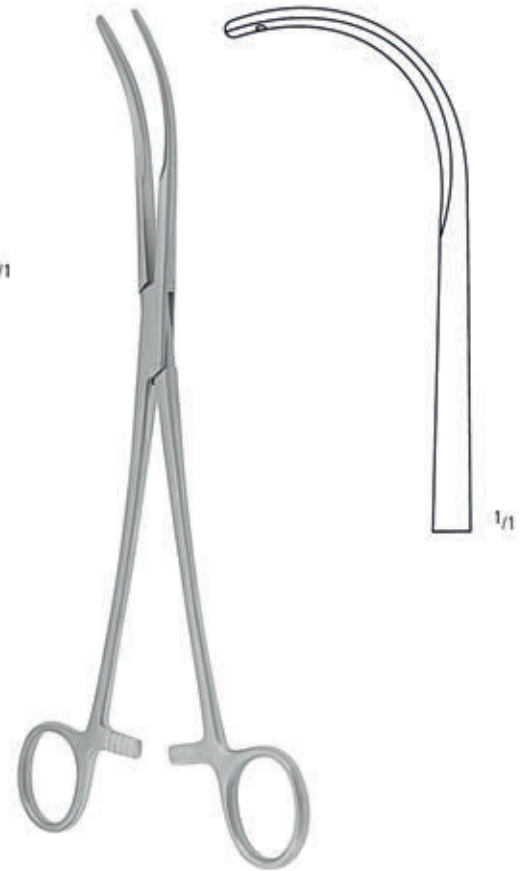

SEMB
KK 703/02
24,0 cm/9¹/₂"

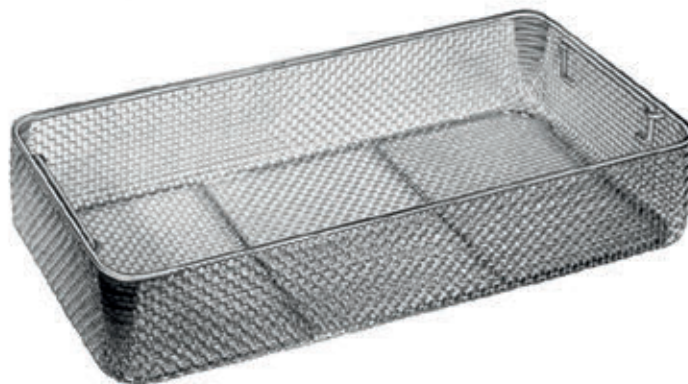

L(mm)	B(mm)	H(mm)	
540	255	70	SK 307/07

KORONAR ARTERIEN-BYPASS
CORONARY BYPASS
BYPASS CORONARIO
PONTAGE AORTO-CORONARIEN
BYPASS AORTO-CORONARICO

SET

ZS 941/60

Siebvorschlag - Suggested instrument set



ZS 941/60

Contents:

Qty

AA 114/10	HARTMANN FORCEPS STR. 10.0 CM	6
AA 115/10	HARTMANN FORCEPS CVD. 10.0 CM	6
AA 347/19	MIXTER-O'SHAUGNESSY ART. FCPS. CVD. 19.0 CM	2
AB 860/16	DE BAKEY ATRAUMA FCPS. STR. 1.5 MM 16.0 CM	2
AB 860/20	DE BAKEY ATRAUMA FCPS. STR. 1.5 MM 20.0 CM	2
AB 860/24	DE BAKEY ATRAUMA FCPS. STR. 1.5 MM 24.0 CM	2
AC 214/15	REYNOLDS DISS. SCISSORS STR. SHARP 15.0 CM	1
AC 224/01	HEGEMANN-DIETRICH VASC. SCS. 25° DEG 19.0 CM	1
AC 224/02	HEGEMANN-DIETRICH VASC. SCS. 45° DEG 19.0 CM	1
AC 224/03	HEGEMANN-DIETRICH VASC. SCS. 60° DEG 19.0 CM	1
AC 224/04	HEGEMANN-DIETRICH VASC. SCS. 90° DEG 19.0 CM	1
AC 224/05	HEGEMANN-DIETRICH VASC. SCS. 125° DEG 19.0 CM	1
AE 430/15	RYDER/FRENCH-EYE NEEDLE HOLDER TUC 15.0 CM	1
AE 430/18	RYDER/FRENCH-EYE NEEDLE HOLDER TUC 18.0 CM	1
AE 434/15	MICRO RYDER NEEDLE HOLDER TUC 15.0 CM	1
KC 130/01	BAKES GALL DUCT DILATOR FIG.1, 30.0 CM	1
KC 130/02	BAKES GALL DUCT DILATOR FIG.2, 30.0 CM	1
KC 130/03	BAKES GALL DUCT DILATOR FIG.3, 30.0 CM	1
KC 130/04	BAKES GALL DUCT DILATOR FIG.4, 30.0 CM	1
KC 130/05	BAKES GALL DUCT DILATOR FIG.5, 30.0 CM	1
KC 130/06	BAKES GALL DUCT DILATOR FIG.6, 30.0 CM	1
KC 130/07	BAKES GALL DUCT DILATOR FIG.7, 30.0 CM	1
KC 130/08	BAKES GALL DUCT DILATOR FIG.8, 30.0 CM	1
KC 130/09	BAKES GALL DUCT DILATOR FIG.9, 30.0 CM	1
KC 130/10	BAKES GALL DUCT DILATOR FIG.10, 30.0 CM	1
KC 130/11	BAKES GALL DUCT DILATOR FIG.11, 30.0 CM	1
KK 453/20	DE BAKEY FORCEPS 20.0 CM	1
SK 307/07	WIRE BASKET, 540X255X70 MM	1

Sterilization Container KYE 200/51, if required.



HARTMANN
AA 114/10
10,0 cm/4"



HARTMANN
AA 115/10
10,0 cm/4"

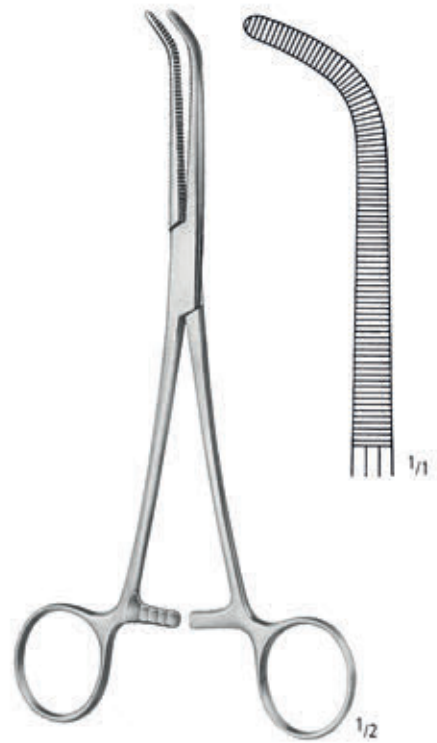

MIXTER-O'SHAUGHNESSY
AA 347/19
19,0 cm/7 1/2"

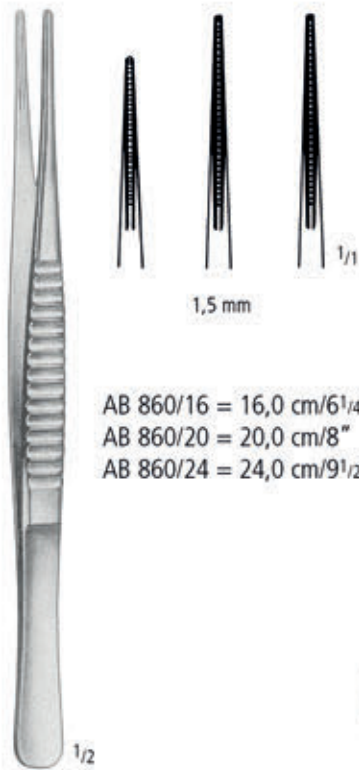

AB 860/16 = 16,0 cm/6 1/4"
AB 860/20 = 20,0 cm/8"
AB 860/24 = 24,0 cm/9 1/2"

DE BAKEY



REYNOLDS
AC 214/15
15,0 cm/6"

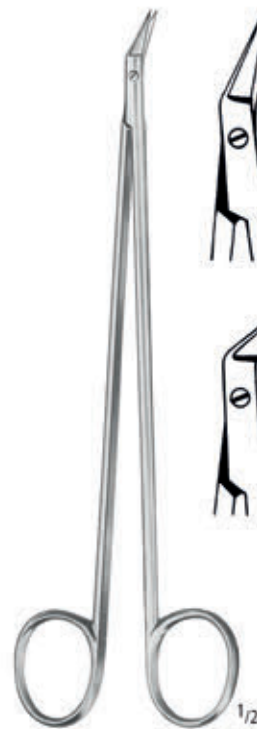

HEGEMANN-DIETRICH
19,0 cm/7 1/2"

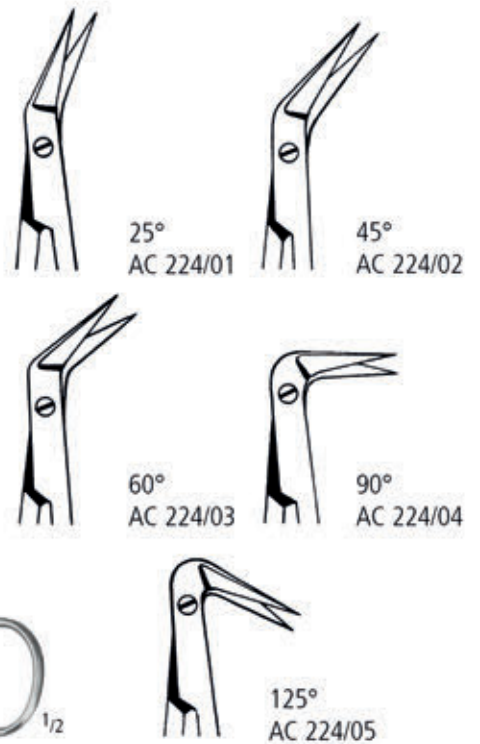

cardiovascular basic

endarterectomy

thoracotomy

coronary bypass

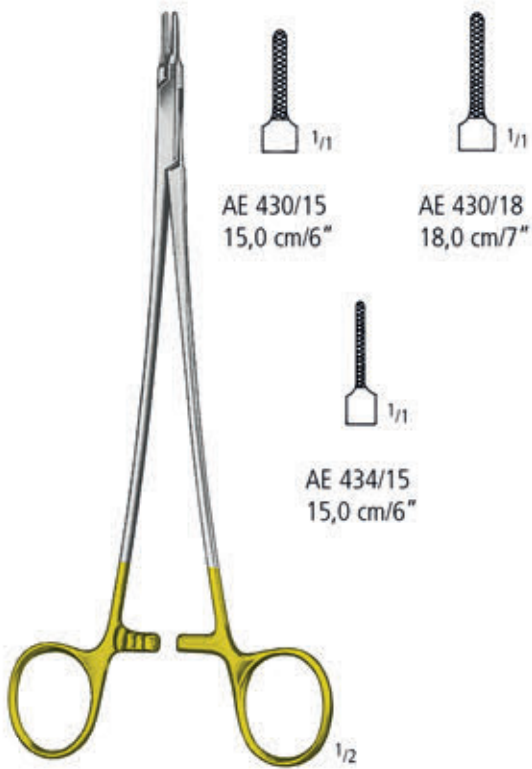

RYDER/FRENCH-EYE



DE BAKEY

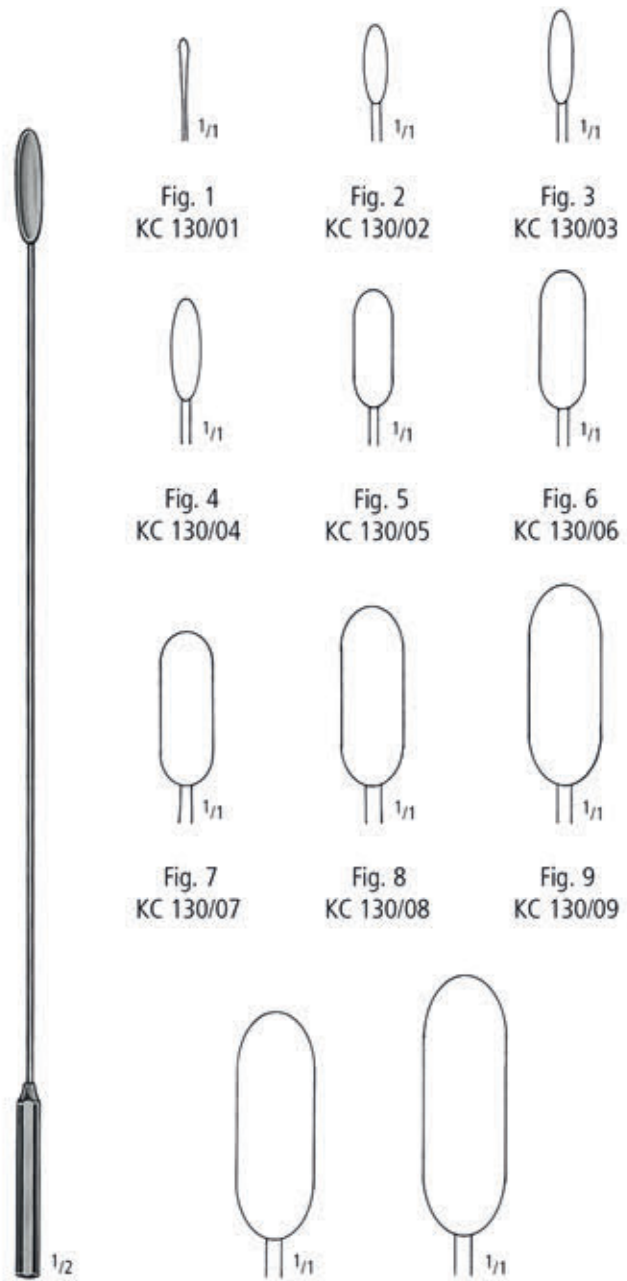

BAKES
30,0 cm/12"



L(mm)	B(mm)	H(mm)	
540	255	70	SK 307/07

KLEMMEN
HEMOSTATS
PINZAS HEMOSTATICAS
PINCES HEMOSTATIQUES
PINZE EMOSTATICHE

AA

nopa[®] instruments

Weitere Klemmen finden Sie in unserem Katalog „Allgemeine Chirurgie“ in Gruppe AA.

For further hemostats kindly refer to our catalogue „General Surgery“, section AA.

Para pinzas hemostaticas adicionales, por favor consulte nuestro catálogo de „Cirugía general“, grupo AA.

Pour des pinces hemostatiques supplémentaires, consultez notre catalogue „Chirurgie Generale“, section AA.

Per gli altri pinze emostatiche, consultare il nostro catalogo „Chirurgia Generale“, gruppo AA.





titan instruments

nopa[®] instruments

Besonderheit:

nopa Titan Instrumente bieten insbesondere in der Herz-Thorax-Chirurgie Vorteile gegenüber herkömmlichen Instrumenten. Titan ist ca. 45% leichter als rostfreier Edelstahl, weshalb Titan Instrumente weniger traumatisierend sind. Titan ist außerdem ein vollkommen korrosionsbeständiges und antimagnetisches Material. **nopa** Titan Instrumente bedeuten größtmöglichen Komfort für den Chirurgen.

Features:

nopa Titan Instruments provide especially in Cardiovascular surgery a significant advantage compared to other Instruments. Titan is approximately 45% lighter than stainless steel. For that reason, Titan Instruments are less traumatic. Besides that, Titan is a completely stainless and anti-magnetic material. **nopa** Titan Instruments are the most comfortable choice for the Cardiovascular surgeon.

AA 114/10 T	HARTMANN FORCEPS STR. 10.0 CM
AA 115/10 T	HARTMANN FORCEPS CVD. 10.0 CM
AA 130/12 T	MICRO-MOSQUITO FORCEPS STR. 12.0 CM
AA 131/12 T	MICRO-MOSQUITO FORCEPS CVD. 12.0 CM
AA 132/12 T	MICRO-MOSQUITO ARTERY FCPS. 1X2 STR. 12.0 CM
AA 133/12 T	MICRO-MOSQUITO ARTERY FCPS. 1X2 CVD. 12.0 CM
AA 150/12 T	HALSTED-MOSQUITO FORCEPS STR. 12.5 CM
AA 151/12 T	HALSTED-MOSQUITO FORCEPS CVD. 12.5 CM
AA 152/12 T	HALSTED-MOSQUITO ARTERY FCPS. 1X2 STR. 12.5 CM
AA 153/12 T	HALSTED-MOSQUITO FCPS. 1X2 CVD. 12.5 CM
AA 160/15 T	LERICHE ARTERY FCPS. STR. 15.0 CM
AA 161/15 T	LERICHE ARTERY CVD. 15.0 CM
AA 162/15 T	LERICHE ARTERY FCPS. STR. 1X2 T. 15.0 CM
AA 163/15 T	LERICHE ARTERY FCPS. CVD. 1X2 T. 15.0 CM
AA 330/24 T	CRAFOORD ARTERY FORCEPS CVD. 24.0 CM



Gewebefasszängchen
Tissue Seizing Forceps
Pinzas para coger tejidos
Pincers pour saisir le tissu
Pinze per afferrare tessuti

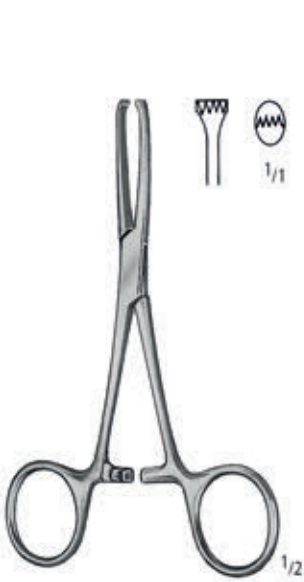

ALLIS-BABY 4:5
KD 050/12
12,5 cm/5"



ALLIS 4:5
KD 054/15
15,0 cm/6"



ALLIS 5:6
15,0 cm/6" KD 055/15
19,0 cm/7 1/2" KD 055/19
25,0 cm/10" KD 055/25



ALLIS

KD 058/16
16,0 cm/6 1/4"

KD 058/20
20,0 cm/8"

KD 058/25
25,0 cm/10"

KD 058/30
30,0 cm/12"



ALLIS-ADAIR 10:11
KD 060/15
15,0 cm/6"

Darmfasszangen
Tissue Seizing Forceps
Pinzas para coger intestinos
Pincers pour saisir l'intestin
Pinze per afferrare l'intestino



BABCOCK
16,0 cm/6 1/4" KD 100/16
20,0 cm/8" KD 100/20



BABCOCK

KD 111/16
16,0 cm/6 1/4"



KD 111/18
18,0 cm/7"



KD 111/20
20,0 cm/8"



KD 111/24
24,0 cm/9 1/2"

ATRAU
nopa®

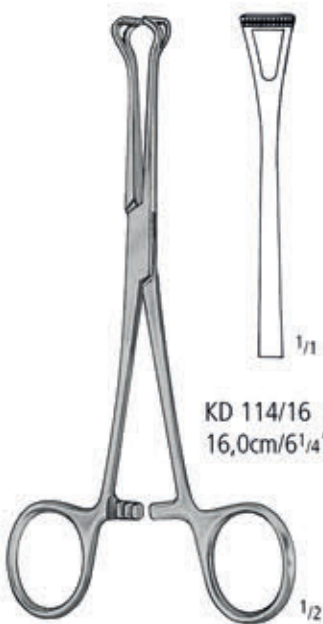

BABCOCK

KD 114/16
16,0cm/6 1/4"



KD 114/20
20,0 cm/8"



DUVAL
KD 120/20
20,0 cm/8"



KD 122/18
18,0 cm/7"
KD 122/20
20,0 cm/8"

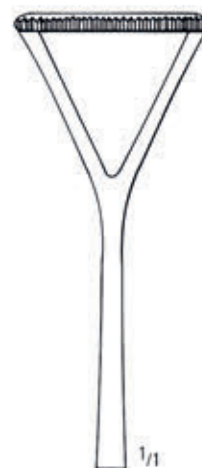

KD 124/20
20,0 cm/8"
KD 124/23
23,0 cm/9"

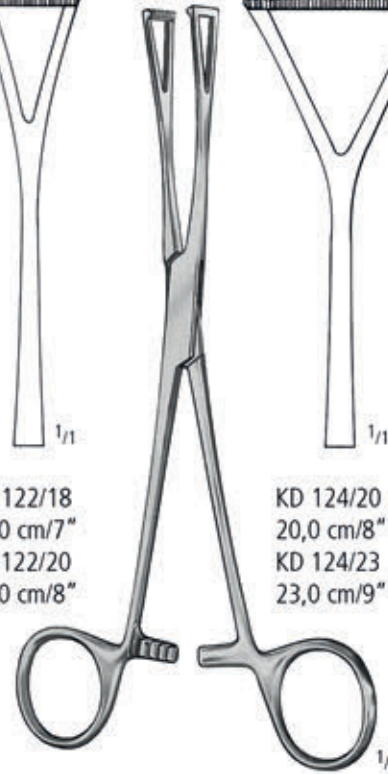

DUVAL

AA

AB

AC

AD

AE

AF

AK

AL

AO

KA

KK

X

Bulldogklemmen
Bulldog Clamps
Clamps Bulldog
Clamps Bulldog
Pinze Bulldog

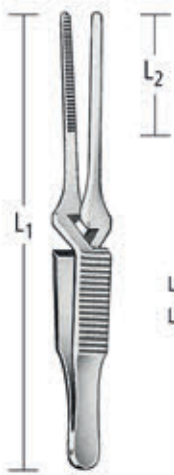

AA 050/01	AA 050/02	AA 050/03	AA 051/01	AA 051/02	AA 051/03
L ₁ 50 mm	50 mm	60 mm	50 mm	50 mm	60 mm
L ₂ 8 mm	12 mm	20 mm	8 mm	12 mm	20 mm

3 gr. Gewicht
50 gr. Druck
Gewicht Pressure
Weight Pression
Peso Presión
Poids Pression
Peso Pressione

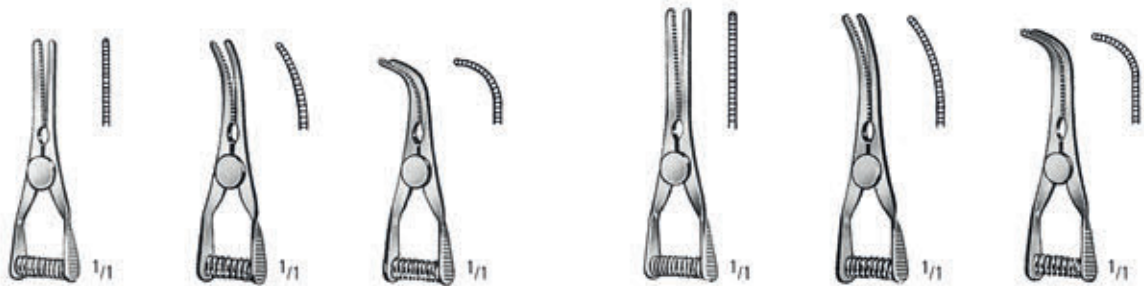

**VENA
ARTERIA**

AA 052/01
AA 053/01

TITAN 30 mm

AA 052/02
AA 053/02

AA 052/03
AA 053/03

AA 054/01
AA 055/01

TITAN 35 mm

AA 054/02
AA 055/02

AA 054/03
AA 055/03

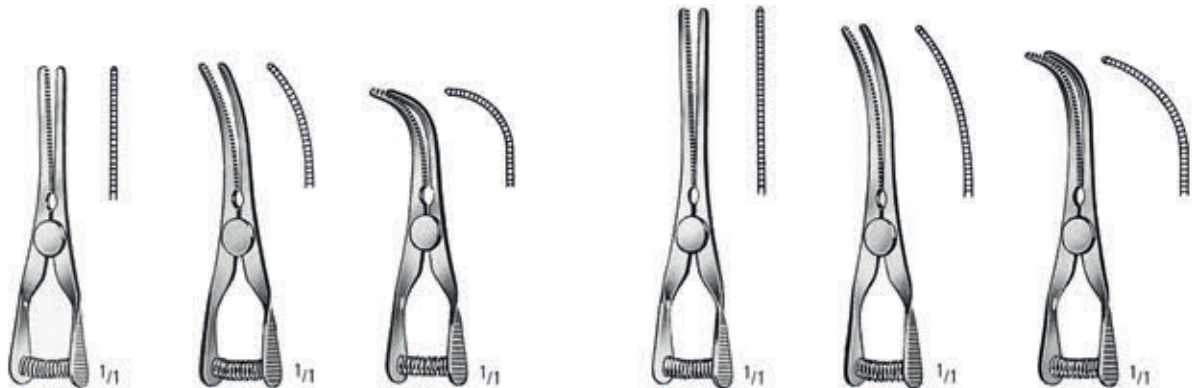

**VENA
ARTERIA**

AA 056/01
AA 057/01

TITAN 40 mm

AA 056/02
AA 057/02

AA 056/03
AA 057/03

AA 058/01
AA 059/01

TITAN 50 mm

AA 058/02
AA 059/02

AA 058/03
AA 059/03

Bulldogklemmen, Anlegezange
 Bulldog Clamps, Setting Forceps
 Clamps Bulldog, Pinza para poner
 Clamps Bulldog, Pince à poser
 Pinze Bulldog, Pinza per posizionare

AA
 AB
 AC
 AD
 AE
 AF
 AK
 AL
 AO
 KA
 KK
 X



DIEFFENBACH



- AA 060/03
3,5 cm/1 1/2"
- AA 060/05
5,0 cm/2"
- AA 060/06
6,0 cm/2 1/2"
- AA 061/03
3,5 cm/1 1/2"
- AA 061/05
5,0 cm/2"
- AA 061/06
6,0 cm/2 1/2"



JOHNS-HOPKINS
 AA 069/24
 24,5 cm/9 3/4"



JOHNS-HOPKINS

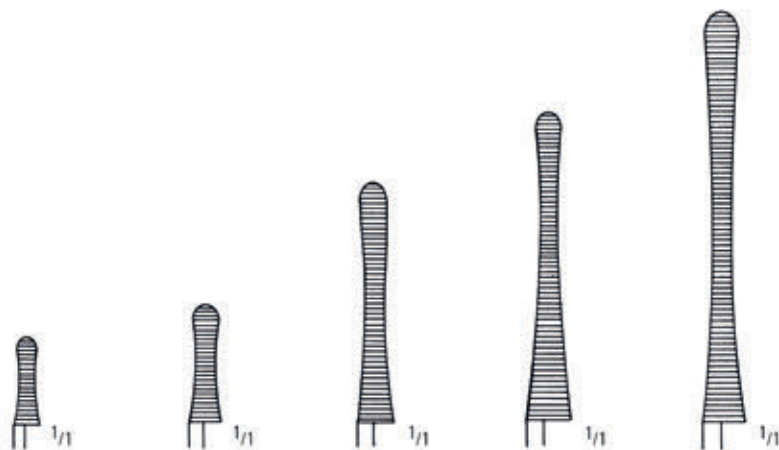

- AA 070/04
4,0 cm/1 1/2"
- AA 070/05
5,0 cm/2"
- AA 070/06
6,5 cm/2 1/2"
- AA 070/07
7,5 cm/3"
- AA 070/09
9,0 cm/3 1/2"

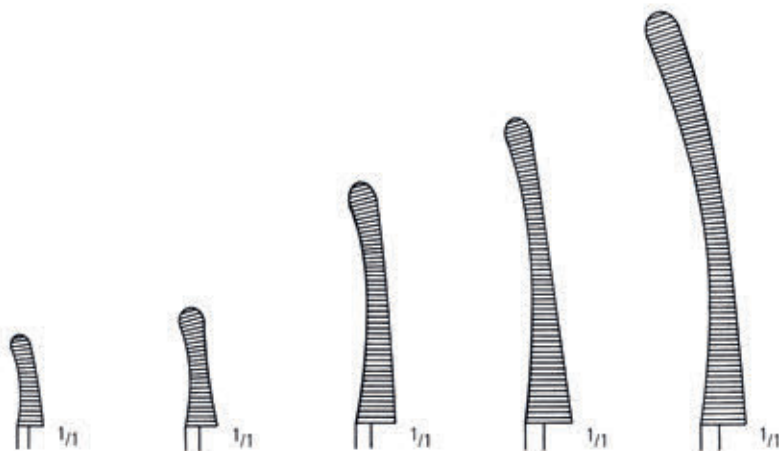

- AA 071/04
4,0 cm/1 1/2"
- AA 071/05
5,0 cm/2"
- AA 071/06
6,5 cm/2 1/2"
- AA 071/07
7,5 cm/3"
- AA 071/09
9,0 cm/3 1/2"

Arterienklemmen
Artery Forceps
Pinzas hemostáticas
Pinces hémostatiques
Pinze emostatiche



CHAPUT
AA 072/02
13,0 cm/5"



TUFFIER
AA 072/04
13,0 cm/5"

Arterienklemmen
 Artery Forceps
 Pinzas hemostáticas
 Pincas hémostatiques
 Pinze emostatiche

AA
 AB
 AC
 AD
 AE
 AF
 AG
 AH
 AI
 AJ
 AK
 AL
 AO
 AP
 AQ
 AR
 AS
 AT
 AU
 AV
 AW
 AX

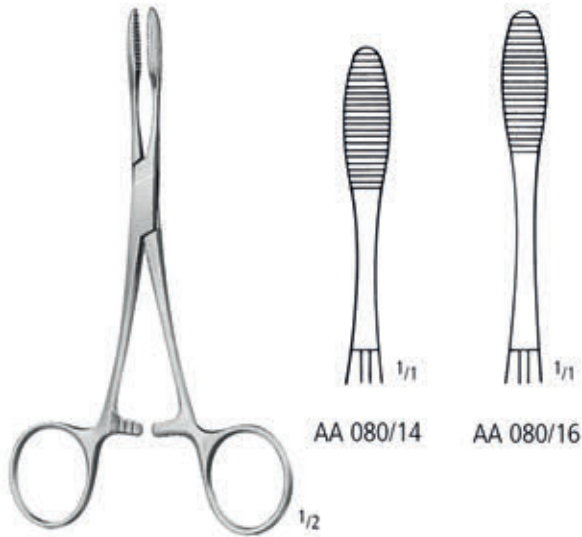

PEAN
 14,0 cm/5¹/₂" AA 080/14
 16,0 cm/6¹/₄" AA 080/16



KROENLEIN
 AA 082/13
 13,0 cm/5"

Arterienklemmen
 Artery Forceps
 Pinzas hemostáticas
 Pincas hémostatiques
 Pinze emostatiche



SPENCER-WELLS



AA 110/13
13,0 cm/5"

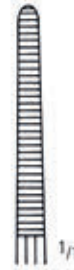

AA 110/14
14,0 cm/5½"



AA 110/15
15,5 cm/6"



AA 110/18
18,0 cm/7"



AA 110/20
20,0 cm/8"



AA 111/13
13,0 cm/5"



AA 111/14
14,0 cm/5½"



AA 111/15
15,5 cm/6"



AA 111/18
18,0 cm/7"



AA 111/20
20,0 cm/8"



HARTMANN
AA 114/10
10,0 cm/4"



HARTMANN
AA 115/10
10,0 cm/4"



CARREL
AA 116/08
8,5 cm/3½"



TERRIER 1:2
AA 118/08
8,5 cm/3½"

Feine Arterienklemmen
 Fine Artery Forceps
 Pinzas hemostáticas finas
 Pincas hémostatiques fines
 Pinze emostatiche fine

AA
 AB
 AC
 AD
 AE
 AF
 AK
 AL
 AO
 KA
 KK
 X

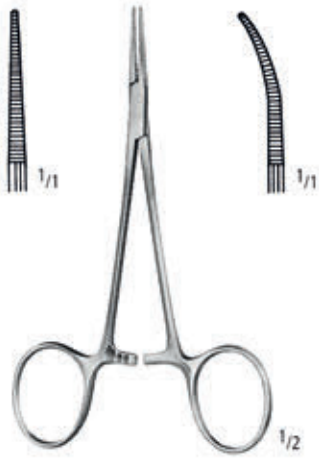

MICRO-MOSQUITO
 AA 130/10 AA 131/10
 AA 130/12 AA 131/12

10,0 cm/4"
 12,0 cm/4³/₄"

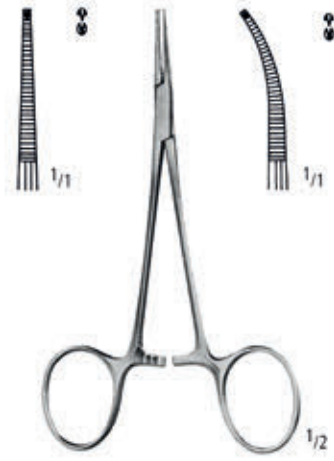

MICRO-MOSQUITO 1:2
 AA 132/10 AA 133/10
 AA 132/12 AA 133/12

WILLIAM STEWART HALSTED
 was professor of surgery in the Johns Hopkins University. In 1890 he had bronze casts made of his own hands. On these casts the first surgical rubber gloves were moulded.



HALSTED-MOSQUITO
 AA 150/12 AA 151/12
 AA 150/14 AA 151/14

12,5 cm/5"
 14,0 cm/5¹/₂"

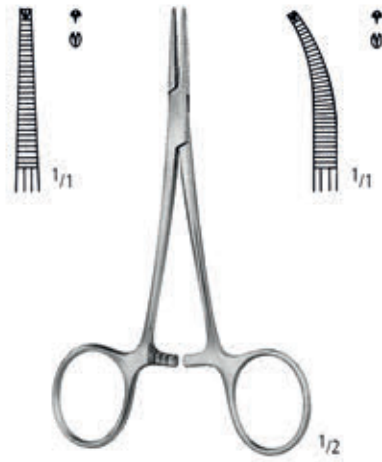

HALSTED-MOSQUITO 1:2
 AA 152/12 AA 153/12
 AA 152/14 AA 153/14

Arterienklemmen
 Artery Forceps
 Pinzas hemostáticas
 Pincés hémostatiques
 Pinze emostatiche

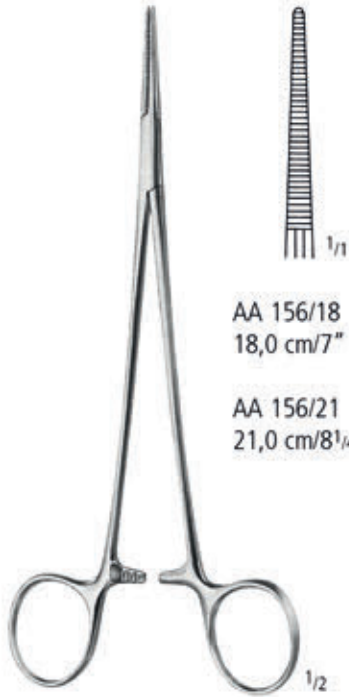

AA 156/18
 18,0 cm/7"

AA 156/21
 21,0 cm/8¹/₄"

HALSTED



AA 157/18
 18,0 cm/7"

AA 157/21
 21,0 cm/8¹/₄"

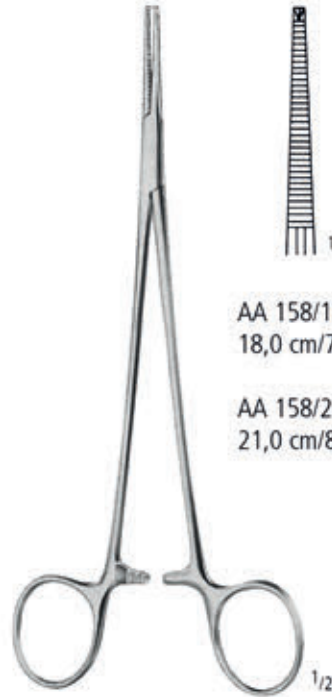

AA 158/18
 18,0 cm/7"

AA 158/21
 21,0 cm/8¹/₄"

HALSTED 1:2



AA 159/18
 18,0 cm/7"

AA 159/21
 21,0 cm/8¹/₄"

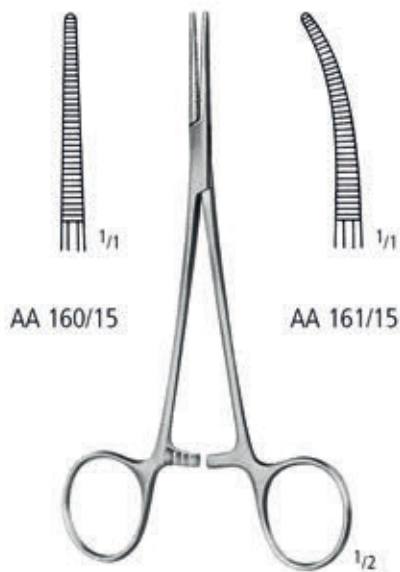

AA 160/15

AA 161/15

LERICHE
 15,0 cm/6"

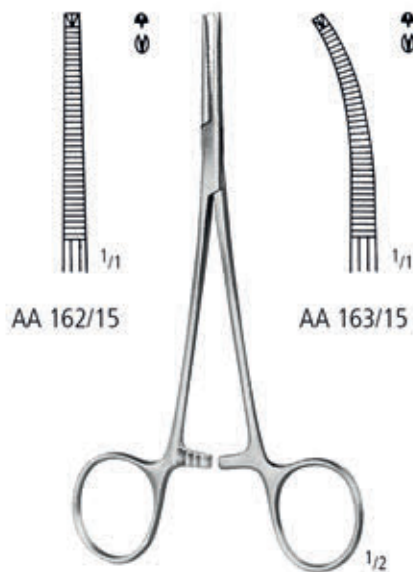

AA 162/15

AA 163/15

LERICHE 1:2
 15,0 cm/6"

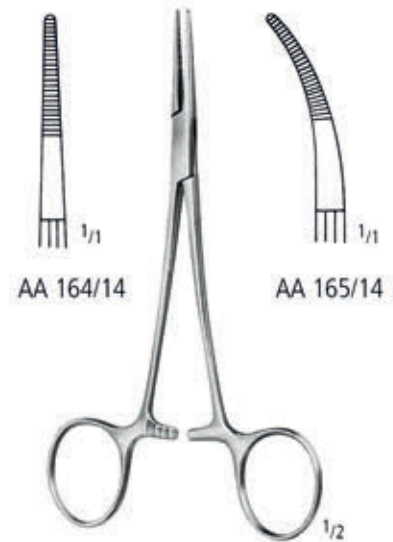

AA 164/14

AA 165/14

PROVIDENCE-HOSPITAL
 14,0 cm/5¹/₂"

Arterienklemmen
Artery Forceps
Pinzas hemostáticas
Pincés hémostatiques
Pinze emostatiche

AA

AB

AC

AD

AE

AF

AK

AL

AO

KA

KK

X

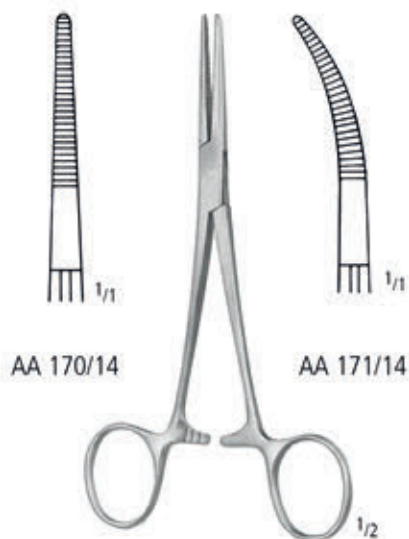

KELLY
14,0 cm/5 1/2"

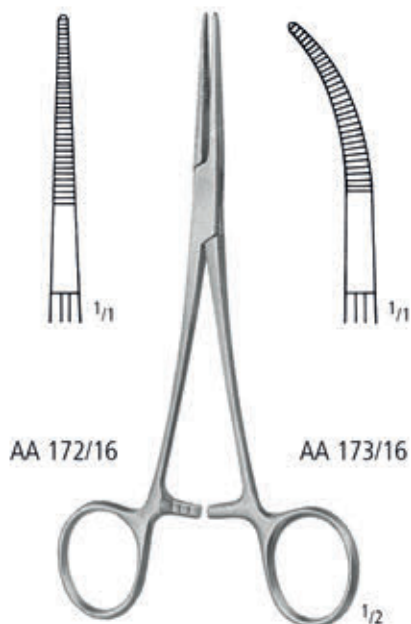

KELLY-RANKIN
16,0 cm/6 1/4"

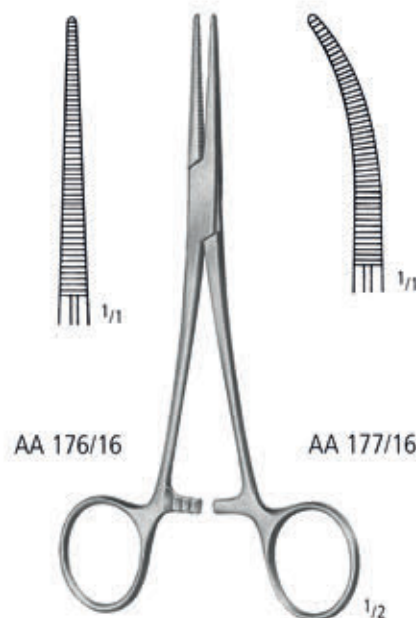

COLLER
AA 176/14 14,0 cm/5 1/2" AA 177/14
AA 176/16 16,0 cm/6 1/4" AA 177/16

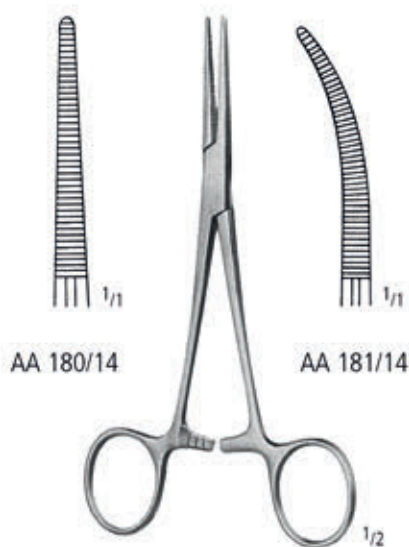

CRILE
14,0 cm/5 1/2"

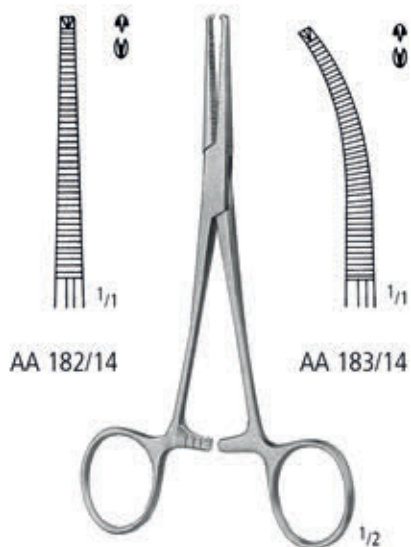

CRILE 1:2
14,0 cm/5 1/2"

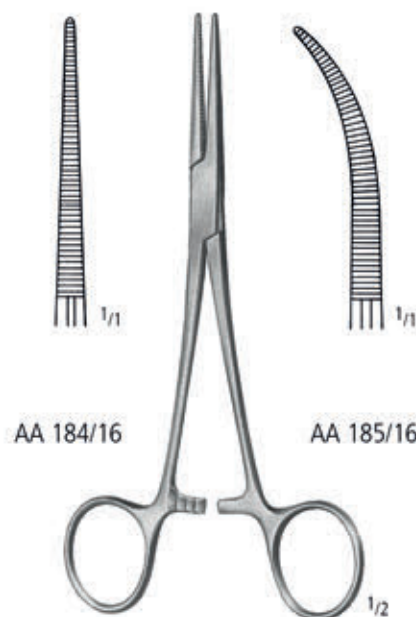

CRILE-RANKIN
16,0 cm/6 1/4"

Arterienklemmen
 Artery Forceps
 Pinzas hemostáticas
 Pincas hémostatiques
 Pinze emostatiche



ROCHESTER-PEAN

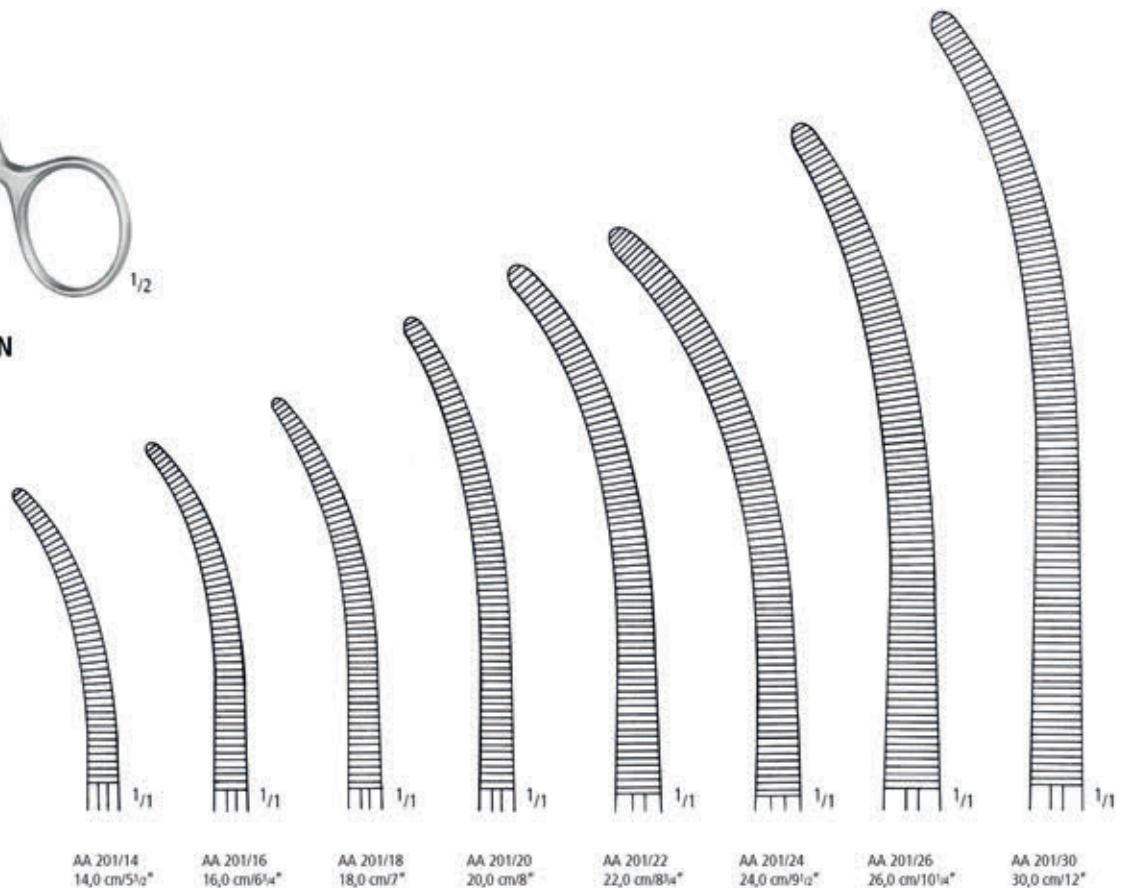
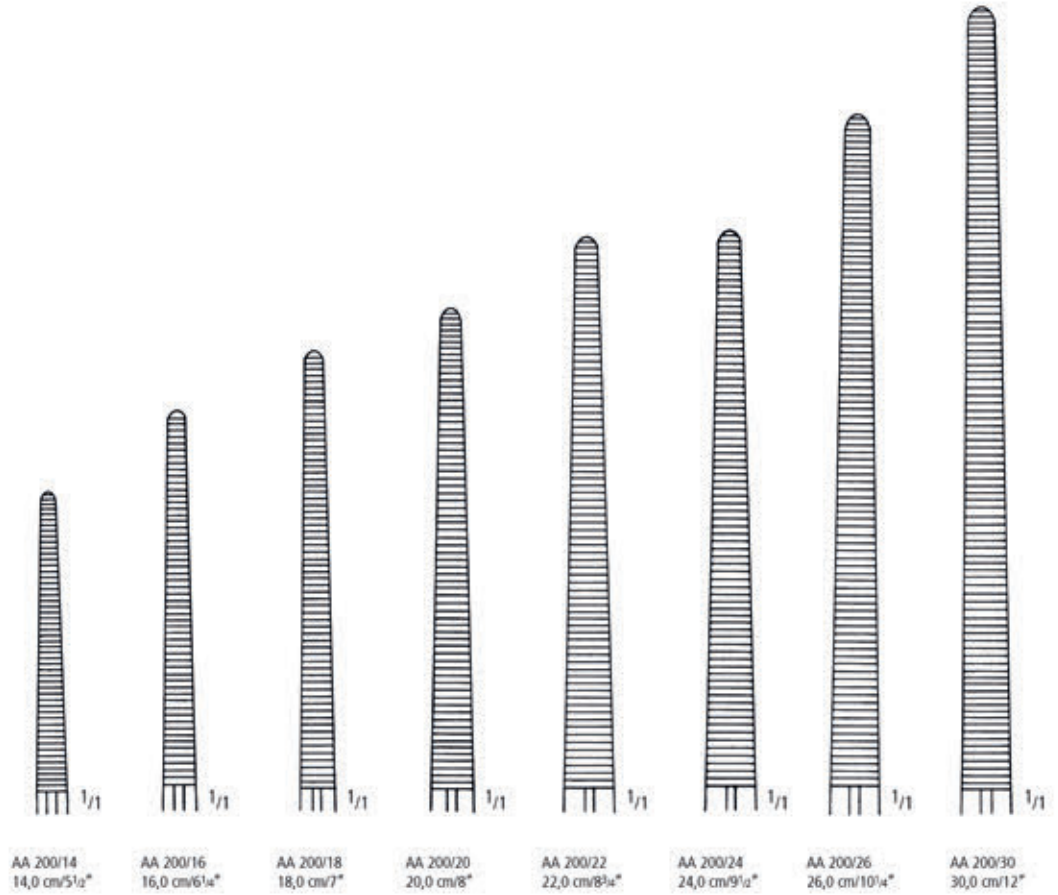

Arterienklemmen
 Artery Forceps
 Pinzas hemostáticas
 Pincas hémostatiques
 Pinze emostatiche

AA
 AB
 AC
 AD
 AE
 AF
 AG
 AH
 AI
 AJ
 AK
 AL
 AM
 AN
 AO
 AP
 AQ
 AR
 AS
 AT
 AU
 AV
 AW
 AX
 AY
 AZ



OCHSNER-KOCHER 1:2

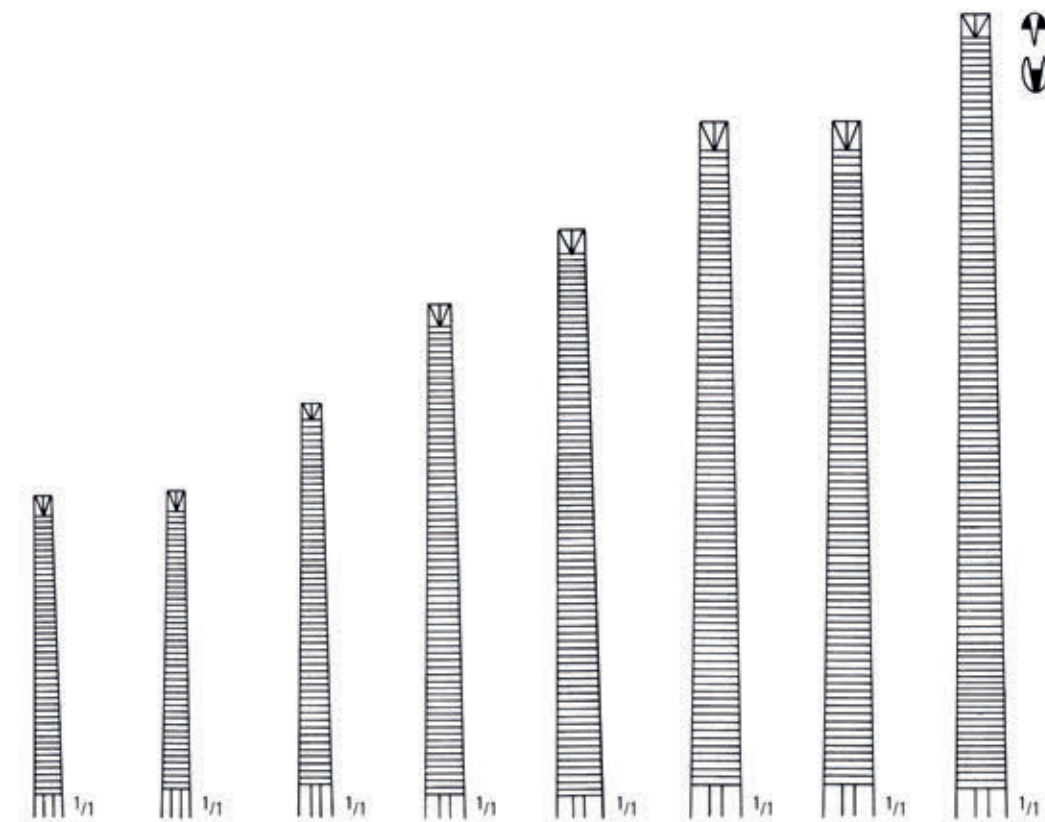

AA 210/14 14,0 cm/5½"	AA 210/16 16,0 cm/6¼"	AA 210/18 18,0 cm/7"	AA 210/20 20,0 cm/8"	AA 210/22 22,0 cm/8¾"	AA 210/24 24,0 cm/9½"	AA 210/26 26,0 cm/10¼"	AA 210/30 30,0 cm/12"
--------------------------	--------------------------	-------------------------	-------------------------	--------------------------	--------------------------	---------------------------	--------------------------

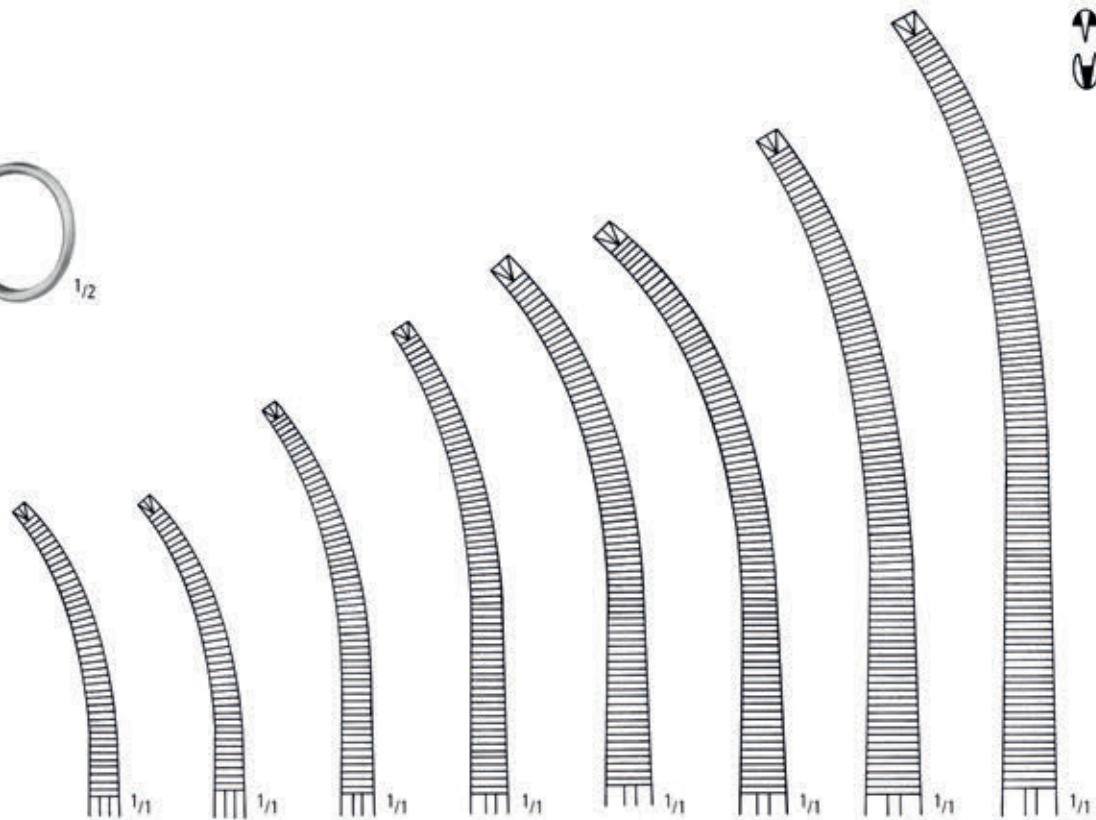

AA 211/14 14,0 cm/5½"	AA 211/16 16,0 cm/6¼"	AA 211/18 18,0 cm/7"	AA 211/20 20,0 cm/8"	AA 211/22 22,0 cm/8¾"	AA 211/24 24,0 cm/9½"	AA 211/26 26,0 cm/10¼"	AA 211/30 30,0 cm/12"
--------------------------	--------------------------	-------------------------	-------------------------	--------------------------	--------------------------	---------------------------	--------------------------

Grazile Arterienklemmen
 Delicate Artery Forceps
 Pinzas hemostáticas delgadas
 Pincas hémostatiques graciles
 Pinze emostatiche delicate

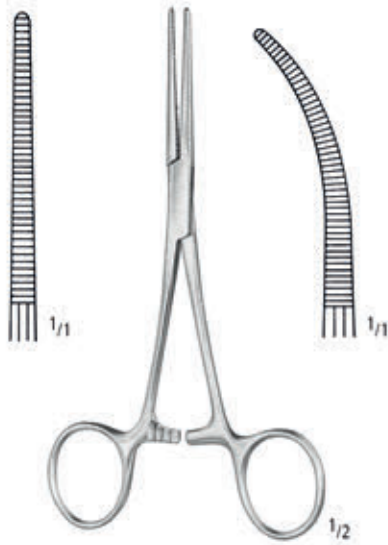

PEAN - DELICATE

- | | |
|-----------|-----------|
| AA 214/13 | AA 215/13 |
| AA 214/14 | AA 215/14 |
| AA 214/16 | AA 215/16 |

- | |
|-------------|
| 13,0 cm/5" |
| 14,0 cm/5½" |
| 16,0 cm/6¼" |

JULES PEAN, born 1830, died 1898, was the most important French gynecological surgeon of his time. He studied at Paris 1860. 1864 Pean was the first surgeon in Paris to perform an ovariectomy. By the use of Pean pins he introduced forceps pressure for control of hemorrhage, thus he invented the most used surgical instrument, next to the scalpel.

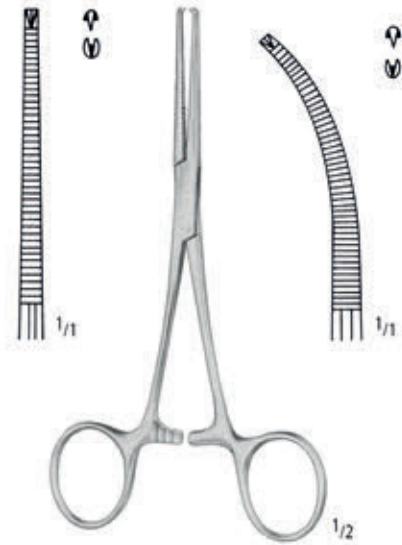

KOCHER 1:2 - DELICATE

- | | |
|-----------|-----------|
| AA 216/13 | AA 217/13 |
| AA 216/14 | AA 217/14 |
| AA 216/16 | AA 217/16 |

ALBERT J. OCHSNER, born 1858, died 1925. He devoted much time to attending and participating in medical discussions and was member of all leading societies in his fields.

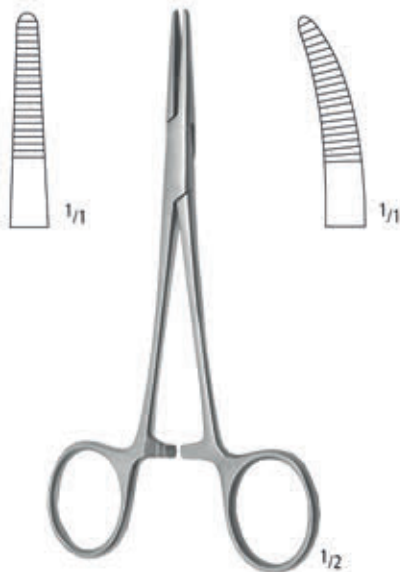

CAIRNS

- | | | |
|-----------|------------|-----------|
| AA 218/15 | 15,0 cm/6" | AA 219/15 |
|-----------|------------|-----------|



DUNHILL

- | | |
|-----------|------------|
| AA 220/13 | 13,0 cm/5" |
|-----------|------------|

Arterienklemmen, Präparier- und Ligaturklemmen
 Artery Forceps, Dissecting and Ligature Forceps
 Pinzas hemostáticas, Pinzas para preparaciones y ligaduras
 Pincas hémostatiques, Pincas à disséquer et à ligatures
 Pinze emostatiche, Pinze per preparazioni e legature

AA

AB

AC

AD

AE

AF

AK

AL

AO

KA

KK

X



OVERHOLT-GEISSENDOERFER

21,0 cm/8¹/₄"
 27,0 cm/10³/₄"



Fig. 1 1/1

AA 221/01
 AA 223/01



Fig. 2 1/1

AA 221/02
 AA 223/02



Fig. 3 1/1

AA 221/03
 AA 223/03

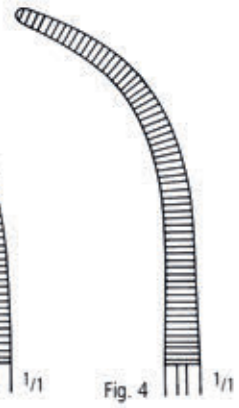

Fig. 4 1/1

AA 221/04
 AA 223/04



Fig. 5 1/1

AA 221/05
 AA 223/05

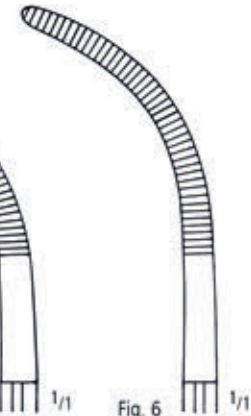

Fig. 6 1/1

AA 221/06
 AA 223/06



Fig. 7 1/1

AA 221/07
 AA 223/07

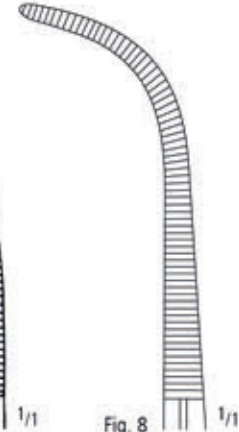

Fig. 8 1/1

AA 224/08

21,0 cm/8¹/₄"
 27,0 cm/10³/₄"
 29,5 cm/11¹/₂"



BABY-OVERHOLT

AA 225/13
 13,5 cm/5¹/₄"

Präparier- und Ligaturklemmen
 Dissecting and Ligature Forceps
 Pinzas para preparaciones y ligaduras
 Pincès à disséquer et à ligatures
 Pinze per preparazioni e legature



OVERHOLT
 AA 229/01
 18,5 cm/7¹/₃"



OVERHOLT
 AA 229/02
 20,5 cm/8"



OVERHOLT
 AA 229/03
 21,0 cm/8¹/₄"



OVERHOLT
 AA 229/04
 21,5 cm/8¹/₂"

S-förmig gebogen
 S-shaped
 curvas en S
 courbes en S
 curve in S



Arterienklemmen, Präparier- und Ligaturklemmen
 Artery Forceps, Dissecting and Ligature Forceps
 Pinzas hemostáticas, Pinzas para preparaciones y ligaduras
 Pincès hémostatiques, Pincès à disséquer et à ligatures
 Pinze emostatiche, Pinze per preparazioni e legature

AA
 AB
 AC
 AD
 AE
 AF
 AK
 AL
 AO
 KA
 KK
 X

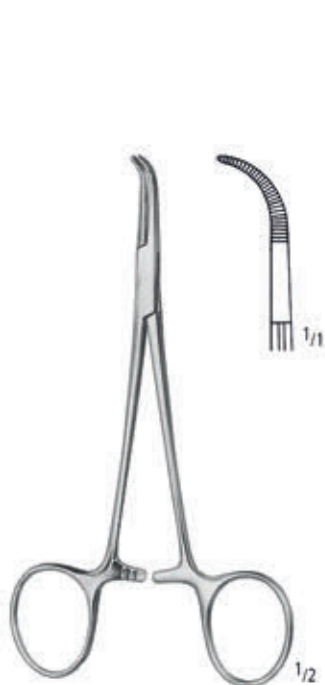

BABY-ADSON
 AA 235/14
 14,0 cm/5 1/2"

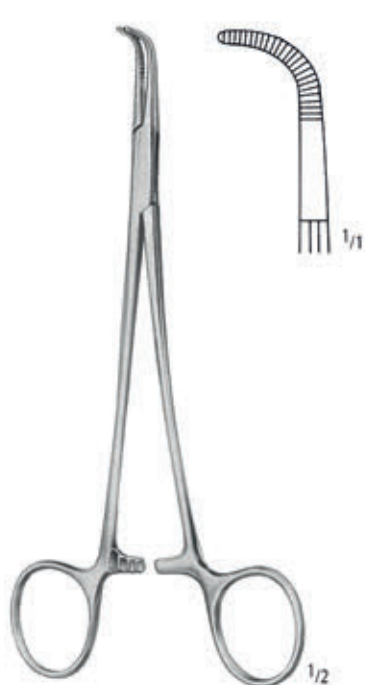

BABY-ADSON
 AA 237/18
 18,0 cm/7"

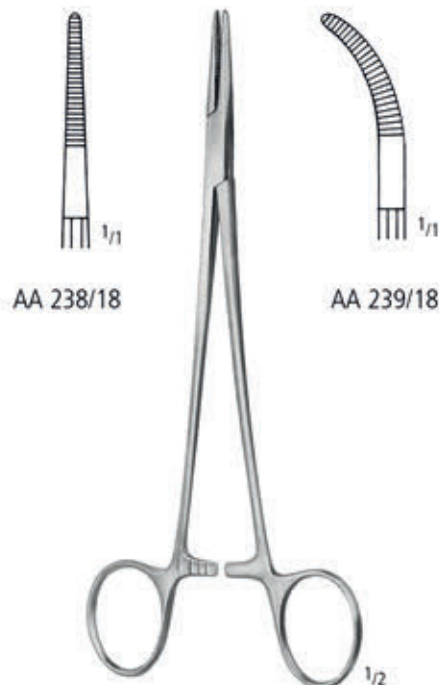

ADSON
 18,5 cm/7 1/3"

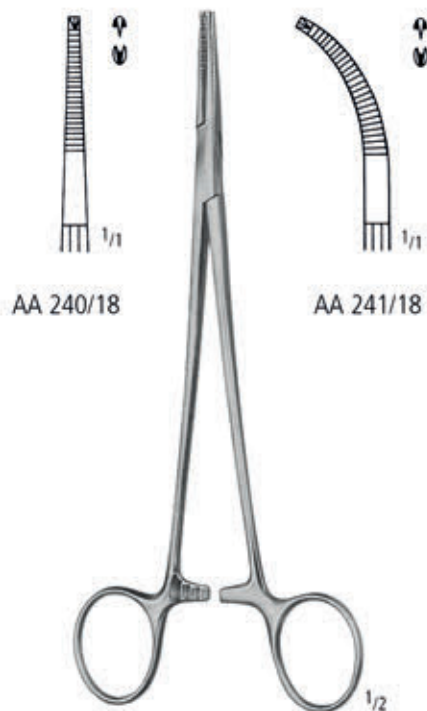

ADSON 1:2
 18,5 cm/7 1/3"



MEEKER

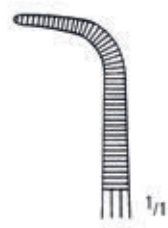

AA 251/18
 18,0 cm/7"

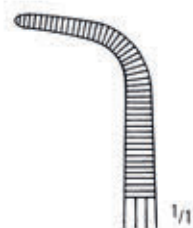

AA 251/28
 28,0 cm/11"

Arterienklemmen
 Artery Forceps
 Pinzas hemostáticas
 Pincas hémostatiques
 Pinze emostatiche



DIXON-LOVELACE
 AA 286/15
 15,5 cm/6"



DIXON-LOVELACE 1:2
 AA 288/15
 15,5 cm/6"

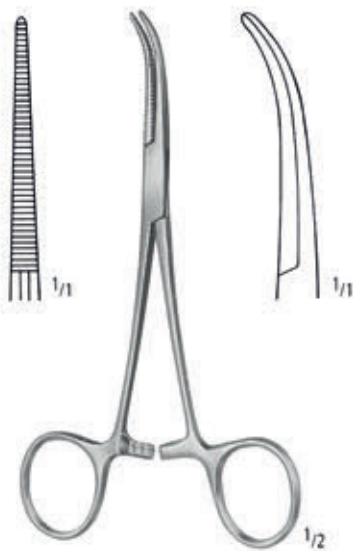

DANDY
 AA 291/14
 14,0 cm/5 1/2"

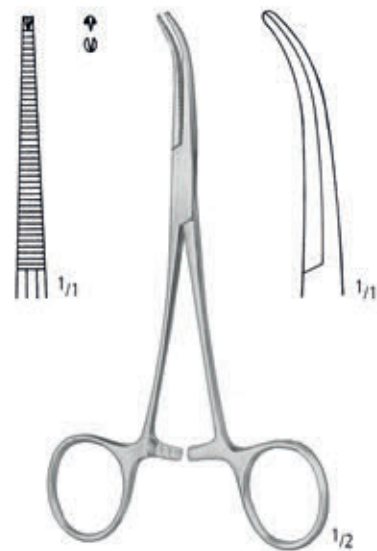

DANDY 1:2
 AA 293/14
 14,0 cm/5 1/2"

Arterienklemmen, Tonsillenklemmen
 Artery Forceps, Tonsil Hemostatic Forceps
 Pinzas hemostáticas, pinzas hemostáticas para amígdalas
 Pincés hémostatiques, pincés hémostatiques pour amygdales
 Pinze emostatiche, pinze emostatiche per tonsille

AA
 AB
 AC
 AD
 AE
 AF
 AG
 AH
 AI
 AJ
 AK
 AL
 AO
 AP
 AQ
 AR
 AS
 AT
 AU
 AV
 AW
 AX
 AY
 AZ

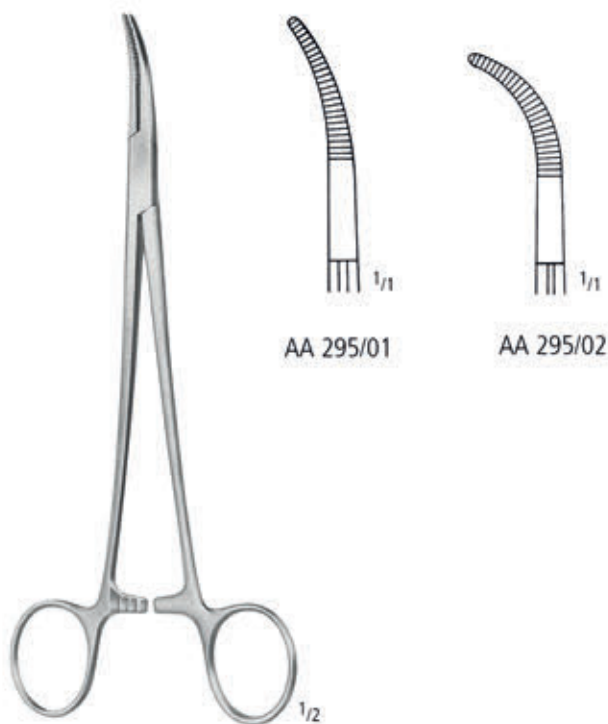

AA 295/01

AA 295/02

SCHNIDT-SAWTELL
 19,0 cm/7 1/2"

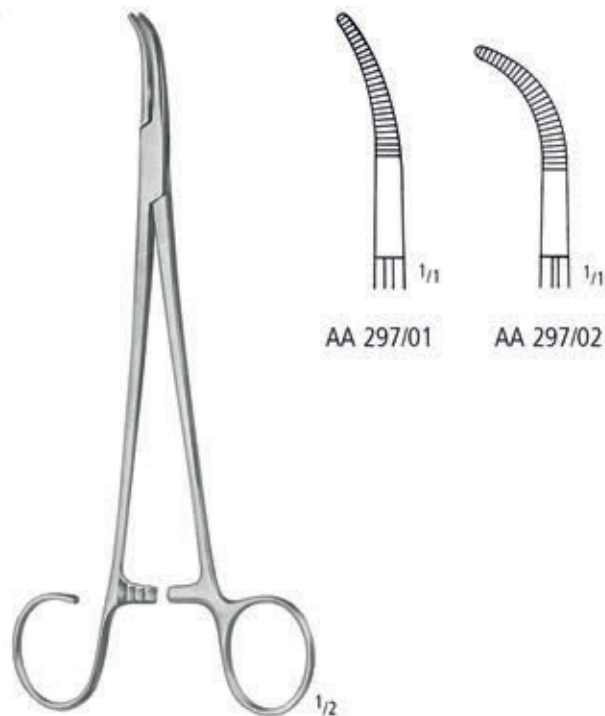

AA 297/01

AA 297/02

SCHNIDT-SAWTELL
 19,0 cm/7 1/2"

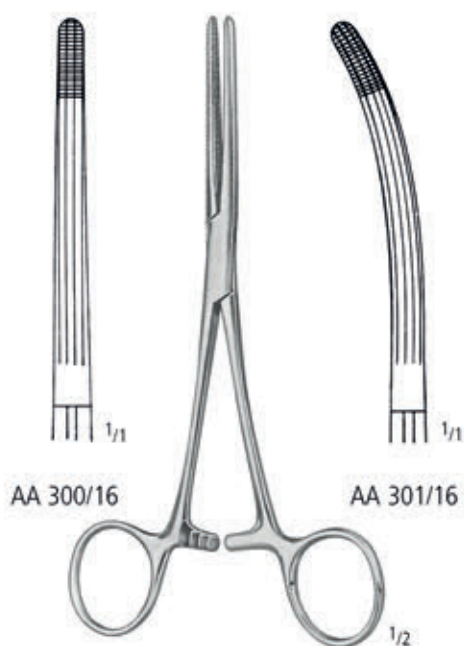

AA 300/16

AA 301/16

ROCHESTER-CARMALT

AA 300/16
 AA 300/20

16,0 cm/6 1/4"
 20,0 cm/8"

AA 301/16
 AA 301/20

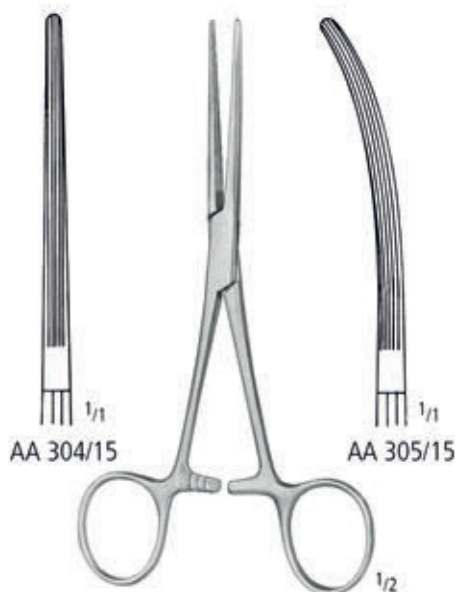

AA 304/15

AA 305/15

BAINBRIDGE

AA 304/15
 AA 304/18

15,0 cm/6"
 18,5 cm/7 1/3"

AA 305/15
 AA 305/18

Arterienklemmen
 Artery Forceps
 Pinzas hemostáticas
 Pincés hémostatiques
 Pinze emostatiche

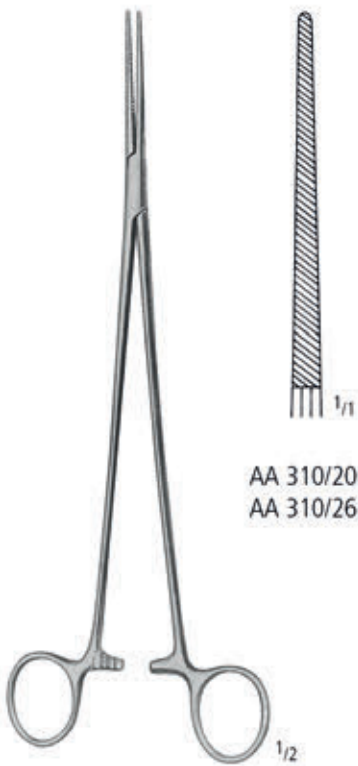

AA 310/20
 AA 310/26

20,0 cm/8"
 26,0 cm/10 1/2"



AA 311/20
 AA 311/26

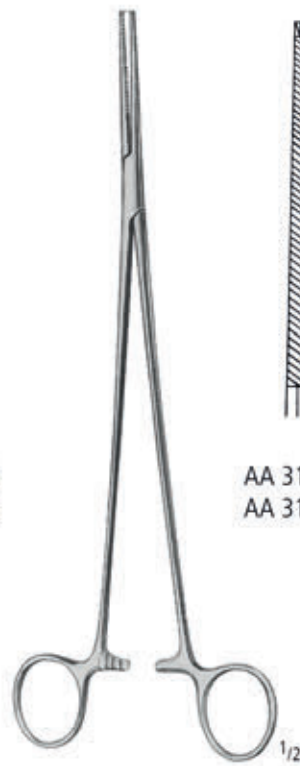

AA 312/20
 AA 312/26

20,0 cm/8"
 26,0 cm/10 1/2"



AA 313/20
 AA 313/26

BENGOLEA

BENGOLEA 1:2

Aurikelklemmen, Präparier- und Ligaturklemmen
 Auricle Forceps, Dissecting and Ligature Forceps
 Pinzas para aurícula, Pinzas para preparaciones y ligaduras
 Pincas auriculaires, Pincas à disséquer et à ligatures
 Pinze auricolari, Pinze per preparazioni e legature

AA
 AB
 AC
 AD
 AE
 AF
 AG
 AH
 AI
 AJ
 AK
 AL
 AM
 AN
 AO
 AP
 AQ
 AR
 AS
 AT
 AU
 AV
 AW
 AX
 AY
 AZ

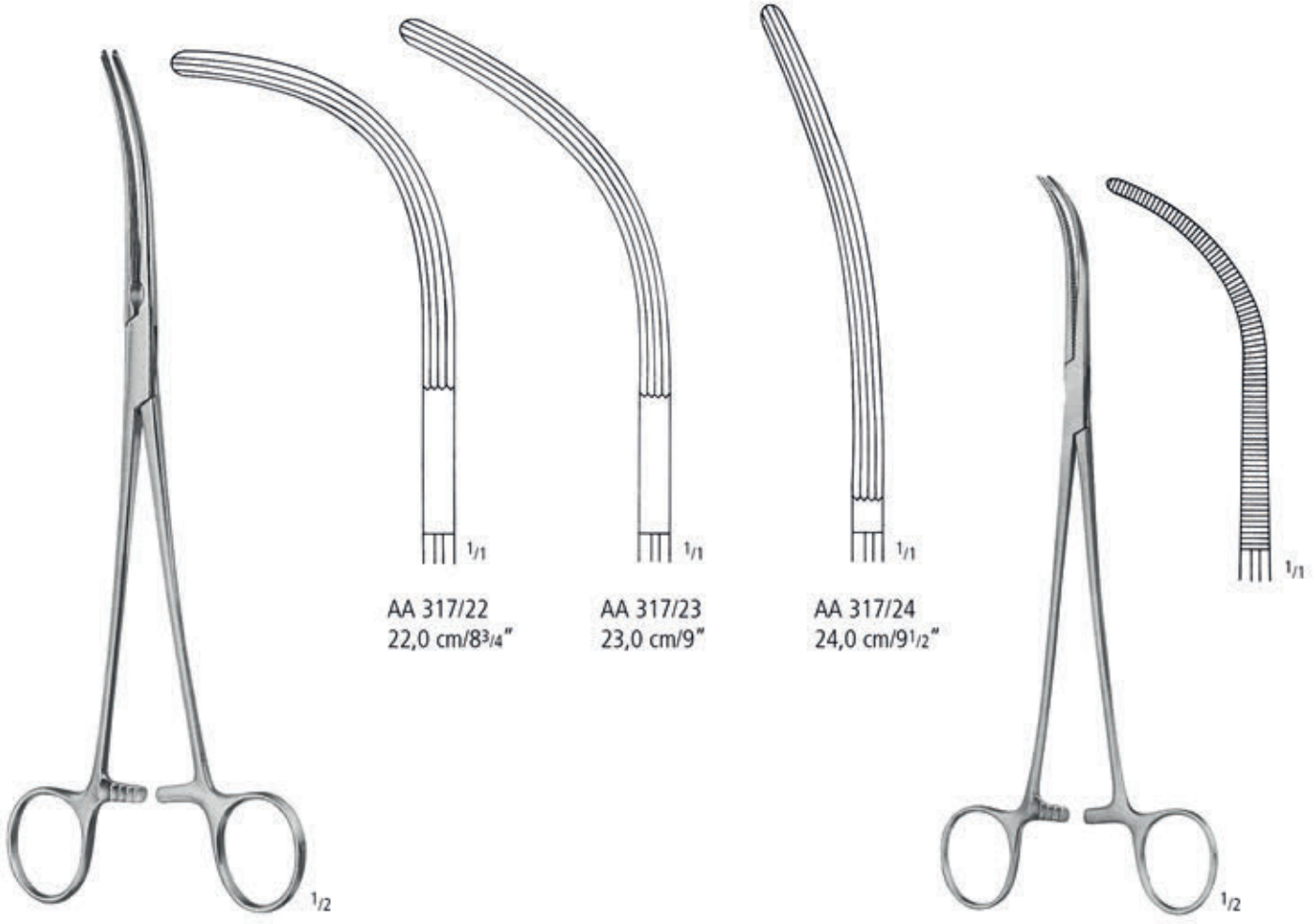

CRAFOORD-SELLORS

OVERHOLT-MIXTER

AA 319/21
 21,0 cm/8¹/₄"

Arterienklemmen, Bronchusklemmen
 Artery Forceps, Bronchus Forceps
 Pinzas hemostáticas, Pinzas-clamps bronquiales
 Pincés hémostatiques, Pincés-clamps à bronches
 Pinze emostatiche, Pinze per bronchi

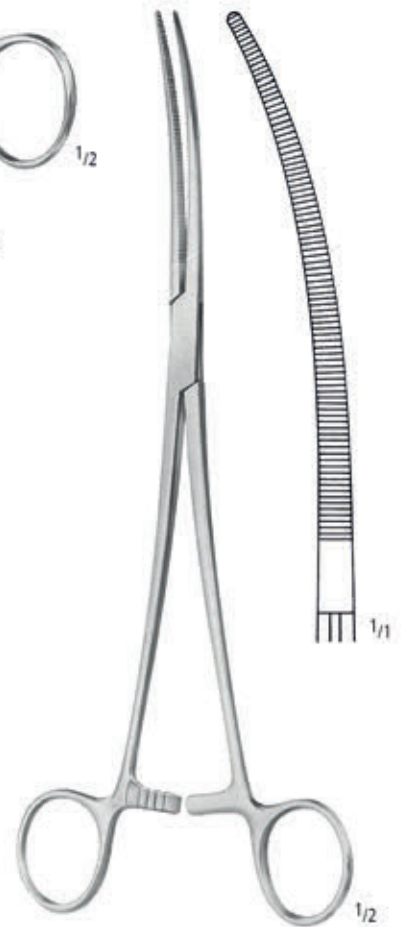
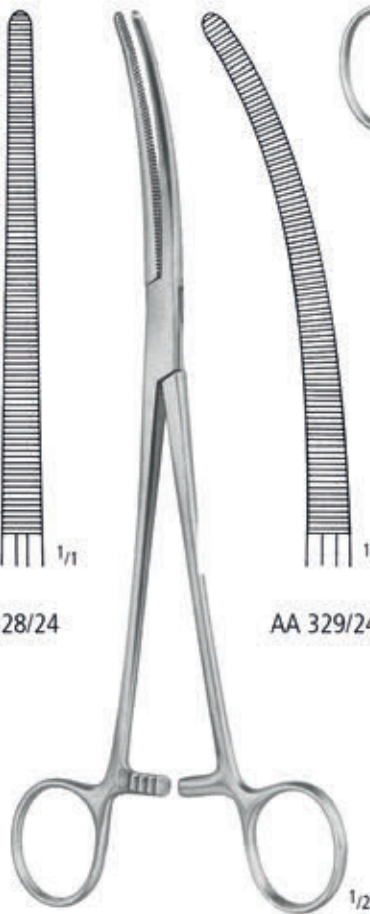
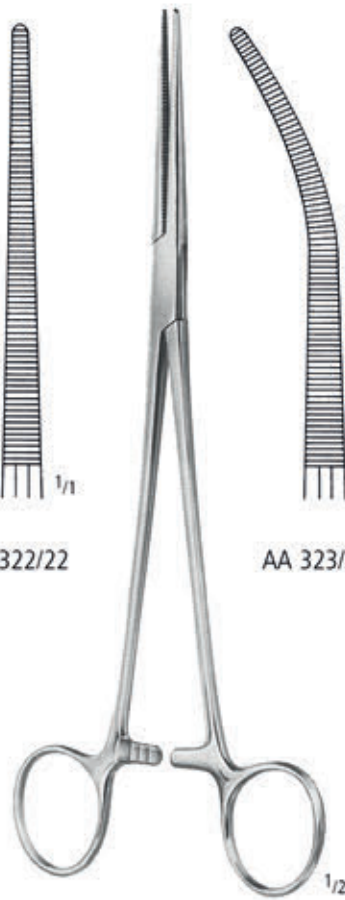
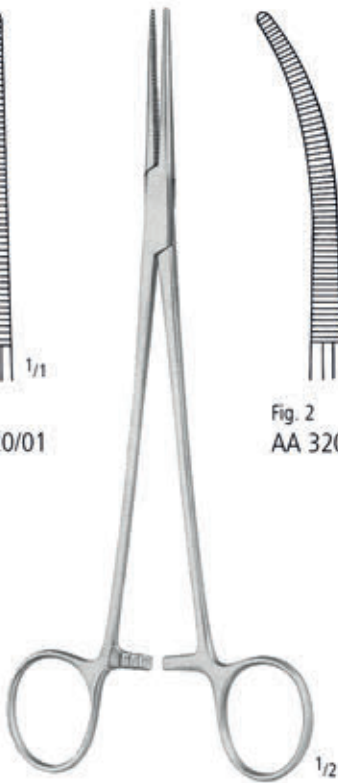

Präparier- und Ligaturklemmen
 Dissecting and Ligature Forceps
 Pinzas para preparaciones y ligaduras
 Pincas à disséquer et à ligatures
 Pinze per preparazioni e legature

AA

AB

AC

AD

AE

AF

AK

AL

AO

KA

KK

X



RUMEL
 23,0 cm/9"



AA 335/01



AA 335/02



AA 335/03



AA 335/04

Präparier- und Ligaturklemmen
 Dissecting and Ligature Forceps
 Pinzas para preparaciones y ligaduras
 Pincès à disséquer et à ligatures
 Pinze per preparazioni e legature

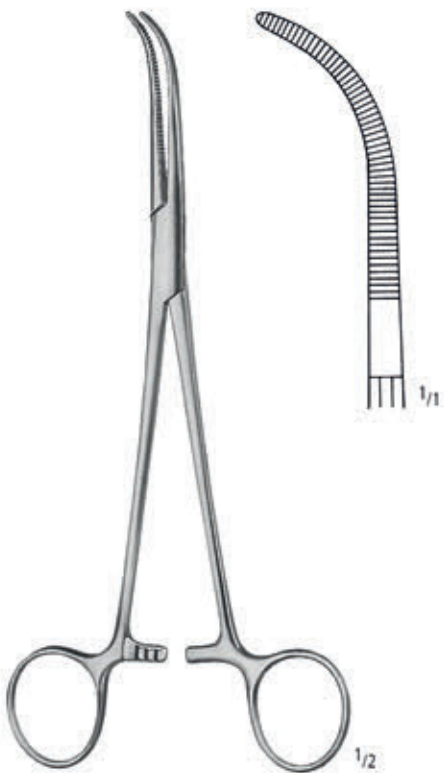

JOHNS HOPKINS
 AA 338/20
 20,0 cm/8"

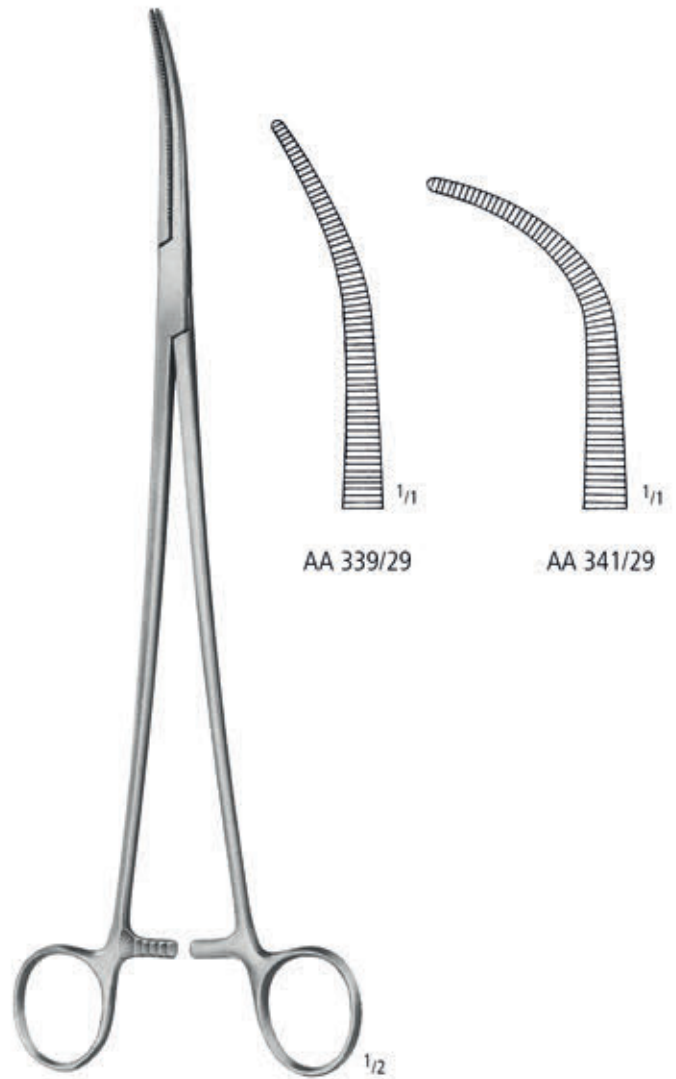

ZENKER
 29,5 cm/11½"

Präparier- und Ligaturklemmen
 Dissecting and Ligature Forceps
 Pinzas para preparaciones y ligaduras
 Pincès à disséquer et à ligatures
 Pinze per preparazioni e legature



MIXTER
 15,5 cm/6"
 19,0 cm/7½"

AA 345/15
 AA 345/19



MIXTER-O'SHAUGNESSY
 15,5 cm/6"
 19,0 cm/7½"

AA 347/15
 AA 347/19



BABY-MIXTER
 AA 348/18
 18,0 cm/7"

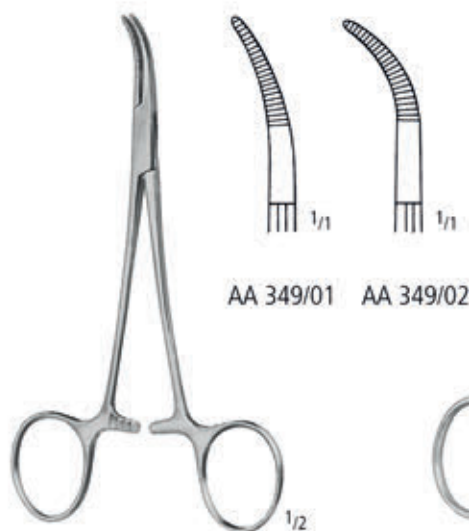

AA 349/01 AA 349/02

BABY-MIXTER
 14,0 cm/5½"



MIXTER

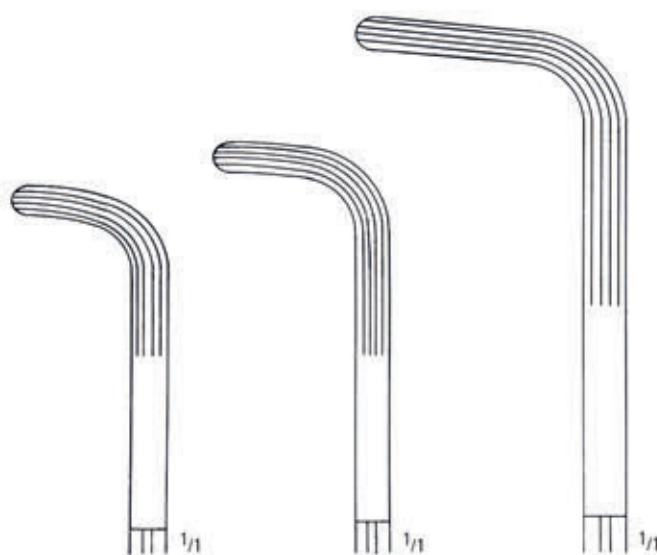

Fig. 1
 AA 353/22
 22,0 cm/8¾"

Fig. 2
 AA 353/25
 25,0 cm/10"

Fig. 3
 AA 353/28
 28,0 cm/11"

AA
 AB
 AC
 AD
 AE
 AF
 AK
 AL
 AO
 KA
 KK
 X

Präparier- und Ligaturklemmen
 Dissecting and Ligature Forceps
 Pinzas para preparaciones y ligaduras
 Pincès à disséquer et à ligatures
 Pinze per preparazioni e legature

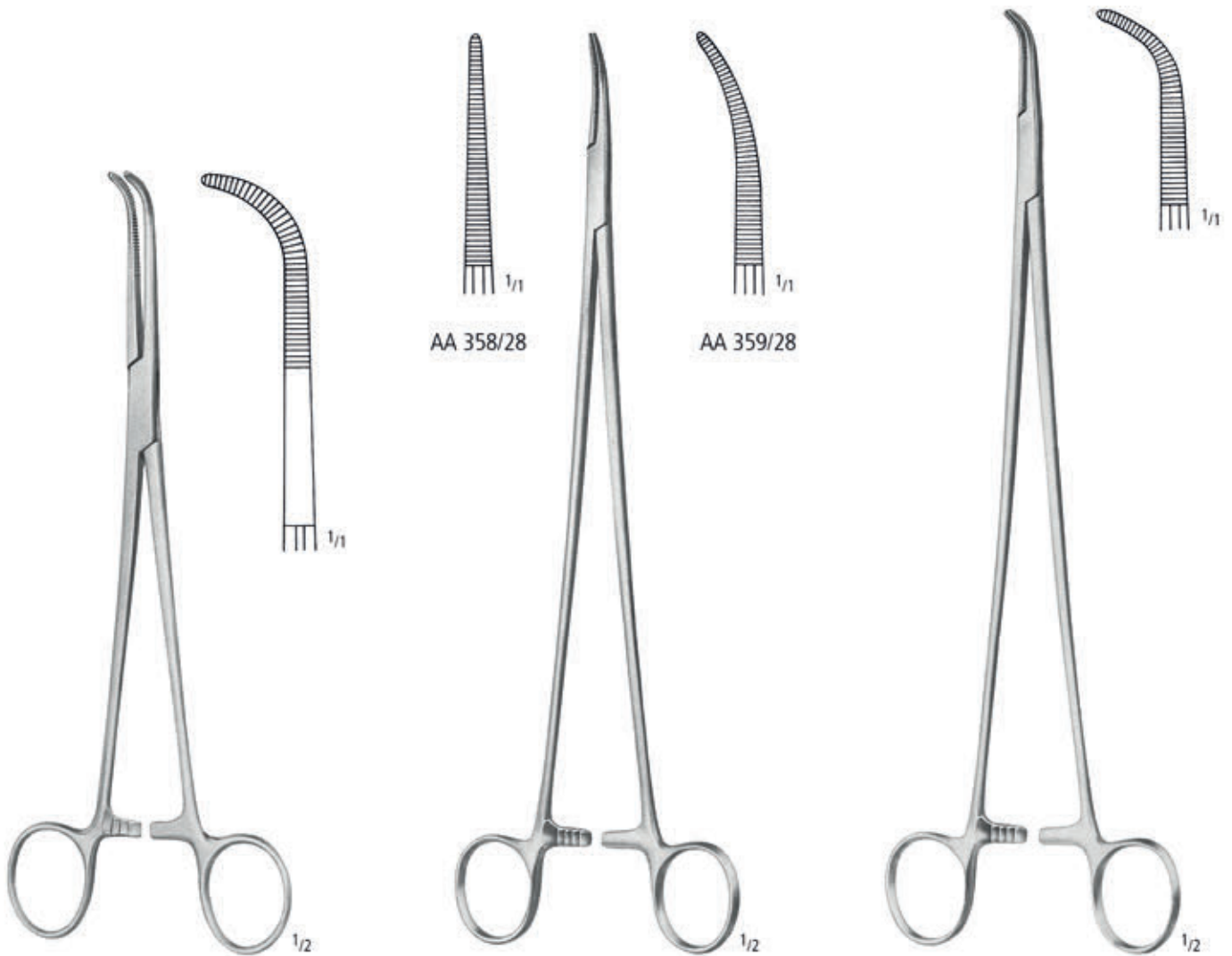

MIXTER
 AA 355/23
 23,0 cm/9"

BRIDGE
 28,0 cm/11"

LAWRENCE
 AA 361/28
 28,0 cm/11"

Präparier- und Ligaturklemmen
 Dissecting and Ligature Forceps
 Pinzas para preparaciones y ligaduras
 Pincès à disséquer et à ligatures
 Pinze per preparazioni e legature

AA
 AB
 AC
 AD
 AE
 AF
 AK
 AL
 AO
 KA
 KK
 X



KANTROWITZ

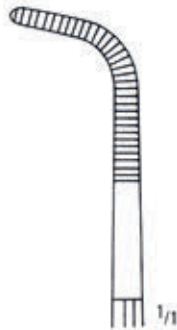

AA 363/20
 20,0 cm/8"



AA 363/24
 24,0 cm/9 1/2"

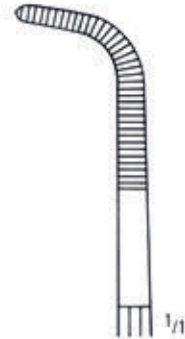

AA 363/28
 28,0 cm/11"



GEMINI



AA 365/14
 14,0 cm/5 1/2"



AA 365/18
 18,0 cm/7"



AA 365/22
 22,0 cm/8 3/4"



AA 365/25
 25,0 cm/10"



AA 365/28
 28,0 cm/11"

Präparier- und Ligaturklemmen
 Dissecting and Ligature Forceps
 Pinzas para preparaciones y ligaduras
 Pincès à disséquer et à ligatures
 Pinze per preparazioni e legature

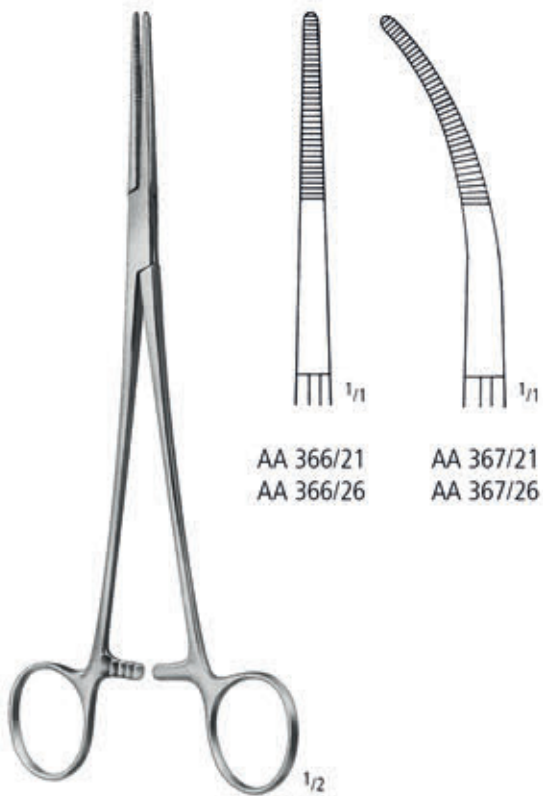

TOENNIS
 21,0 cm/8¹/₄"
 26,0 cm/10¹/₂"

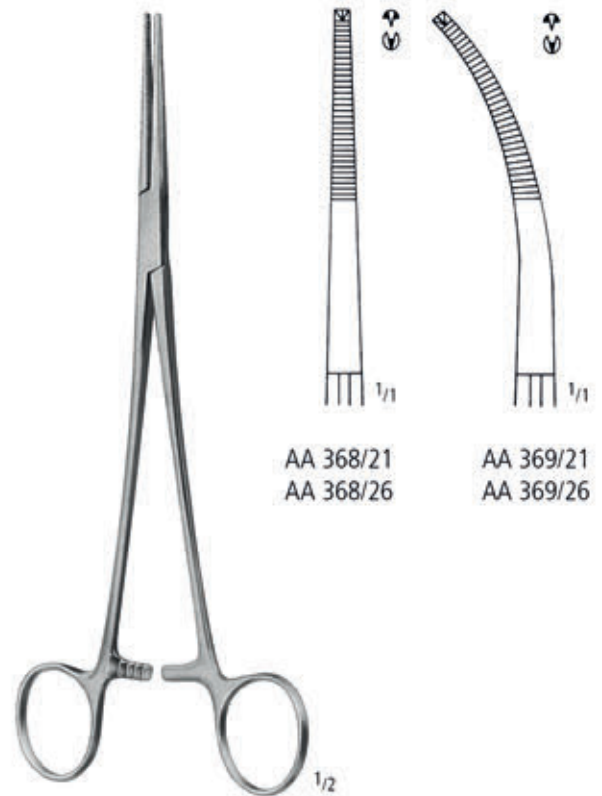

TOENNIS 1:2
 21,0 cm/8¹/₄"
 26,0 cm/10¹/₂"

Präparier- und Ligaturklemmen
 Dissecting and Ligature Forceps
 Pinzas para preparaciones y ligaduras
 Pincés à disséquer et à ligatures
 Pinze per preparazioni e legature

AA

AB

AC

AD

AE

AF

AK

AL

AO

KA

KK

X

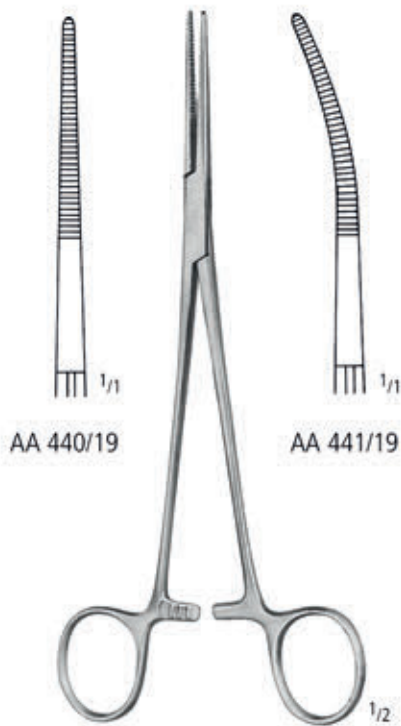

BIRKETT
 19,0 cm/7 1/2"

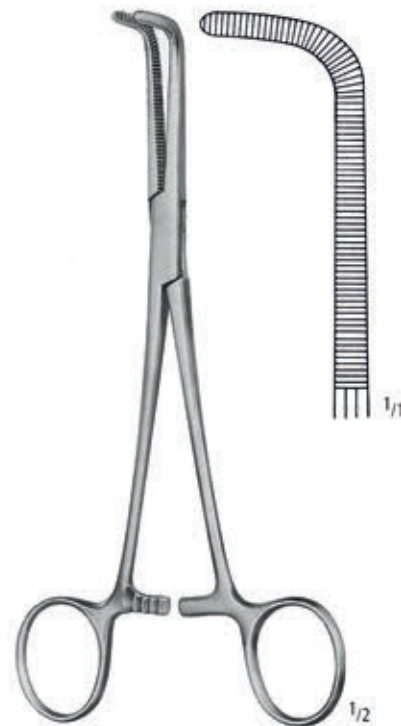

WIKSTROEM
 AA 443/19
 19,0 cm/7 1/2"

Tuchklemmen
Towel Forceps
Pinzas para compresas, Pinzas de campo
Pinces à champs, Pinces à compresses
Pinze per fissare le compresse (Fissatele)



SCHAEDEL
AA 710/09
9,0 cm/3 1/2"



JONES
AA 711/05
AA 711/09
5,0 cm/2"
9,0 cm/3 1/2"



ENGL. MODELL
AA 717/09
9,0 cm/3 1/2"



DOYEN
AA 721/18
18,0 cm/7"



BERNHARD
AA 726/16
16,5 cm/6 1/2"



LANE
AA 730/15
AA 730/18
AA 730/20
15,0 cm/6"
18,0 cm/7"
20,0 cm/8"

Tuchklemmen
Towel Forceps
Pinzas para compresas, Pinzas de campo
Pinces à champs, Pinces à compresses
Pinze per fissare le compresse (Fissatele)



AA 749/11
11,0 cm/4¹/₃"

- mit Schlauch- oder Kabelhalter
- with clip for tubing or cable
- con porta-tubo o porta-cable
- avec clamp porte-tube ou porte-corton d'alimentation
- con porta tubo o porta cavo



BACKHAUS

- | | |
|-----------------------------------------|-----------|
| 8,0 cm/3" | AA 751/08 |
| 11,0 cm/4 ¹ / ₃ " | AA 751/11 |
| 13,0 cm/5" | AA 751/13 |
| 15,0 cm/6" | AA 751/15 |



BALL & SOCKET

- | | |
|-----------------------------------------|-----------|
| 11,0 cm/4 ¹ / ₃ " | AA 753/11 |
| 13,0 cm/5" | AA 753/13 |

für Papiertücher
for paper tissues
para servilletas de papel
pour serviettes en papier
per tessuti di carta



ROEDER

- | | |
|------------|-----------|
| 13,0 cm/5" | AA 761/13 |
| 15,0 cm/6" | AA 761/15 |



LORNA

- | | |
|------------|-----------|
| 10,0 cm/4" | AA 763/10 |
| 13,0 cm/5" | AA 763/13 |

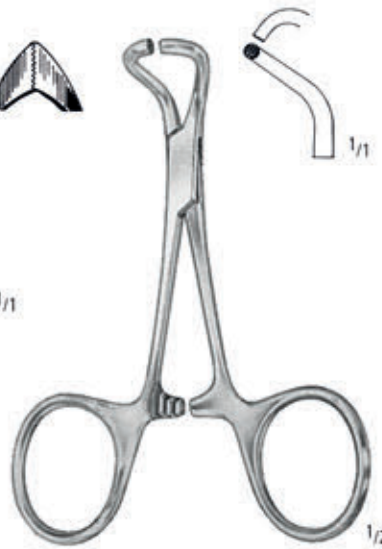

TOHOKU-JAPAN

- | | |
|------------|-----------|
| 10,0 cm/4" | AA 764/10 |
| 13,0 cm/5" | AA 764/13 |

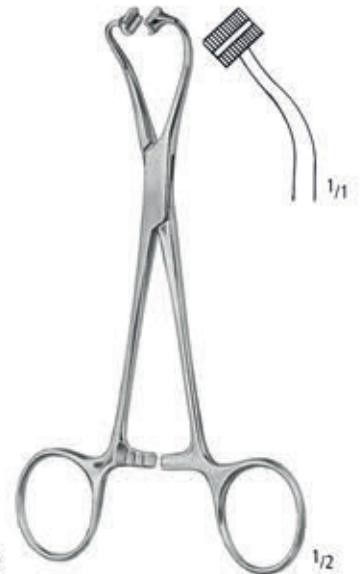

PEERS

- | |
|-----------------------------------------|
| AA 765/14 |
| 14,5 cm/5 ³ / ₄ " |

AA
AB
AC
AD
AE
AF
AK
AL
AO
KA
KK
X

Schlauchklemmen
Tubing Clamps
Pinzas para tubos
Presses-tube
Pinze serratubi

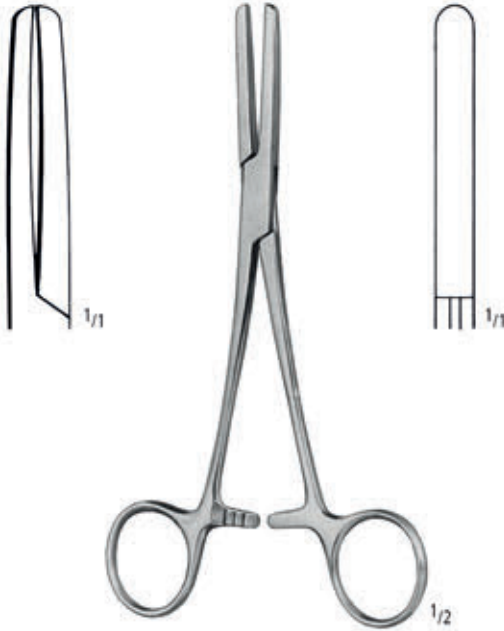

PRESBYTERIAN

16,5 cm/6¹/₂" AA 790/16
18,0 cm/7" AA 790/18



KLINIKUM BERLIN

AA 792/14
14,5 cm/5³/₄"
mit langer Sperre
with long ratchet
con cremallera larga
à crémaillère extra longue
con cremagliera extra lunga

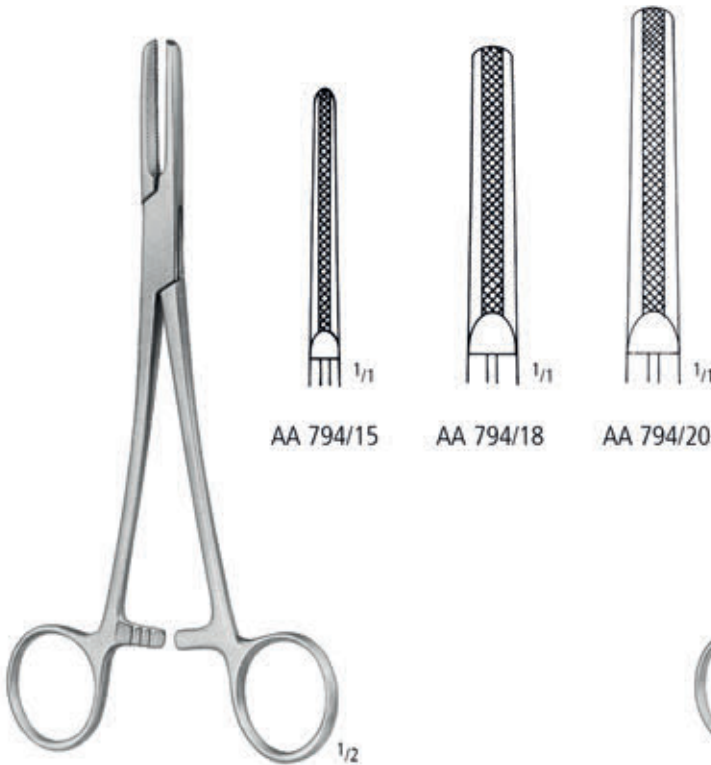

AA 794/15 AA 794/18 AA 794/20

AA 794/15 15,5 cm/6"
AA 794/18 18,0 cm/7"
AA 794/20 20,0 cm/8"

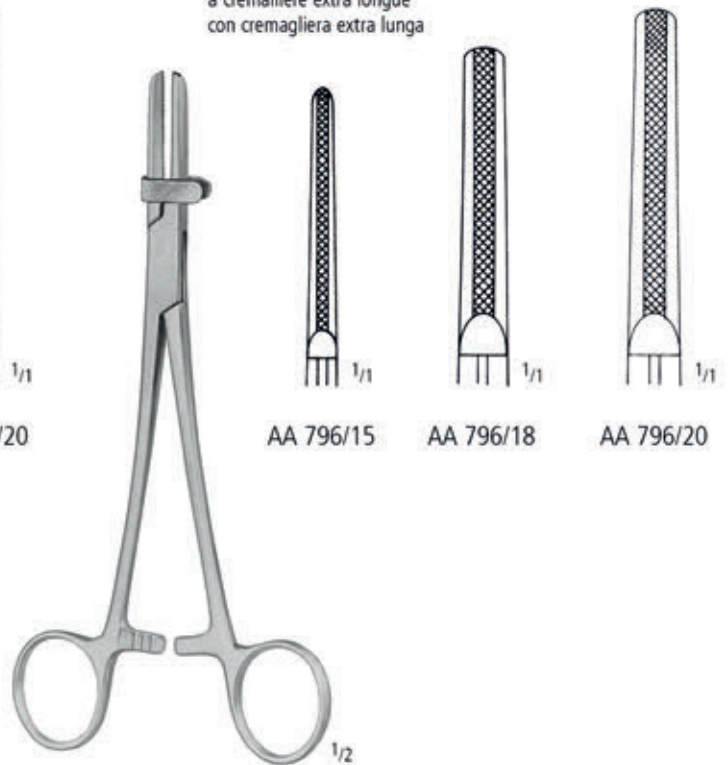

AA 796/15 AA 796/18 AA 796/20

AA 796/15
AA 796/18
AA 796/20

tini[®] instruments

nopa[®] instruments

titan-nitrid Beschichtung
titan-nitride surface coating



tini

AB

>> Pinzetten • Forceps • Pinzas • Pincers • Pinze



AC

>> Scheren • Scissors • Tijeras • Ciseaux • Forbici



AE

>> Naht • Suture • Sutura • Suture • Sutura



KA

>> Orthopädie • Orthopaedics • Ortopedia • Orthopédie • Ortopedia

KK

>> Herz/Thorax • Cardiovascular • Cardiovascular • Cardiovasculaire • Cardiovascolare

KS

>> Neurochirurgie • Neurosurgery • Neurocirugía • Neurochirurgie • Neurochirurgia

- >> extrem lange Lebensdauer und Einsatzfähigkeit
- >> enorm hohe Verschleißfestigkeit - nur selten Nachschleifen notwendig
- >> blendfreie Oberfläche - keine störenden Lichtreflexionen
- >> mikroglatte Oberfläche - deutlich verbesserte Korrosionsbeständigkeit
- >> titan-nitrid ist gewebeverträglich und biokompatibel
- >> anti-allergene Schutzfunktion

- >> longer durability and usability
- >> enormous high abrasion resistance - sharpening is hardly ever necessary
- >> reduction of reflective glare - no incommoding luminous reflectance
- >> micro-smooth surface - obviously improved corrosion resistance
- >> titan-nitride is tissuecompatible and biocompatible
- >> anallergenic protection



PINZETTEN
FORCEPS
PINZAS
PINCES
PINZE

AB

nopa[®] instruments

Weitere Pinzetten finden Sie in unserem Katalog „Allgemeine Chirurgie“ in Gruppe AB.

For further forceps kindly refer to our catalogue „General Surgery“, section AB.

Para pinzas adicionales, por favor consulte nuestro catálogo de „Cirugía general“, grupo AB.

Pour des pinces supplémentaires, consultez notre catalogue „Chirurgie Generale“, section AB.

Per gli altri pinze, consultare il nostro catalogo „Chirurgia Generale“, gruppo AB.







titan instruments

nopa[®] instruments

Besonderheit:

nopa Titan Instrumente bieten insbesondere in der Herz-Thorax-Chirurgie Vorteile gegenüber herkömmlichen Instrumenten. Titan ist ca. 45% leichter als rostfreier Edelstahl, weshalb Titan Instrumente weniger traumatisierend sind. Titan ist außerdem ein vollkommen korrosionsbeständiges und antimagnetisches Material. **nopa** Titan Instrumente bedeuten größtmöglichen Komfort für den Chirurgen.

Features:

nopa Titan Instruments provide especially in Cardiovascular surgery a significant advantage compared to other Instruments. Titan is approximately 45% lighter than stainless steel. For that reason, Titan Instruments are less traumatic. Besides that, Titan is a completely stainless and anti-magnetic material. **nopa** Titan Instruments are the most comfortable choice for the Cardiovascular surgeon.

AB 100/12 T	ADSON DRESSING FORCEPS 12.0 CM
AB 110/12 T	ADSON TISSUE FCPS. 1X2 TEETH 12.0 CM
AB 116/07 T	ADSON-BROWN TISS. FCPS. STR. 7X7 TEETH 12.0 CM
AB 120/15 T	SEMKEN DRESSING FCPS. STR. 15.5 CM
AB 160/18 T	GERALD DRESSING FCPS. STR. 18.0 CM
AB 170/18 T	GERALD TISSUE FCPS. STR. 1X2 TEETH 17.0 CM
AB 542/15 T	SUTURE TYING FCPS. 0.3 MM STR. 15.0 CM
AB 860/16 T	DE BAKEY ATR. FCPS. STR. 1.5 MM 16.0 CM
AB 860/20 T	DE BAKEY ATR. FCPS. STR. 1.5 MM 20.0 CM
AB 860/24 T	DE BAKEY ATR. FCPS. STR. 1.5 MM 24.0 CM
AB 862/16 T	DE BAKEY ATR. FCPS. STR. 2.0 MM 16.0 CM
AB 862/20 T	DE BAKEY ATR. FCPS. STR. 2.0 MM 20.0 CM
AB 862/24 T	DE BAKEY ATR. FCPS. STR. 2.0 MM 24.0 CM
AB 864/16 T	DE BAKEY ATR. FCPS. STR. 2.8 MM 16.0 CM
AB 864/20 T	DE BAKEY ATR. FCPS. STR. 2.8 MM 20.0 CM



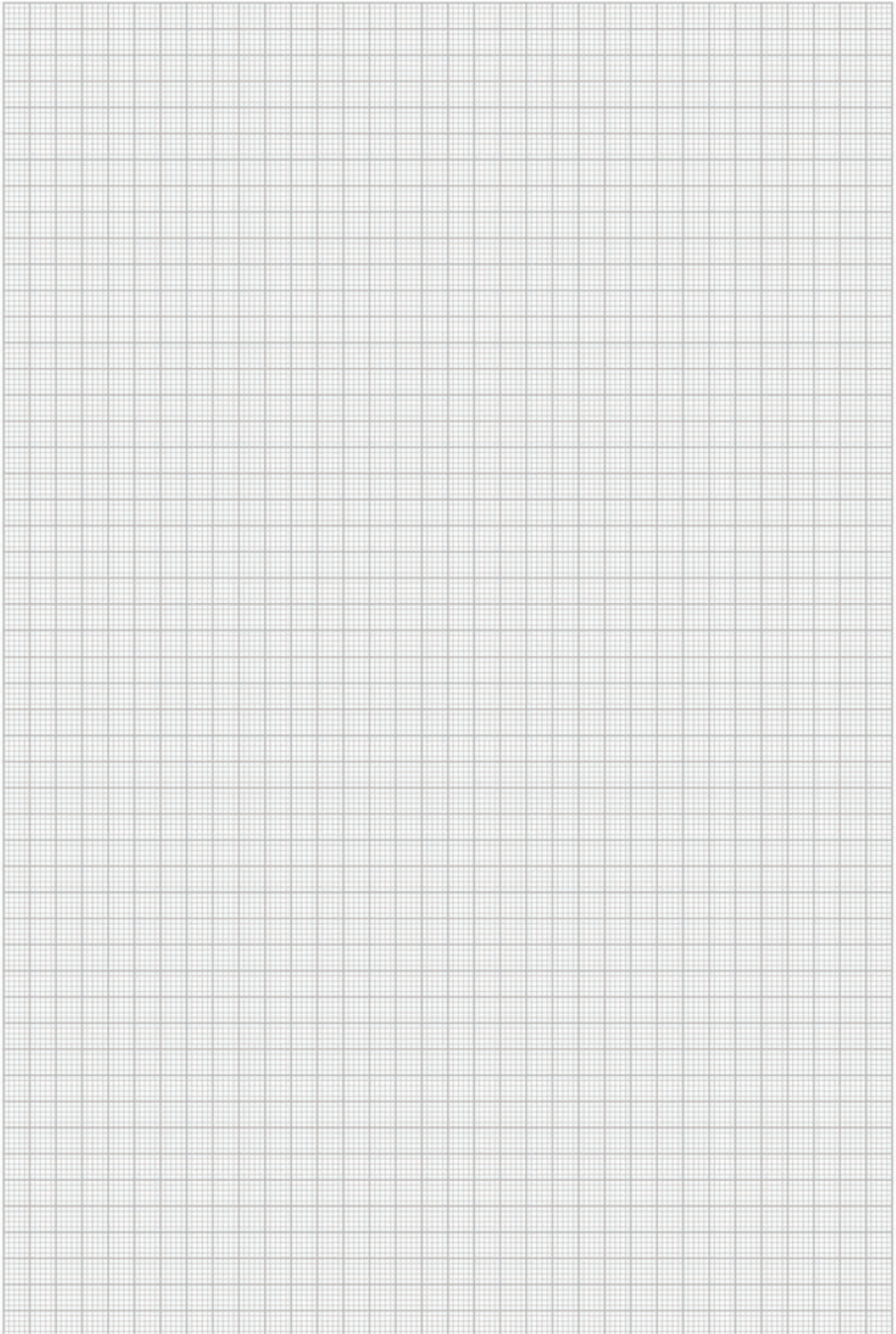

PINZETTEN FORCEPS PINZAS PINCES PINZE

Anatomische Pinzetten, Chirurgische Pinzetten
 Dressing Forceps, Tissue Forceps
 Pinzas de disección, Pinzas de disección con dientes
 Pincès à dissection, Pincès à griffes
 Pinze anatomiche per dissezione, Pinze chirurgiche a denti di topo



STANDARD

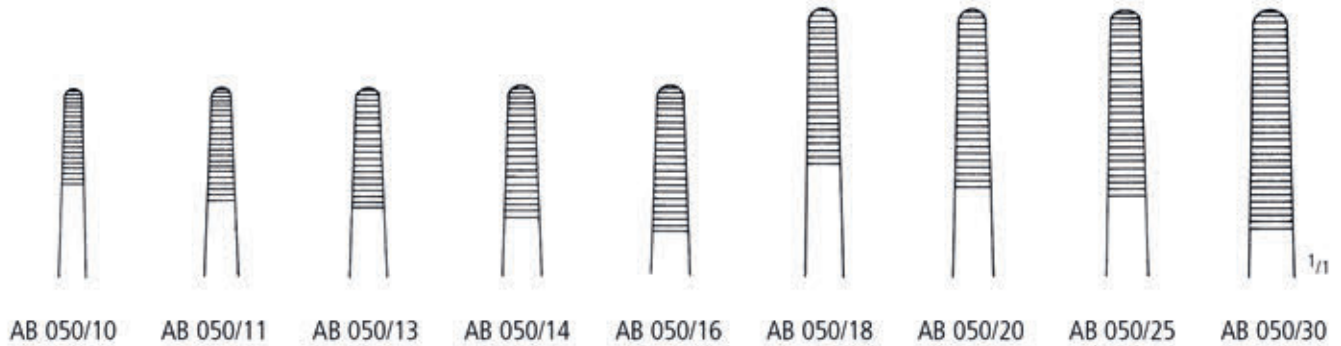

10,5 cm/4 1/4"	AB 050/10
11,5 cm/4 1/2"	AB 050/11
13,0 cm/5"	AB 050/13
14,5 cm/5 3/4"	AB 050/14
16,0 cm/6 1/4"	AB 050/16
18,0 cm/7"	AB 050/18
20,0 cm/8"	AB 050/20
25,0 cm/10"	AB 050/25
30,0 cm/12"	AB 050/30



1:2
STANDARD

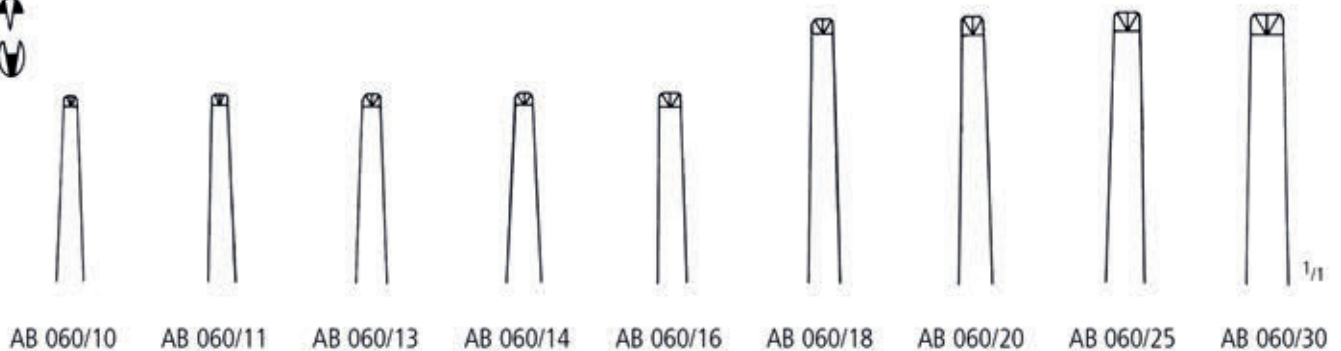

10,5 cm/4 1/4"	AB 060/10
11,5 cm/4 1/2"	AB 060/11
13,0 cm/5"	AB 060/13
14,5 cm/5 3/4"	AB 060/14
16,0 cm/6 1/4"	AB 060/16
18,0 cm/7"	AB 060/18
20,0 cm/8"	AB 060/20
25,0 cm/10"	AB 060/25
30,0 cm/12"	AB 060/30

AA
 AB
 AC
 AD
 AE
 AF
 AK
 AL
 AO
 KA
 KK
 X

AB PINZETTEN FORCEPS PINZAS PINCES PINZE

Anatomische Pinzetten, Chirurgische Pinzetten
 Dressing Forceps, Tissue Forceps
 Pinzas de disección, Pinzas de disección con dientes
 Pincers à dissection, Pincers à griffes
 Pinze anatomiche per dissezione, Pinze chirurgiche a denti di topo



AB 100/12



AB 102/12



AB 110/12



AB 112/12

12,0 cm/4³/₄"
 15,0 cm/6"

ADSON
 AB 100/12
 AB 100/15

MICRO-ADSON
 AB 102/12
 AB 102/15

ADSON 1:2
 AB 110/12
 AB 110/15

MICRO-ADSON 1:2
 AB 112/12
 AB 112/15

PINZETTEN FORCEPS PINZAS PINCES PINZE

Anatomische Pinzetten, Chirurgische Pinzetten
 Dressing Forceps, Tissue Forceps
 Pinzas de disección, Pinzas de disección con dientes
 Pincers à dissection, Pincers à griffes
 Pinze anatomiche per dissezione, Pinze chirurgiche a denti di topo

AA

AB

AC

AD

AE

AF

AK

AL

AO

KA

KK

X

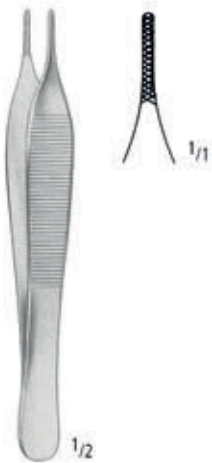

ADSON
 AB 114/12
 12,0 cm/4³/₄"

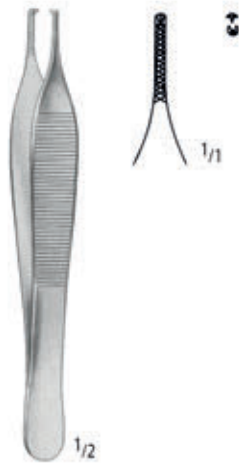

ADSON 1:2
 AB 115/12
 12,0 cm/4³/₄"



ADSON-BROWN
 12,0 cm/4³/₄"



ADSON-BROWN
 AB 117/09
 12,0 cm/4³/₄"



EWALD
 AB 118/01
 12,0 cm/4³/₄"



EWALD 1:2
 AB 118/02
 12,0 cm/4³/₄"



McINDOE
 AB 119/15
 15,0 cm/6"



SEMKEN
 AB 120/12
 AB 120/15



SEMKEN
 12,5 cm/5"
 15,5 cm/6"
 AB 121/12
 AB 121/15

AB PINZETTEN FORCEPS PINZAS PINCES PINZE

Anatomische Pinzetten, Chirurgische Pinzetten
 Dressing Forceps, Tissue Forceps
 Pinzas de disección, Pinzas de disección con dientes
 Pincés à dissection, Pincés à griffes
 Pinze anatomiche per dissezione, Pinze chirurgiche a denti di topo



AB 130/12



AB 131/12

SEMKEN 1:2
 AB 130/12 12,5 cm/5"
 AB 130/15 15,5 cm/6"
 AB 131/12
 AB 131/15



TAYLOR
 AB 140/17
 17,5 cm/7"



TAYLOR
 AB 141/17
 17,5 cm/7"



TAYLOR
 AB 142/17
 17,5 cm/7"



TAYLOR
 AB 143/17
 17,5 cm/7"

PINZETTEN FORCEPS PINZAS PINCES PINZE

Anatomische Pinzetten, Chirurgische Pinzetten
 Dressing Forceps, Tissue Forceps
 Pinzas de disección, Pinzas de disección con dientes
 Pincers à dissection, Pincers à griffes
 Pinze anatomiche per dissezione, Pinze chirurgiche a denti di topo

AA

AB

AC

AD

AE

AF

AK

AL

AO

KA

KK

X

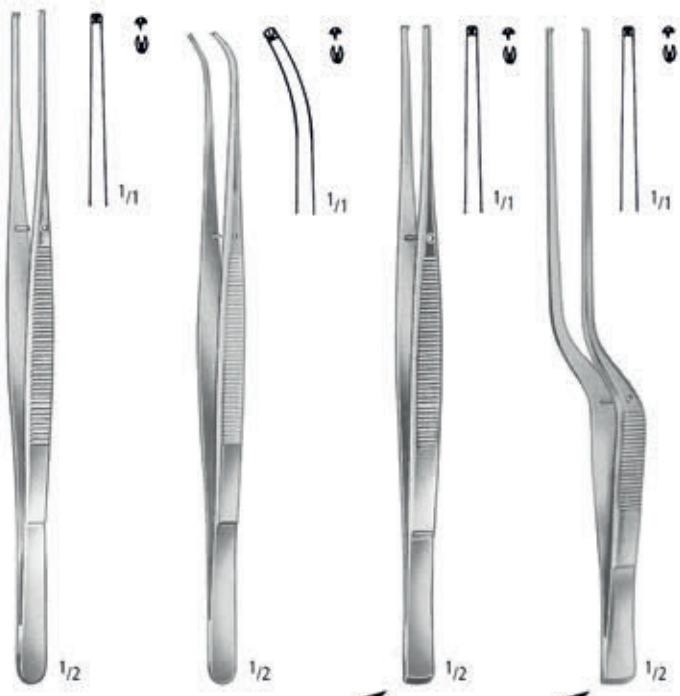

TAYLOR
1:2
 AB 150/17
 17,5 cm/7"

TAYLOR
1:2
 AB 151/17
 17,5 cm/7"

↗
TAYLOR
1:2
 AB 152/17
 17,5 cm/7"

↘
TAYLOR
1:2
 AB 153/17
 17,5 cm/7"

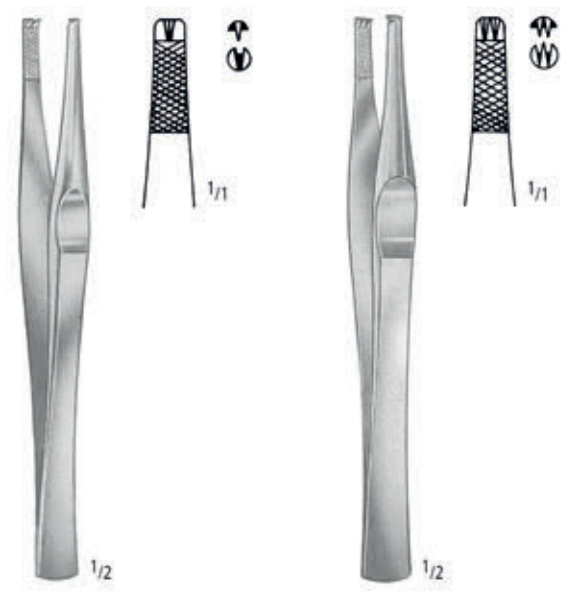

LANE
1:2
 AB 156/14
 AB 156/20
 14,5 cm/5³/₄"
 20,0 cm/8"

LANE
2:3
 AB 158/14
 AB 158/20

AB PINZETTEN FORCEPS PINZAS PINCES PINZE

Anatomische Pinzetten, Chirurgische Pinzetten
 Dressing Forceps, Tissue Forceps
 Pinzas de disección, Pinzas de disección con dientes
 Pincers à dissection, Pincers à griffes
 Pinze anatomiche per dissezione, Pinze chirurgiche a denti di topo



GERALD
 AB 160/18 18,0 cm/7"



GERALD
 AB 161/18



GERALD 1:2
 AB 170/18 18,0 cm/7"



GERALD 1:2
 AB 171/18



CUSHING
 AB 180/17 17,5 cm/7"



CUSHING
 AB 181/17



CUSHING 1:2
 AB 190/17 17,5 cm/7"



CUSHING 1:2
 AB 191/17

PINZETTEN FORCEPS PINZAS PINCES PINZE

Anatomische Pinzetten, Chirurgische Pinzetten
 Dressing Forceps, Tissue Forceps
 Pinzas de disección, Pinzas de disección con dientes
 Pincers à dissection, Pincers à griffes
 Pinze anatomiche per dissezione, Pinze chirurgiche a denti di topo



AB 200/18

POTTS-SMITH



AB 201/18



AB 210/18

**POTTS-SMITH
1:2**



AB 211/18

18,0 cm/7"
 21,0 cm/8 1/4"
 25,0 cm/10"

AB 200/18
 AB 200/21
 AB 200/25

AB 201/18
 AB 201/21
 AB 201/25

AB 210/18
 AB 210/21
 AB 210/25

AB 211/18
 AB 211/21
 AB 211/25



BROPHY



AB 251/20



**BROPHY
1:2**

AB 260/20



AB 261/20

20,0 cm/8"

AB 250/20

AA
 AB
 AC
 AD
 AE
 AF
 AK
 AL
 AO
 KA
 KK
 X

AB PINZETTEN FORCEPS PINZAS PINCES PINZE

Mikro-Pinzetten, Knüpfpinzetten mit Plateau
 Micro Forceps, Suture Tying Forceps with platform
 Micro-Pinzas, Pinzas de ligadura con plataforma
 Micro-Pinces, Pinces à ligature avec plate-forme
 Micro-Pinze, Pinze per legature con piattaforma

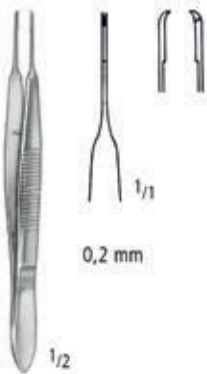

1:2
 AB 530/09
 9,5 cm/3³/₄"



AUSTIN
 AB 532/14
 14,0 cm/5¹/₂"



AUSTIN
 AB 532/18
 18,0 cm/7"

PINZETTEN FORCEPS PINZAS PINCES PINZE

Mikro-Pinzetten, Knüpfpinzetten mit Plateau, Gefäßdilator
 Micro Forceps, Suture Tying Forceps with platform, Vessel Dilator
 Micro-Pinzas, Pinzas de ligadura con plataforma, Dilatador para vasos
 Micro-Pinces, Pinces à ligature avec plate-forme, Dilatateur pour vaisseaux
 Micro-Pinze, Pinze per legature con piattaforma, Dilatatore per vasi



AB 536/14
 14,0 cm/5 1/2"



AB 538/14 1:2
 14,0 cm/5 1/2"



AB 540/14 1:2
 14,0 cm/5 1/2"

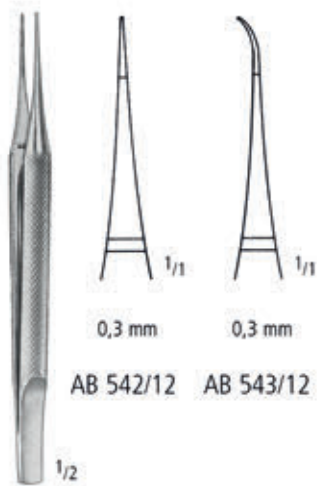

12,0 cm/4 3/4" AB 542/12 AB 543/12
 15,0 cm/6" AB 542/15 AB 543/15



18,0 cm/7"



AB 546/11
 11,0 cm/4 1/3"

AA
 AB
 AC
 AD
 AE
 AF
 AK
 AL
 AO
 KA
 KK
 X

AB PINZETTEN FORCEPS PINZAS PINCES PINZE

Atraumatische Pinzetten
 Non-traumatic Vascular Tissue Forceps
 Pinzas Atrauma
 Pincas Atrauma
 Pinze Atrauma

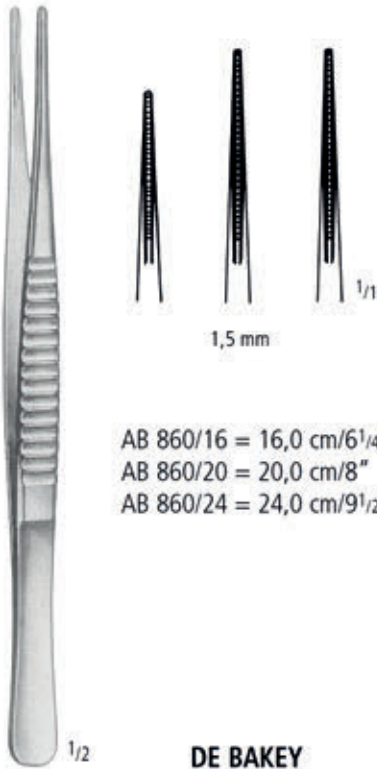

AB 860/16 = 16,0 cm/6¹/₄"
 AB 860/20 = 20,0 cm/8"
 AB 860/24 = 24,0 cm/9¹/₂"

DE BAKAY

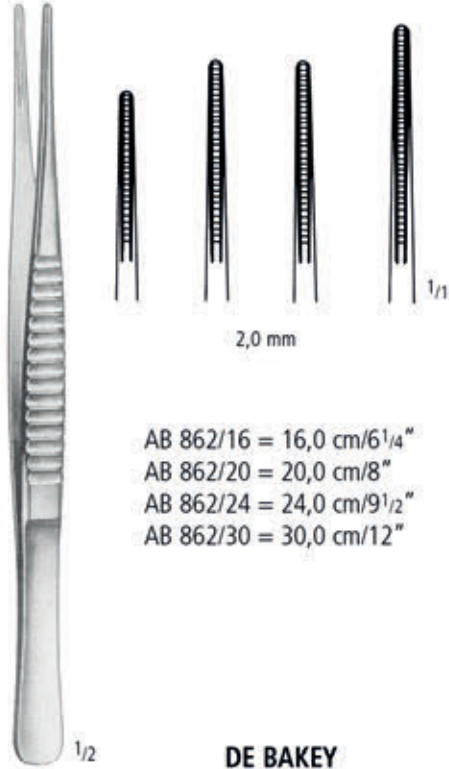

AB 862/16 = 16,0 cm/6¹/₄"
 AB 862/20 = 20,0 cm/8"
 AB 862/24 = 24,0 cm/9¹/₂"
 AB 862/30 = 30,0 cm/12"

DE BAKAY

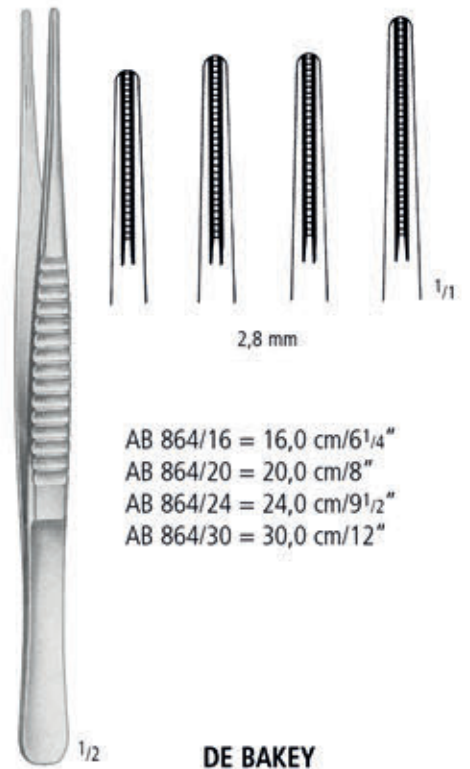

AB 864/16 = 16,0 cm/6¹/₄"
 AB 864/20 = 20,0 cm/8"
 AB 864/24 = 24,0 cm/9¹/₂"
 AB 864/30 = 30,0 cm/12"

DE BAKAY

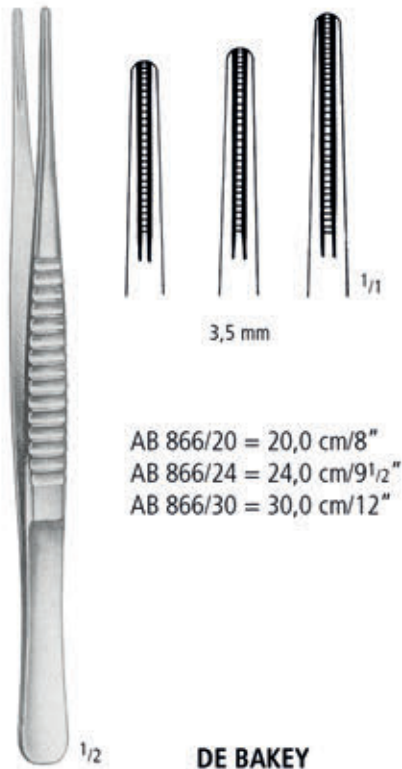

AB 866/20 = 20,0 cm/8"
 AB 866/24 = 24,0 cm/9¹/₂"
 AB 866/30 = 30,0 cm/12"

DE BAKAY

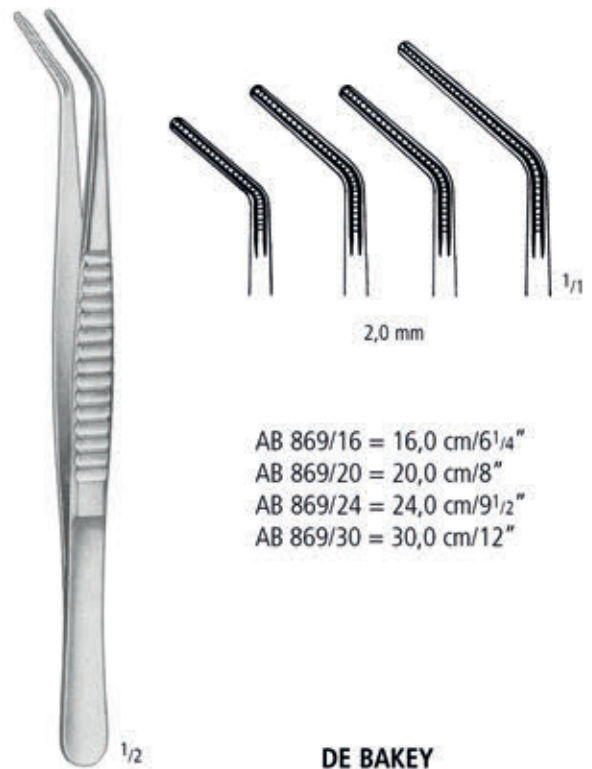

AB 869/16 = 16,0 cm/6¹/₄"
 AB 869/20 = 20,0 cm/8"
 AB 869/24 = 24,0 cm/9¹/₂"
 AB 869/30 = 30,0 cm/12"

DE BAKAY

PINZETTEN FORCEPS PINZAS PINCES PINZE

Pinzetten mit Hartmetalleinsätzen
 Dissecting Forceps with Tungsten Carbide Inserts
 Pinzas de disección con bocas de carburo de tungsteno
 Pincès à dissection avec mors en carbure de tungstène
 Pinze per dissezione con punte di carburo di tungsteno

AA
 AB
 AC
 AD
 AE
 AF
 AK
 AL
 AO
 KA
 KK
 X

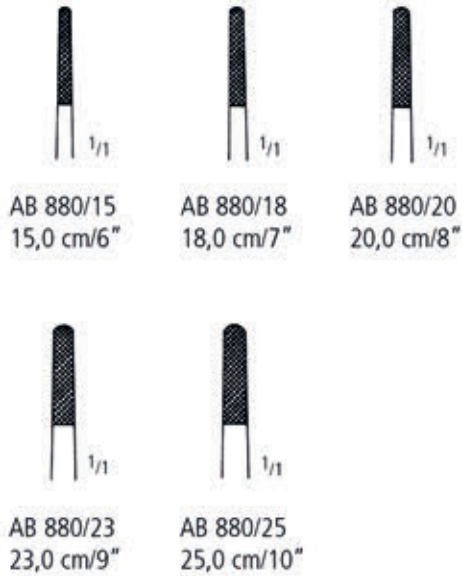

AB 880/15 15,0 cm/6"
 AB 880/18 18,0 cm/7"
 AB 880/20 20,0 cm/8"
 AB 880/23 23,0 cm/9"
 AB 880/25 25,0 cm/10"

POTTS-SMITH

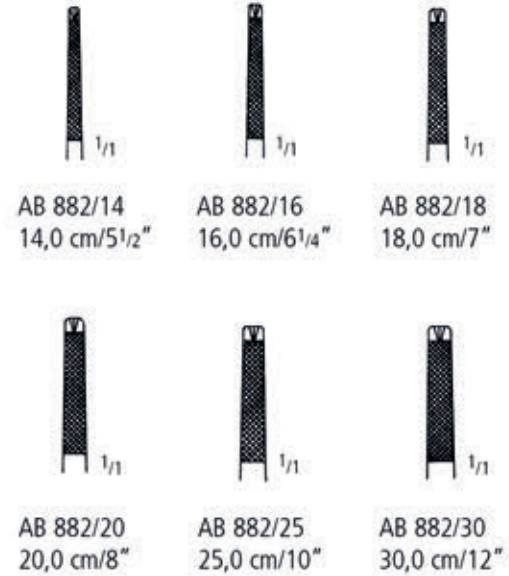

AB 882/14 14,0 cm/5 1/2"
 AB 882/16 16,0 cm/6 1/4"
 AB 882/18 18,0 cm/7"
 AB 882/20 20,0 cm/8"
 AB 882/25 25,0 cm/10"
 AB 882/30 30,0 cm/12"

OEHLER 1:2

nopa®
TUC



SEMKEN
 AB 890/12 12,5 cm/5"
 AB 890/15 15,5 cm/6"



GILLIES 1:2
 AB 900/15 15,0 cm/6"



JEWELER
 AB 902/15 15,0 cm/6"

AB PINZETTEN FORCEPS PINZAS PINCES PINZE

Pinzetten mit Hartmetalleinsätzen
 Dissecting Forceps with Tungsten Carbide Inserts
 Pinzas de disección con bocas de carburo de tungsteno
 Pincés à dissection avec mors en carbure de tungstène
 Pinze per dissezione con punte di carburo di tungsteno

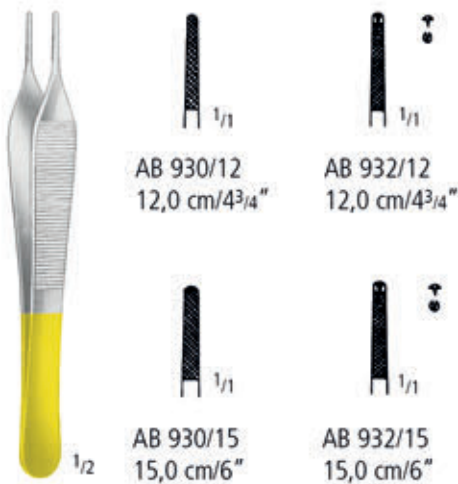

ADSON

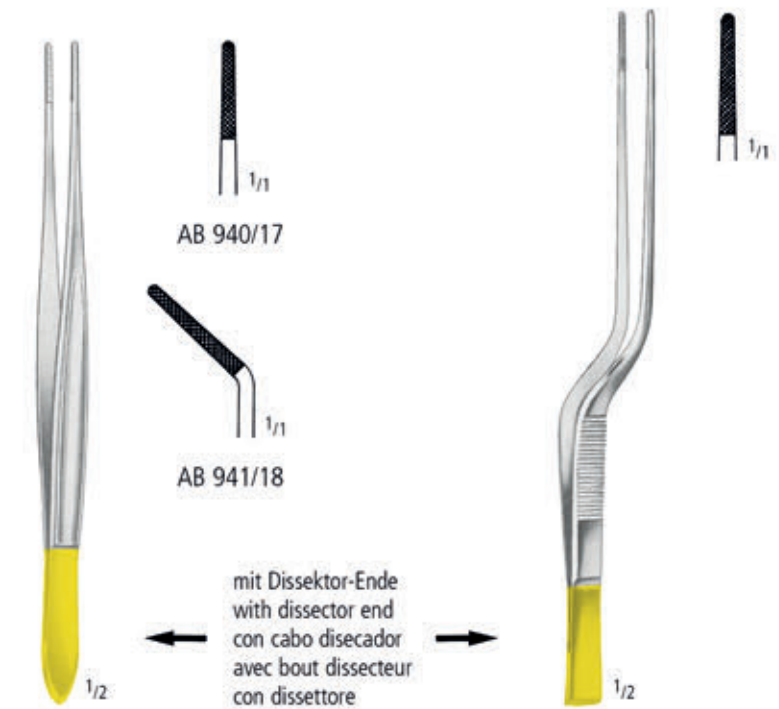

CUSHING
17,5 cm/7"

CUSHING-TAYLOR
AB 943/18
18,0 cm/7"

PINZETTEN FORCEPS PINZAS PINCES PINZE

Pinzetten mit Hartmetalleinsätzen
 Dissecting Forceps with Tungsten Carbide Inserts
 Pinzas de disección con bocas de carburo de tungsteno
 Pincès à dissection avec mors en carbure de tungstène
 Pinze per dissezione con punte di carburo di tungsteno



DE BAKEY
 16,0 cm/6¹/₄"
 20,0 cm/8"
 24,0 cm/9¹/₂"

1,5 mm	2,0 mm
AB 944/16	AB 946/16
AB 944/20	AB 946/20
AB 944/24	AB 946/24



BONNEY 1:2
 AB 948/18
 18,0 cm/7"



WANGENSTEEN

AB 950/15
 15,0 cm/6"

AB 950/23
 23,0 cm/9"

AA
 AB
 AC
 AD
 AE
 AF
 AK
 AL
 AO
 KA
 KK
 X



SCHEREN
SCISSORS
TIJERAS
CISEAUX
FORBICI

AC

nopa[®] instruments

Weitere Scheren finden Sie in unserem Katalog „Allgemeine Chirurgie“ in Gruppe AC.

For further scissors kindly refer to our catalogue „General Surgery“, section AC.

Para tijeras adicionales, por favor consulte nuestro catálogo de „Cirugía general“, grupo AC.

Pour des ciseaux supplémentaires, consultez notre catalogue „Chirurgie Generale“, section AC.

Per gli altri forbici, consultare il nostro catalogo „Chirurgia Generale“, gruppo AC.



nopa® SC
SUPER CUT



SUPER CUT

Besonderheit:

nopa Super Cut Scheren haben eine rasierklingenscharfe Schneide, kombiniert mit einer mikrogezahnten Schneide.

>> Diese Scheren sind durch schwarze Ringe gekennzeichnet.

Features:

nopa Super Cut scissors have a razor-like edge combined with one micro serrated blade.

>> Black rings for easy identification.

Verfügbare Modelle / Available Patterns

Im Katalog durch * markiert. / Marked in catalog with *.

AC	110/18	SC	METZENBAUM-NELSON SCS. STR.	BL/BL	18.0	CM	SC
AC	110/20	SC	METZENBAUM-NELSON SCS. STR.	BL/BL	20.0	CM	SC
AC	110/23	SC	METZENBAUM-NELSON SCS. STR.	BL/BL	23.0	CM	SC
AC	111/18	SC	METZENBAUM-NELSON SCS. CVD.	BL/BL	18.0	CM	SC
AC	111/20	SC	METZENBAUM-NELSON SCS. CVD.	BL/BL	20.0	CM	SC
AC	111/23	SC	METZENBAUM-NELSON SCS. CVD.	BL/BL	23.0	CM	SC
AC	141/14	SC	METZENBAUM-DELICATE SCS. BL/BL	CVD.	14.5	CM	SC
AC	151/18	SC	METZENBAUM-DELICATE SCS. BL/BL	CVD.	18.0	CM	SC
AC	214/15	SC	REYNOLDS DISS. SCS. STR.	SH/SH	15.0	CM	SC
AC	214/18	SC	REYNOLDS DISS. SCS. CVD.	SH/SH	18.0	CM	SC
AC	450/11	SC	IRIS SCS. STR.	SH/SH	11.5	CM	SC
AC	451/11	SC	IRIS SCS. CVD.	SH/SH	11.5	CM	SC
AC	476/11	SC	STEVENS TENOTOMY SCS. STR.	BL/BL	11.5	CM	SC
AC	477/11	SC	STEVENS TENOTOMY SCS. CVD.	BL/BL	11.5	CM	SC



titan instruments

nopa[®] instruments

Besonderheit:

nopa Titan Instrumente bieten insbesondere in der Herz-Thorax-Chirurgie Vorteile gegenüber herkömmlichen Instrumenten. Titan ist ca. 45% leichter als rostfreier Edelstahl, weshalb Titan Instrumente weniger traumatisierend sind. Titan ist außerdem ein vollkommen korrosionsbeständiges und antimagnetisches Material. **nopa** Titan Instrumente bedeuten größtmöglichen Komfort für den Chirurgen.

AC 870/11 T	MICRO SCISSORS 18.0 CM, 25°
AC 870/12 T	MICRO SCISSORS 18.0 CM, 45°
AC 870/13 T	MICRO SCISSORS 18.0 CM, 60°
AC 870/14 T	MICRO SCISSORS 18.0 CM, 90°
AC 870/15 T	MICRO SCISSORS 18.0 CM, 125°
AC 871/11 T	MICRO SCISSORS 18.0 CM, 25°
AC 871/12 T	MICRO SCISSORS 18.0 CM, 45°
AC 871/13 T	MICRO SCISSORS 18.0 CM, 60°
AC 871/14 T	MICRO SCISSORS 18.0 CM, 90°
AC 871/15 T	MICRO SCISSORS 18.0 CM, 125°

Features:

nopa Titan Instruments provide especially in Cardiovascular surgery a significant advantage compared to other Instruments. Titan is approximately 45% lighter than stainless steel. For that reason, Titan Instruments are less traumatic. Besides that, Titan is a completely stainless and anti-magnetic material. **nopa** Titan Instruments are the most comfortable choice for the Cardiovascular surgeon.





SCHEREN SCISSORS TIJERAS CISEAUX FORBICI

Präparierscheren
Dissecting Scissors
Tijeras para preparaciones
Ciseaux à dissection
Forbici per preparazioni

AA
AB
AC
AD
AE
AF
AK
AL
AO
KA
KK
X



METZENBAUM-NELSON



METZENBAUM-NELSON



Fig. 1



Fig. 2



Fig. 3



18,0 cm/7"	AC 110/18*	AC 111/18*	AC 120/18	AC 121/18	AC 130/18	AC 131/18
20,0 cm/8"	AC 110/20*	AC 111/20*	AC 120/20	AC 121/20	AC 130/20	AC 131/20
23,0 cm/9"	AC 110/23*	AC 111/23*	AC 120/23	AC 121/23	AC 130/23	AC 131/23
25,0 cm/10"	AC 110/25	AC 111/25	AC 120/25	AC 121/25	AC 130/25	AC 131/25
28,0 cm/11"	AC 110/28	AC 111/28	AC 120/28	AC 121/28	AC 130/28	AC 131/28
30,0 cm/12"	AC 110/30	AC 111/30	AC 120/30	AC 121/30	AC 130/30	AC 131/30

Präparierscheren, DELICATE
 Dissecting Scissors, DELICATE
 Tijeras para preparaciones, DELICATE
 Ciseaux à dissection, DELICATE
 Forbici per preparazioni, DELICATE

METZENBAUM-DELICATE



Fig. 1
 AC 140/14
 14,5 cm/5³/₄"



Fig. 1
 AC 141/14*
 14,5 cm/5³/₄"



Fig. 3
 AC 142/14
 14,5 cm/5³/₄"

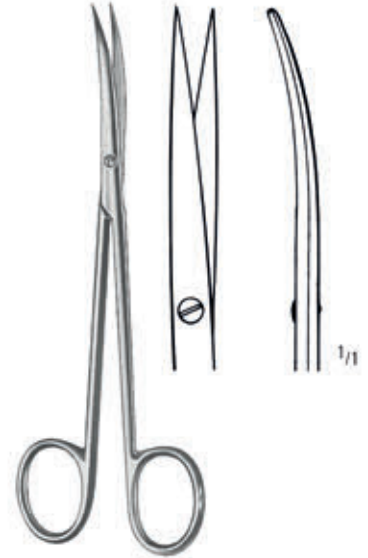

Fig. 3
 AC 143/14
 14,5 cm/5³/₄"

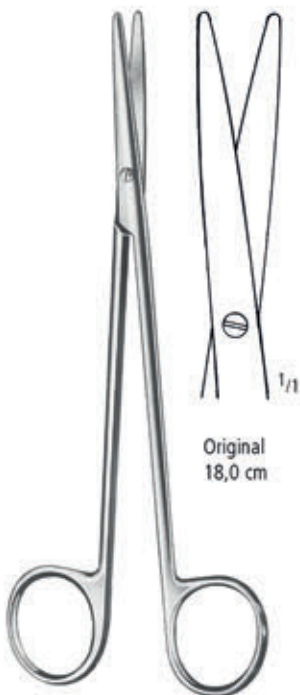

Fig. 1

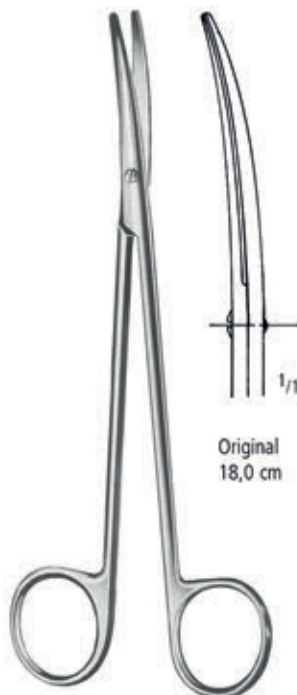

Fig. 1

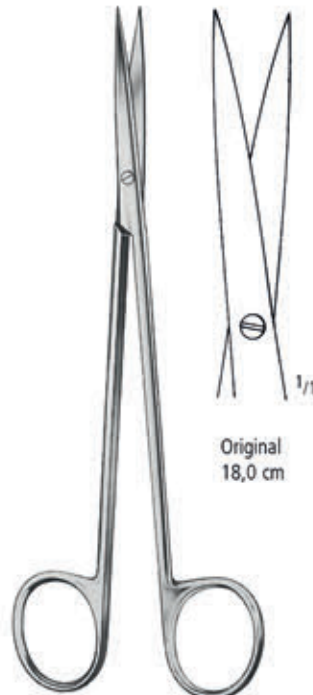

Fig. 3

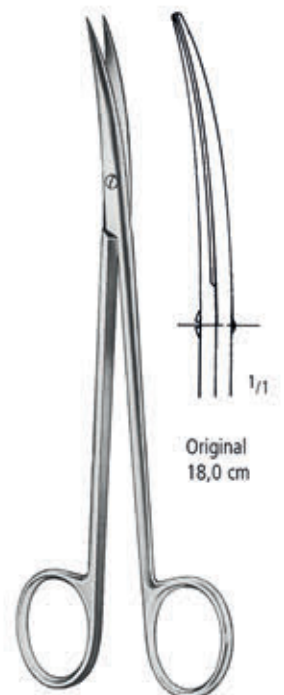

Fig. 3

18,0 cm/7"	AC 150/18	AC 151/18*	AC 152/18	AC 153/18
20,0 cm/8"	AC 150/20	AC 151/20	AC 152/20	AC 153/20
23,0 cm/9"	AC 150/23	AC 151/23	AC 152/23	AC 153/23
25,0 cm/10"			AC 152/25	AC 153/25
28,0 cm/11"			AC 152/28	AC 153/28
30,0 cm/12"			AC 152/30	AC 153/30

SCHEREN SCISSORS TIJERAS CISEAUX FORBICI

Präparierscheren
Dissecting Scissors
Tijeras para preparaciones
Ciseaux à dissection
Forbici per preparazioni

AA

AB

AC

AD

AE

AF

AK

AL

AO

KA

KK

X

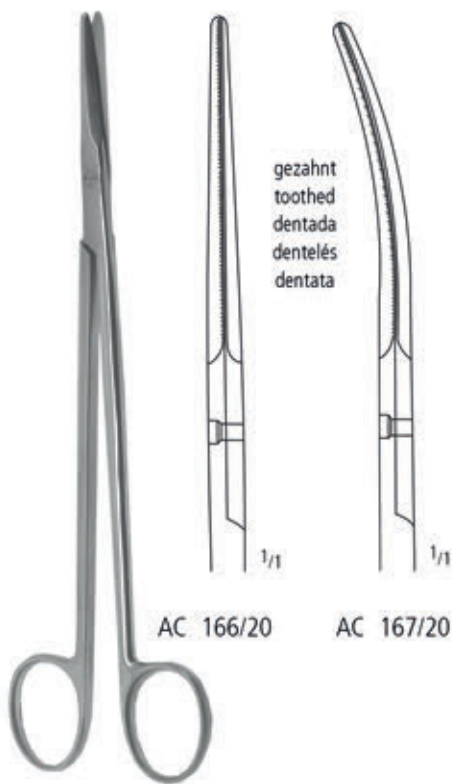

GORNEY
19,5 cm/7³/₄"

Nerv-Präparierschere
Nerve dissecting scissors
Tijeras para nervios
Ciseaux pour nerfs
Forbici per nervi

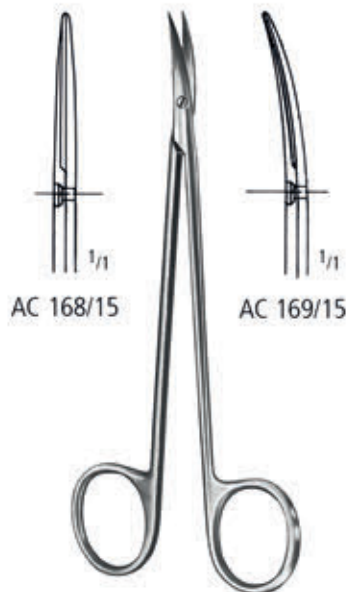

15,0 cm/6"



LEXER
AC 170/16
16,0 cm/6¹/₄"



LEXER
AC 171/16
16,0 cm/6¹/₄"

AC SCHEREN SCISSORS TIJERAS CISEAUX FORBICI

Präparierscheren
Dissecting Scissors
Tijeras para preparaciones
Ciseaux à dissection
Forbici per preparazioni



SANVENERO

AC 200/14
14,0 cm/5 1/2"

AC 201/14
14,0 cm/5 1/2"

JOSEPH

AC 204/14
14,0 cm/5 1/2"

AC 205/14
14,0 cm/5 1/2"



KILNER (RAGNELL)

AC 208/12	12,0 cm/4 3/4"	AC 210/12
AC 208/15	15,0 cm/6"	AC 210/15
AC 208/18	18,0 cm/7"	AC 210/18
AC 208/20	20,0 cm/8"	AC 210/20

REYNOLDS

AC 214/15*	15,0 cm/6"	AC 215/15
AC 214/18*	18,0 cm/7"	AC 215/18

SCHEREN SCISSORS TIJERAS CISEAUX FORBICI

Scheren für Gefäß-Chirurgie
 Scissors for Vascular Surgery
 Tijeras para cirugía vasculares
 Ciseaux pour chirurgie vasculaire
 Forbici per chirurgia vascolare



25°

AC 219/25



25°

AC 220/16 16,0 cm/6 1/4"
 AC 220/19 19,0 cm/7 1/2"
 AC 220/23 23,0 cm/9"
 AC 220/28 28,0 cm/11"



45°

AC 219/45

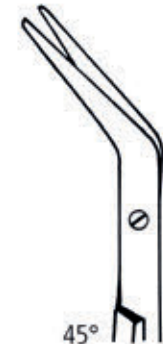

45°

AC 221/16 16,0 cm/6 1/4"
 AC 221/19 19,0 cm/7 1/2"
 AC 221/23 23,0 cm/9"
 AC 221/28 28,0 cm/11"

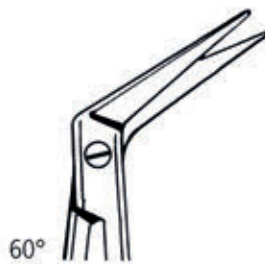

60°

AC 219/60

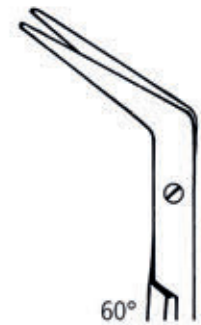

60°

AC 222/16 16,0 cm/6 1/4"
 AC 222/19 19,0 cm/7 1/2"
 AC 222/23 23,0 cm/9"
 AC 222/28 28,0 cm/11"

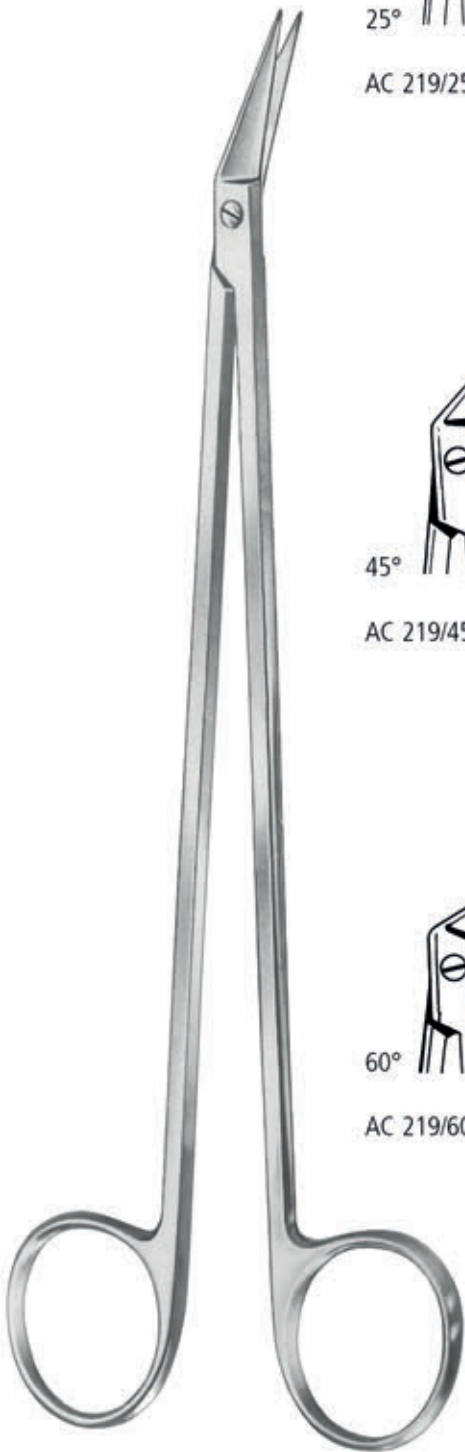

POTT-SMITH
 19,0 cm/7 1/2"



DE BAKEY

AA
 AB
 AC
 AD
 AE
 AF
 AK
 AL
 AO
 KA
 KK
 X

AC SCHEREN SCISSORS TIJERAS CISEAUX FORBICI

Scheren für Gefäß-Chirurgie
 Scissors for Vascular Surgery
 Tijeras para cirugía vasculares
 Ciseaux pour chirurgie vasculaire
 Forbici per chirurgia vascolare

	 25° AC 223/01 18,0 cm/7" AC 224/01 19,0 cm/7 1/2"	
	 45° AC 223/02 18,0 cm/7" AC 224/02 19,0 cm/7 1/2"	
	 60° AC 223/03 17,5 cm/7" AC 224/03 19,0 cm/7 1/2"	
	 90° AC 223/04 17,0 cm/6 3/4" AC 224/04 19,0 cm/7 1/2"	
	 125° AC 223/05 17,0 cm/6 3/4" AC 224/05 19,0 cm/7 1/2"	
 18,0 cm/7"	<p>HEGEMANN-DIETRICH</p>	 AC 225/19 19,0 cm/7 1/2"

SCHEREN SCISSORS TIJERAS CISEAUX FORBICI

Scheren für Gefäß- und Neurochirurgie
 Scissors for Vascular and Neuro Surgery
 Tijeras para cirugía vasculares y neurocirugía
 Ciseaux pour chirurgie vasculaire et neurochirurgie
 Forbici vascolari, Forbici per neurochirurgia

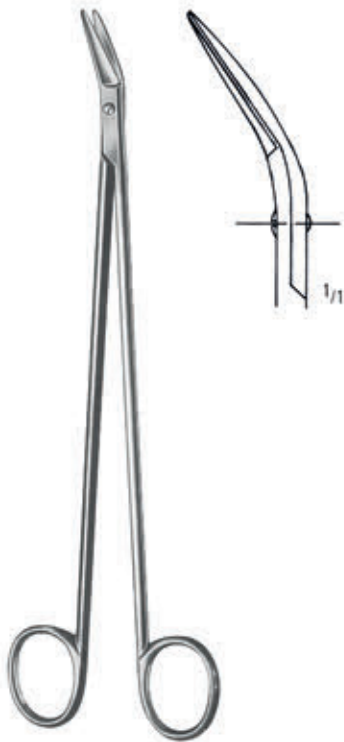

POTTS-SMITH
 AC 227/19
 19,5 cm/7³/₄"

Coronar-Schere
 Coronary-Scissors
 Tijeras coronarias
 Ciseaux coronaires
 Forbici coronaria



AC 228/11
 11,5 cm/4¹/₂"



AC 230/14
 14,5 cm/5³/₄"

geknüpft
 probe pointed
 con botón
 boutonne
 bottenuto



AC 231/22
 22,0 cm/8³/₄"

STRULLY



AC 232/22
 22,0 cm/8³/₄"



DANDY
 AC 233/17
 17,0 cm/6³/₄"

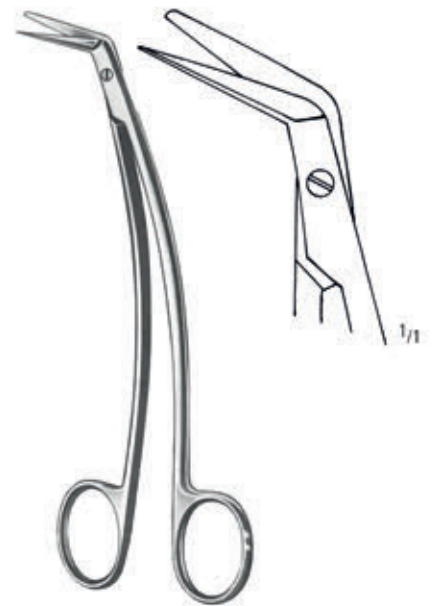

FAVALORO
 AC 234/15
 15,0 cm/6"

AA
 AB
 AC
 AD
 AE
 AF
 AK
 AL
 AO
 KA
 KK
 X

AC SCHEREN SCISSORS TIJERAS CISEAUX FORBICI

Scheren für Gefäß- und Neurochirurgie
 Scissors for Vascular and Neuro Surgery
 Tijeras para cirugía vasculares y neurocirugía
 Ciseaux pour chirurgie vasculaire et neurochirurgie
 Forbici vascolari, Forbici per neurochirurgia

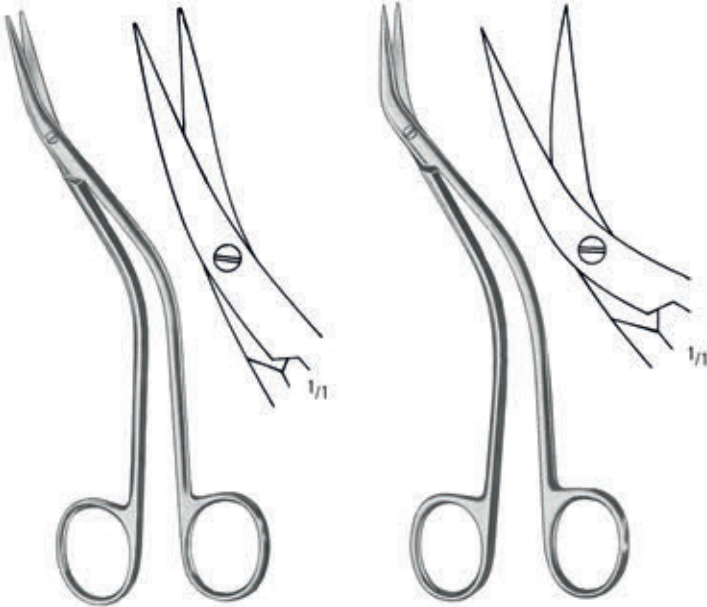

DE BAKKEY

AC 235/15
 15,5 cm/6"

AC 236/15
 15,5 cm/6"



POTTS-DE MARTEL

AC 237/21
 21,0 cm/8¹/₄"

MILLS

AC 238/21
 21,0 cm/8¹/₄"



SCHMIEDEN-TAYLOR

14,5 cm/5¹/₂" AC 241/15
 17,0 cm/6³/₄" AC 241/17

TOENNIS-ADSON

AC 247/17
 17,5 cm/7"

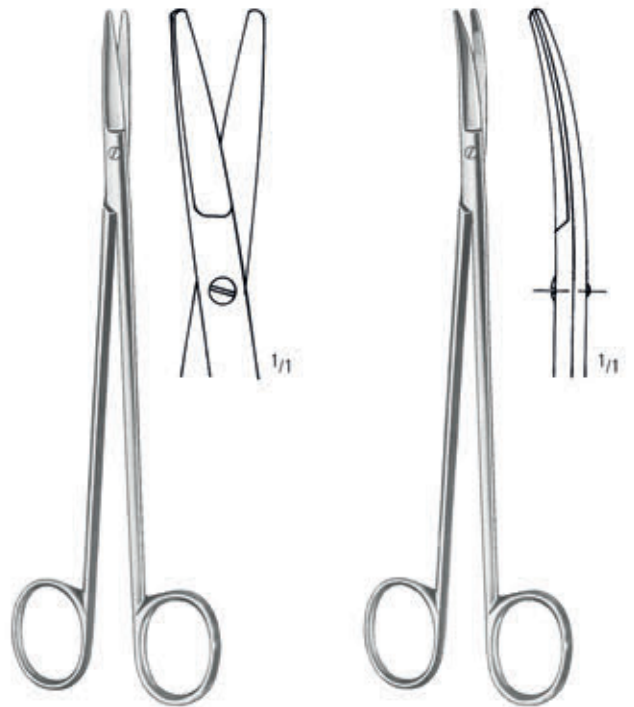

TOENNIS

AC 248/18
 18,0 cm/7"

AC 249/18
 18,0 cm/7"

SCHEREN SCISSORS TIJERAS CISEAUX FORBICI

Scheren für Gefäß- und Neurochirurgie
 Scissors for Vascular and Neuro Surgery
 Tijeras para cirugía vasculares y neurocirugía
 Ciseaux pour chirurgie vasculaire et neurochirurgie
 Forbici vascolari, Forbici per neurochirurgia

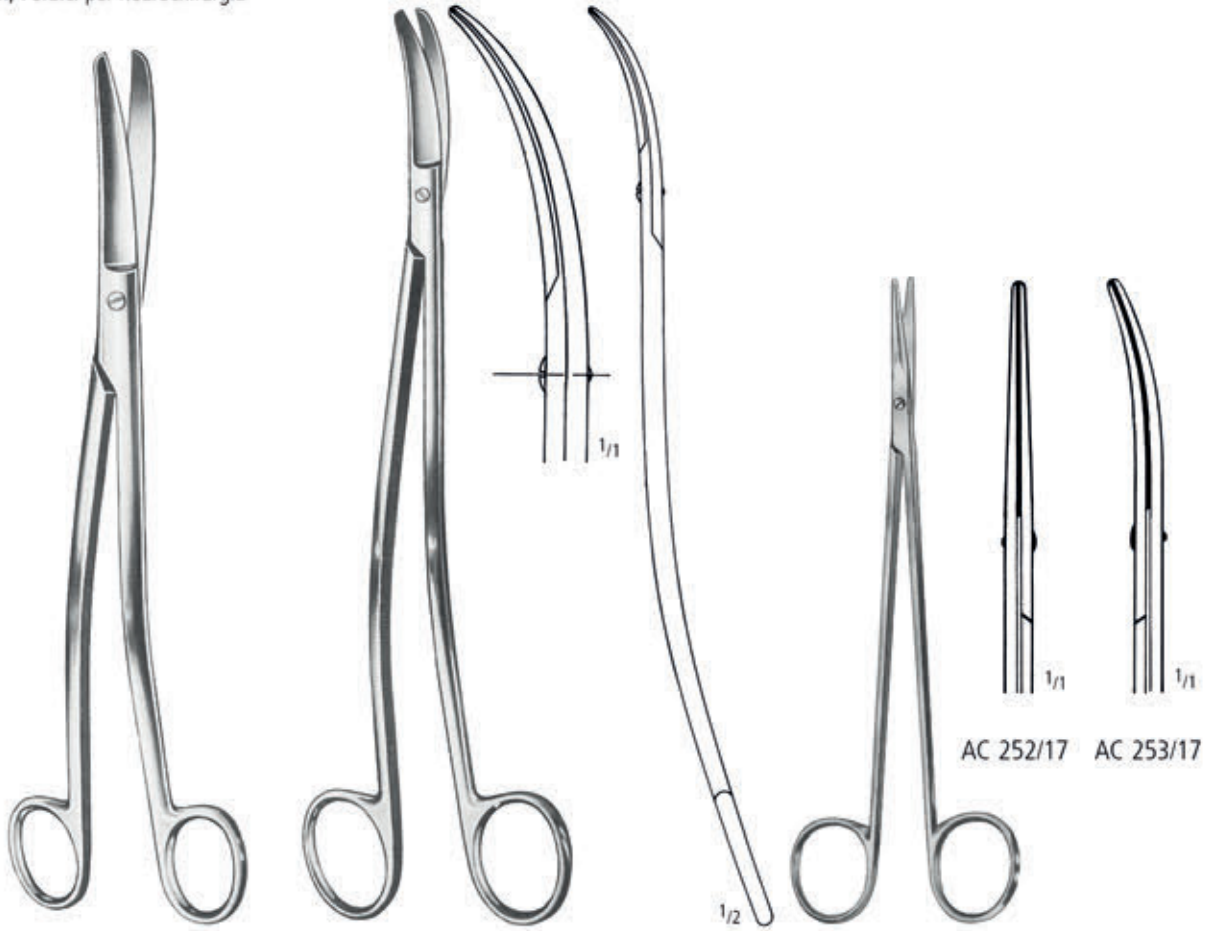

KLINKENBERGH-LOTH
 AC 250/23
 23,0 cm/9"

SATINSKY
 AC 251/24
 24,5 cm/9³/₄"

LINCOLN
 17,0 cm/6³/₄"



FULTON
 AC 255/17
 17,0 cm/6³/₄"



CHURCH
 17,0 cm/6³/₄"

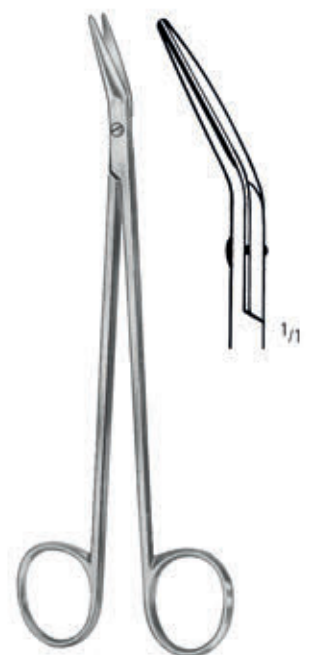

CLASSON
 AC 258/17
 17,0 cm/6³/₄"

AA
 AB
AC
 AD
 AE
 AF
 AK
 AL
 AO
 KA
 KK
 X

AC SCHEREN SCISSORS TIJERAS CISEAUX FORBICI

Knorpel-, Lungenlappen-, Darm- und Anatomiescheren
 Cartilage-, Lobectomy-, Enterotomy- and Dissecting Scissors
 Tijeras para cartilago, lobectomia, enterótomos y disección
 Ciseaux pour le cartilage, à lobectomie, à épisiotomie et à préparation
 Forbici per cartilagini, lobectomia, episiotomia e anatomia



MARTIN-CARTILAGE
 AC 275/20
 20,0 cm/8"

MC INDOE
 AC 276/19
 19,0 cm/7½"

POTTS-SMITH
 AC 277/19
 19,0 cm/7½"

CRAFOORD
 AC 280/30
 30,0 cm/12"

FINOCHIETTO
 AC 281/27
 27,0 cm/10¾"

SCHEREN SCISSORS TIJERAS CISEAUX FORBICI

Feine Scheren
Fine Scissors
Tijeras finas
Ciseaux fins
Forbici fini

AA
AB
AC
AD
AE
AF
AK
AL
AO
KA
KK
X

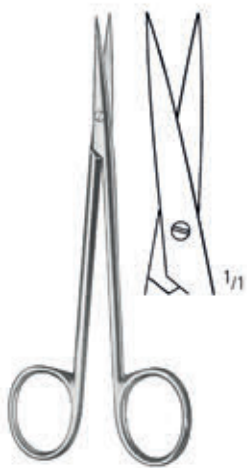

AC 410/11
11,5 cm/4 1/2"



AC 411/11
11,5 cm/4 1/2"



LITTLER
AC 412/11 11,5 cm/4 1/2"
AC 412/14 14,0 cm/5 1/2"



BROPHY (SULLIVAN)
AC 414/14
14,5 cm/5 3/4"



AC 415/14
14,5 cm/5 3/4"

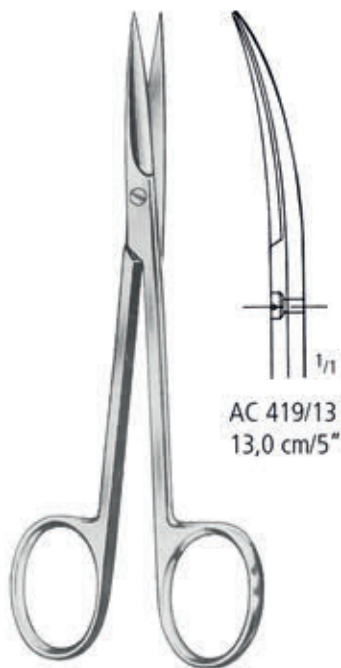

AC 418/13
13,0 cm/5"



AC 422/10
AC 422/11



10,5 cm/4 1/4"
11,5 cm/4 1/2"
AC 423/10
AC 423/11



AC 424/11
11,5 cm/4 1/2"

AC SCHEREN SCISSORS TIJERAS CISEAUX FORBICI

Feine Scheren
 Fine Scissors
 Tijeras finas
 Ciseaux fins
 Forbici fini

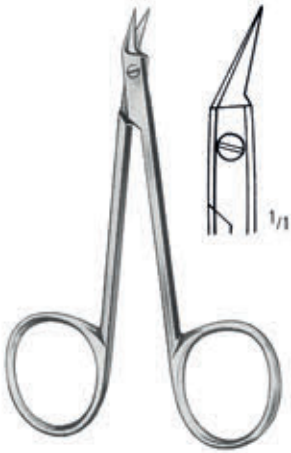

O'BRIEN
 AC 427/09
 9,0 cm/3 1/2"



WALTON
 AC 429/10
 10,0 cm/4"

sehr fein
 extra delicate
 muy finas
 très fin
 molto sottile



AC 430/08
 8,0 cm/3"

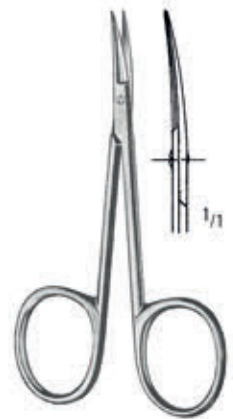

MOD. BONN
 AC 431/08
 8,0 cm/3"



LANDOLT
 AC 434/12
 12,5 cm/5"



LANDOLT
 AC 435/12
 12,5 cm/5"

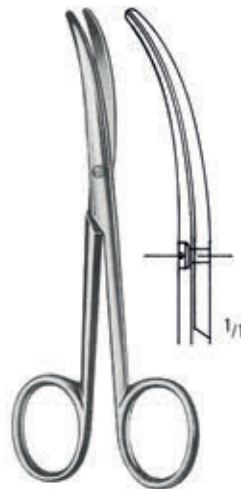

LANDOLT
 AC 436/12
 12,5 cm/5"



LANDOLT
 AC 437/12
 12,5 cm/5"

SCHEREN SCISSORS TIJERAS CISEAUX FORBICI

Feine Scheren
Fine Scissors
Tijeras finas
Ciseaux fins
Forbici fini

AA
AB
AC
AD
AE
AF
AK
AL
AO
KA
KK
X



11,5 cm/4 1/2"

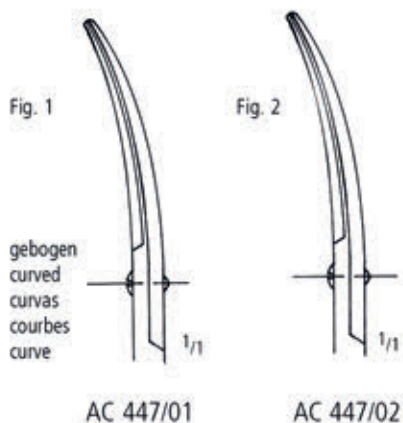
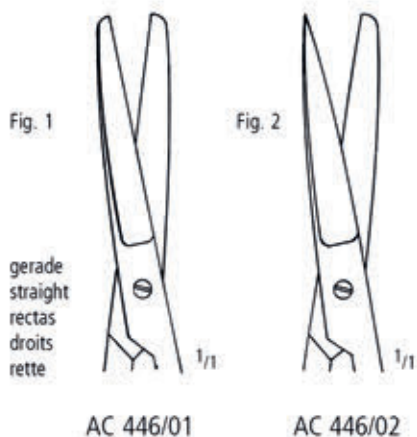

Irisscheren
Iris Scissors
Tijeras para iridectomia
Ciseaux à iridectomie
Forbici per iridectomia

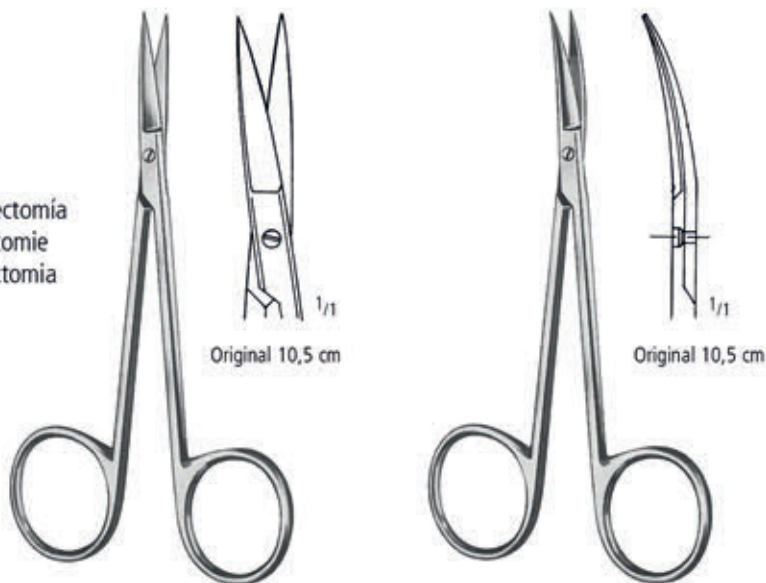

9,0 cm/3 1/2"	AC 450/09	AC 451/09
10,5 cm/4 1/4"	AC 450/10	AC 451/10
11,5 cm/4 1/2"	AC 450/11*	AC 451/11*

* Auch erhältlich als SC * Also available as SC

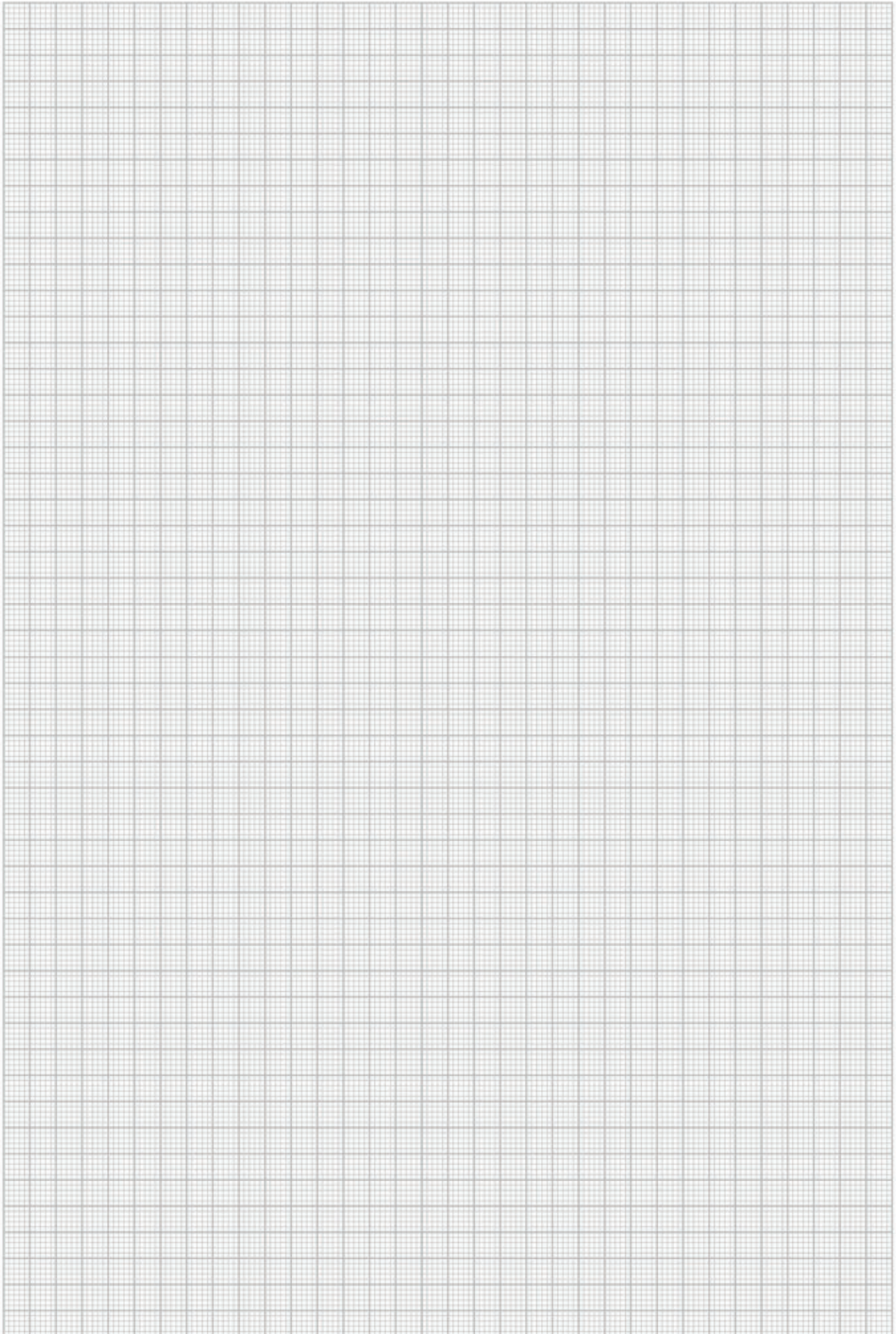

SCHEREN SCISSORS TIJERAS CISEAUX FORBICI

Feine Scheren
 Fine Scissors
 Tijeras finas
 Ciseaux fins
 Forbici fini

Sehnenscheren
 Tenotomy Scissors
 Tijeras para tenotomía
 Ciseaux à ténatomie
 Forbici per tenotomia

Original 11,5 cm

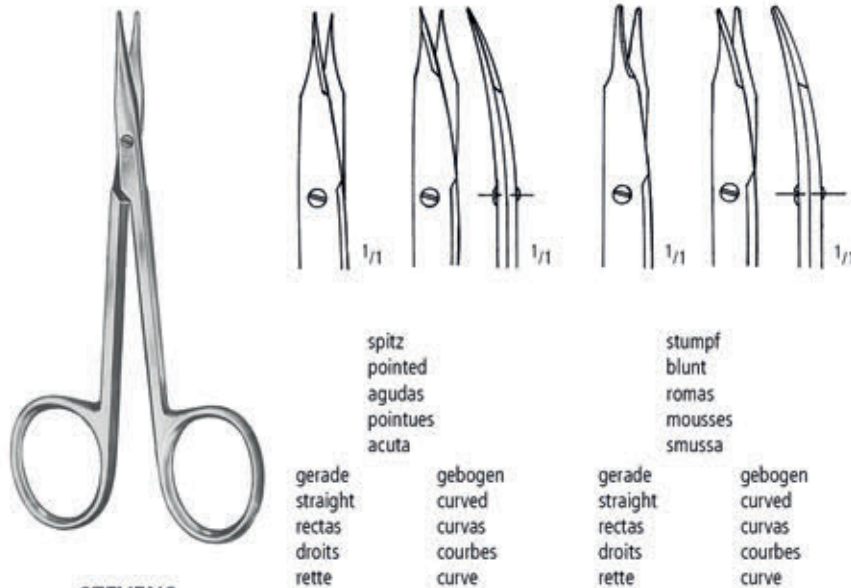

spitz
 pointed
 agudas
 pointues
 acuta

stumpf
 blunt
 romas
 mousses
 smussa

gerade
 straight
 rectas
 droits
 rette

gebogen
 curved
 curvas
 courbes
 curve

gerade
 straight
 rectas
 droits
 rette

gebogen
 curved
 curvas
 courbes
 curve

STEVENS

10,5 cm/4¹/₄"

11,5 cm/4¹/₂"

AC 474/10

AC 474/11

AC 475/10

AC 475/11

AC 476/10

AC 476/11*

AC 477/10

AC 477/11*

AA
 AB
 AC
 AD
 AE
 AF
 AG
 AH
 AI
 AJ
 AK
 AL
 AM
 AN
 AO
 AP
 AQ
 AR
 AS
 AT
 AU
 AV
 AW
 AX

AC SCHEREN SCISSORS TIJERAS CISEAUX FORBICI

Mikroscheren
Micro Scissors
Micro Tijeras
Micro Ciseaux
Micro Forbici

- >> Alle unsere Mikroscheren werden von Fachkräften mit jahrelanger Erfahrung hergestellt. Die Endkontrolle findet unter dem Mikroskop statt. Um Ihnen ein ermüdungsfreies Arbeiten zu ermöglichen, wird dem Federdruck größte Aufmerksamkeit gewidmet.
- >> Bitte wählen Sie unter Rund- oder Flachgriffscheren.

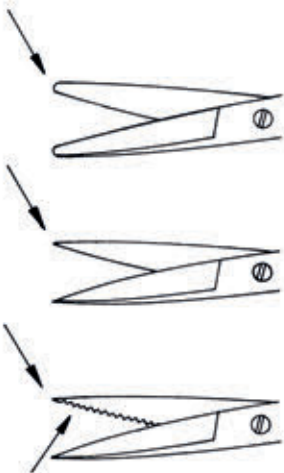

Dissection: **Gebogene Blätter, abgerundete Spitzen** ermöglichen eine gute und sichere Dissektion, ohne Nerven und Blutgefäße zu beschädigen.

Adventitia: **Gerade Blätter, sehr scharfe Spitzen** gewährleisten präzises Anfrischen von Gefäßenden.

Nerve: Ein Blatt ist **fein gezahnt**, um ein Herausgleiten des Nervs zu vermeiden.

- >> All our Micro Scissors are manufactured by skilled craftsmen with many years of experience. Final inspection is carried out under a microscope. Careful attention is paid to the closing pressure of the spring handle, to ensure precise work during surgeries, without fatigue.
- >> Round or flat handle scissors according to your preference.

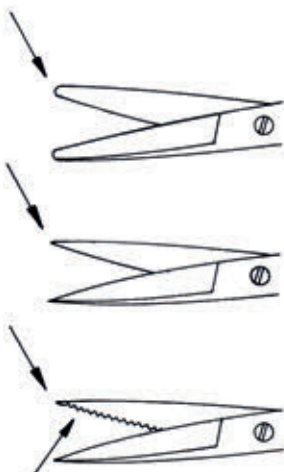

Dissection: **Curved blades, slightly rounded tips** ensure safe dissection without damage to nerves and vessels.

Adventitia: **Straight blades, very sharp tips** for finest trimming of vessel ends.

Nerve: One blade is **fine-toothed** to avoid slipping of the nerve.

SCHEREN SCISSORS TIJERAS CISEAUX FORBICI

Mikroscheren
Micro Scissors
Micro Tijeras
Micro Ciseaux
Micro Forbici

AA

AB

AC

AD

AE

AF

AK

AL

AO

KA

KK

X



14,5 cm/5³/₄"



Dissection
AC 801/15



Adventitia
AC 803/15



18,0 cm/7"



Dissection
AC 801/18



Adventitia
AC 803/18

Mikroscheren
Micro Scissors
Micro Tijeras
Micro Ciseaux
Micro Forbici

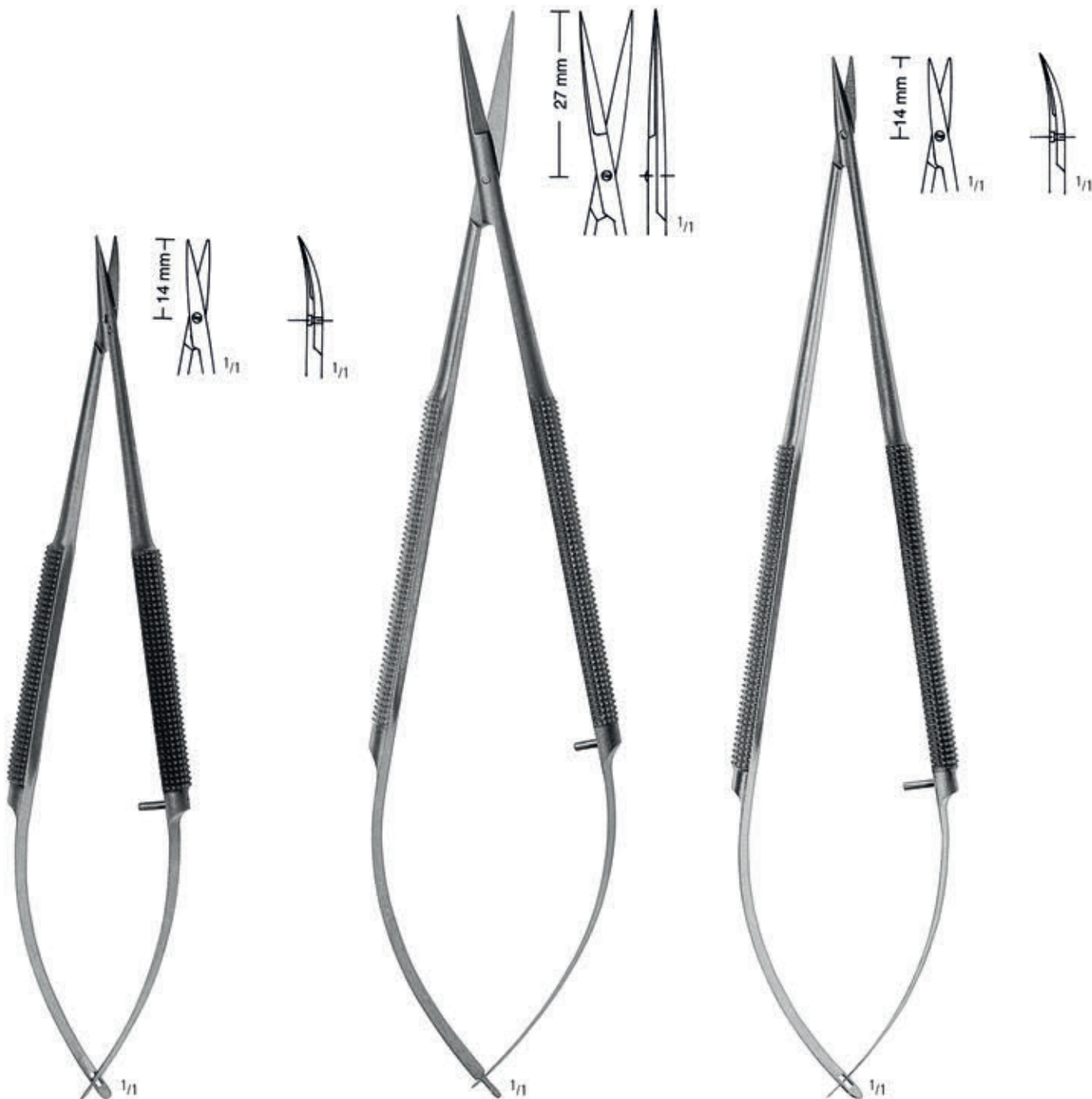

AC 807/14
14,5 cm/5³/₄"

AC 812/18
18,0 cm/7"

AC 817/18
18,0 cm/7"

SCHEREN SCISSORS TIJERAS CISEAUX FORBICI

Mikroscheren
Micro Scissors
Micro Tijeras
Micro Ciseaux
Micro Forbici

AA

AB

AC

AD

AE

AF

AK

AL

AO

KA

KK

X



11,0 cm/4 1/3"

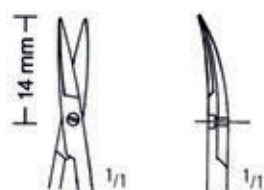

Dissection
AC 821/11

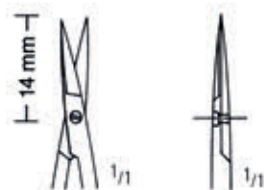

Adventitia
AC 830/11



15,0 cm/6"

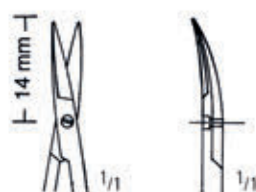

Dissection
AC 823/15



Adventitia
AC 832/15

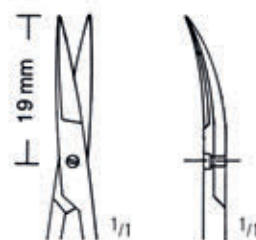

Dissection
AC 825/15



Adventitia
AC 834/15

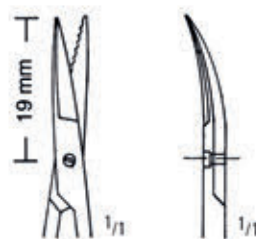

Dissection

>> Nerve >>



Adventitia
AC 836/15



AC SCHEREN SCISSORS TIJERAS CISEAUX FORBICI

Mikroscheren
Micro Scissors
Micro Tijeras
Micro Ciseaux
Micro Forbici



18,5 cm/7 1/8"



AC 850/19



AC 851/19



16,0 cm/6 1/4"
20,0 cm/8"
22,5 cm/9"



AC 860/16
AC 860/20
AC 860/22



AC 861/16
AC 861/20
AC 861/22



AC 862/16
AC 862/20
AC 862/22



AC 863/16
AC 863/20
AC 863/22



AC 864/16
AC 864/20
AC 864/22



AC 865/16
AC 865/20
AC 865/22

SCHEREN SCISSORS TIJERAS CISEAUX FORBICI

Mikroscheren
Micro Scissors
Micro Tijeras
Micro Ciseaux
Micro Forbici



18,0 cm/7"



AC 870/01
25°



AC 870/02
45°



AC 870/03
60°



AC 870/04
90°



AC 870/05
125°



18,0 cm/7"



AC 871/01
25°



AC 871/02
45°



AC 871/03
60°



AC 871/04
90°



AC 871/05
125°

AA
AB
AC
AD
AE
AF
AK
AL
AO
KA
KK
X

Mikroscheren
Micro Scissors
Micro Tijeras
Micro Ciseaux
Micro Forbici



18,0 cm/7"



AC 870/11 T
25°



AC 870/12 T
45°



AC 870/13 T
60°



AC 870/14 T
90°



AC 870/15 T
125°

TITANIUM



18,0 cm/7"



AC 871/11 T
25°



AC 871/12 T
45°



AC 871/13 T
60°



AC 871/14 T
90°



AC 871/15 T
125°

nopa® TUC® SC Super Cut

SUPER CUT TUC



SUPER CUT TUC

Besonderheit:

Nutzen Sie die Vorteile von Hartmetalleinsätzen.

nopa TUC Super Cut Scheren haben eine rasierklingscharfe Schneide, kombiniert mit einer mikrogezahnten Schneide.

>> Diese Scheren sind durch schwarz/goldene Ringe gekennzeichnet.

Features:

Use the advantages of Tungsten Carbide.

nopa TUC Super Cut scissors have a razor-like edge combined with one micro serrated blade.

>> Black/golden rings for easy identification.

Verfügbare Modelle / Available Patterns

Im Katalog durch * markiert. / Marked in catalog with *.

AC 902/14 SC STANDARD SCS. TUC STR. SH/BL 14.5 CM SC
AC 903/14 SC STANDARD SCS. TUC CVD. SH/BL 14.5 CM SC
AC 910/14 SC MAYO DISS.SCS. TUC STR. BL/BL 14.5 CM SC
AC 910/17 SC MAYO DISS.SCS. TUC STR. BL/BL 17.0 CM SC
AC 911/14 SC MAYO DISS. SCS. TUC CVD. BL/BL 14.5 CM SC
AC 911/17 SC MAYO DISS. SCS. TUC CVD. BL/BL 17.0 CM SC
AC 930/14 SC METZENBAUM SCS. TUC STR. BL/BL 14.5 CM SC
AC 931/14 SC METZENBAUM SCS. TUC CVD. BL/BL 14.5 CM SC
AC 940/18 SC METZENBAUM SCS. TUC STR. BL/BL 18.0 CM SC
AC 940/20 SC METZENBAUM SCS. TUC STR. BL/BL 20.0 CM SC
AC 941/18 SC METZENBAUM SCS. TUC CVD. BL/BL 18.0 CM SC
AC 941/20 SC METZENBAUM SCS. TUC CVD. BL/BL 20.0 CM SC
AC 941/23 SC METZENBAUM SCS. TUC CVD. BL/BL 23.0 CM SC
AC 941/25 SC METZENBAUM SCS. TUC CVD. BL/BL 25.0 CM SC
AC 941/28 SC METZENBAUM SCS. TUC CVD. BL/BL 28.0 CM SC
AC 960/14 SC METZENBAUM-DEL.SCS. TUC STR. BL/BL 14.5 CM SC
AC 961/14 SC METZENBAUM-DEL.SCS. TUC CVD. BL/BL 14.5 CM SC
AC 970/18 SC METZENBAUM-DEL.SCS. TUC STR. BL/BL 18.0 CM SC
AC 970/20 SC METZENBAUM-DEL.SCS. TUC STR. BL/BL 20.0 CM SC
AC 971/18 SC METZENBAUM-DEL.SCS. TUC CVD. BL/BL 18.0 CM SC
AC 971/20 SC METZENBAUM-DEL.SCS. TUC CVD. BL/BL 20.0 CM SC
AC 974/11 SC STEVENS TENOTOMY SCS. STR. POINTED 11.5 CM SC
AC 975/11 SC STEVENS TENOTOMY SCS. CVD. POINTED 11.5 CM SC
AC 984/11 SC IRIS SCS. TUC STR. SH/SH 11.5 CM SC
AC 985/11 SC IRIS SCS. TUC CVD. SH/SH 11.5 CM SC

AC SCHEREN SCISSORS TIJERAS CISEAUX FORBICI

Scheren mit Hartmetalleinlagen
 Scissors with Tungsten Carbide Inserts
 Tijeras con filos de carburo de tungsteno
 Ciseaux avec plaquettes en carbure de tungstène
 Forbici con taglio al carburo di tungsteno

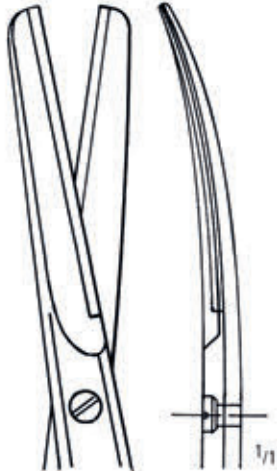

STANDARD
 Fig. 1

straight: 14,5 cm/5³/₄"
 AC 900/14
 curved: AC 901/14

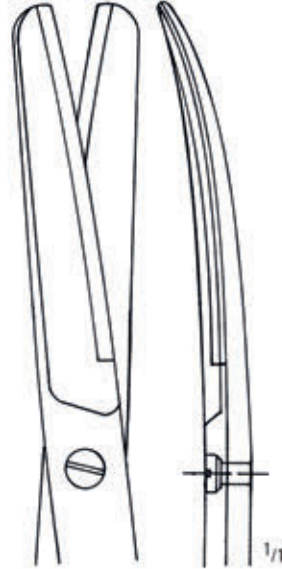

16,5 cm/6¹/₂"
 AC 900/16
 AC 901/16

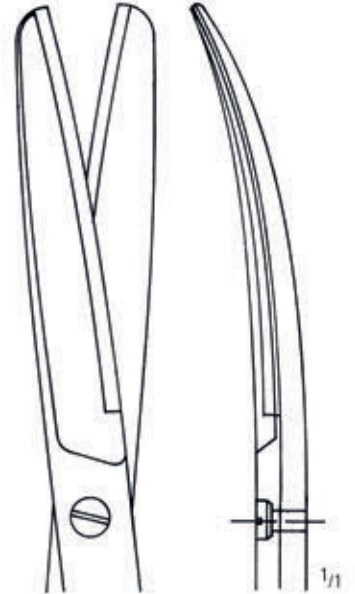

18,5 cm/7¹/₃"
 AC 900/18
 AC 901/18

nopa®
TUC

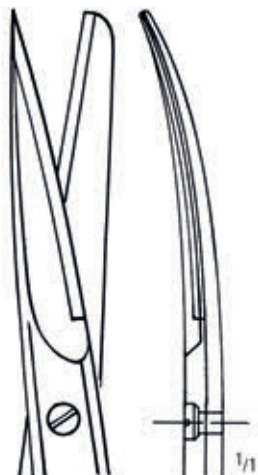

STANDARD
 Fig. 2

straight: 14,5 cm/5³/₄"
 AC 902/14*
 curved: AC 903/14*

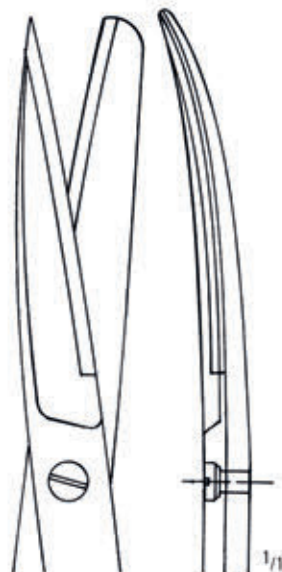

16,5 cm/6¹/₂"
 AC 902/16
 AC 903/16

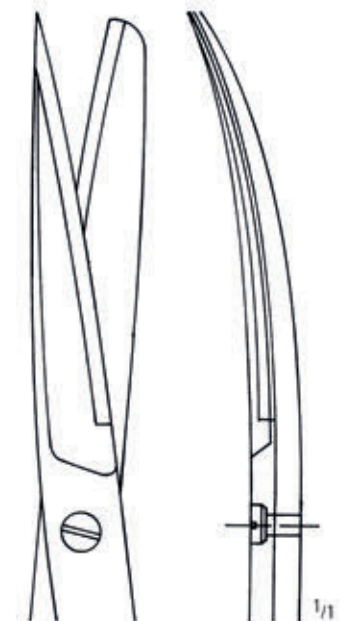

18,5 cm/7¹/₃"
 AC 902/18
 AC 903/18

SCHEREN SCISSORS TIJERAS CISEAUX FORBICI

Scheren mit Hartmetalleinlagen
 Scissors with Tungsten Carbide Inserts
 Tijeras con filos de carburo de tungsteno
 Ciseaux avec plaquettes en carbure de tungstène
 Forbici con taglio al carburo di tungsteno

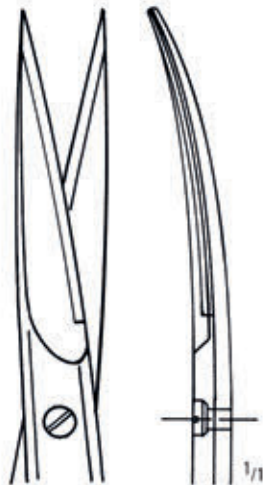

STANDARD
 Fig. 3

straight: 14,5 cm/5³/₄"
 AC 904/14
 curved: AC 905/14

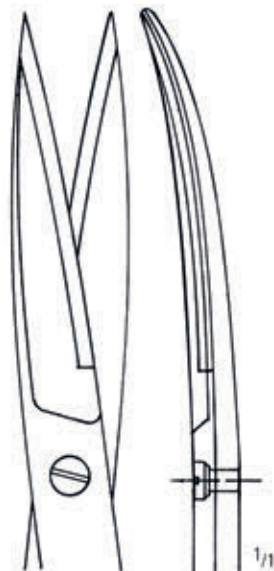

16,5 cm/6¹/₂"
 AC 904/16
 AC 905/16



18,5 cm/7¹/₃"
 AC 904/18
 AC 905/18

nopa®
TUC

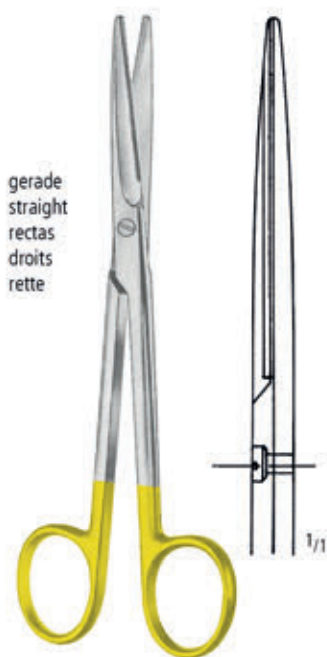

gerade
 straight
 rectas
 droits
 rette



MAYO
 AC 910/14*
 AC 910/17*
 AC 910/23

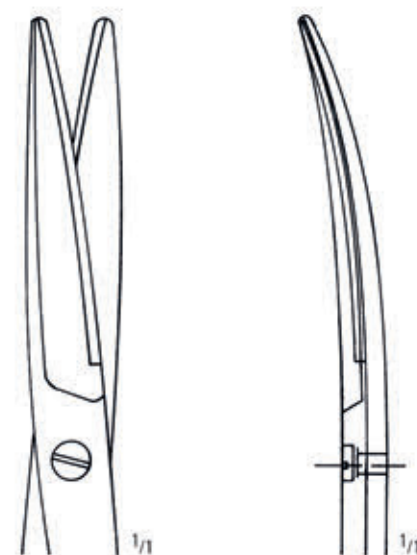

Original 17,0 cm

14,5 cm/5¹/₂"
 17,0 cm/6³/₄"
 23,0 cm/9"



gebogen
 curved
 curvas
 courbes
 curve

MAYO
 AC 911/14*
 AC 911/17*
 AC 911/23

AA
 AB
 AC
 AD
 AE
 AF
 AG
 AH
 AI
 AJ
 AK
 AL
 AM
 AN
 AO
 AP
 AQ
 AR
 AS
 AT
 AU
 AV
 AW
 AX
 AY
 AZ



SCHEREN SCISSORS TIJERAS CISEAUX FORBICI

Scheren mit Hartmetalleinlagen
 Scissors with Tungsten Carbide Inserts
 Tijeras con filos de carburo de tungsteno
 Ciseaux avec plaquettes en carbure de tungstène
 Forbici con taglio al carburo di tungsteno

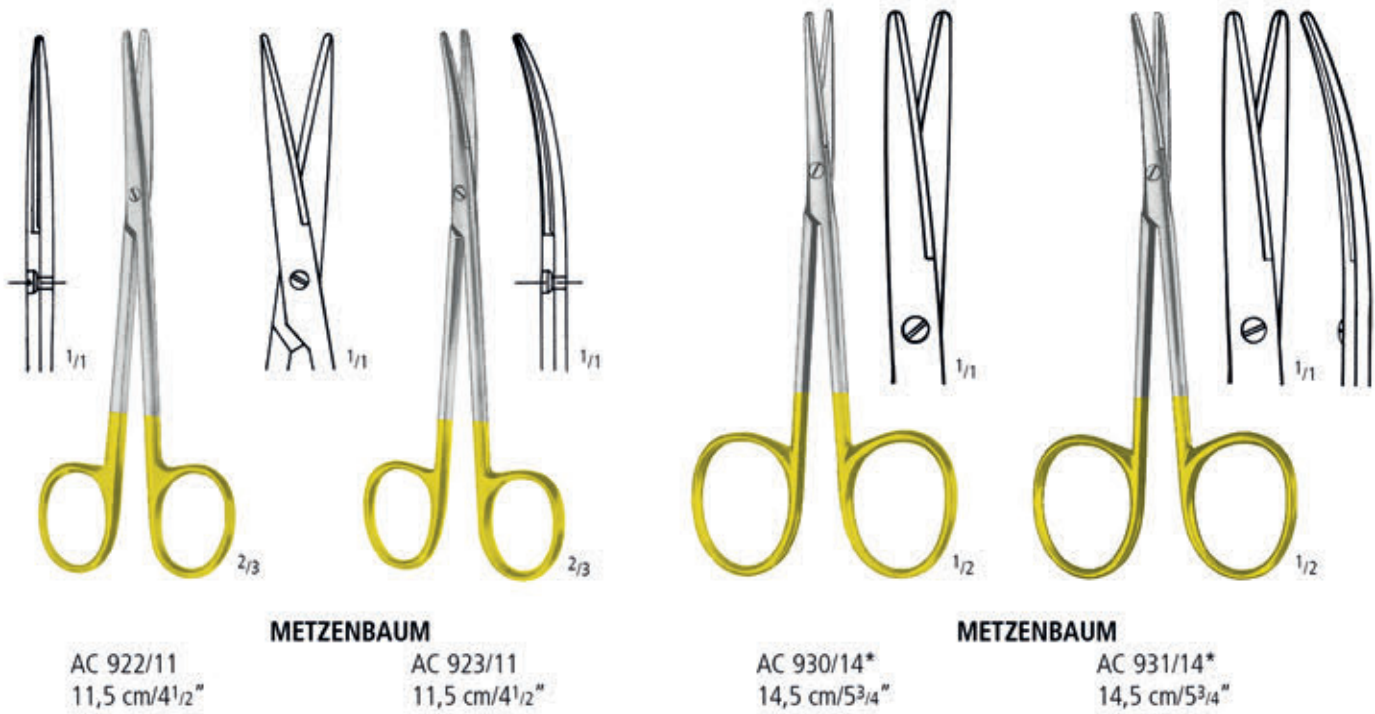

AC SCHEREN SCISSORS TIJERAS CISEAUX FORBICI

Scheren mit Hartmetalleinlagen
 Scissors with Tungsten Carbide Inserts
 Tijeras con filos de carburo de tungsteno
 Ciseaux avec plaquettes en carbure de tungstène
 Forbici con taglio al carburo di tungsteno

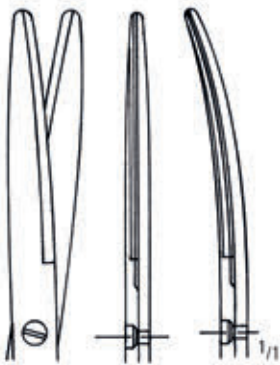

Original 18,0 cm

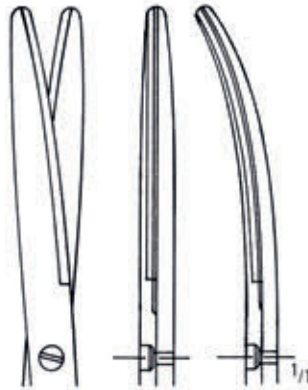

Original 20,0 cm

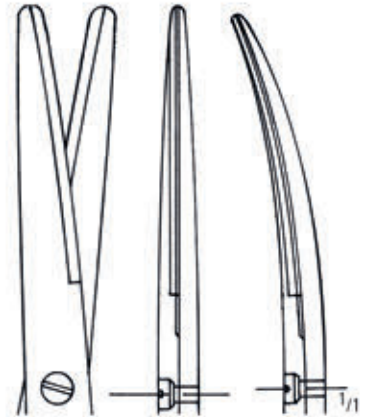

Original 23,0 cm



METZENBAUM

nopa®
TUC

gerade
 straight
 rectas
 droits
 rette

gebogen
 curved
 curvas
 courbes
 curve

AC 940/18*	18,0 cm/7"	AC 941/18*
AC 940/20*	20,0 cm/8"	AC 941/20*
AC 940/23	23,0 cm/9"	AC 941/23*
AC 940/25	25,0 cm/10"	AC 941/25*
AC 940/28	28,0 cm/11"	AC 941/28*
AC 940/30	30,0 cm/12"	AC 941/30

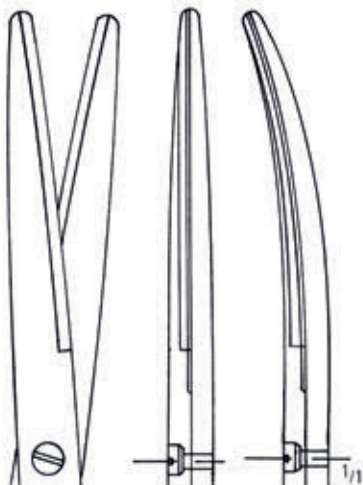

Original 25,0 cm

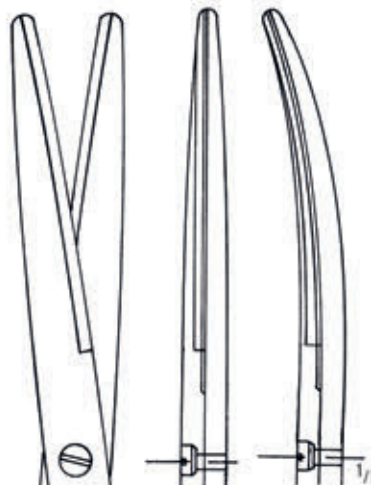

Original 28,0 cm

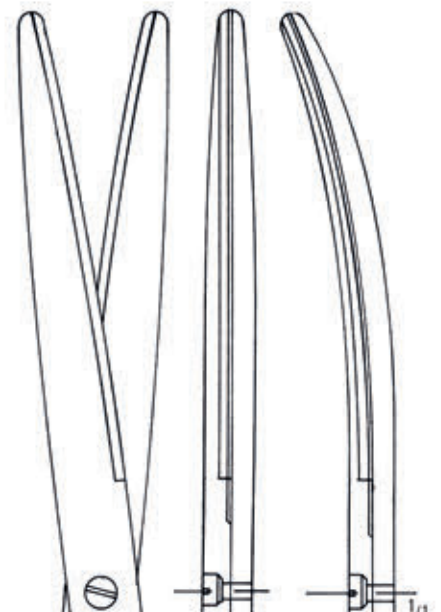

Original 30,0 cm

SCHEREN SCISSORS TIJERAS CISEAUX FORBICI

Scheren mit Hartmetalleinlagen
 Scissors with Tungsten Carbide Inserts
 Tijeras con filos de carburo de tungsteno
 Ciseaux avec plaquettes en carbure de tungstène
 Forbici con taglio al carburo di tungsteno

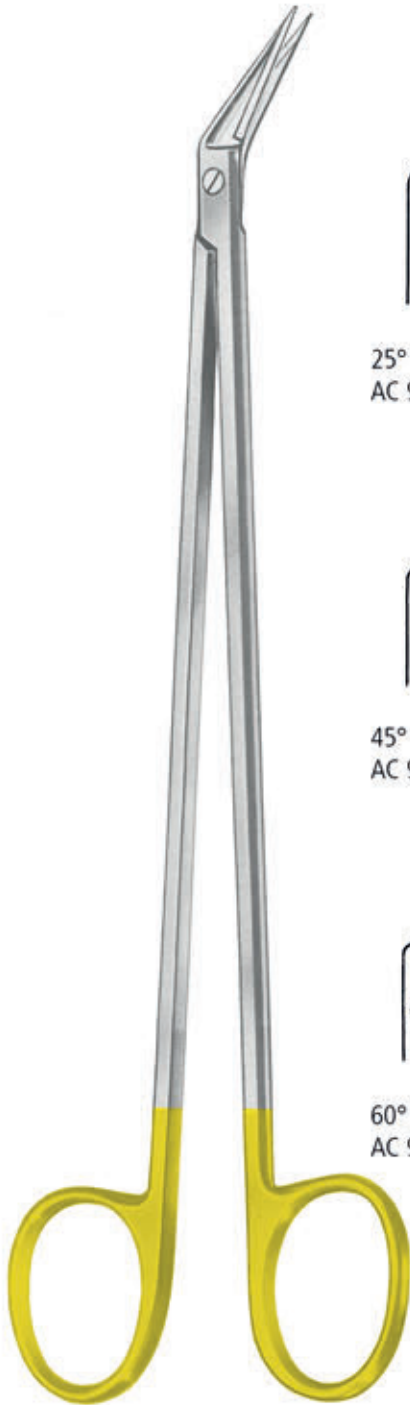

25°
 AC 948/25

45°
 AC 948/45

60°
 AC 948/60

POTT-SMITH
 19,0 cm/7½"



25°
 AC 949/25

45°
 AC 949/45

60°
 AC 949/60

DE BAKKEY
 18,0 cm/7"

AA
 AB
 AC
 AD
 AE
 AF
 AK
 AL
 AO
 KA
 KK
 X

AC SCHEREN SCISSORS TIJERAS CISEAUX FORBICI

Scheren mit Hartmetalleinlagen
 Scissors with Tungsten Carbide Inserts
 Tijeras con filos de carburo de tungsteno
 Ciseaux avec plaquettes en carbure de tungstène
 Forbici con taglio al carburo di tungsteno



LEXER
 AC 952/16
 16,0 cm/6¹/₄"



LEXER
 AC 953/16
 16,0 cm/6¹/₄"

nopa[®]
TUC



AC 960/14*
 14,5 cm/5³/₄"



AC 961/14*
 14,5 cm/5³/₄"



METZENBAUM-DELICATE
 AC 962/14
 14,5 cm/5³/₄"



AC 963/14
 14,5 cm/5³/₄"

SCHEREN SCISSORS TIJERAS CISEAUX FORBICI

Scheren mit Hartmetalleinlagen
 Scissors with Tungsten Carbide Inserts
 Tijeras con filos de carburo de tungsteno
 Ciseaux avec plaquettes en carbure de tungstène
 Forbici con taglio al carburo di tungsteno

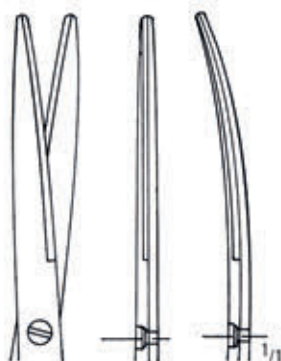

Original 18,0 cm

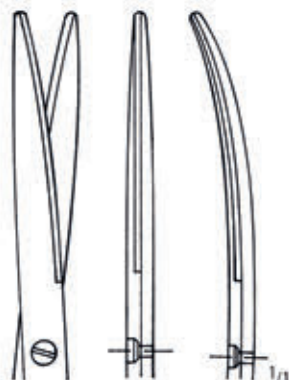

Original 20,0 cm

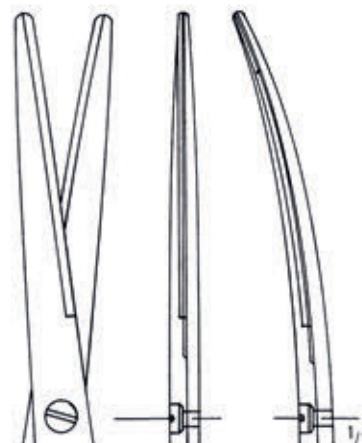

Original 23,0 cm



METZENBAUM-DELICATE

nopa®
TUC

gerade
 straight
 rectas
 droits
 rette

gebogen
 curved
 curvas
 courbes
 curve

AC 970/18*	18,0 cm/7"	AC 971/18*
AC 970/20*	20,0 cm/8"	AC 971/20*
AC 970/23	23,0 cm/9"	AC 971/23
AC 970/25	25,0 cm/10"	AC 971/25
AC 970/28	28,0 cm/11"	AC 971/28

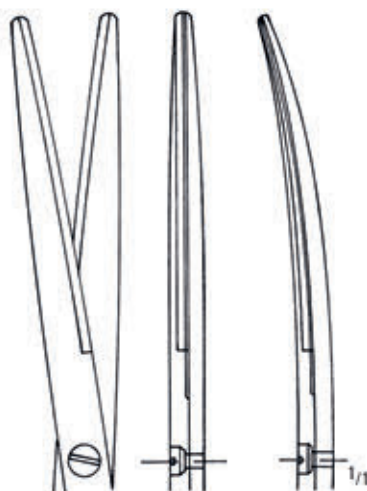

Original 25,0 cm

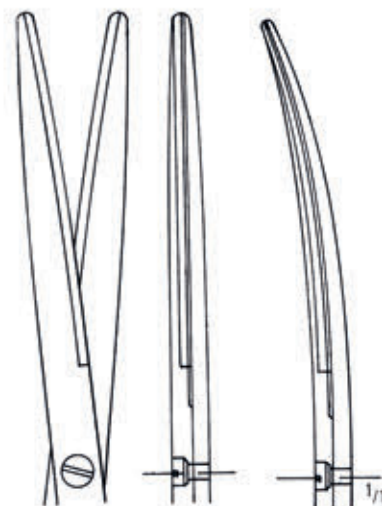

Original 28,0 cm

AA
 AB
AC
 AD
 AE
 AF
 AK
 AL
 AO
 KA
 KK
 X

AC SCHEREN SCISSORS TIJERAS CISEAUX FORBICI

Scheren mit Hartmetalleinlagen
 Scissors with Tungsten Carbide Inserts
 Tijeras con filos de carburo de tungsteno
 Ciseaux avec plaquettes en carbure de tungstène
 Forbici con taglio al carburo di tungsteno

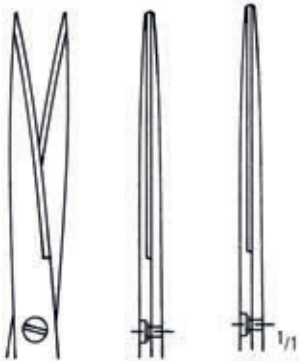

Original 18,0 cm

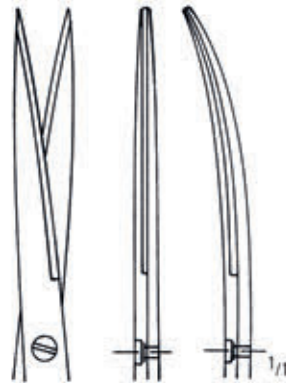

Original 20,0 cm

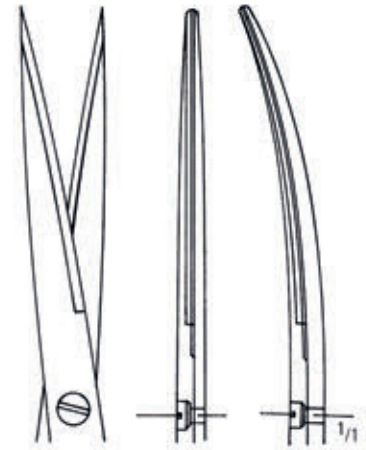

Original 23,0 cm



METZENBAUM-DELICATE

nopa®
TUC

gerade
 straight
 rectas
 droits
 rette

gebogen
 curved
 curvas
 courbes
 curve

AC 972/18	18,0 cm/7"	AC 973/18
AC 972/20	20,0 cm/8"	AC 973/20
AC 972/23	23,0 cm/9"	AC 973/23
AC 972/25	25,0 cm/10"	AC 973/25
AC 972/28	28,0 cm/11"	AC 973/28

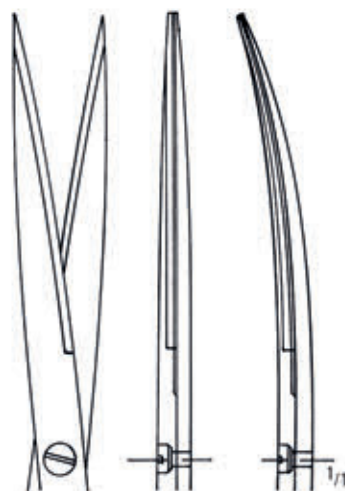

Original 25,0 cm

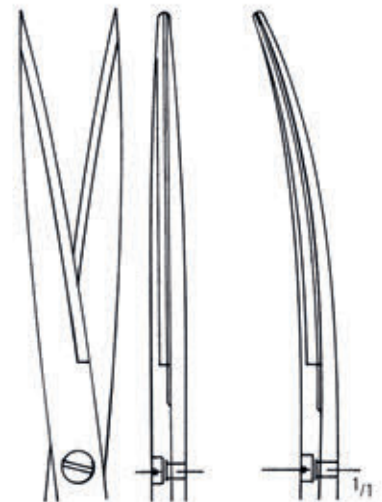

Original 28,0 cm

SCHEREN SCISSORS TIJERAS CISEAUX FORBICI

Scheren mit Hartmetalleinlagen
 Scissors with Tungsten Carbide Inserts
 Tijeras con filos de carburo de tungsteno
 Ciseaux avec plaquettes en carbure de tungstène
 Forbici con taglio al carburo di tungsteno



Original 11,5 cm

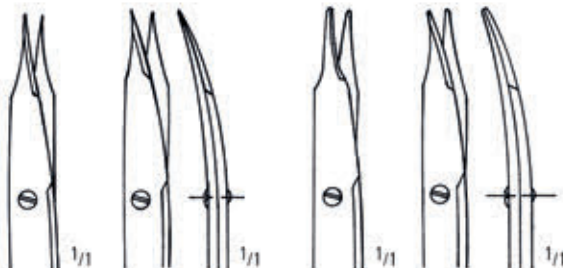

	spitz pointed agudas pointues acuta		stumpf blunt romas mousses smussa
gerade straight rectas droits rette	gebogen curved curvas courbes curve	gerade straight rectas droits rette	gebogen curved curvas courbes curve

STEVENS

10,5 cm/4 1/4"
 11,5 cm/4 1/2"

AC 974/10	AC 975/10	AC 976/10	AC 977/10
AC 974/11*	AC 975/11*	AC 976/11	AC 977/11

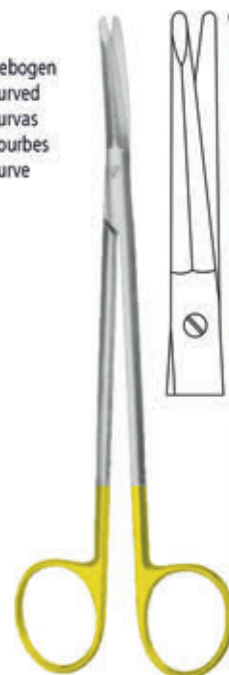
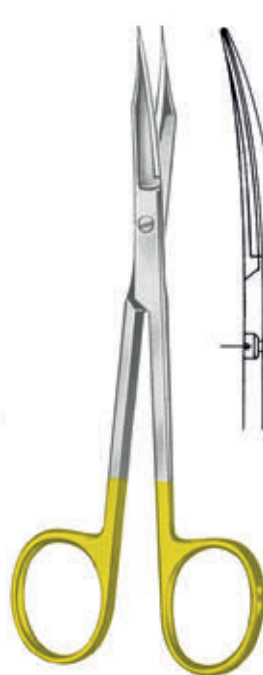

gebogen
curved
curvas
courbes
curve

gezahnt
toothed
dentada
dentelés
dentata

TOENNIS-ADSON-DELICATE

AC 977/17
 17,5 cm/7"

GOLDMAN-FOX

AC 980/13
 13,0 cm/5"

AC 981/13
 13,0 cm/5"

KAYE

AC 983/15
 15,0 cm/6"

* Auch erhältlich als SC * Also available as SC

AA
 AB
 AC
 AD
 AE
 AF
 AG
 AH
 AI
 AJ
 AK
 AL
 AM
 AN
 AO
 AP
 AQ
 AR
 AS
 AT
 AU
 AV
 AW
 AX

Scheren mit Hartmetalleinlagen
 Scissors with Tungsten Carbide Inserts
 Tijeras con filos de carburo de tungsteno
 Ciseaux avec plaquettes en carbure de tungstène
 Forbici con taglio al carburo di tungsteno

nopa®
TUC



AC 984/11*
 11,5 cm/4 1/2"



AC 985/11*
 11,5 cm/4 1/2"

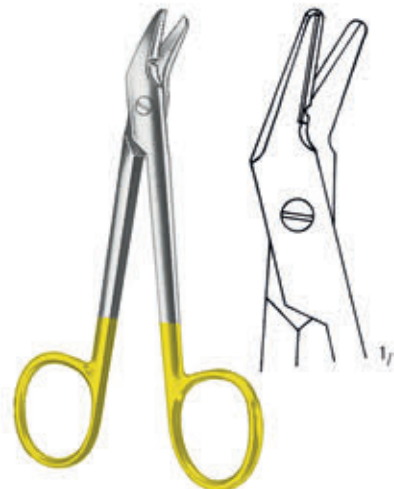

UNIVERSAL
 AC 987/12
 12,0 cm/4 3/4"



LISTER
 AC 999/18
 18,0 cm/7"

SKALPELLE
SCALPELS
BISTURIES
BISTOURIS
BISTURI

AD

nopa[®] instruments

Weitere Skalpelle finden Sie in unserem Katalog „Allgemeine Chirurgie“ in Gruppe AD.

For further scalpels kindly refer to our catalogue „General Surgery“, section AD.

Para bisturías adicionales, por favor consulte nuestro catálogo de „Cirugía general“, grupo AD.

Pour des bistouris supplémentaires, consultez notre catalogue „Chirurgie Generale“, section AD.

Per gli altri bisturi, consultare il nostro catalogo „Chirurgia Generale“, gruppo AD.



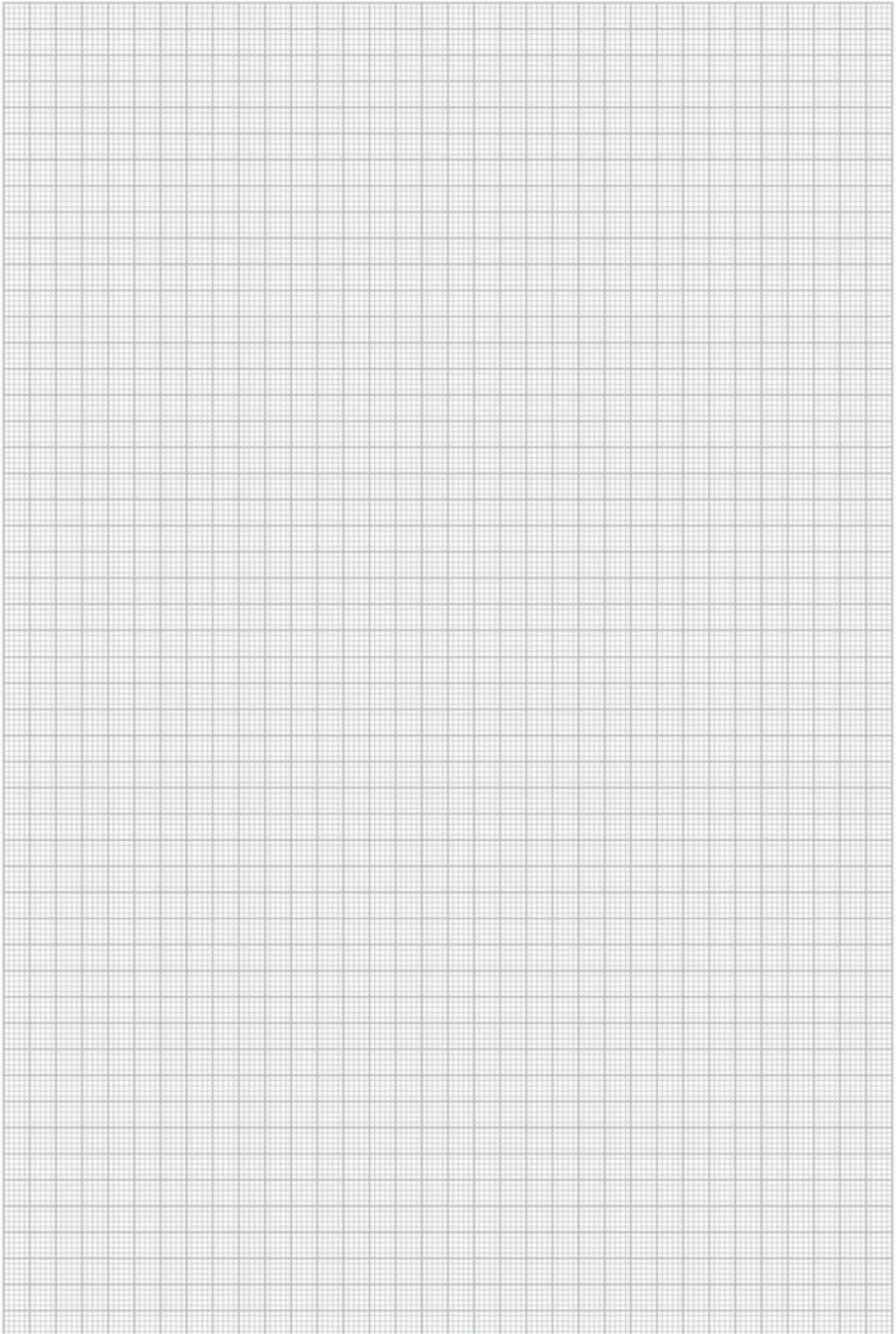

SKALPELLE SCALPELS BISTURIES BISTOURIS BISTURI

Skalpellgriffe
 Scalpel Handles
 Mangos de bisturías
 Manches pour bistouris
 Manici per bisturi

AA
 AB
 AC
AD
 AE
 AF
 AK
 AL
 AO
 KA
 KK
 X



AD 009/03
 No. 3



AD 010/03
 No. 3



AD 010/04
 No. 4



AD 010/05
 No. 5K



AD 020/13
 No. 3L



AD 020/14
 No. 4L



AD 020/15
 No. 5L

AD SKALPELLE SCALPELS BISTURIES BISTOURIS BISTURI

Skalpellgriffe
 Scalpel Handles
 Mangos de bisturías
 Manches pour bistouris
 Manici per bisturi



AD 025/07
 No. 7



AD 027/07
 No. 7K



AD 030/16



AD 031/21



COLLIN
 AD 040/08
 No. 8

hohl
 hollow
 hueco
 creux
 vuoto



COLLIN
 AD 042/09
 No. 9

Skalpellgriffe, Skalpellklingen
 Scalpel Handles, Scalpel Blades
 Mangos de bisturios, Hojas de bisturios
 Manches pour bistouris, Lames de bistouris
 Manici per bisturi, Lame per bisturi

AA
 AB
 AC
AD
 AE
 AF
 AG
 AH
 AI
 AJ
 AK
 AL
 AM
 AN
 AO
 AP
 AQ
 AR
 AS
 AT
 AU
 AV
 AW
 AX
 AY
 AZ

MINI

Verpackungseinheit / packing unit = 10 St./pc.



Fig. 61
AD 065/61



Fig. 62
AD 065/62



Fig. 62S
AD 065/63



Fig. 64
AD 065/64



Fig. 65
AD 065/65



Fig. 67
AD 065/67



Fig. 69
AD 065/69



AD 065/10

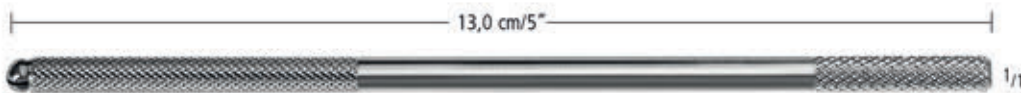

AD 065/13



AD 065/15

AD SKALPELLE SCALPELS BISTURIES BISTOURIS BISTURI

Skalpellklingen
Scalpel Blades
Hojas de bisturias
Lames pour bistouris
Lame per bisturi

passend für die Griffe
for handles
para los mangos
pour les manches
per i manici

- AD 009/03
- AD 010/03
- AD 020/13
- AD 025/07
- AD 027/07
- AD 030/16
- AD 040/08



Fig. 10
AD 075/10



Fig. 11
AD 075/11



Fig. 12d
AD 076/12



Fig. 15
AD 075/15



Fig. 15c
AD 076/15



steril
sterile
estériles
stériles
sterili

passend für die Griffe
for handles
para los mangos
pour les manches
per i manici

- AD 010/04
- AD 020/14
- AD 042/09



Fig. 20
AD 075/20



Fig. 21
AD 075/21



Fig. 22
AD 075/22



Fig. 23
AD 075/23



Fig. 24
AD 075/24

NAHT
SUTURE
SUTURA
SUTURE
SUTURA

AE

nopa[®] instruments

Weitere Naht-Instrumente finden Sie in unserem Katalog „Allgemeine Chirurgie“ in Gruppe AE.

For further suture instruments kindly refer to our catalogue „General Surgery“, section AE.

Para instrumentos de sutura adicionales, por favor consulte nuestro catálogo de „Cirugía general“, grupo AE.

Pour des instruments de suture supplémentaires, consultez notre catalogue „Chirurgie Generale“, section AE.

Per gli altri accessori di sutura, consultare il nostro catalogo „Chirurgia Generale“, gruppo AE.



AE NAHT SUTURE SUTURA SUTURE SUTURA

Hartmetalleinsatzplättchen mit Pyramidenprofil
 Tungsten Carbide Tips with pyramidal profile
 Bocas de carburo de tungsteno con perfil de estructura piramidal
 Plaquettes en carbure de tungstène avec profil pyramidal
 Placche di carburo di tungsteno con profilo in forma piramidale



Teilung:	0,5 mm	Für Nahtmaterial 3/0 und größer
Serration:	0,5 mm	For suture sizes 3/0 and larger
Graduación:	0,5 mm	Para sutura 3/0 y más grande
Graduation:	0,5 mm	Pour suture 3/0 et plus grand
Graduazione:	0,5 mm	Per sutura 3/0 e più grande

"STANDARD"

(Mayo-Hegar, Mathieu, Bozeman,
 New Orleans, Stratte, etc.)

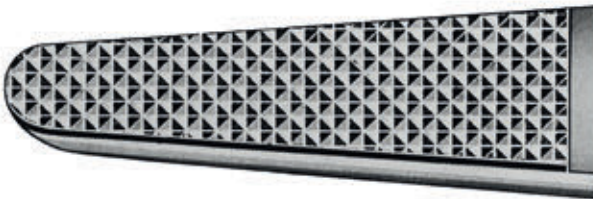

Teilung:	0,4 mm	Für Nahtmaterial zwischen 3/0 und 6/0
Serration:	0,4 mm	For suture sizes between 3/0 and 6/0
Graduación:	0,4 mm	Para suturas entre 3/0 y 6/0
Graduation:	0,4 mm	Pour sutures entre 3/0 et 6/0
Graduazione:	0,4 mm	Per sutura tra 3/0 e 6/0

"FINE"

(Crile-Wood, Halsey, DeBakey, Ryder,
 etc.)



Teilung:	0,2 mm	Für Nahtmaterial zwischen 7/0 und 10/0
Serration:	0,2 mm	For suture sizes between 7/0 and 10/0
Graduación:	0,2 mm	Para suturas entre 7/0 y 10/0
Graduation:	0,2 mm	Pour sutures entre 7/0 et 10/0
Graduazione:	0,2 mm	Per sutura tra 7/0 e 10/0

"MICRO"

(Micro Ryder, Microvascular, Castroviejo,
 etc.)



glatt	Für extrem feines Nahtmaterial
smooth	For the smallest suture sizes available
lisa	Para suturas extremamente finas
lisses	Pour matériel de suture extrêmement fin
liscio	Per materiale di sutura finissima

"SMOOTH"

(Eufrate Pasqué, Castroviejo, Jacobson, etc.)

NAHT SUTURE SUTURA SUTURE SUTURA

nopa-Service, Ersatzteile und Aufarbeitung aller Fabrikate
 nopa-Service, Spare Inserts and Refurbishing of all brands
 Servicio-nopa, piezas de recambio y renovar de todas las marcas
 Service-nopa, pièces de rechange et remise à neuf de toutes les marques
 Servizio-nopa, pezzi di ricambio e riparazione di tutte le marche

TUC-Einsätze
TUC-Inserts
TUC-Bocas
TUC-Plaquettes
TUC-Placche

AE 380/15	Smooth, 15 mm
AE 380/17	Smooth, 17 mm
AE 380/19	Smooth, 19 mm
AE 382/15	Micro, 0.2, 15 mm
AE 382/17	Micro, 0.2, 17 mm
AE 382/19	Micro, 0.2, 19 mm
AE 384/15	Fine, 0.4, 15 mm
AE 384/17	Fine, 0.4, 17 mm
AE 384/19	Fine, 0.4, 19 mm
AE 385/15	Standard, 0.5, 15 mm
AE 385/17	Standard, 0.5, 17 mm
AE 385/19	Standard, 0.5, 19 mm

AA

AB

AC

AD

AE

AF

AK

AL

AO

KA

KK

X



titan instruments

nopa[®] instruments

Besonderheit:

nopa Titan Instrumente bieten insbesondere in der Herz-Thorax-Chirurgie Vorteile gegenüber herkömmlichen Instrumenten. Titan ist ca. 45% leichter als rostfreier Edelstahl, weshalb Titan Instrumente weniger traumatisierend sind. Titan ist außerdem ein vollkommen korrosionsbeständiges und antimagnetisches Material. **nopa** Titan Instrumente bedeuten größtmöglichen Komfort für den Chirurgen.

Features:

nopa Titan Instruments provide especially in Cardiovascular surgery a significant advantage compared to other Instruments. Titan is approximately 45% lighter than stainless steel. For that reason, Titan Instruments are less traumatic. Besides that, Titan is a completely stainless and anti-magnetic material. **nopa** Titan Instruments are the most comfortable choice for the Cardiovascular surgeon.

AE 400/16 T	MAYO-HEGAR NH TUC 16.0 CM
AE 400/18 T	MAYO-HEGAR NH TUC 18.0 CM
AE 400/20 T	MAYO-HEGAR NH TUC 20.0 CM
AE 420/18 T	DE BAKEY NH TUC 18.0 CM
AE 420/20 T	DE BAKEY NH TUC 20.0 CM
AE 420/23 T	DE BAKEY NH TUC 23.0 CM
AE 420/26 T	DE BAKEY NH TUC 26.0 CM
AE 430/15 T	RYDER/FRENCH-EYE NH TUC 15.0 CM
AE 430/18 T	RYDER/FRENCH-EYE NH TUC 18.0 CM
AE 430/20 T	RYDER/FRENCH-EYE NH TUC 20.0 CM
AE 438/18 T	MICROVASCULAR NH TUC 18.0 CM
AE 438/20 T	MICROVASCULAR NH TUC 20.0 CM
AE 438/23 T	MICROVASCULAR NH TUC 23.0 CM
AE 466/13 T	HALSEY NH TUC 13.0 CM
AE 572/14 T	CASTROVIEJO NH TUC STR. RA SER. 14.0 CM
AE 580/02 T	JACOBSON MICRO-NH TUC RA SER. 21.0 CM
AE 632/18 T	MICRO-NH STR. 18.0 CM
AE 633/18 T	MICRO-NH CVD. 18.0 CM









AE NAHT SUTURE SUTURA SUTURE SUTURA

Nadelhalter mit Hartmetalleinsätzen
 Needle Holders with Tungsten Carbide Inserts
 Porta-agujas con bocas de carburo de Tungsteno
 Porte-aiguilles à mors en carbure de tungstène
 Portaghi con placche di carburo di tungsteno



MAYO-HEGAR

				
AE 400/14 14,0 cm/5½"	AE 400/16 16,0 cm/6¼"	AE 400/18 18,0 cm/7"	AE 400/20 20,0 cm/8"	AE 400/24 24,0 cm/9½"
				
			AE 400/26 26,0 cm/10½"	AE 400/30 30,0 cm/12"



**DE-BAKEY
 (MAYO-HEGAR-DELICATE)**

				
AE 420/18 18,0 cm/7"	AE 420/20 20,0 cm/8"	AE 420/23 23,0 cm/9"	AE 420/26 26,0 cm/10½"	AE 420/31 31,0 cm/12¼"

NAHT SUTURE SUTURA SUTURE SUTURA

Nadelhalter mit Hartmetalleinsätzen
 Needle Holders with Tungsten Carbide Inserts
 Porta-agujas con bocas de carburo de Tungsteno
 Porte-aiguilles à mors en carbure de tungstène
 Portaghi con placche di carburo di tungsteno

RYDER/FRENCH-EYE

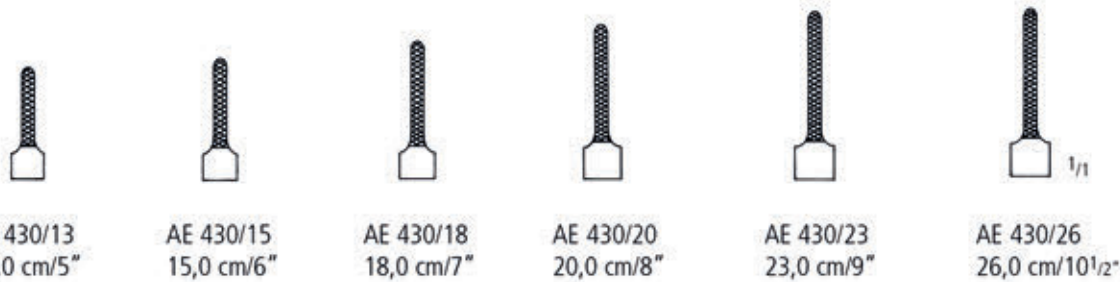

AE 430/13
13,0 cm/5"

AE 430/15
15,0 cm/6"

AE 430/18
18,0 cm/7"

AE 430/20
20,0 cm/8"

AE 430/23
23,0 cm/9"

AE 430/26
26,0 cm/10¹/₂"

MICRO RYDER

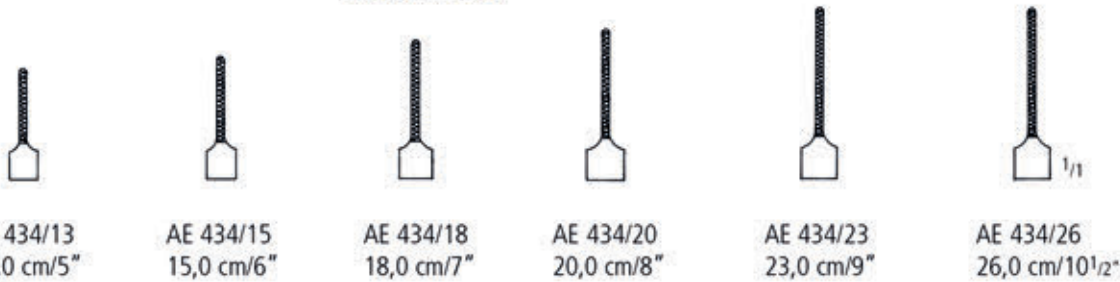

AE 434/13
13,0 cm/5"

AE 434/15
15,0 cm/6"

AE 434/18
18,0 cm/7"

AE 434/20
20,0 cm/8"

AE 434/23
23,0 cm/9"

AE 434/26
26,0 cm/10¹/₂"



AE 436/14
14,0 cm/5¹/₂"

AE 436/18
18,0 cm/7"

AE 436/20
20,0 cm/8"

AE 436/23
23,0 cm/9"



AE 438/14
14,0 cm/5¹/₂"

AE 438/18
18,0 cm/7"

AE 438/20
20,0 cm/8"

AE 438/23
23,0 cm/9"

EUFRATE PASQUÉ

extrem fein
 extremely delicate
 muy fino
 très fin
 molto fino

MICROVASCULAR

AA
 AB
 AC
 AD
AE
 AF
 AK
 AL
 AO
 KA
 KK
 X

AE NAHT SUTURE SUTURA SUTURE SUTURA

Nadelhalter mit Hartmetalleinsätzen
 Needle Holders with Tungsten Carbide Inserts
 Porta-agujas con bocas de carburo de Tungsteno
 Porte-aiguilles à mors en carbure de tungstène
 Portaghi con placche di carburo di tungsteno



CARROLL
 AE 440/15
 15,0 cm/6"

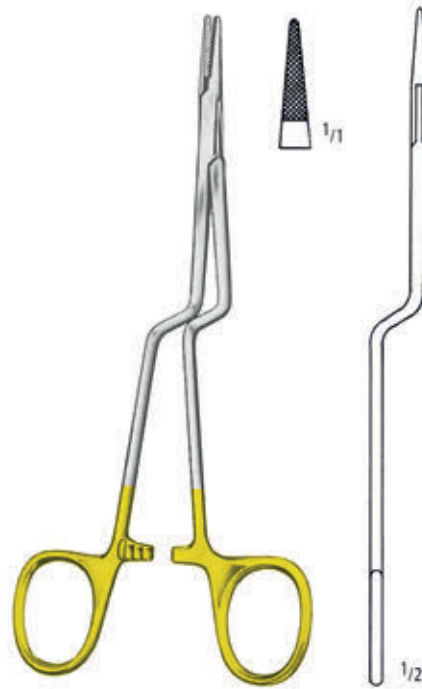

JACOBSON
 AE 444/18
 18,0 cm/7"



NEW ORLEANS
 AE 446/18
 18,0 cm/7"



SENNING
 (SWEDISH PATTERN)



AE 448/15
 15,0 cm/6"



AE 448/17
 17,0 cm/6³/₄"

NAHT SUTURE SUTURA SUTURE SUTURA

Nadelhalter mit Hartmetalleinsätzen
 Needle Holders with Tungsten Carbide Inserts
 Porta-agujas con bocas de carburo de Tungsteno
 Porte-aiguilles à mors en carbure de tungstène
 Portaghi con placche di carburo di tungsteno



DERF
 AE 450/12
 12,5 cm/5"



CONVERSE
 AE 452/12
 12,5 cm/5"



KILNER
 AE 455/13
 13,5 cm/5 1/4"



NEIVERT
 AE 456/13
 13,0 cm/5"



WEBSTER
 AE 460/13
 13,0 cm/5"



HALSEY
 13,0 cm/5"

AA
 AB
 AC
 AD
AE
 AF
 AK
 AL
 AO
 KA
 KK
 X

AE NAHT SUTURE SUTURA SUTURE SUTURA

Nadelhalter mit Hartmetalleinsätzen
 Needle Holders with Tungsten Carbide Inserts
 Porta-agujas con bocas de carburo de Tungsteno
 Porte-aiguilles à mors en carbure de tungstène
 Portaghi con placche di carburo di tungsteno



BABY-CRILE-WOOD
 AE 468/15
 15,0 cm/6"



CRILE-WOOD
 AE 469/15
 15,0 cm/6"



CRILE-WOOD
 AE 470/15
 15,0 cm/6"

nopa[®]
TUC

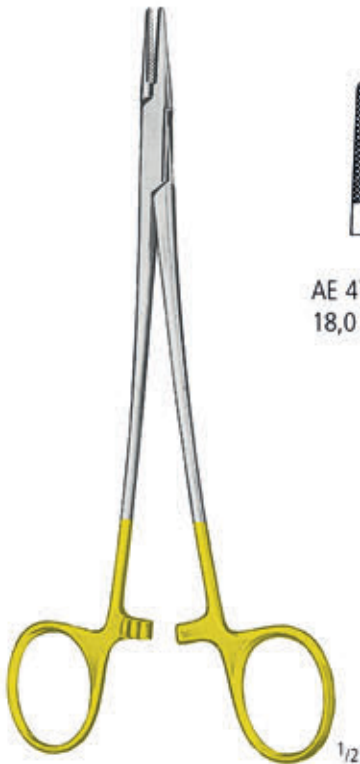

CRILE-WOOD



AE 470/18
 18,0 cm/7"



AE 470/20
 20,0 cm/8"



AE 470/23
 23,0 cm/9"



AE 471/18
 18,0 cm/7"



AE 471/23
 23,0 cm/9"

NAHT SUTURE SUTURA SUTURE SUTURA

Nadelhalter mit Hartmetalleinsätzen
 Needle Holders with Tungsten Carbide Inserts
 Porta-agujas con bocas de carburo de Tungsteno
 Porte-aiguilles à mors en carbure de tungstène
 Portaghi con placche di carburo di tungsteno



FINOCCHIETTO
 AE 472/27
 27,0 cm/10³/₄"



WANGENSTEIN
 AE 474/27
 27,0 cm/10³/₄"



BOZEMANN

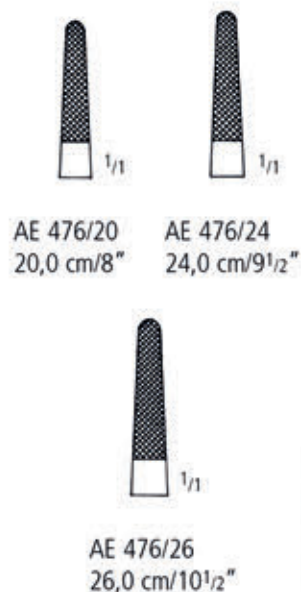

nopa®
TUC

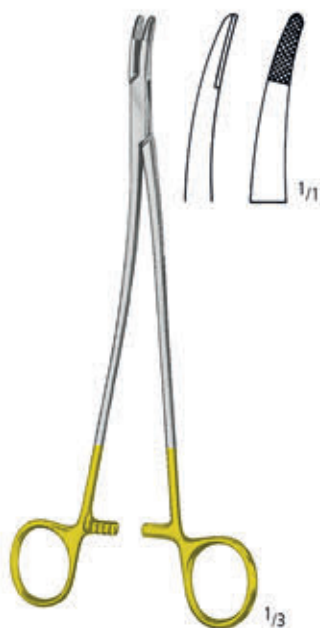

STRATTE
 AE 478/23
 23,0 cm/9"



SAROT

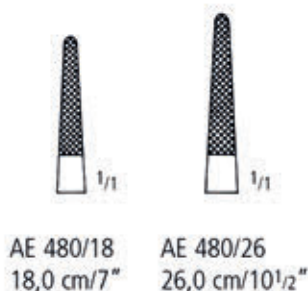

MASSON
 AE 482/27
 27,0 cm/10³/₄"

AA
 AB
 AC
 AD
AE
 AF
 AK
 AL
 AO
 KA
 KK
 X

AE NAHT SUTURE SUTURA SUTURE SUTURA

Nadelhalter mit Hartmetalleinsätzen
 Needle Holders with Tungsten Carbide Inserts
 Porta-agujas con bocas de carburo de Tungsteno
 Porte-aiguilles à mors en carbure de tungstène
 Portaghi con placche di carburo di tungsteno



WERTHEIM



AE 487/20
20,0 cm/8"



AE 487/24
24,0 cm/9 1/2"



AE 487/30
30,0 cm/12"



AE 488/14
14,0 cm/5 1/2"



AE 488/17
17,0 cm/6 3/4"



AE 488/19
19,0 cm/7 1/2"



AE 490/16
16,0 cm/6 1/4"



AE 491/16
16,0 cm/6 1/4"

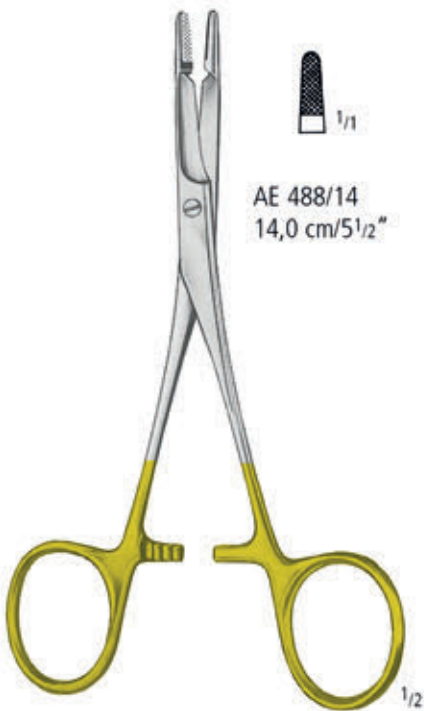

OLSEN-HEGAR

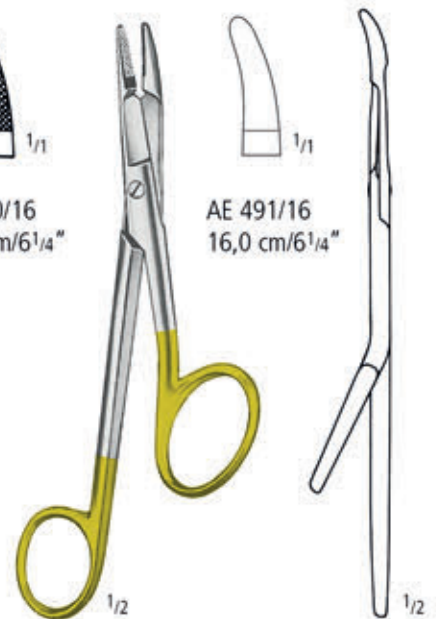





GILLIES

NAHT SUTURE SUTURA SUTURE SUTURA

Nadelhalter mit Hartmetalleinsätzen
 Needle Holders with Tungsten Carbide Inserts
 Porta-agujas con bocas de carburo de Tungsteno
 Porte-aiguilles à mors en carbure de tungstène
 Portaghi con placche di carburo di tungsteno



-  1/1
 AE 500/14
 14,0 cm/5 1/2"
-  1/1
 AE 500/17
 17,0 cm/6 3/4"
-  1/1
 AE 500/20
 20,0 cm/8"
-  1/1
 AE 500/24
 24,0 cm/9 1/2"



MATHIEU



-  1/1
 AE 501/14
 14,0 cm/5 1/2"



MATHIEU



-  1/1
 AE 502/17
 17,0 cm/6 3/4"
-  1/1
 AE 502/20
 20,0 cm/8"
-  1/1
 AE 502/23
 23,0 cm/9"

MATHIEU



-  1/1
 AE 504/14
 14,0 cm/5 1/2"
-  1/1
 AE 504/17
 17,0 cm/6 3/4"
-  1/1
 AE 504/20
 20,0 cm/8"

MATHIEU-
DELICATE



-  1/1
 AE 507/17
 17,0 cm/6 3/4"
-  1/1
 AE 507/19
 19,5 cm/7 1/2"

METZENBAUM

AA
AB
AC
AD
AE
AF
AK
AL
AO
KA
KK
X

AE NAHT SUTURE SUTURA SUTURE SUTURA

Nadelhalter mit Hartmetalleinsätzen
 Needle Holders with Tungsten Carbide Inserts
 Porta-agujas con bocas de carburo de Tungsteno
 Porte-aiguilles à mors en carbure de tungstène
 Portaghi con placche di carburo di tungsteno

nopa®
TUC



MATHIEU-RYDER



AE 510/17
 17,0 cm/6³/₄"



AE 510/20
 20,0 cm/8"



AE 510/24
 24,0 cm/9¹/₂"



MATHIEU-RYDER VASCULAR



AE 512/17
 17,0 cm/6³/₄"



AE 512/20
 20,0 cm/8"



AE 512/24
 24,0 cm/9¹/₂"

NAHT SUTURE SUTURA SUTURE SUTURA

Nadelhalter mit Hartmetalleinsätzen
 Needle Holders with Tungsten Carbide Inserts
 Porta-agujas con bocas de carburo de Tungsteno
 Porte-aiguilles à mors en carbure de tungstène
 Portaghi con placche di carburo di tungsteno

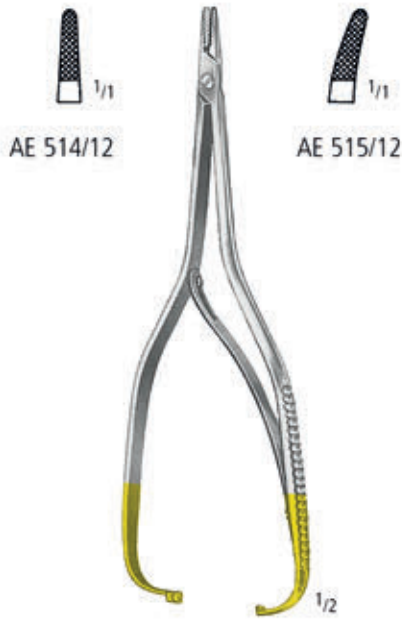

ARRUGA
16,0 cm/6¹/₄"



HÖSEL
AE 520/25
25,0 cm/10"

TOENNIS
AE 522/18
18,0 cm/7"

LICHTENBERG
AE 524/20
20,0 cm/8"

AA
AB
AC
AD
AE
AF
AK
AL
AO
KA
KK
X

AE NAHT SUTURE SUTURA SUTURE SUTURA

Nadelhalter mit Hartmetalleinsätzen
 Needle Holders with Tungsten Carbide Inserts
 Porta-agujas con bocas de carburo de Tungsteno
 Porte-aiguilles à mors en carbure de tungstène
 Portaghi con placche di carburo di tungsteno



AE 530/20
20,0 cm/8"



AE 530/23
23,0 cm/9"

nopa®
TUC

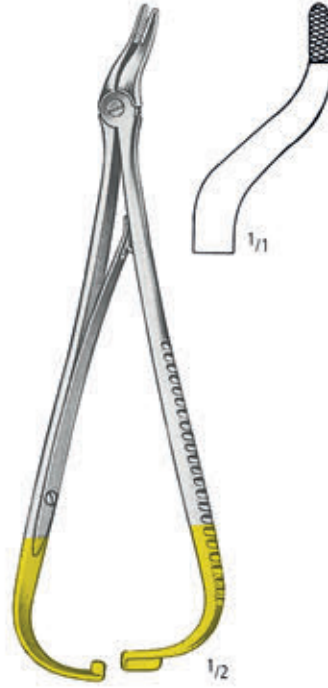

EISELSBERG-MATHIEU
 AE 533/18
 18,5 cm/7¹/₃"



LUETHY-BECK
 AE 535/20
 20,0 cm/8"

LANGENBECK

LANGENBECK-DELICATE

LANGENBECK-RYDER



AE 540/16
16,0 cm/6¹/₄"



AE 540/18
18,0 cm/7"



AE 540/20
20,0 cm/8"



AE 542/18
18,0 cm/7"



AE 542/20
20,0 cm/8"



AE 542/23
23,0 cm/9"



AE 544/18
18,0 cm/7"



AE 544/20
20,0 cm/8"



AE 544/23
23,0 cm/9"

NAHT SUTURE SUTURA SUTURE SUTURA

Drahtzangen mit Hartmetalleinsätzen
 Wire Twisting Forceps with Tungsten Carbide Inserts
 Pinzas para torcer hilos con bocas de carburo de Tungsteno
 Pincès à torsader le fil à mors en carbure de tungstène
 Pinze per ritorcere fili con placche di carburo di tungsteno



STERNUM



18,5 cm/7¼"

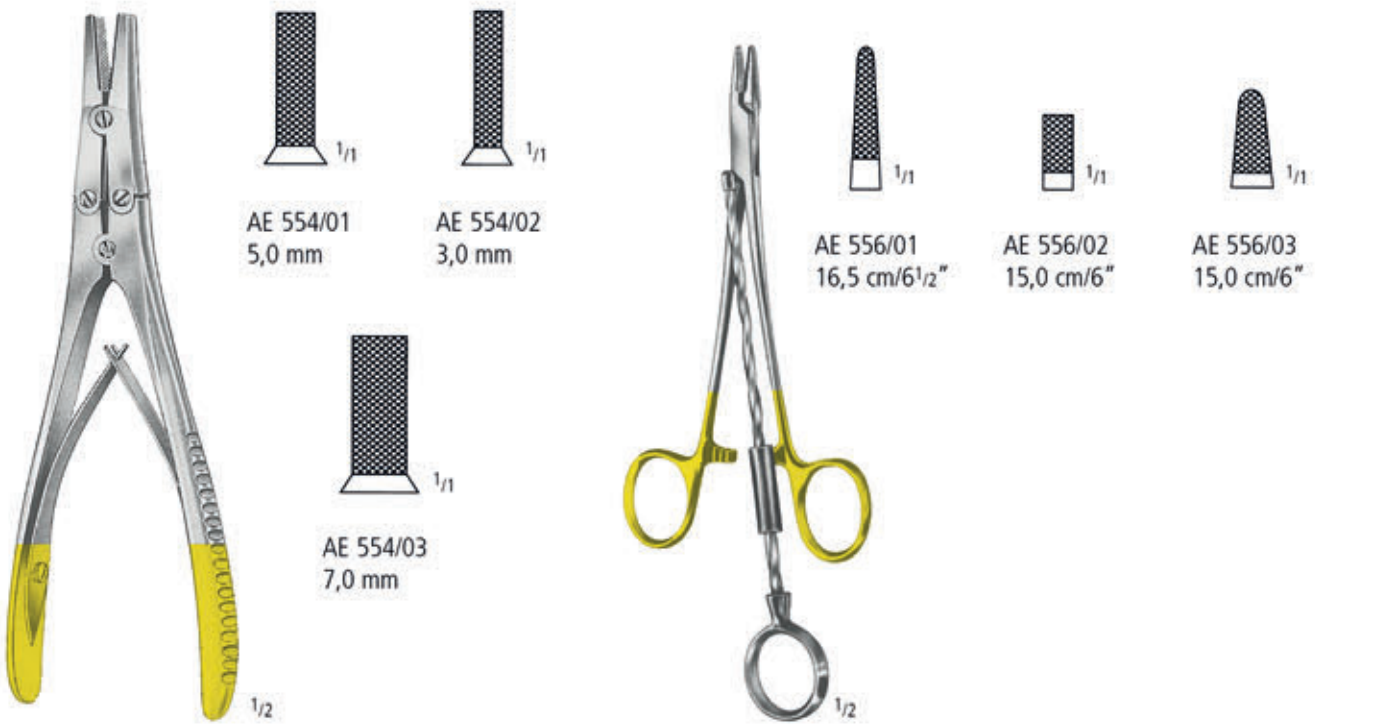

18,0 cm/7"

CORWIN

AA
AB
AC
AD
AE
AF
AK
AL
AO
KA
KK
X

AE NAHT SUTURE SUTURA SUTURE SUTURA

Mikro-Nadelhalter mit Hartmetalleinsätzen
 Micro-Needle Holders with Tungsten Carbide Inserts
 Micro-Porta-agujas con bocas de carburo de Tungsteno
 Micro-Porte-aiguilles à mors en carbure de tungstène
 Micro-Portaghi con placche di carburo di tungsteno

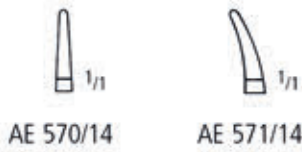

AE 570/14

AE 571/14

CASTROVIEJO
 14,0 cm/5 1/2"

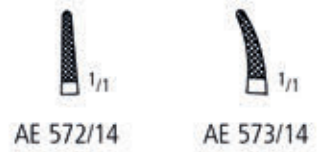

AE 572/14

AE 573/14

CASTROVIEJO
 14,0 cm/5 1/2"

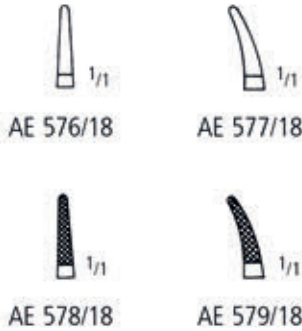

AE 576/18

AE 577/18

AE 578/18

AE 579/18

18,0 cm/7"



AE 580/01

AE 580/02

JACOBSON
 21,0 cm/8 1/4"

NAHT SUTURE SUTURA SUTURE SUTURA

Mikro-Nadelhalter mit Hartmetalleinsätzen
 Micro-Needle Holders with Tungsten Carbide Inserts
 Micro-Porta-agujas con bocas de carburo de Tungsteno
 Micro-Porte-aiguilles à mors en carbure de tungstène
 Micro-Portaghi con placche di carburo di tungsteno



DIETHRICH



AE 582/16
 16,0 cm/6 1/4"



AE 582/18
 18,0 cm/7"



AE 582/20
 20,0 cm/8"



AE 582/23
 23,0 cm/9"



AE 582/26
 26,0 cm/10 1/2"



KALT
 AE 584/14
 13,5 cm/5 1/4"



CASTROVIEJO
 AE 586/13
 13,0 cm/5"



POTTS-SMITH
 AE 588/22
 22,0 cm/8 3/4"

AA
 AB
 AC
 AD
AE
 AF
 AK
 AL
 AO
 KA
 KK
 X

Nadelhalter
Needle Holders
Porta-agujas
Porte-aiguilles
Portaghi

nopa[®] DIAMOND



14,0 cm/5 1/2"

KS 080/14



18,0 cm/7"
23,0 cm/9"

KS 080/18
KS 080/23



1/11



14,0 cm/5 1/2"

KS 081/14



18,0 cm/7"
23,0 cm/9"

KS 081/18
KS 081/23



1/11

Nadelhalter
Needle Holders
Porta-agujas
Porte-aiguilles
Portaghi

nopa® DIAMOND

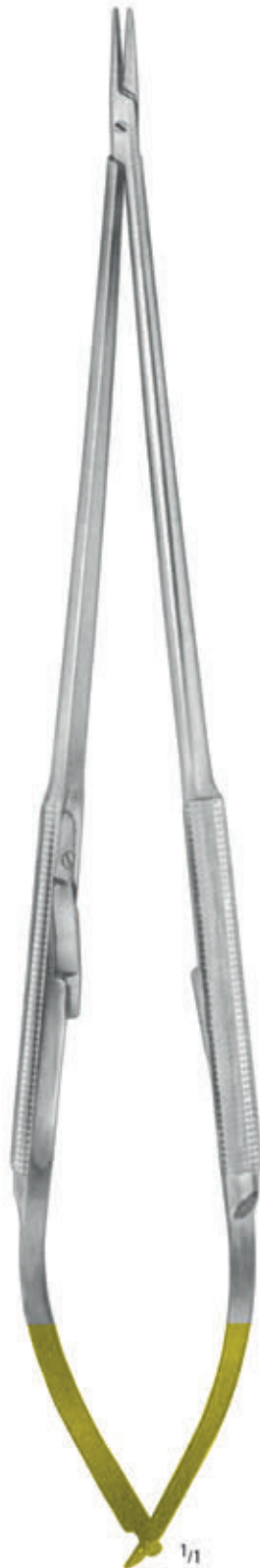

21,0 cm/8 1/4"



KS 082/21



KS 083/21

AA
AB
AC
AD
AE
AF
AK
AL
AO
KA
KK
X

AE NAHT SUTURE SUTURA SUTURE SUTURA

Mikro-Nadelhalter mit Rundgriff
 Micro-Needle Holders with Pen-Type Handle
 Micro-Porta-agujas con mango redondo
 Micro-Porte-aiguilles à manches rondes
 Micro-Portaghi con manici rotondi

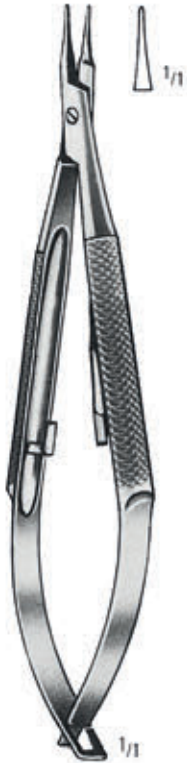

**BARRAQUER-
TROUTMAN**
 AE 600/10
 10,0 cm/4"



**BARRAQUER-
TROUTMAN**
 AE 601/10
 10,0 cm/4"



**BARRAQUER-
TROUTMAN**
 AE 602/10
 10,0 cm/4"



**BARRAQUER-
TROUTMAN**
 AE 603/10
 10,0 cm/4"



BARRAQUER
 AE 605/11
 11,0 cm/4 1/3"



BARRAQUER
 AE 605/13
 13,0 cm/5"



BARRAQUER
 AE 605/14
 14,0 cm/5 1/2"



BARRAQUER
 AE 606/14
 14,0 cm/5 1/2"



BARRAQUER
 AE 607/14
 14,0 cm/5 1/2"

NAHT SUTURE SUTURA SUTURE SUTURA

Mikro-Nadelhalter mit Rundgriff
 Micro-Needle Holders with Pen-Type Handle
 Micro-Porta-agujas con mango redondo
 Micro-Porte-aiguilles à manches rondes
 Micro-Portaghi con manici rotondi

AA

AB

AC

AD

AE

AF

AK

AL

AO

KA

KK

X



TROUTMAN
 AE 609/01
 12,0 cm/4³/₄"



TROUTMAN
 AE 609/02
 12,0 cm/4³/₄"



 1/11
 AE 610/15

 1/11
 AE 611/15



 1/11
 AE 612/15

 1/11
 AE 613/15

AE NAHT SUTURE SUTURA SUTURE SUTURA

Mikro-Nadelhalter mit Rundgriff
 Micro-Needle Holders with Pen-Type Handle
 Micro-Porta-agujas con mango redondo
 Micro-Porte-aiguilles à manches rondes
 Micro-Portaghi con manici rotondi



AE 621/14
 14,0 cm/5 1/2"



AE 623/14
 14,0 cm/5 1/2"

...für Rechtshänder
 ...for right handed surgeons
 ...para diestros
 ...pour des droitiers
 ...per destrimani

Maulteil konkav/konvex
 Jaws concave/convex
 Bocas concavas/convexas
 Mors concave/convexe
 Morso concavo/convesso



AE 625/14
 14,0 cm/5 1/2"

...für Linkshänder
 ...for left handed surgeons
 ...para zurdos
 ...pour gaucher
 ...per mancini

NAHT SUTURE SUTURA SUTURE SUTURA

Mikro-Nadelhalter mit Rundgriff
 Micro-Needle Holders with Pen-Type Handle
 Micro-Porta-agujas con mango redondo
 Micro-Porte-aiguilles à manches rondes
 Micro-Portaghi con manici rotondi



AE 630/18
 18,0 cm/7"



AE 631/18
 18,0 cm/7"



AE 632/18
 18,0 cm/7"



AE 633/18
 18,0 cm/7"

AA
 AB
 AC
 AD
AE
 AF
 AK
 AL
 AO
 KA
 KK
 X

AE NAHT SUTURE SUTURA SUTURE SUTURA

Mikro-Nadelhalter
 Micro-Needle Holders
 Micro-Porta-agujas
 Micro-Porte-aiguilles
 Micro-Portaghi

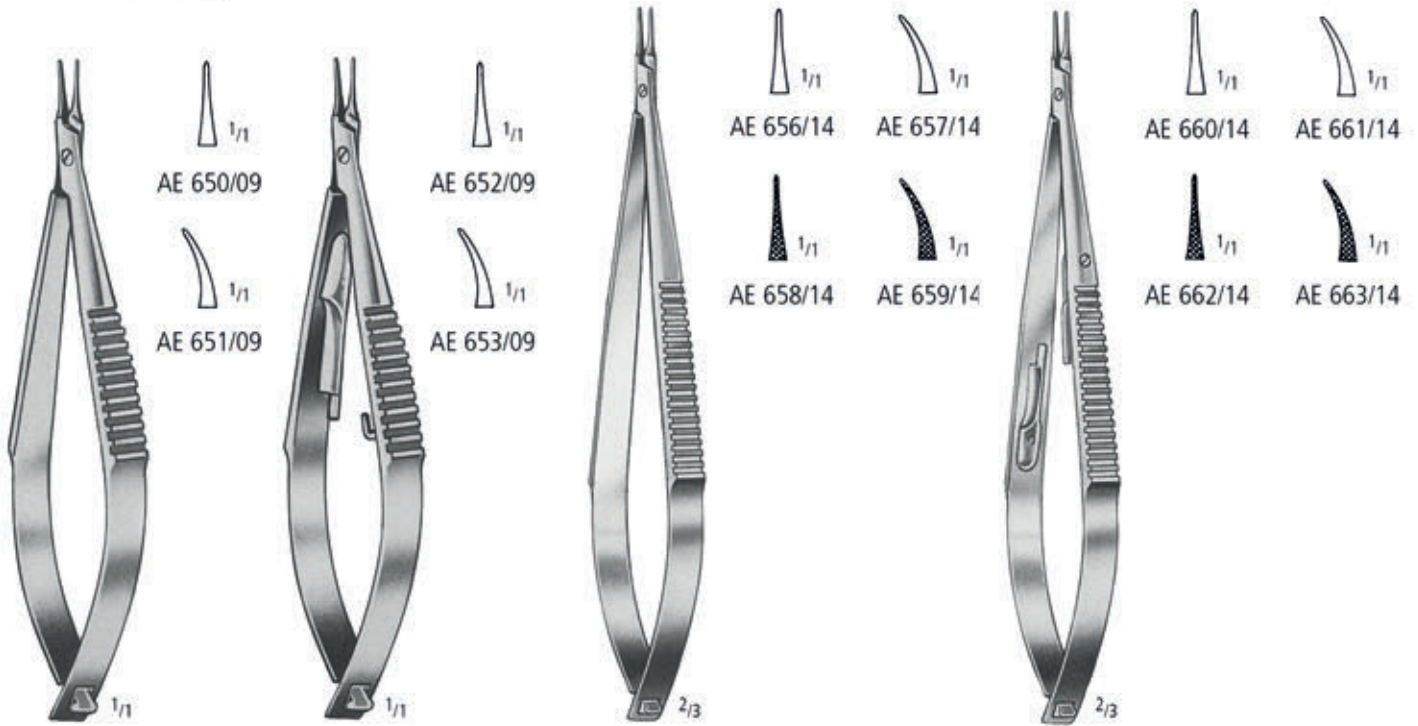

CASTROVIEJO
 9,0 cm/3¹/₂"

CASTROVIEJO
 9,0 cm/3¹/₂"

CASTROVIEJO
 14,0 cm/5¹/₂"

CASTROVIEJO
 14,0 cm/5¹/₂"

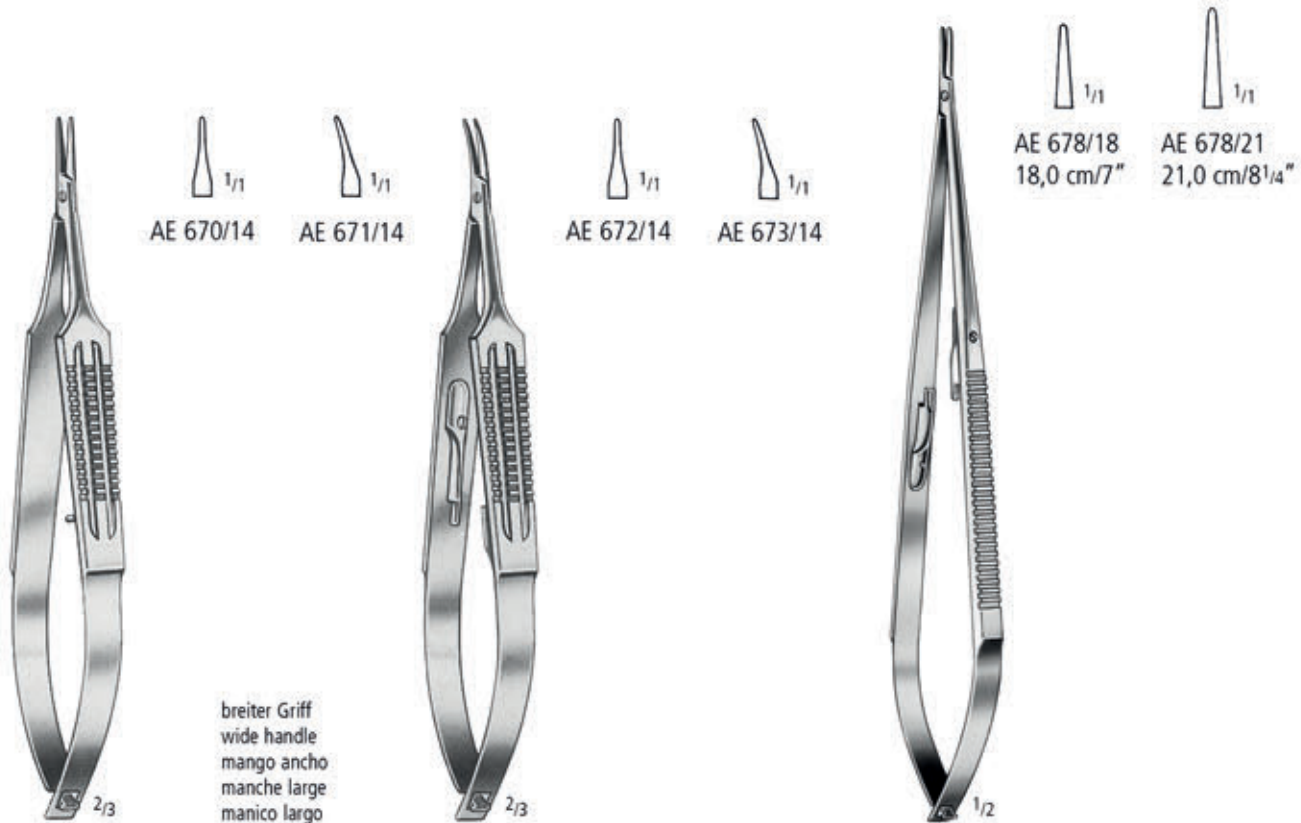

CASTROVIEJO
 14,0 cm/5¹/₂"

breiter Griff
 wide handle
 mango ancho
 manche large
 manico largo

CASTROVIEJO
 14,0 cm/5¹/₂"

JACOBSON

NAHT SUTURE SUTURA SUTURE SUTURA

Mikro-Nadelhalter
 Micro-Needle Holders
 Micro-Porta-agujas
 Micro-Porte-aiguilles
 Micro-Portaghi

AA
 AB
 AC
 AD
 AE
 AF
 AK
 AL
 AO
 KA
 KK
 X



AE 680/16
 AE 680/18
 AE 680/20
 AE 680/22

16,5 cm/6¹/₂"
 18,0 cm/7"
 20,0 cm/8"
 22,0 cm/8³/₄"



AE 681/16
 AE 681/18
 AE 681/20
 AE 681/22

TUPFERZANGEN
SPONGE FORCEPS
PINZAS PARA POLIPOS
PINCES A PANSEMENTS
PINZE PER POLIPI

AF

nopa[®] instruments

Weitere Tupferzangen finden Sie in unserem Katalog „Allgemeine Chirurgie“ in Gruppe AF.

For further sponge forceps kindly refer to our catalogue „General Surgery“, section AF.

Para pinzas polipos adicionales, por favor consulte nuestro catálogo de „Cirugía general“, grupo AF.

Pour des pinces à pansements supplémentaires, consultez notre catalogue „Chirurgie Generale“, section AF.

Per gli altri pinze per polipi, consultare il nostro catalogo „Chirurgia Generale“, gruppo AF.



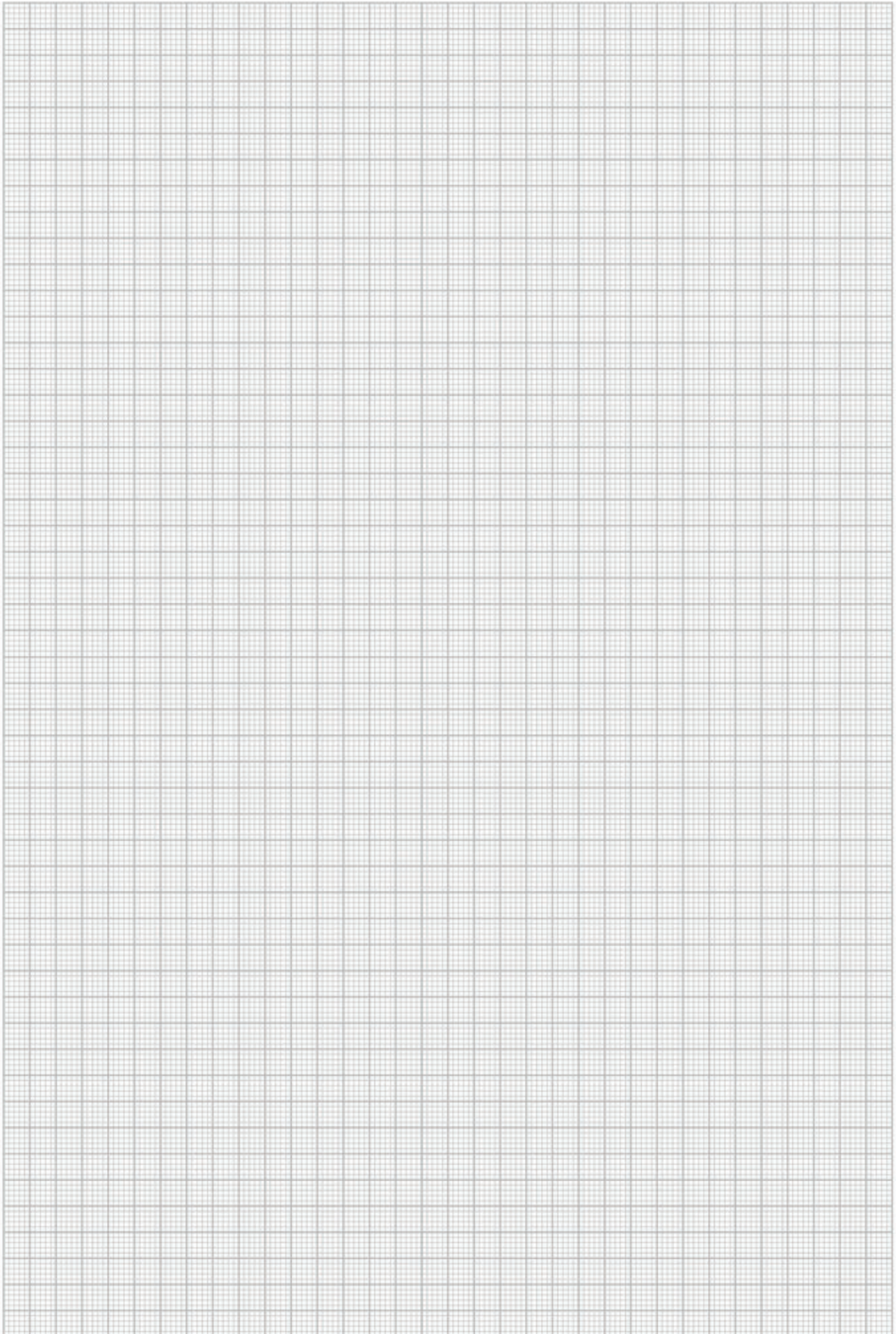

Korn- und Tupferzangen, Schwammzangen
 Polypus and Dressing Forceps, Sponge Holding Forceps
 Pinzas para pólipos, tapones y esponjas
 Pincas à pansements, à tampons et à éponges
 Pinze per polipi, tamponi e spugne

AA
 AB
 AC
 AD
 AE
 AF
 AK
 AL
 AO
 KA
 KK
 X

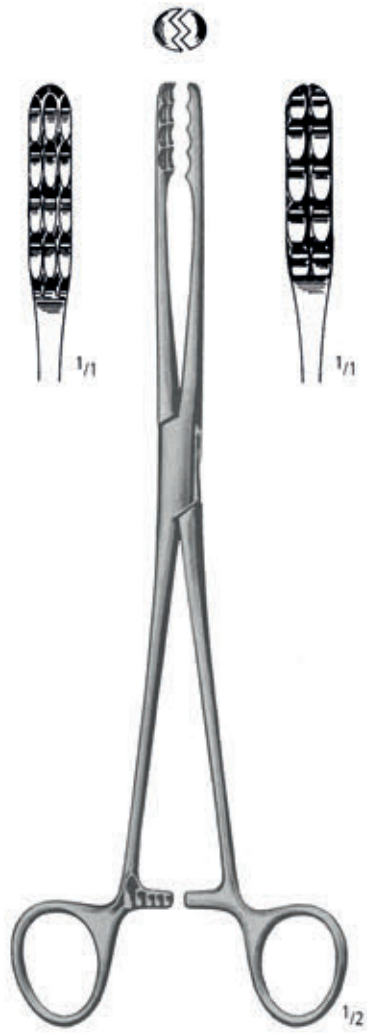

ULRICH
 AF 070/22
 AF 070/25

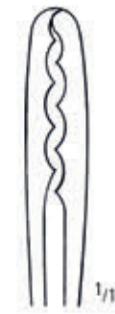

22,0 cm/8³/₄"
 25,0 cm/10"

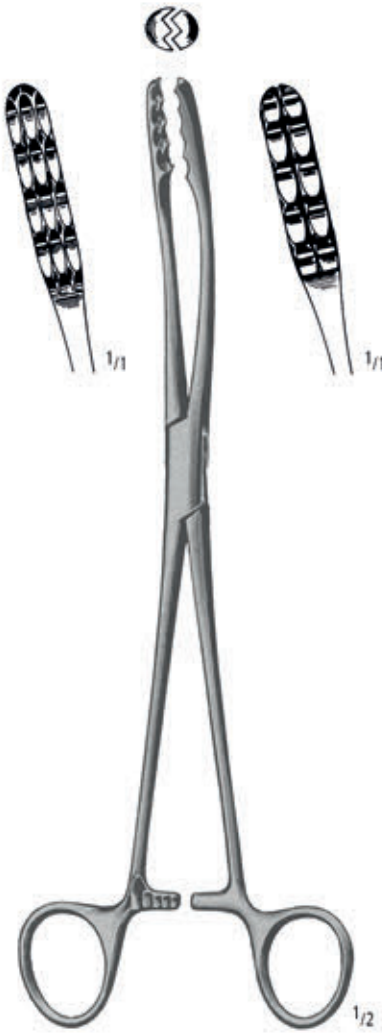

ULRICH
 AF 071/22
 AF 071/25

Korn- und Tupferzangen, Schwammzangen
 Polypus and Dressing Forceps, Sponge Holding Forceps
 Pinzas para pólipos, tapones y esponjas
 Pincers à pansements, à tampons et à éponges
 Pinze per polipi, tamponi e spugne



GROSS-MAIER

- AF 100/20
- AF 100/22
- AF 100/25
- AF 100/27

- 20,0 cm/8"
- 22,0 cm/8³/₄"
- 25,0 cm/10"
- 27,0 cm/10³/₄"



GROSS-MAIER

- AF 101/20
- AF 101/22
- AF 101/25
- AF 101/27

Korn- und Tupferzangen, Schwammzangen
 Polypus and Dressing Forceps, Sponge Holding Forceps
 Pinzas para pólipos, tapones y esponjas
 Pincas à pansements, à tampons et à éponges
 Pinze per polipi, tamponi e spugne

AA
 AB
 AC
 AD
 AE
 AF
 AK
 AL
 AO
 KA
 KK
 X



GROSS-MAIER

- AF 102/20
- AF 102/22
- AF 102/25
- AF 102/27

- 20,0 cm/8"
- 22,0 cm/8³/₄"
- 25,0 cm/10"
- 27,0 cm/10³/₄"



GROSS-MAIER

- AF 103/20
- AF 103/22
- AF 103/25
- AF 103/27

Korn- und Tupferzangen, Schwammzangen
 Polypus and Dressing Forceps, Sponge Holding Forceps
 Pinzas para pólipos, tapones y esponjas
 Pincès à pansements, à tampons et à éponges
 Pinze per polipi, tamponi e spugne



FOERSTER-BALLENGER



AF 200/18
 AF 200/20



AF 201/18
 AF 201/20

18,0 cm/7"
 20,0 cm/8"



AF 202/18
 AF 202/20



AF 203/18
 AF 203/20



FOERSTER-BALLENGER

25,0 cm/10"



AF 200/25



AF 201/25



AF 202/25



AF 203/25

Korn- und Tupferzangen, Schwammzangen
 Polypus and Dressing Forceps, Sponge Holding Forceps
 Pinzas para pólipos, tapones y esponjas
 Pincas à pansements, à tampons et à éponges
 Pinze per polipi, tamponi e spugne

AA

AB

AC

AD

AE

AF

AK

AL

AO

KA

KK

X

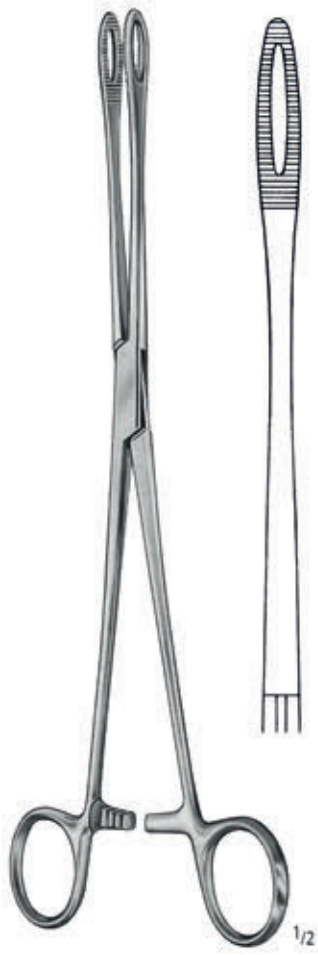

25,0 cm/10"

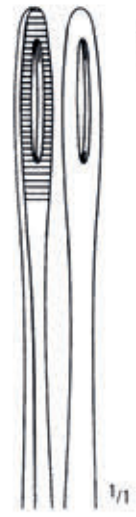

AF 210/25



AF 211/25

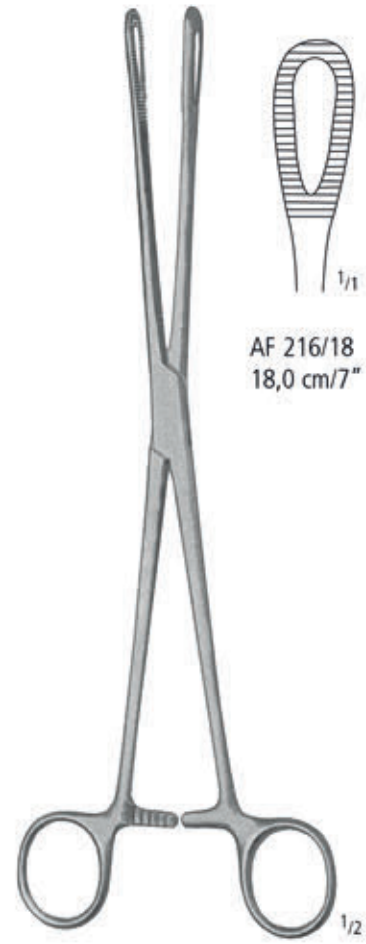

RAMPLEY



AF 216/18
18,0 cm/7"



AF 216/25
25,0 cm/10"

WUNDHAKEN
RETRACTORS
SEPARADORES
ECARTEURS
DIVARICATORI

AK

nopa[®] instruments

Weitere Wundhaken finden Sie in unserem Katalog „Allgemeine Chirurgie“ in Gruppe AK.

For further retractors kindly refer to our catalogue „General Surgery“, section AK.

Para más separadores, por favor consulte nuestro catálogo de „Cirugía general“, grupo AK.

Pour plusd' ecarteurs, consultez notre catalogue „Chirurgie Generale“, section AK.

Per gli altri divaricatori, consultare il nostro catalogo „Chirurgia Generale“, gruppo AK.



Feine Wundhaken
Delicate Hooks
Ganchos
Crochets très fins
Divaricatori sottili



CUSHING
28,0 cm/11"



AK 034/01



AK 034/02



CUSHING
19,0 cm/7¹/₂"



AK 036/01



AK 036/02



MOLDESTAD
AK 038/13
13,0 cm/5"



AK 040/05
5 mm



AK 040/07
7 mm

17,0 cm/6³/₄"



18,5 cm/7¹/₃"



AK 042/10
Ø 1,0 mm



AK 042/12
Ø 1,2 mm

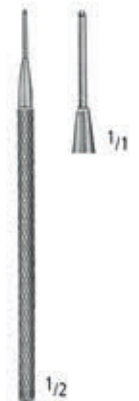

AK 044/11
11,0 cm/4¹/₃"

WUNDHAKEN RETRACTORS SEPARADORES ECARTEURS DIVARICATORI

Feine Wundhaken
Delicate Hooks
Ganchos
Crochets très fins
Divaricatori sottili

AA
AB
AC
AD
AE
AF
AK
AL
AO
KA
KK
X



MEYERDING
18,0 cm/7"



AK 080/01
18 x 7 mm



AK 080/03
7 x 4 mm



AK 080/05
7 x 4 mm



AK 080/02
16 x 5 mm



AK 080/04
10 x 3 mm



AK 080/06
4 x 10 mm



SENN-GREEN
15,0 cm/6"



AK 082/10
10 x 6 mm



AK 082/20
22 x 8 mm



MINI-LANGENBECK
16,0 cm/6 1/4"



AK 086/10
10 x 6 mm



AK 086/17
17 x 5 mm



AK 086/20
20 x 6 mm



AK 086/22
22 x 8 mm

AK WUNDHAKEN RETRACTORS SEPARADORES ECARTEURS DIVARICATORI

Feine Wundhaken
Delicate Hooks
Ganchos
Crochets très fins
Divaricatori sottili

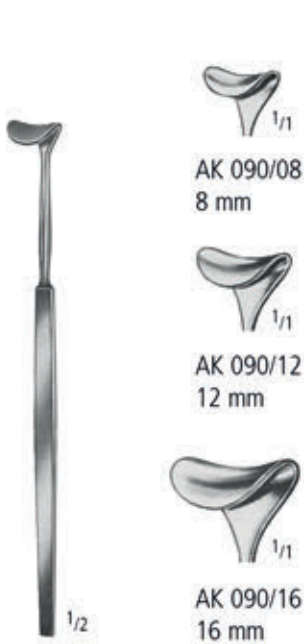

DESMARRES
13,0 cm/5"



DESMARRES
16,0 cm/6 1/4"

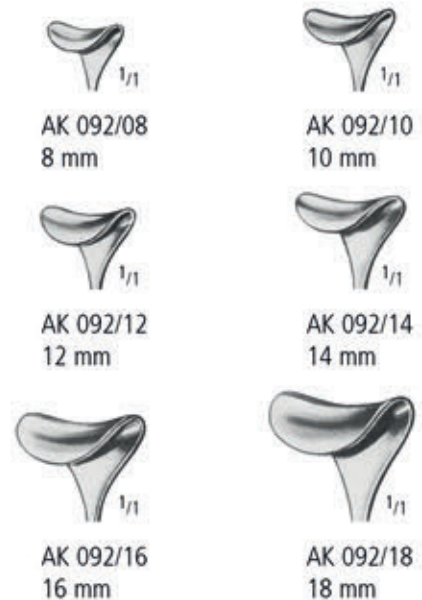

CUSHING
20,0 cm/8"



CUSHING
24,0 cm/9 1/2"

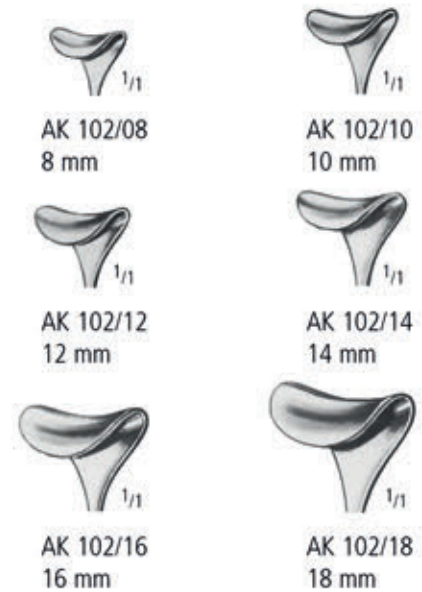

WUNDHAKEN RETRACTORS SEPARADORES ECARTEURS DIVARICATORI

Feine Wundhaken
Delicate Hooks
Ganchos
Crochets très fins
Divaricatori sottili

AA
AB
AC
AD
AE
AF
AK
AL
AO
KA
KK
X

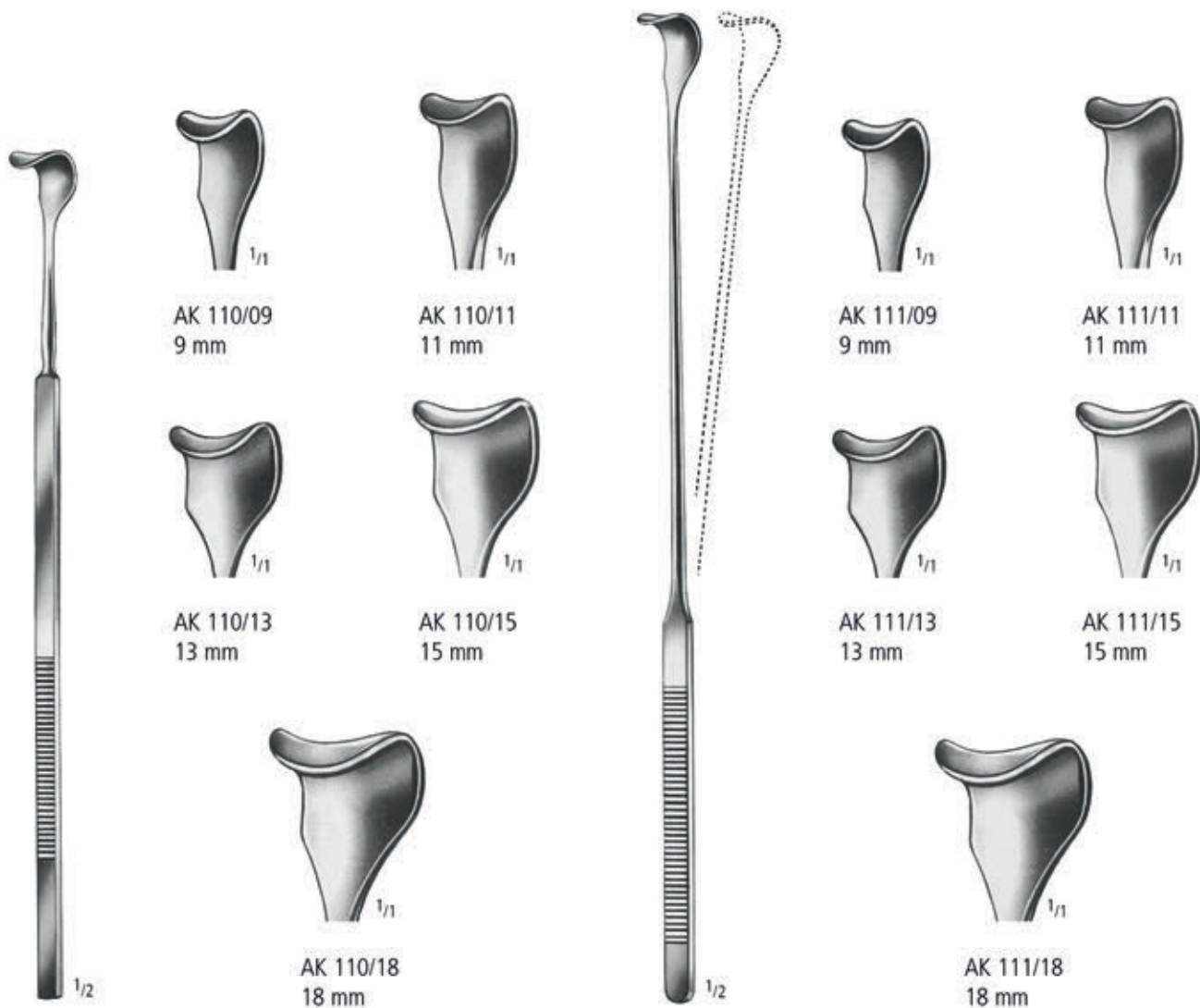

GIL-VERNET
24,5 cm/9³/₄''

GIL-VERNET
28,0 cm/11''

AK WUNDHAKEN RETRACTORS SEPARADORES ECARTEURS DIVARICATORI

Feine Wundhaken, Spinalhaken
 Delicate Retractors, Spinal Retractors
 Separadores finas, Separadores espinales
 Ecarteurs fins, Ecarteurs spinals
 Divaricatori sottili, Divaricatori spinali



BABY-SENN-MILLER
 15,0 cm/6"



AK 120/15



AK 121/15



SENN-MILLER
 16,0 cm/6 1/4"



AK 122/16



AK 123/16



RAGNELL-DAVIS
 AK 125/14
 14,0 cm/5 1/2"



CUSHING
 AK 130/20
 20,0 cm/8"



TAYLOR
 16,5 cm/6 1/2"

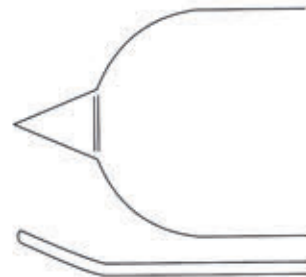

AK 132/07
 75 x 30 mm

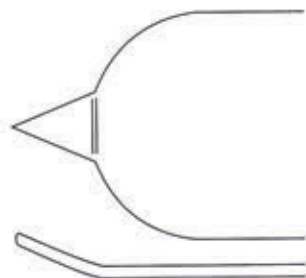

AK 132/10
 100 x 30 mm



VOLKMANN
21,5 cm/8¹/₂"



KOCHER
22,0 cm/8³/₄"

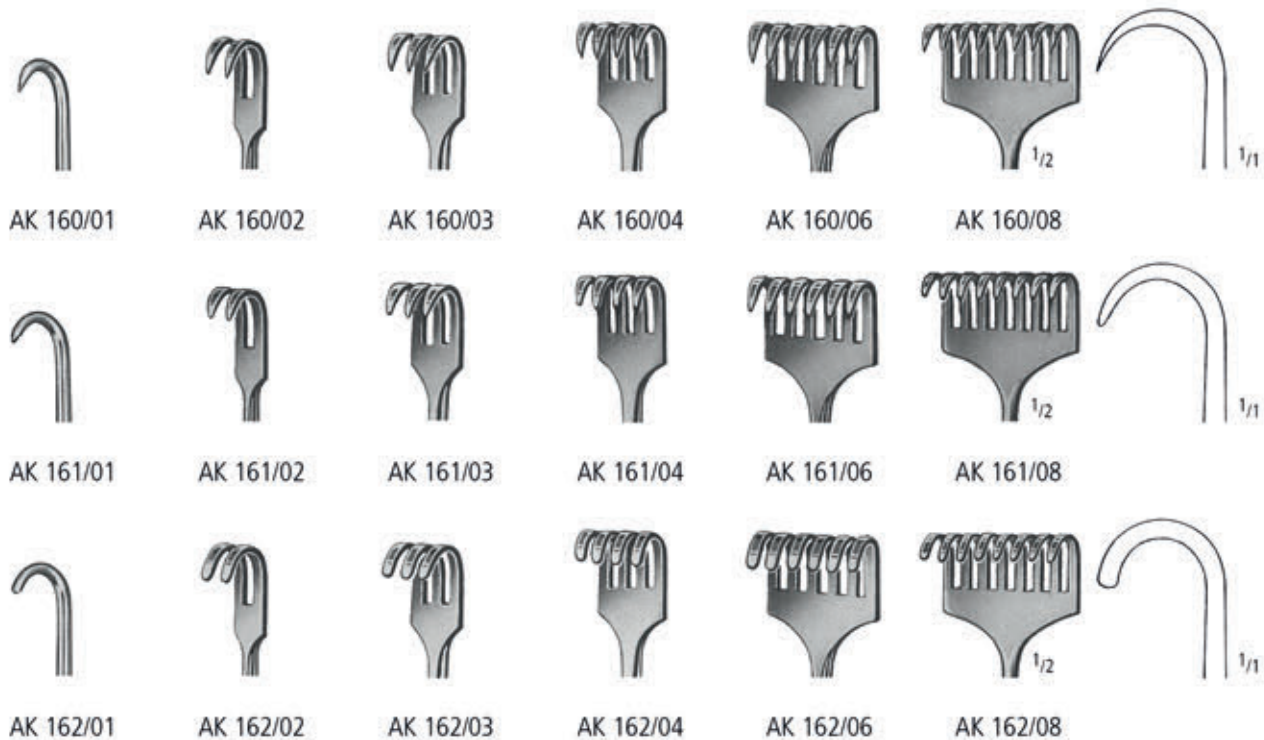



AK 170/21



AK 171/21

VOLKMANN
21,5 cm/8 1/2"



AK 172/20
20,0 cm/8"



AK 173/20
20,0 cm/8"



AK 180/08
26 x 40 mm



AK 181/08
26 x 40 mm

KOERTE
24,0 cm/9 1/2"



AK 185/35
35 x 40 mm



AK 185/43
43 x 35 mm



AK 185/45
45 x 50 mm

BILLROTH
25,0 cm/10"



AK 200/30
36 x 30 mm



AK 200/60
36 x 60 mm

OLLIER
22,5 cm/9"



ISRAEL
25,0 cm/10"



AK 210/40
40 x 40 mm

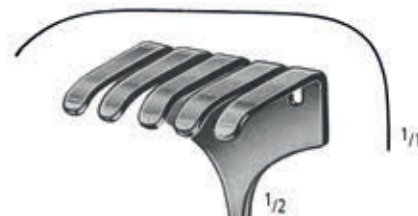

AK 210/50
45 x 50 mm

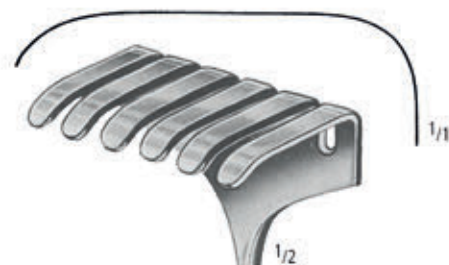

AK 210/60
50 x 60 mm

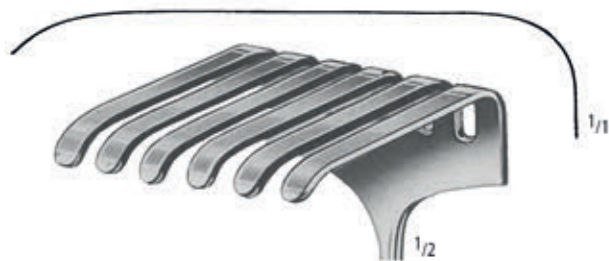

AK 210/70
70 x 70 mm



LANGENBECK
21,0 cm/8¹/₄"

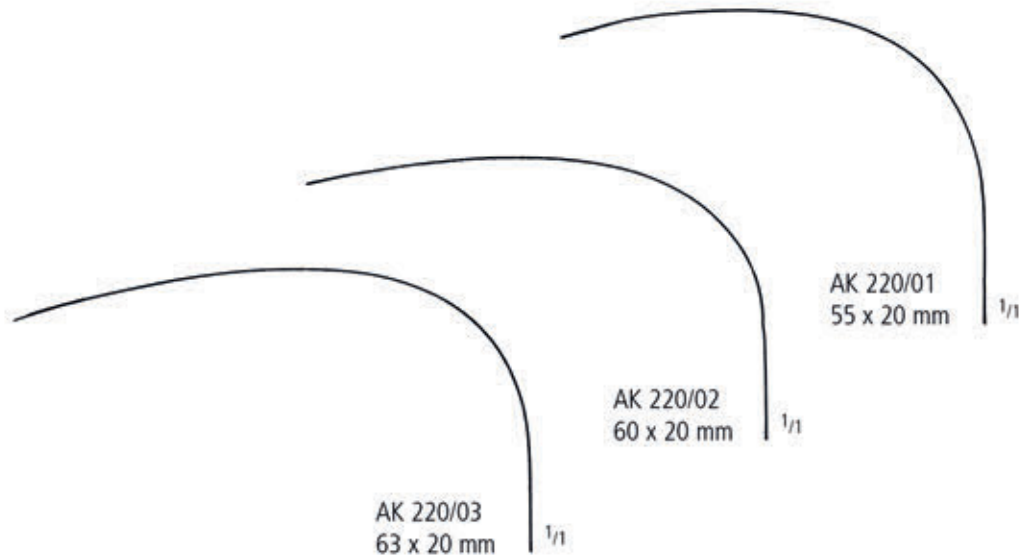

AK 220/01
55 x 20 mm ¹/₁

AK 220/02
60 x 20 mm ¹/₁

AK 220/03
63 x 20 mm ¹/₁



LANGENBECK
AK 230/01-05
22,0 cm/8³/₄"



AK 230/01
AK 231/01
30 x 11 mm



AK 230/02
AK 231/02
30 x 14 mm



AK 230/03
AK 231/03
30 x 16 mm



AK 230/04
AK 231/04
40 x 11 mm



AK 230/05
AK 231/05
50 x 11 mm



LANGENBECK
AK 231/01-05
22,0 cm/8³/₄"



KOCHER-LANGENBECK
21,5 cm/8½"



AK 233/01
25 x 6 mm



AK 233/02
35 x 8 mm



AK 233/03
35 x 11 mm



AK 233/04
35 x 15 mm



AK 233/05
40 x 11 mm



AK 233/06
55 x 11 mm



AK 233/07
70 x 14 mm



AK 233/08
80 x 12 mm



AK 233/09
80 x 16 mm



KOCHER
23,0 cm/9"

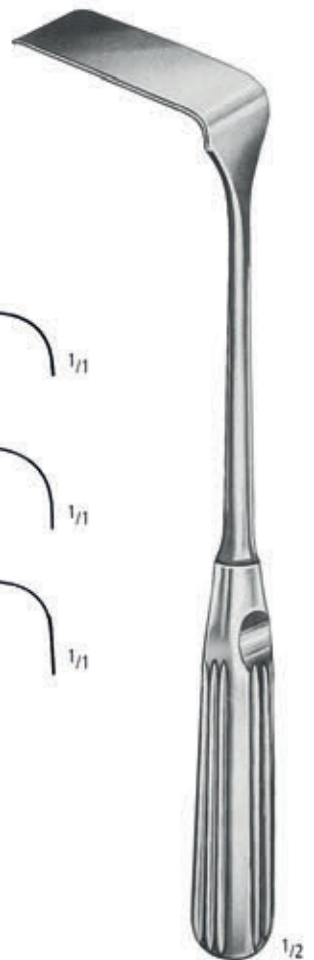
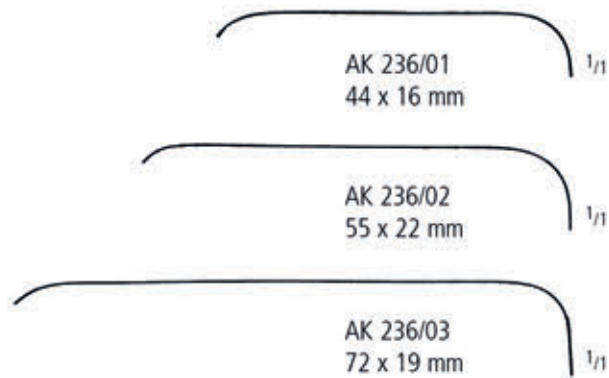
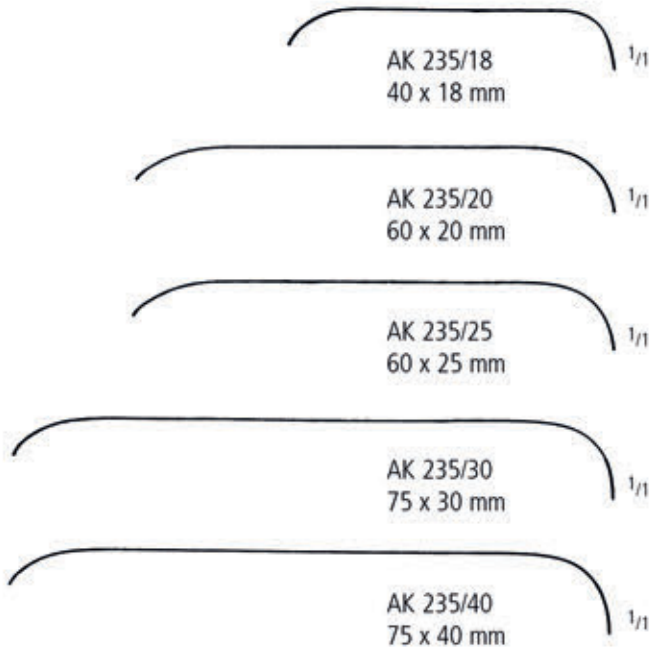

SAUERBRUCH
22,5 cm/8³/₄"



AK 237/01
50 x 55 mm

MORRIS
26,0 cm/10¹/₂"

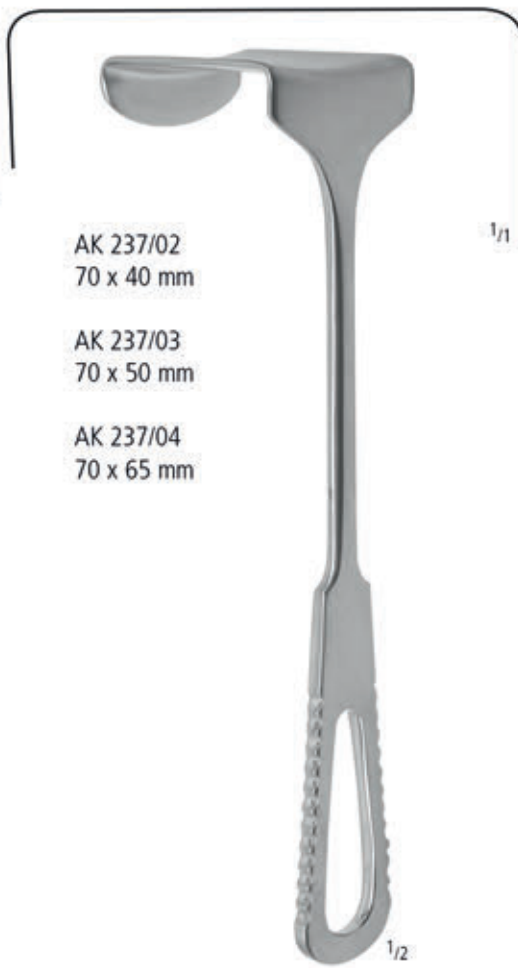

AK 237/02
70 x 40 mm

AK 237/03
70 x 50 mm

AK 237/04
70 x 65 mm

MORRIS
25 cm/10"



60 x 50 mm

60 x 45 mm

MORRIS
AK 238/24
25,0 cm/10"

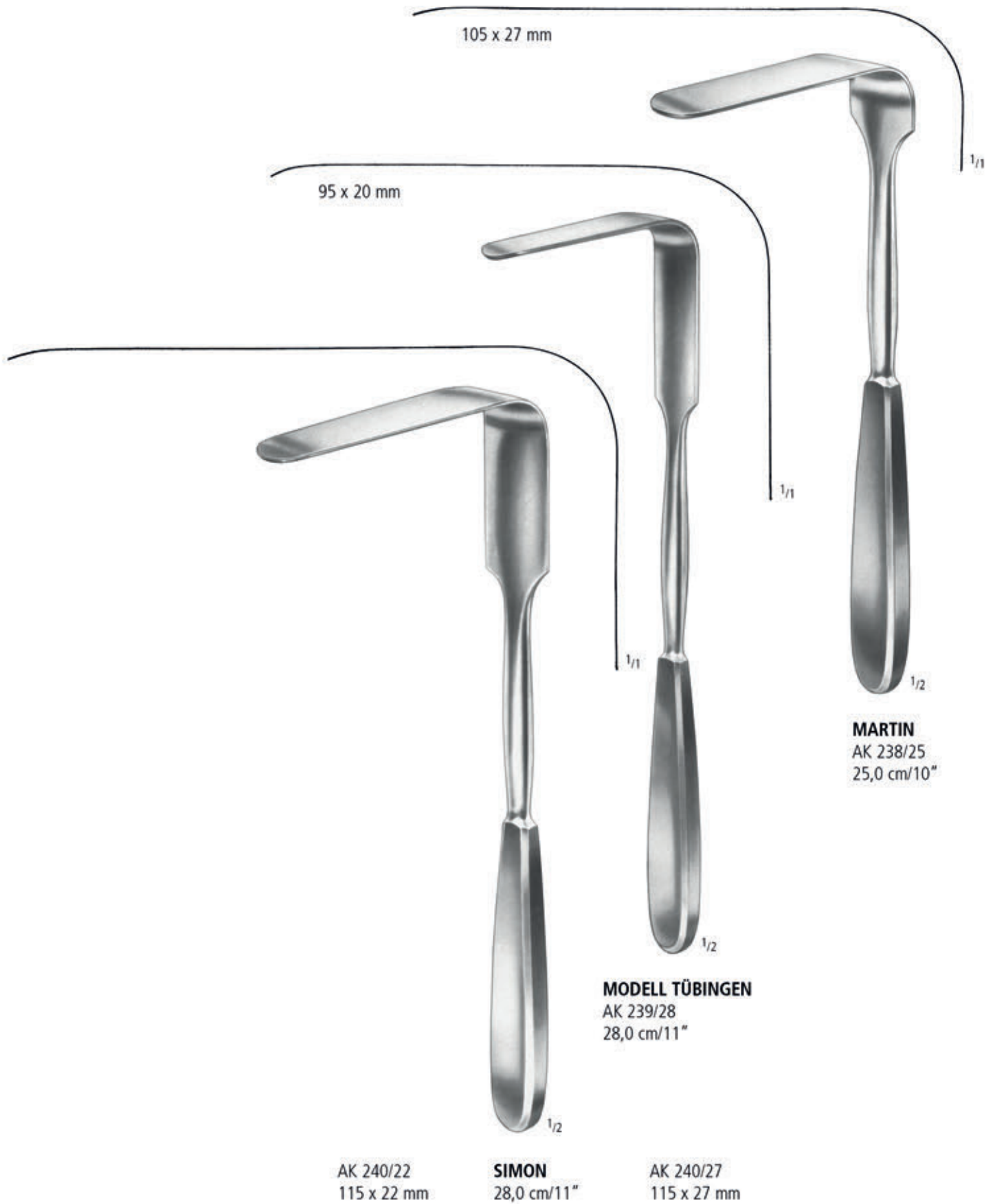

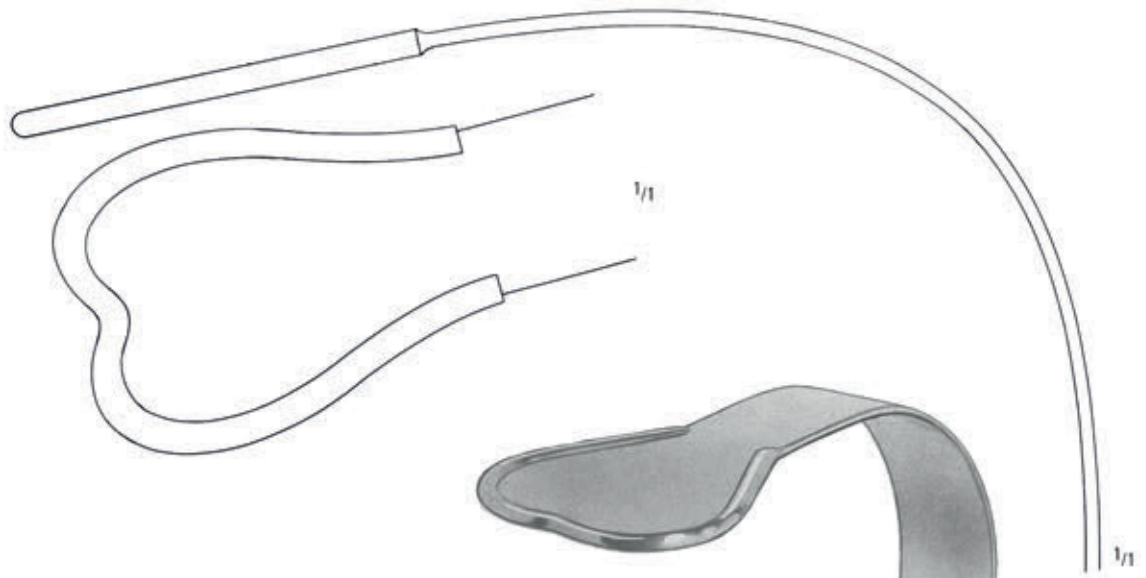

50 x 85 mm

DOYEN
AK 280/25
25,0 cm/10"



64 x 60 mm

TUFFIER
AK 282/23
23,0 cm/9"

HARRINGTON
32,0 cm/12³/₄"
127 x 40 mm AK 284/40
127 x 62 mm AK 284/62
175 x 64 mm AK 284/64

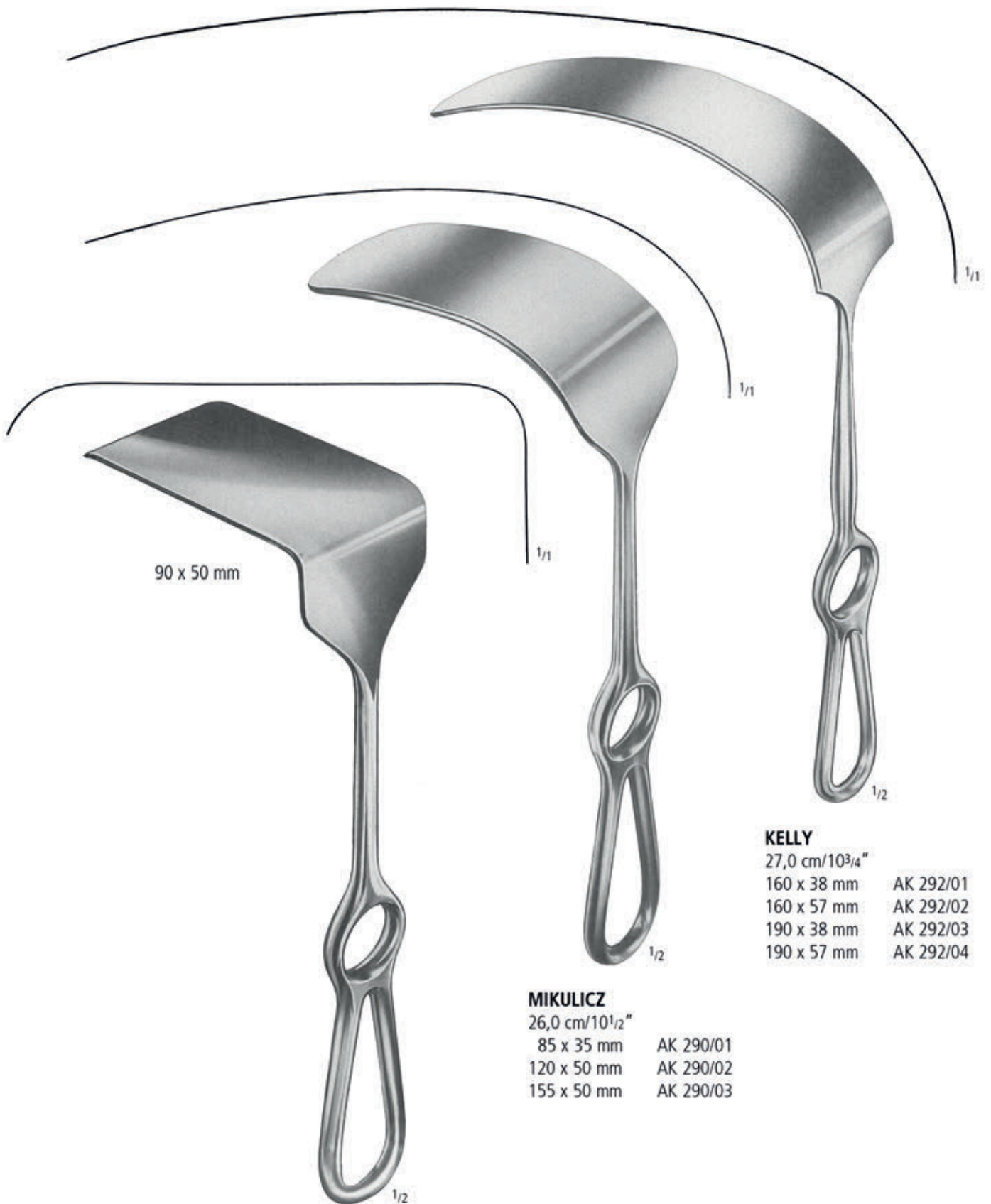

90 x 50 mm

MIKULICZ
AK 286/26
26,0 cm/10¹/₂"

MIKULICZ
26,0 cm/10¹/₂"
85 x 35 mm AK 290/01
120 x 50 mm AK 290/02
155 x 50 mm AK 290/03

KELLY
27,0 cm/10³/₄"
160 x 38 mm AK 292/01
160 x 57 mm AK 292/02
190 x 38 mm AK 292/03
190 x 57 mm AK 292/04



DEAVER
AK 300/01
18,0 cm/7"

DEAVER
AK 300/02
21,5 cm/8½"

DEAVER
AK 300/03
23,0 cm/9"

DEAVER
AK 300/04
30,0 cm/12"

DEAVER
AK 300/05
33,0 cm/13"

DEAVER
AK 300/06
36,0 cm/14"



38 mm

DEAVER
AK 300/07
30,0 cm/12"



50 mm

DEAVER
AK 300/08
30,0 cm/12"



75 mm

DEAVER
AK 300/09
30,0 cm/12"

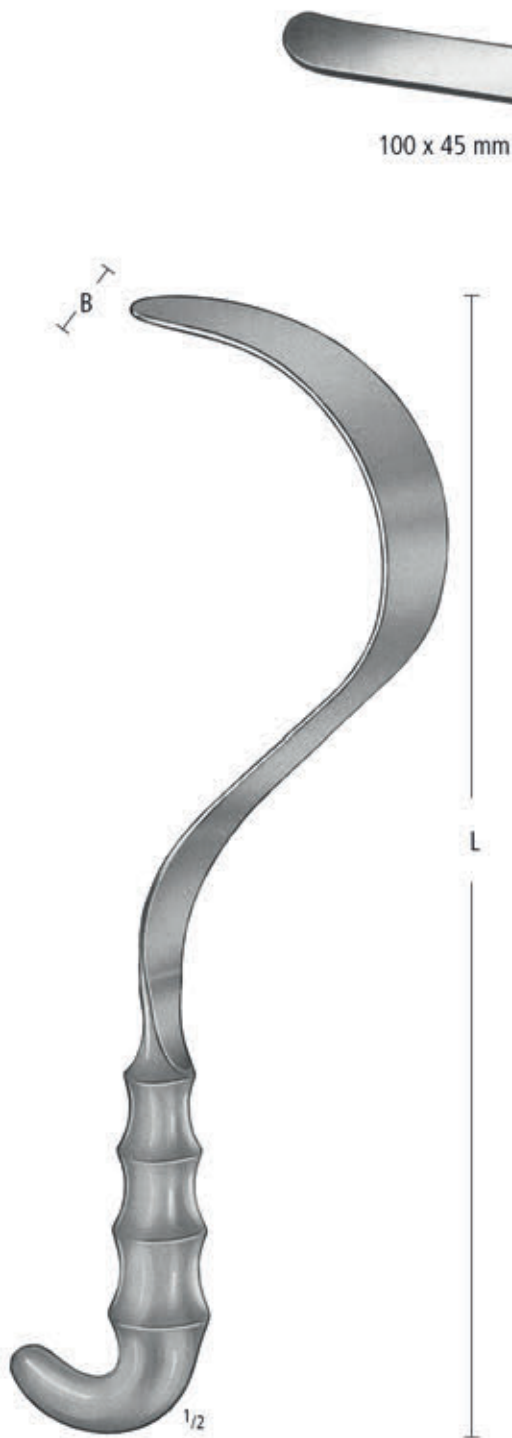

DEAVER
AK 310/01-05

	B	L	
Fig. 1	25 mm	30,5 cm/12"	AK 310/01
Fig. 2	25 mm	33,0 cm/13"	AK 310/02
Fig. 3	38 mm	30,5 cm/12"	AK 310/03
Fig. 4	50 mm	30,5 cm/12"	AK 310/04
Fig. 5	75 mm	30,5 cm/12"	AK 310/05



KOERTE
AK 312/28
28,0 cm / 11"

fest
rigid
rigida
rigide
rigide

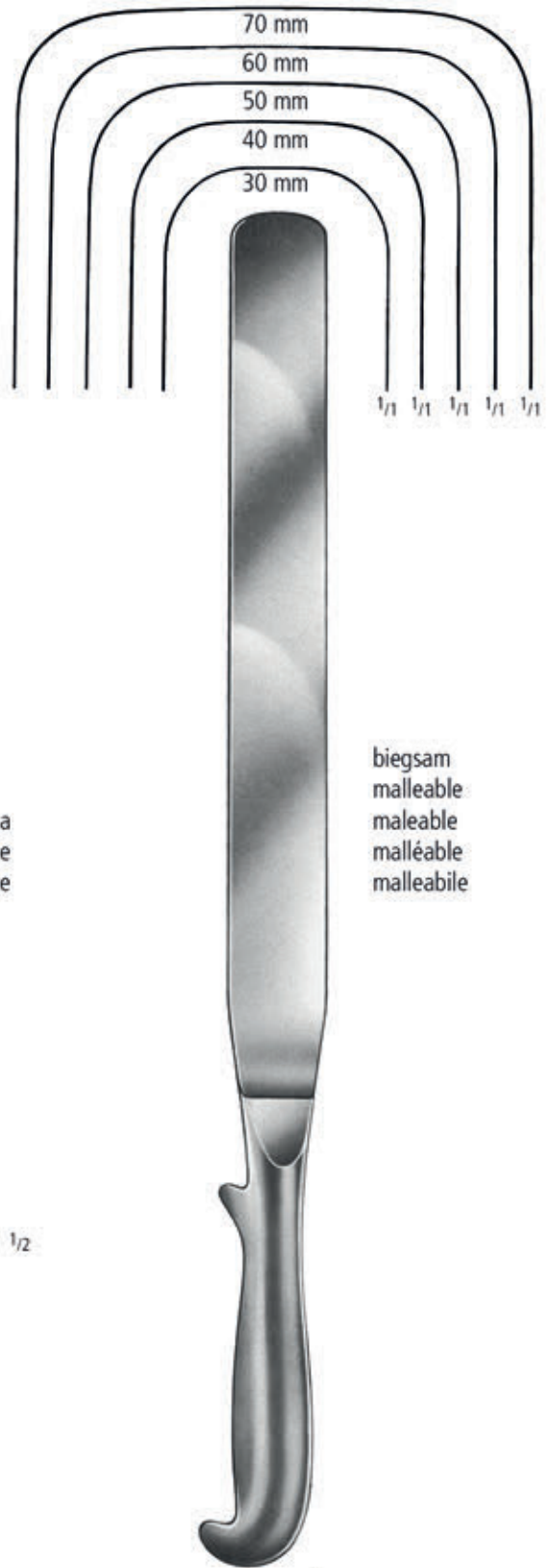

41,0 cm / 16"

245 x 30 mm	AK 315/30
245 x 40 mm	AK 315/40
245 x 50 mm	AK 315/50
245 x 60 mm	AK 315/60
245 x 70 mm	AK 315/70

biegsam
malleable
maleable
malléable
malleabile

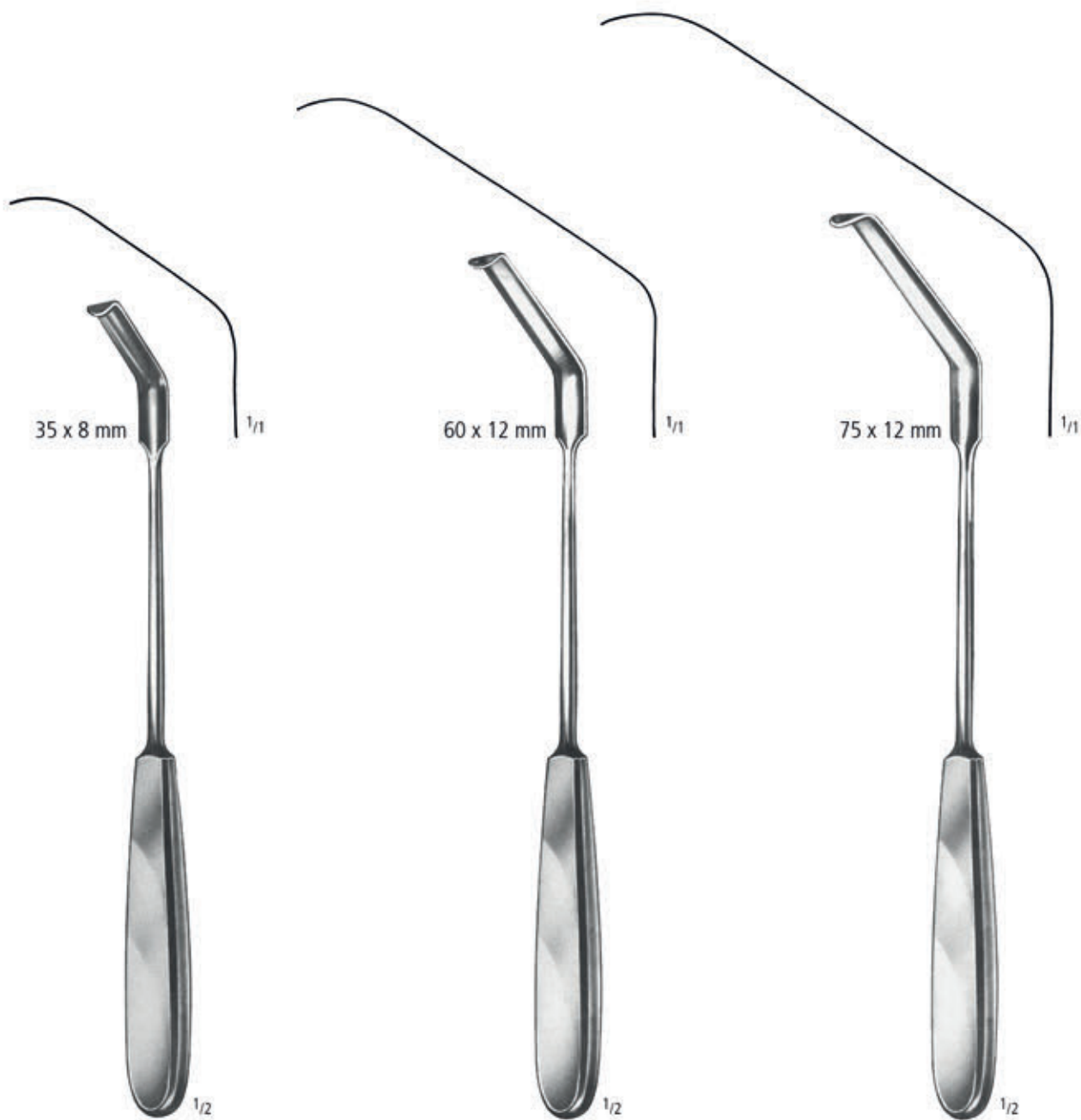

35 x 8 mm

1/1

60 x 12 mm

1/1

75 x 12 mm

1/1

1/2

1/2

1/2

ZENKER
AK 318/35
25,0 cm/10"

ZENKER
AK 318/60
26,0 cm/10¹/₂"

ZENKER
AK 318/75
27,5 cm/10³/₄"

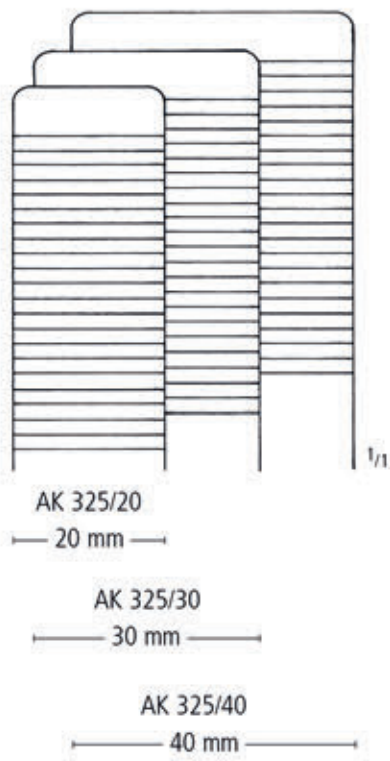

KADER
27,0 cm/10³/₄"



CORYLLOS
24,0 cm/9 1/2"



SAUERBRUCH
AK 330/25
25,0 cm/10"



75 x 50 mm

DAVIDSON
AK 337/50
16,0 cm/6¹/₄"



75 x 90 mm

DAVIDSON
AK 337/90
16,0 cm/6¹/₄"

AK WUNDHAKEN RETRACTORS SEPARADORES ECARTEURS DIVARICATORI

Selbsthaltende Wundsperrer
 Selfretaining Retractors
 Separadores autoestaticos
 Ecarteurs autostatiques
 Divaricatori autostatici



FINSEN

	^	
5,0 cm/2"	AK 500/05	AK 501/05
7,0 cm/2¾"	AK 500/07	AK 501/07



	^	^
AK 502/10	AK 503/10	
	10,0 cm/4"	



ALM

	^	^
7,0 cm/2¾"	AK 506/07	AK 507/07
10,0 cm/4"	AK 506/10	AK 507/10



JANSEN

	^	^
AK 510/10	AK 511/10	
	10,0 cm/4"	



JANSEN

	^	^
AK 512/10	AK 513/10	
	10,0 cm/4"	



SNITMAN

	^	^
AK 514/10	AK 515/10	
	10,5 cm/4¼"	

Selbsthaltende Wundsperrer
Selfretaining Retractors
Separadores autoestaticos
Ecarteurs autostatiques
Divaricatori autostatici

AA
AB
AC
AD
AE
AF
AK
AL
AO
KA
KK
X

WEITLANER



WEITLANER-BABY
AK 519/14
14,0 cm/5 1/2"



WEITLANER
AK 520/13 AK 521/13
13,0 cm/5"



WEITLANER

10,5 cm/4 1/4"	2 x 3
13,0 cm/5"	3 x 4
16,5 cm/6 1/2"	3 x 4
20,0 cm/8"	3 x 4
25,0 cm/10"	3 x 4
26,0 cm/10 1/2"	5 x 6

^
AK 522/10
AK 524/13
AK 526/16
AK 528/20
AK 530/25
AK 532/26

∩
AK 523/10
AK 525/13
AK 527/16
AK 529/20
AK 531/25
AK 533/26

AK WUNDHAKEN RETRACTORS SEPARADORES ECARTEURS DIVARICATORI

Selbsthaltende Wundsperrer
 Selfretaining Retractors
 Separadores autoestaticos
 Ecarteurs autostatiques
 Divaricatori autostatici



ADSON

AK 554/20 AK 555/20
 20,0 cm/8"



ANDERSON-ADSON

AK 556/20 AK 557/20
 20,0 cm/8"



ADSON

AK 558/27 AK 559/27
 27,0 cm/10³/₄"

WUNDHAKEN RETRACTORS SEPARADORES ECARTEURS DIVARICATORI

Selbsthaltende Wundsperrer
Selfretaining Retractors
Separadores autoestaticos
Ecarteurs autostatiques
Divaricatori autostatici

AA
AB
AC
AD
AE
AF
AK
AL
AO
KA
KK
X



ADSON
AK 560/27
27,0 cm/10³/₄"



ADSON-R
AK 561/01
27,0 cm/10³/₄"



ADSON-L
AK 561/02
27,0 cm/10³/₄"

Selbsthaltende Wundsperrer
 Selfretaining Retractors
 Separadores autoestaticos
 Ecarteurs autostatiques
 Divaricatori autostatici



ADSON-BABY
 AK 562/14
 14,0 cm/5¹/₂"

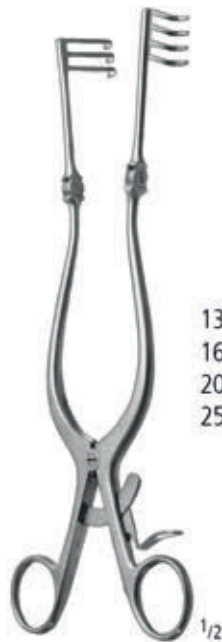

CONE

13,0 cm/5"
 16,5 cm/6¹/₂"
 20,0 cm/8"
 25,0 cm/10"

3 x 4
 3 x 4
 3 x 4
 3 x 4

^
 AK 564/13
 AK 564/16
 AK 564/20
 AK 564/25

∩
 AK 565/13
 AK 565/16
 AK 565/20
 AK 565/25

GEFÄSSINSTRUMENTE UND SONDEN
VESSEL INSTRUMENTS AND PROBES
INSTRUMENTAL VASCULAR Y SONDAS
INSTRUMENTS VAISSEUX ET SONDES
STRUMENTI VASCOLARI E SONDE

AL

nopa[®] instruments

Weitere Sonden finden Sie in unserem Katalog
„Allgemeine Chirurgie“ in Gruppe AL.

For further probes kindly refer to our catalogue
„General Surgery“, section AL.

Para sondas adicionales, por favor consulte nuestro
catálogo de „Cirugía general“, grupo AL.

Pour des sondes supplémentaires, consultez notre
catalogue „Chirurgie Generale“, section AL.

Per gli altri sonde, consultare il nostro catalogo
„Chirurgia Generale“, gruppo AL.



SONDEN PROBES SONDAS SONDES SONDE

Sonden
Probes
Sondas
Sondes
Sonde



Silber
silver
de plata
en argent
d'argento



11,5 cm/4¹/₂"
13,0 cm/5"
14,5 cm/5³/₄"
16,0 cm/6¹/₄"
18,0 cm/7"
20,0 cm/8"
25,0 cm/10"

	1,0 mm	2,0 mm
	AL 001/11	AL 002/11
	AL 001/13	AL 002/13
	AL 001/14	AL 002/14
	AL 001/16	AL 002/16
	AL 001/18	AL 002/18
	AL 001/20	AL 002/20
	AL 001/25	AL 002/25

AL 003/11
AL 003/13
AL 003/14
AL 003/16
AL 003/18
AL 003/20
AL 003/25

MYRTLE LEAF

AL 007/14
AL 007/16
AL 007/18
AL 007/20

STACKE
AL 013/10
10,5 cm/4¹/₄"
Ø 1,0 mm



11,5 cm/4¹/₂"
13,0 cm/5"
14,5 cm/5³/₄"
16,0 cm/6¹/₄"
18,0 cm/7"
20,0 cm/8"

AL 015/11
AL 015/13
AL 015/14
AL 015/16
AL 015/18
AL 015/20

DOYEN

AL 017/14

AL 020/11
AL 020/13
AL 020/14
AL 020/16
AL 020/18

NELATON

AL 022/16

AA
AB
AC
AD
AE
AF
AK
AL
AO
KA
KK
X

AL SONDEN PROBES SONDAS SONDES SONDE

Sonden und Watteträger
 Probes and Cotton Applicators
 Sondas y Porta-algodones
 Sondes et Porte-coton
 Sonde e Portacotone

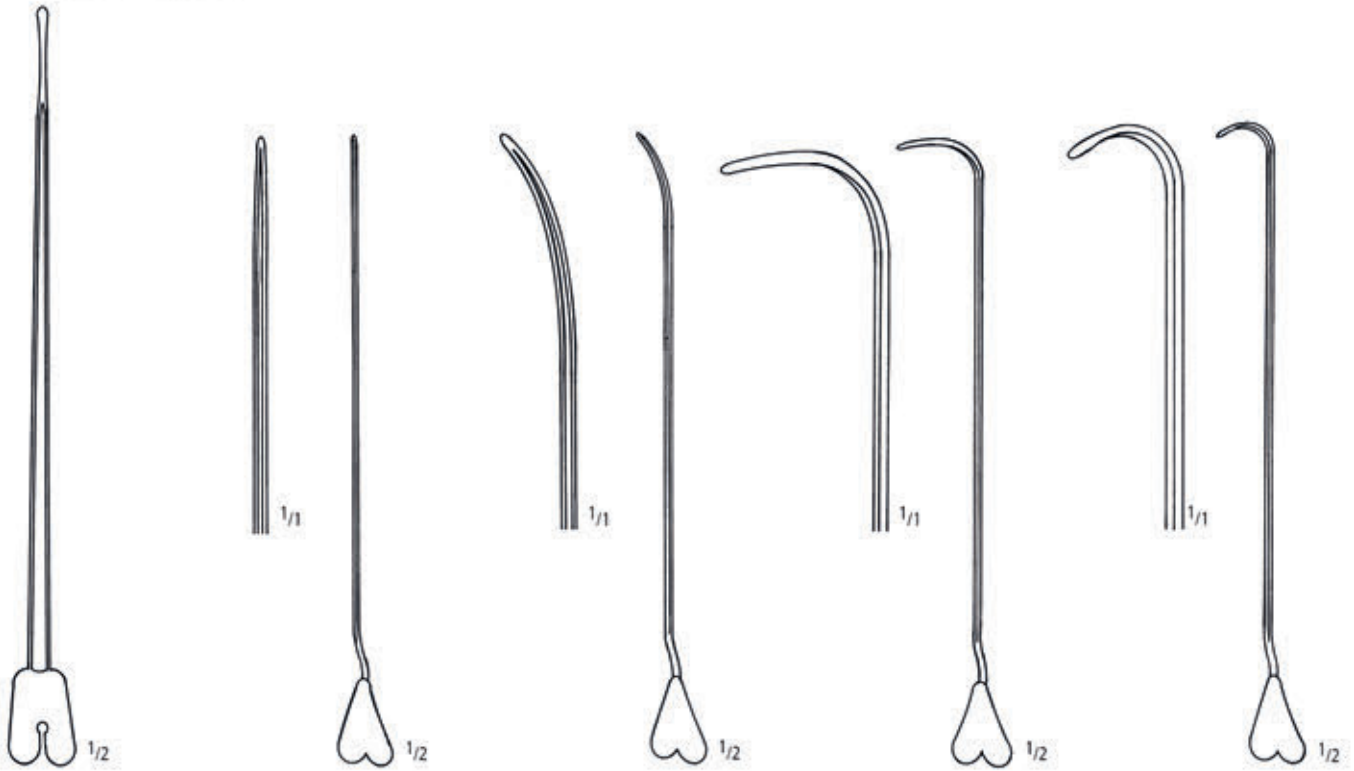

BRODIE

AL 026/20
 20,0 cm/8"

LOCKHART-MUMMERY

Fig. 1
 AL 030/01

Fig. 2
 AL 030/02

LOCKHART-MUMMERY

Fig. 3
 AL 030/03

Fig. 4
 AL 030/04

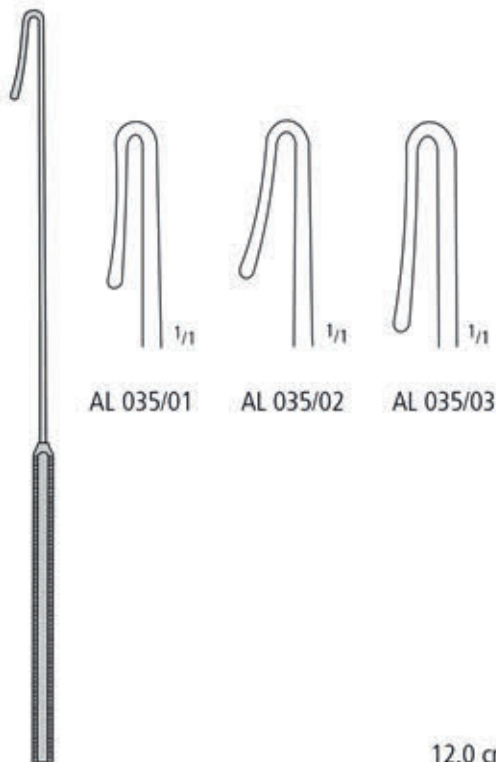

PRATT

21,0 cm/8¹/₄"

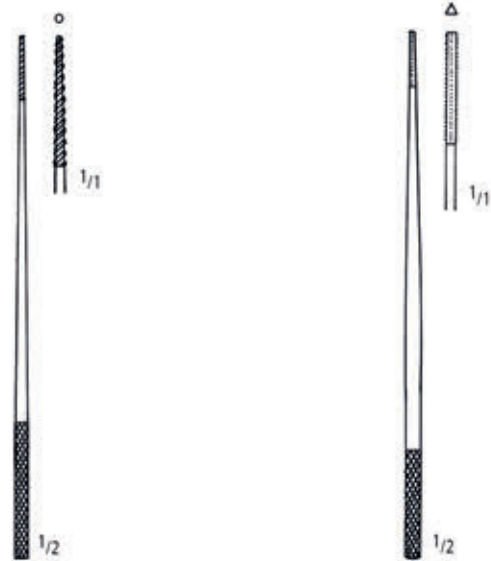

FARRELL

0,9 mm AL 100/12
 1,1 mm AL 100/14
 1,2 mm AL 100/16
 12,0 cm/4³/₄"
 14,0 cm/5¹/₂"
 16,5 cm/6¹/₂"
 18,0 cm/7"

FARRELL

0,9 mm AL 120/12
 1,1 mm AL 120/14
 1,2 mm AL 120/16
 12,0 cm/4³/₄"
 14,0 cm/5¹/₂"
 16,5 cm/6¹/₂"
 18,0 cm/7"

SONDEN PROBES SONDAS SONDES SONDE

Watteträger und Krampfader-Besteck
 Cotton Applicators and Varicose Vein Probe Set
 Porta-algodones y sonda para várices
 Porte-coton et trousse à varices
 Portacotone e astuccio per varici

AA
AB
AC
AD
AE
AF
AK
AL
AO
KA
KK
X



UCKERMANN
 AL 160/16
 16,0 cm/6 1/4"

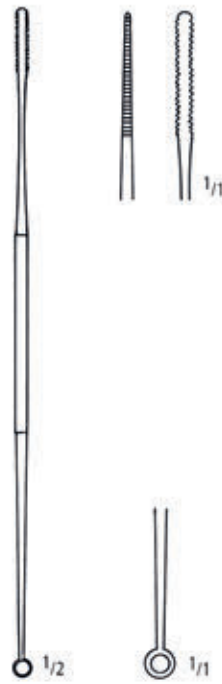

JOBSON-HORNE
 AL 162/18
 18,0 cm/7"

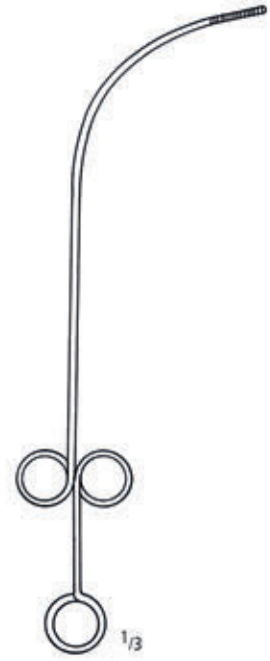

FEIN
 AL 170/28
 28,0 cm/11"

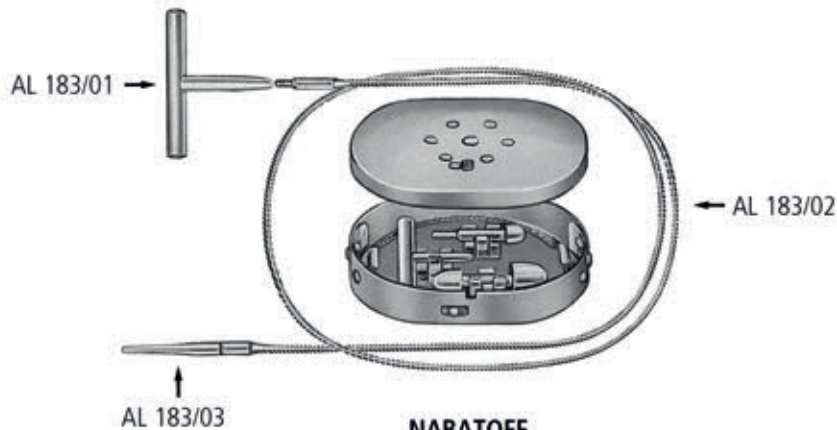
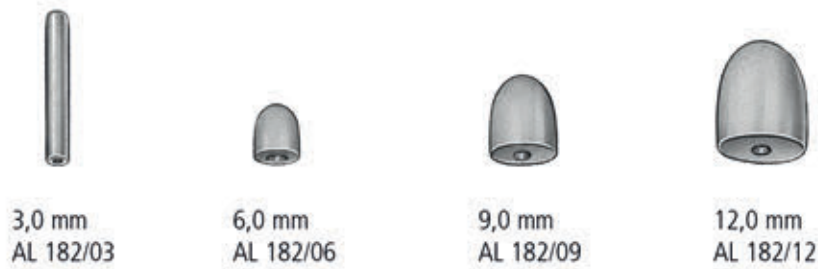

NABATOFF
 AL 180/00
 komplett-complete-completo-complet-completo

AL SONDEN PROBES SONDAS SONDES SONDE

Gefäß-Dilatatoren
 Vascular Dilators
 Dilatadores vasculares
 Dilatateurs vasculaires
 Dilatatori per vasi



biegsam
 malleable
 malleables
 malléables
 malleabili

- 1,0 mm
- 1,5 mm
- 2,0 mm
- 2,5 mm
- 3,0 mm
- 3,5 mm
- 4,0 mm
- 4,5 mm
- 5,0 mm

- 14,0 cm/5¹/₂"
- AL 190/10
- AL 190/15
- AL 190/20
- AL 190/25
- AL 190/30
- AL 190/35
- AL 190/40
- AL 190/45
- AL 190/50

- 21,0 cm/8¹/₄"
- AL 192/10
- AL 192/15
- AL 192/20
- AL 192/25
- AL 192/30
- AL 192/35
- AL 192/40
- AL 192/45
- AL 192/50

GARRETT

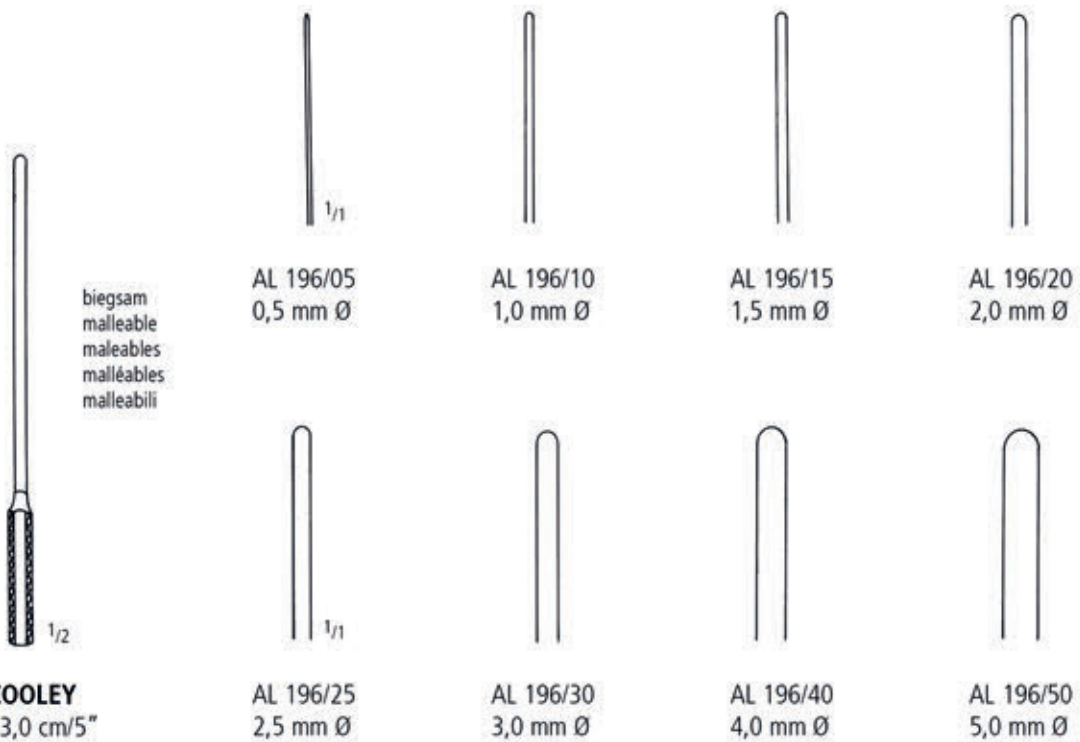

biegsam
 malleable
 malleables
 malléables
 malleabili

AL 196/05
 0,5 mm Ø

AL 196/10
 1,0 mm Ø

AL 196/15
 1,5 mm Ø

AL 196/20
 2,0 mm Ø

AL 196/25
 2,5 mm Ø

AL 196/30
 3,0 mm Ø

AL 196/40
 4,0 mm Ø

AL 196/50
 5,0 mm Ø

COOLEY
 13,0 cm/5"

SONDEN PROBES SONDAS SONDES SONDE

Gefäß-Dilatatoren
 Vascular Dilators
 Dilatadores vasculares
 Dilatateurs vasculaires
 Dilatatori per vasi

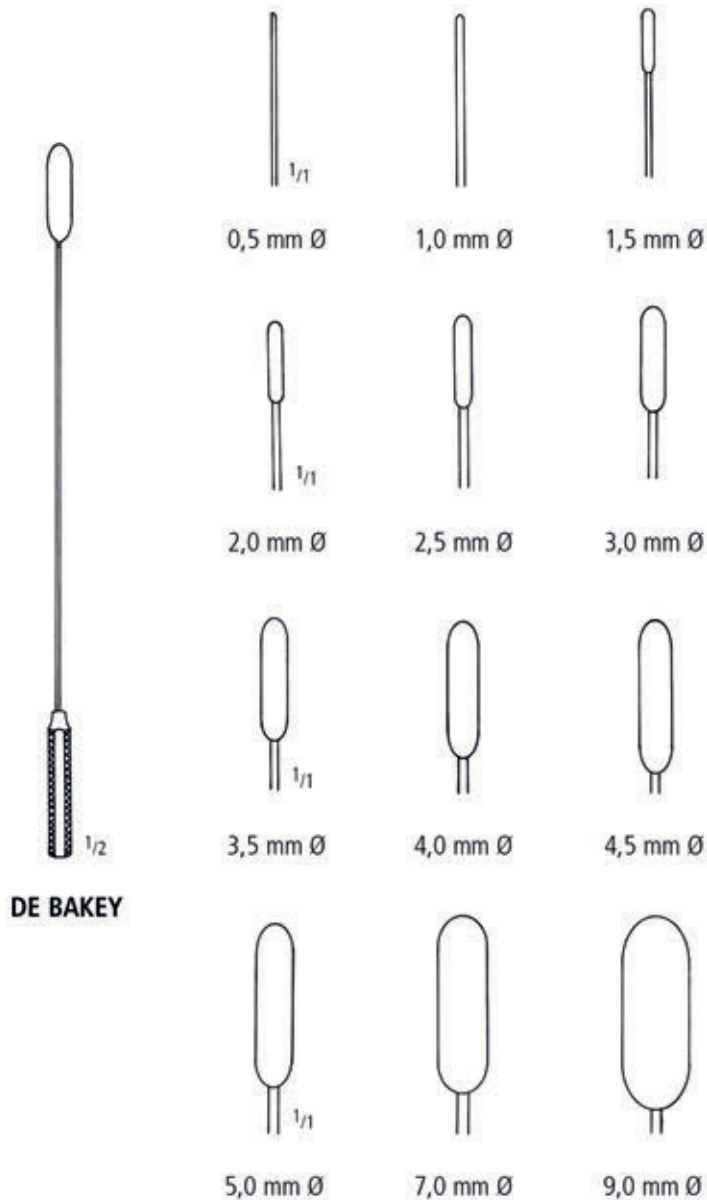

biegsam-malleable-maleables-malléables-malleabili

mm Ø	19,0 cm / 7 1/2"	35,0 cm / 14"
0,5	AL 200/05	AL 201/05
1,0	AL 200/10	AL 201/10
1,5	AL 200/15	AL 201/15
2,0	AL 200/20	AL 201/20
2,5	AL 200/25	AL 201/25
3,0	AL 200/30	AL 201/30
3,5	AL 200/35	AL 201/35
4,0	AL 200/40	AL 201/40
4,5	AL 200/45	AL 201/45
5,0	AL 200/50	AL 201/50
7,0	AL 200/70	AL 201/70
9,0	AL 200/90	AL 201/90

AA
 AB
 AC
 AD
 AE
 AF
 AK
AL
 AO
 KA
 KK
 X

Gefäß-Stripper
 Vascular Strippers
 Desobliteradores de vasos
 Tire-veines
 Tiravene



50,0 cm / 20"

 1/1
 AL 220/02
 2,0 mm

 AL 220/03
 3,0 mm

 AL 220/04
 4,0 mm

 1/1
 AL 220/06
 6,0 mm

 AL 220/07
 7,0 mm



 AL 220/08
 8,5 mm

 1/1
 AL 220/10
 10,0 mm

 AL 220/12
 12,0 mm

 AL 220/14
 14,0 mm



 1/2
 AL 222/12
 12,0 cm / 4³/₄"

SONDEN PROBES SONDAS SONDES SONDE

Fasszangen
Grasping Forceps
Pinzas para coger
Pincers pour saisir
Pinze per afferrare

AA

AB

AC

AD

AE

AF

AK

AL

AO

KA

KK

X



FRANKENFELDT
AL 248/36
36,0 cm/14¹/₄"



38,0 cm / 15¹/₄"



AL 250/38



AL 251/38



AL 252/38

- 1,0 mm KB 100/02
- 2,0 mm KB 100/04
- 3,0 mm KB 100/06
- 4,0 mm KB 100/08
- 5,0 mm KB 100/10
- 6,0 mm KB 100/12
- 7,0 mm KB 100/14
- 8,0 mm KB 100/16
- 9,0 mm KB 100/18
- 10,0 mm KB 100/20
- 11,0 mm KB 100/22
- 12,0 mm KB 100/24
- 13,0 mm KB 100/26
- 14,0 mm KB 100/28
- 15,0 mm KB 100/30
- 16,0 mm KB 100/32
- 17,0 mm KB 100/34
- 18,0 mm KB 100/36
- 19,0 mm KB 100/38
- 20,0 mm KB 100/40
- 21,0 mm KB 100/42
- 22,0 mm KB 100/44
- 23,0 mm KB 100/46
- 24,0 mm KB 100/48
- 25,0 mm KB 100/50
- 26,0 mm KB 100/52
- 27,0 mm KB 100/54
- 28,0 mm KB 100/56
- 29,0 mm KB 100/58
- 30,0 mm KB 100/60

- 1,5 mm KB 100/03
- 2,5 mm KB 100/05
- 3,5 mm KB 100/07
- 4,5 mm KB 100/09
- 5,5 mm KB 100/11
- 6,5 mm KB 100/13
- 7,5 mm KB 100/15
- 8,5 mm KB 100/17
- 9,5 mm KB 100/19
- 10,5 mm KB 100/21
- 11,5 mm KB 100/23
- 12,5 mm KB 100/25
- 13,5 mm KB 100/27
- 14,5 mm KB 100/29
- 15,5 mm KB 100/31
- 16,5 mm KB 100/33
- 17,5 mm KB 100/35
- 18,5 mm KB 100/37
- 19,5 mm KB 100/39



HEGAR

KB 110/14

Satz zu 14 Dilatatoren 4,0 mm - 17,0 mm
 Set of 14 dilators 4,0 mm - 17,0 mm
 Juego de 14 dilatadores 4,0 mm - 17,0 mm
 Jeu de 14 dilateurs 4,0 mm - 17,0 mm
 Serie di 14 dilatatori 4,0 mm - 17,0 mm

KB 110/26

Satz zu 26 Dilatatoren 1,0 mm - 26,0 mm
 Set of 26 dilators 1,0 mm - 26,0 mm
 Juego de 26 dilatadores 1,0 mm - 26,0 mm
 Jeu de 26 dilateurs 1,0 mm - 26,0 mm
 Serie di 26 dilatatori 1,0 mm - 26,0 mm

KB 112/14

Satz zu 14 Dilatatoren 4,0 mm - 17,0 mm
 Set of 14 dilators 4,0 mm - 17,0 mm
 Juego de 14 dilatadores 4,0 mm - 17,0 mm
 Jeu de 14 dilateurs 4,0 mm - 17,0 mm
 Serie di 14 dilatatori 4,0 mm - 17,0 mm



HEGAR



HEGAR

1,0/ 2,0 mm	KB 113/02
3,0/ 4,0 mm	KB 113/04
5,0/ 6,0 mm	KB 113/06
7,0/ 8,0 mm	KB 113/08
9,0/10,0 mm	KB 113/10
11,0/12,0 mm	KB 113/12
13,0/14,0 mm	KB 113/14
15,0/16,0 mm	KB 113/16
17,0/18,0 mm	KB 113/18
19,0/20,0 mm	KB 113/20
21,0/22,0 mm	KB 113/22
23,0/24,0 mm	KB 113/24
25,0/26,0 mm	KB 113/26

KB 114/08

Satz zu 8 Dilatatoren 3,0/4,0 mm - 17,0/18,0 mm
 Set of 8 dilators 3,0/4,0 mm - 17,0/18,0 mm
 Juego 8 dilatadores 3,0/4,0 mm - 17,0/18,0 mm
 Jeu de 8 dilateurs 3,0/4,0 mm - 17,0/18,0 mm
 Serie di 8 dilatatori 3,0/4,0 mm - 17,0/18,0 mm

KB 114/13

Satz zu 13 Dilatatoren 1,0/2,0 mm - 25,0/26,0 mm
 Set of 13 dilators 1,0/2,0 mm - 25,0/26,0 mm
 Juego de 13 dilatadores 1,0/2,0 mm - 25,0/26,0 mm
 Jeu de 13 dilateurs 1,0/2,0 mm - 25,0/26,0 mm
 Serie di 13 dilatatori 1,0/2,0 mm - 25,0/26,0 mm



HEGAR

KB 115/08

Satz zu 8 Dilatatoren 3,0/4,0 mm - 17,0/18,0 mm
 Set of 8 dilators 3,0/4,0 mm - 17,0/18,0 mm
 Juego 8 dilatadores 3,0/4,0 mm - 17,0/18,0 mm
 Jeu de 8 dilateurs 3,0/4,0 mm - 17,0/18,0 mm
 Serie di 8 dilatatori 3,0/4,0 mm - 17,0/18,0 mm

SAUGROHRE UND KANÜLEN
SUCTION TUBES AND CANNULAE
TUBOS DE ASPIRACION Y CANULAS
TUBES D'ASPIRATION ET CANULES
TUBI D'ASPIRAZIONE E CANNULE

AO

nopa[®] instruments

Weitere Instrumente für den Bereich AO finden Sie in unserem Katalog „Allgemeine Chirurgie“ in der Gruppe AO.

For further instruments of the section AO kindly refer to our catalogue „General Surgery“, section AO.

Para instrumentos adicionales del este grupo AO, por favor consulte nuestro catálogo de „Cirugía general“, grupo AO.

Pour instruments supplémentaires AO, consultez notre catalogue „Chirurgie Generale“, section AO.

Per altri strumenti de questo gruppo AO, consultare il nostro catalogo „Chirurgia Generale“, gruppo AO.



Saugrohre
Suction Tubes
Tubos de aspiración
Canules d'aspiration
Cannule per aspirazione

AA
AB
AC
AD
AE
AF
AK
AL
AO
KA
KK
X



YANKAUER
AO 400/00
27,0 cm/11"



WALTON-YANKAUER
AO 404/00
32,5 cm/13"



ANDREWS-PYNCHON
AO 406/00
23,5 cm/9¹/₃"



DE BAKEY
AO 408/00
27,5 cm/10³/₄"

Saugrohre
Suction Tubes
Tubos de aspiración
Canules d'aspiration
Cannule per aspirazione



COUPLAND
AO 410/00



BYRD
1,5 mm AO 412/15
2,5 mm AO 412/25
3,5 mm AO 412/35



POOLE
AO 420/22
10,0 mm



POOLE
AO 421/22
8,0 mm



BABY-POOLE
AO 422/20
5,5 mm

Saugrohre
Suction Tubes
Tubos de aspiración
Canules d'aspiration
Cannule per aspirazione

8,0 mm



COOLEY
AO 424/01
33,0 cm/13"

8,0 mm



COOLEY
AO 424/02
35,0 cm/14"

6,0 mm



COOLEY
AO 424/03
30,0 cm/12"

10,0 mm



COOLEY
AO 424/04
31,0 cm/12¹/₄"

AA
AB
AC
AD
AE
AF
AK
AL
AO
KA
KK
X

Saugrohre
Suction Tubes
Tubos de aspiración
Canules d'aspiration
Cannule per aspirazione

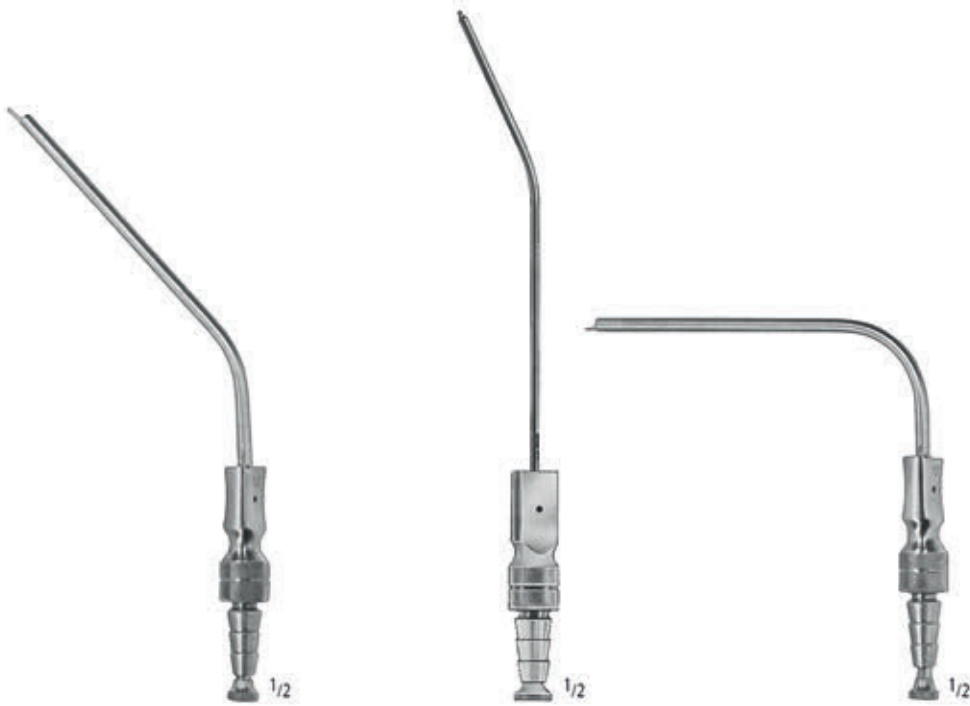

FRAZIER

6 Charr.	AO 430/06
8 Charr.	AO 430/08
10 Charr.	AO 430/10
12 Charr.	AO 430/12

PLESTER

1,5 mm	AO 432/15
2,0 mm	AO 432/20
2,5 mm	AO 432/25
3,0 mm	AO 432/30

FERGUSSON

5 Charr.	AO 434/05
6 Charr.	AO 434/06
7 Charr.	AO 434/07
8 Charr.	AO 434/08
9 Charr.	AO 434/09
10 Charr.	AO 434/10
12 Charr.	AO 434/12



	L	L	L	L
	130 mm	150 mm	180 mm	220 mm
Ø 1,5 mm	AO 440/13	AO 440/15	AO 440/18	AO 440/22
Ø 2,0 mm	AO 441/13	AO 441/15	AO 441/18	AO 441/22
Ø 2,5 mm	AO 442/13	AO 442/15	AO 442/18	AO 442/22
Ø 3,5 mm	AO 443/13	AO 443/15	AO 443/18	AO 443/22



ADSON
AO 450/04
21,0 cm/8 1/4"
Ø 4,0 mm

KNOCHENINSTRUMENTE
BONE INSTRUMENTS
INSTUMENTOS PARA HUESOS
INSTRUMENTS DES OS
STRUMENTI PER OSSA

KA

nopa[®] instruments

Bohrapparate u. Zubehör	Seite	219-221
Drilling devices and accessories	Page	219-221
Taladradoras y accesorios	Página	219-221
Perceuses et accessoires	Page	219-221
Alesatrici e accessori	Pagina	219-221
Drahtzangen	Seite	222-223
Wire forceps	Page	222-223
Pinzas para hilos	Página	222-223
Pinces à fil	Page	222-223
Tenaglie fili	Pagina	222-223
Hohlmeißel- und Knochensplitterzangen	Seite	224-232
Bone rongeurs and bone cutting forceps	Page	224-232
Pinzas gubias y pinzas cortantes para huesos	Página	224-232
Pinces gouges et pinces coupantes à os	Page	224-232
Pinze sgorbie e pinze cesoie per ossa	Pagina	224-232



Bohrapparate und Zubehör
 Drilling devices and accessories
 Taladradoras y accesorios
 Perceuses et accessoires
 Alesatrici e accessori



KA 120/00
 Akku Bohrrapparat / Accu power drill

Spannung / Voltage	9,6 Volt
Drehzahl / Revolutions	0-750 U/min
Leistung / Power	130/200 Watt



KA 121/00
 Luft Bohrrapparat / Air power drill

Drehzahl / Revolutions	600 U/min
Druck / Compression	6,5 bar

AA
 AB
 AC
 AD
 AE
 AF
 AK
 AL
 AO
KA
 KK
 X

Zubehör für KA 120/00 und KA 121/00
 Accessories for KA 120/00 and KA 121/00
 Accesorios para KA 120/00 y KA 121/00
 Accessoires pour KA 120/00 et KA 121/00
 Accessori per KA 120/00 e KA 121/00



KA 122/10
 Adapter mit Jacobs Spannfutter
 Adapter with Jacobs chuck



KA 122/16
 Schnellspannfutter für Kirschnerdrähte 0,8 bis 3,0 mm
 Quick-action chuck for Kirschner wires 0,8 to 3,0 mm



KA 122/11
 Adapter für AO Schaft
 Adapter for AO shank



KA 123/01
 Osteotomie Säge oszillierend
 Sagittal saw oscillating



KA 122/13
 Adapter für DIN Schaft
 Adapter for DIN shank



KA 123/02
 Sternum Säge
 Sternum Saw



KA 122/14
 Adapter für Harris Schaft
 Adapter for Harris shank



KA 122/15
 Adapter für Hudson Schaft
 Adapter for Hudson shank

Ladegerät / Akku
 Charger / Battery
 Cargador / acumulador
 Chargeur d'accus / accumulateur
 Caricabatteria / accumulatore



KA 124/01
 Ladegerät Netzspannung 115V / 240V Ladezeit 60 min
 Charger main voltage 115V / 240V charging time 60 min



KA 124/02
 Ladegerät für 2 Akkus Netzspannung 115V / 240V Ladezeit 60 min
 Charger for 2 batteries main voltage 115V / 240V Charging time 60 min



KA 124/10
 9,6V 2600mAh



KA 124/11
 12V 2600mAh

AA
 AB
 AC
 AD
 AE
 AF
 AK
 AL
 AO
KA
 KK
 X

Drahtzangen
Wire Forceps
Pinzas para hilos
Pincers à fil
Tenaglie fili



KA 270/15
15,0 cm/6"



KA 271/16
16,0 cm/6¹/₄"



KA 272/18
18,0 cm/7"

für weiche Drähte bis 2,0 mm Ø
for soft wires up to 2,0 mm Ø
para hilos blandos hasta 2,0 mm de Ø
pour fils mous jusqu'à 2,0 mm de Ø
per fili morbidi sino a mm 2,0 di Ø

für harte Drähte bis 1,5 mm Ø
for hard wires up to 1,5 mm Ø
para hilos duros hasta 1,5 mm de Ø
pour fils durs jusqu'à 1,5 mm de Ø
per fili duri sino a mm 1,5 di Ø

nopa[®]
TUC



KA 273/17
17,0 cm/6³/₄"



für weiche Drähte bis 2,0 mm Ø
for soft wires up to 2,0 mm Ø
para hilos blandos hasta 2,0 mm de Ø
pour fils mous jusqu'à 2,0 mm de Ø
per fili morbidi sino a mm 2,0 di Ø

für harte Drähte bis 1,6 mm Ø
for hard wires up to 1,6 mm Ø
para hilos duros hasta 1,6 mm de Ø
pour fils durs jusqu'à 1,6 mm de Ø
per fili duri sino a mm 1,6 di Ø



KA 273/22
22,0 cm/8³/₄"

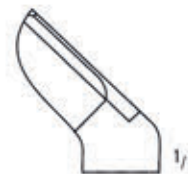

für Drähte bis 2,5 mm Ø
for wires up to 2,5 mm Ø
para hilos hasta 2,5 mm de Ø
pour fils jusqu'à 2,5 mm de Ø
per fili sino a mm 2,5 di Ø

Drahtzangen
Wire Forceps
Pinzas para hilos
Pinces à fil
Tenaglie fili



KA 275/47
47,0 cm/18¹/₂"

AA
AB
AC
AD
AE
AF
AK
AL
AO
KA
KK
X

Hohlmeißelzangen
 Bone Rongeurs
 Pinzas-gubias
 Pincès-gouges
 Pinze-sgorbie



MARQUARDT
 KA 821/20
 20,0 cm/8"



MAYFIELD
 KA 823/17
 17,0 cm/6³/₄"



BEYER
 KA 830/18
 18,0 cm/7"



ZAUFAL-JANSEN
 KA 835/18
 18,0 cm/7"

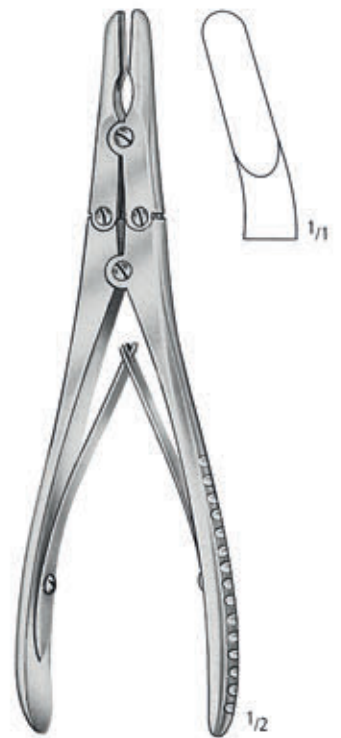

RUSKIN
 KA 836/18
 18,0 cm/7"

Hohlmeißelzangen
 Bone Rongeurs
 Pinzas-gubias
 Pincès-gouges
 Pinze-sgorbie

AA
 AB
 AC
 AD
 AE
 AF
 AG
 AH
 AI
 AJ
 AK
 AL
 AO
KA
 KB
 KC
 KD
 KE
 KF
 KG
 KH
 KI
 KJ
 KK
 XL
 XM
 XN
 XO
 XP
 XQ
 XR

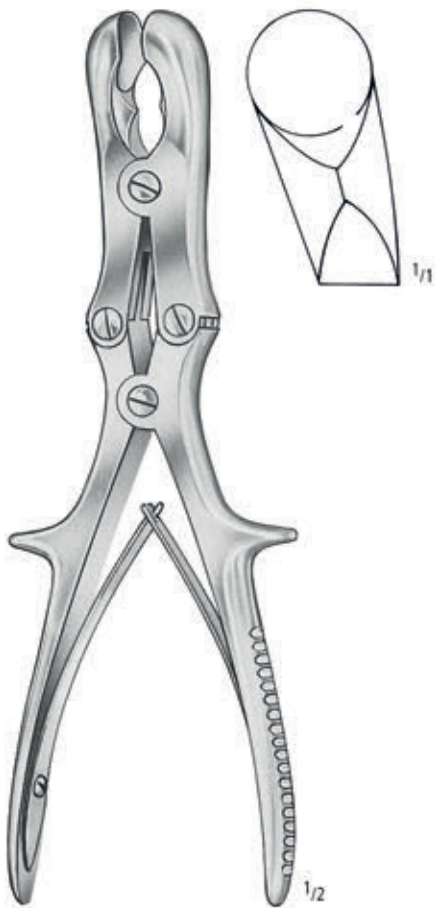

SEMB
 KA 838/22
 22,5 cm/9"



STILLE
 KA 840/23
 23,0 cm/9"



STILLE-RUSKIN
 KA 841/23
 23,0 cm/9"

Hohlmeißelzangen
 Bone Rongeurs
 Pinzas-gubias
 Pincès-gouges
 Pinze-sgorbie



ROETTGEN-RUSKIN
 KA 845/24
 24,0 cm/9¹/₂"



LEKSELL-STILLE
 24,0 cm/9¹/₂"



KA 848/01
 8 mm

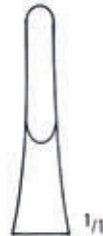

KA 848/02
 4 mm



STILLE-LUER
 22,0 cm/8³/₄"

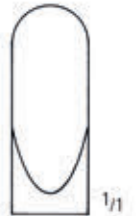

KA 852/22



KA 853/22

Hohlmeißelzangen
 Bone Rongeurs
 Pinzas-gubias
 Pincès-gouges
 Pinze-sgorbie

AA
 AB
 AC
 AD
 AE
 AF
 AK
 AL
 AO
KA
 KK
 X

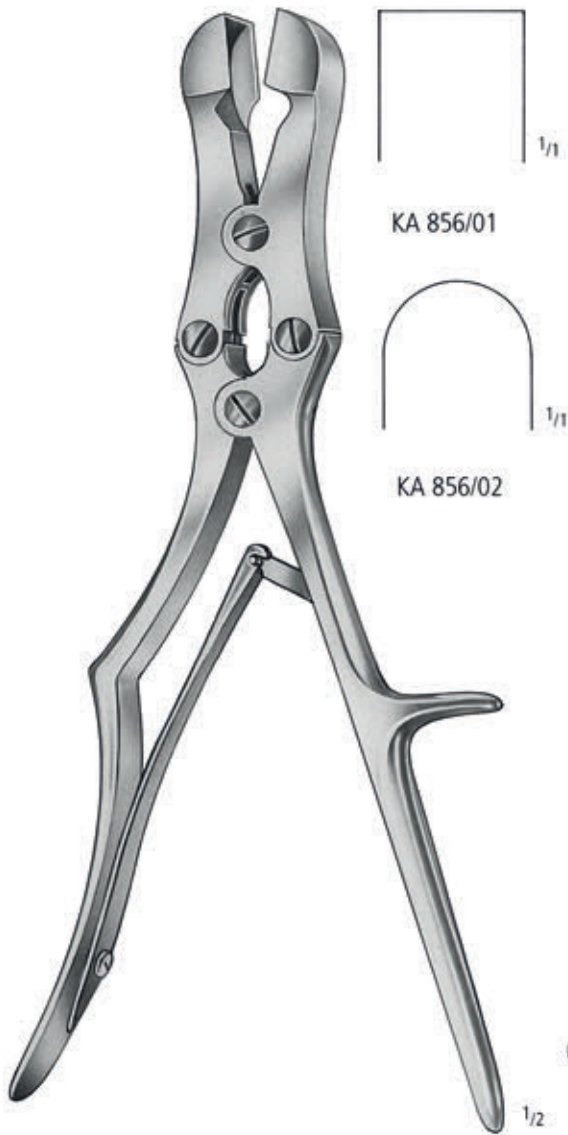

SAUERBRUCH
 30,0 cm/12"



FRYKHOLM
 KA 859/23
 23,0 cm/9"

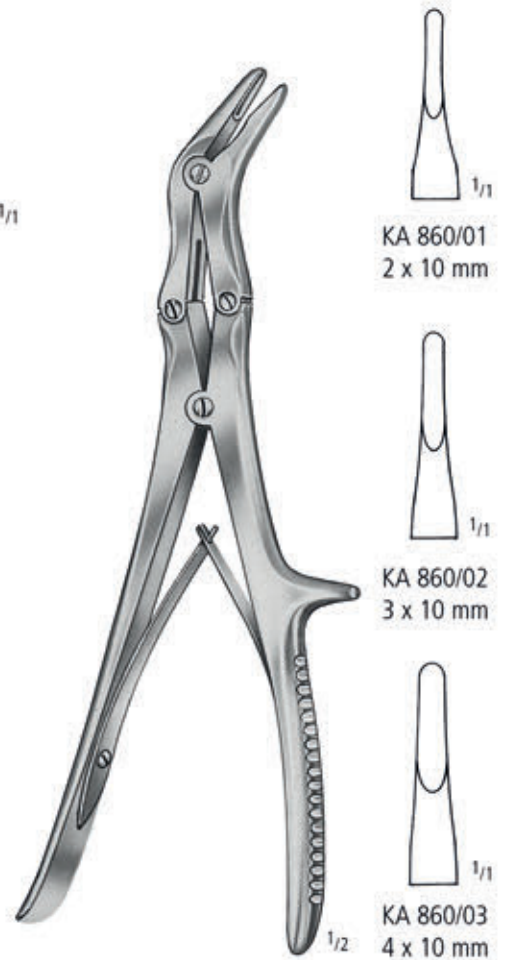

ECHLIN
 23,0 cm/9"

Hohlmeißelzangen
 Bone Rongeurs
 Pinzas-gubias
 Pincès-gouges
 Pinze-sgorbie



RUSKIN
 KA 862/23
 23,0 cm/9"



SMITH-PETERSON
 24,0 cm/9 1/2"



KA 863/03
 3 mm

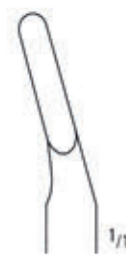

KA 863/04
 4 mm

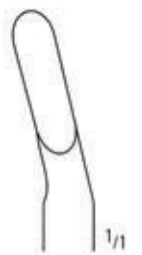

KA 863/05
 5 mm



KA 863/13
 3 mm



KA 863/14
 4 mm



KA 863/15
 5 mm

Knochensplitterzangen
 Bone Cutting Forceps
 Pinzas cortantes para huesos
 Pinces coupantes à os
 Cesioie per ossa

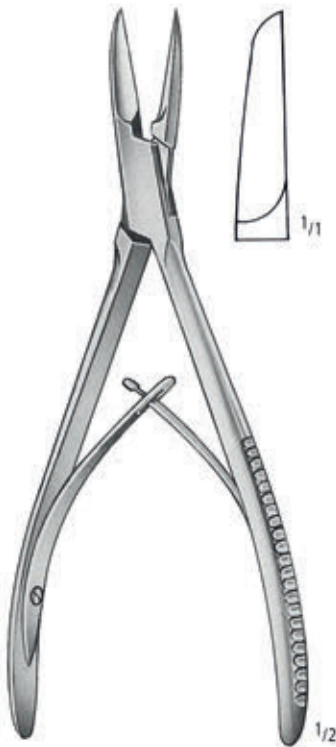

COTTLE KAZANJIAN
 KA 870/19
 19,0 cm/7¹/₂"



CLEVELAND-GARDNER
 KA 872/16
 18,0 cm/6¹/₄"



MARKWALDER
 KA 874/20
 20,0 cm/8"

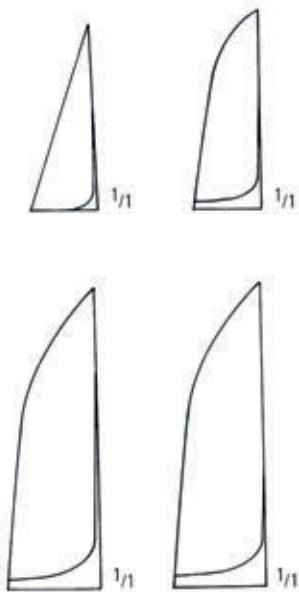

KA 880/14
 KA 880/17
 KA 880/19
 KA 880/22



LISTON
 14,0 cm/5¹/₂"
 17,0 cm/6³/₄"
 19,0 cm/7¹/₂"
 22,0 cm/8³/₄"

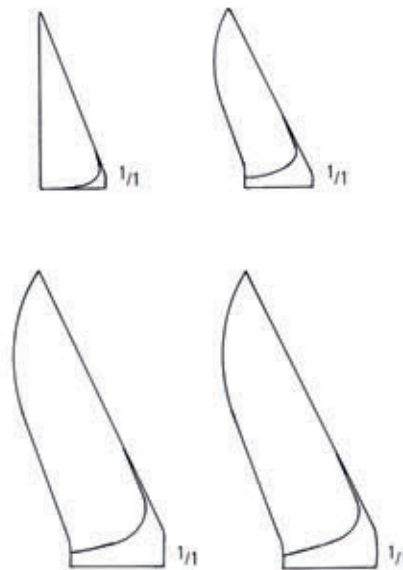

KA 881/14
 KA 881/17
 KA 881/19
 KA 881/22



LITTAUER-LISTON
 KA 882/15
 15,0 cm/6"

AA
 AB
 AC
 AD
 AE
 AF
 AK
 AL
 AO
 KA
 KK
 X

Knochensplitterzangen
 Bone Cutting Forceps
 Pinzas cortantes para huesos
 Pincas coupantes à os
 Cesioie per ossa

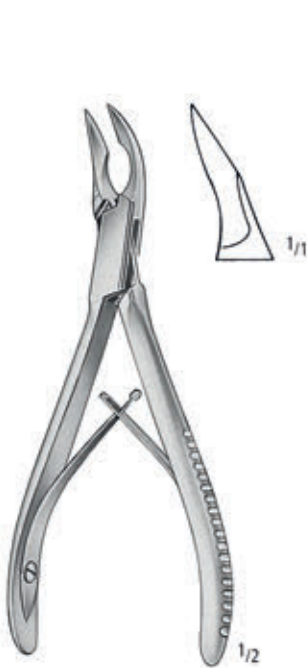

CLEVELAND
 KA 884/15
 15,0 cm/6"



CLEVELAND
 KA 884/17
 17,0 cm/6³/₄"



KA 885/12
 12,0 cm/4³/₄"



RUSKIN-LISTON
 18,5 cm/7¹/₄"



MC INDOE
 KA 888/17
 17,5 cm/7"



WALTON-LISTON
 KA 889/01
 15,0 cm/6"

Knochensplitterzangen
 Bone Cutting Forceps
 Pinzas cortantes para huesos
 Pinces coupantes à os
 Cesioie per ossa

AA
 AB
 AC
 AD
 AE
 AF
 AK
 AL
 AO
KA
 KK
 X



KA 890/00



KA 890/30

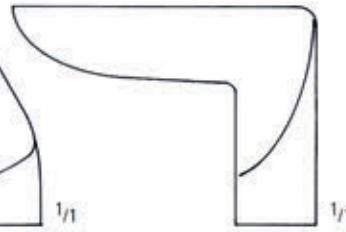

KA 890/90



LISTON-KEY (TUDOR-EDWARDS)

KA 892/27
 27,0 cm/10¹/₂"

Knochensplitterzangen
 Bone Cutting Forceps
 Pinzas cortantes para huesos
 Pinces coupantes à os
 Cesioie per ossa



SEMB
 KA 893/24
 24,0 cm/9 1/2"

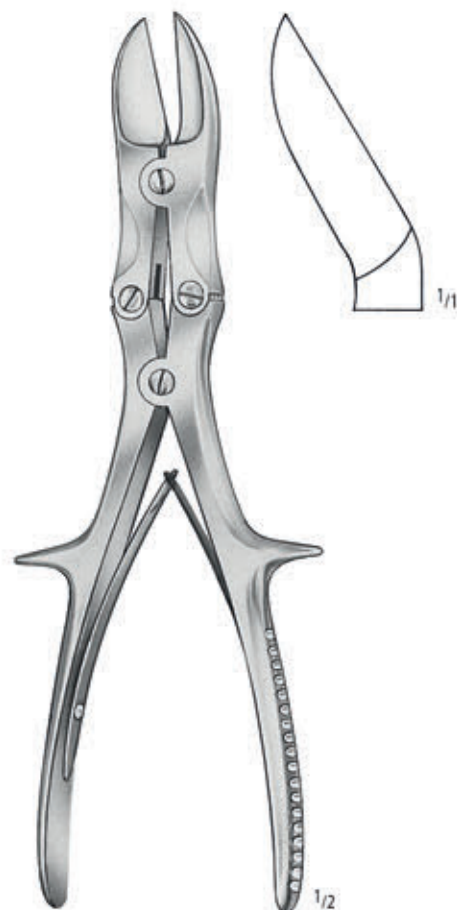

LISTON
 KA 894/23
 23,5 cm/9 1/4"

HERZ/THORAX
CARDIOVASCULAR
CARDIOVASCULAR
CARDIOVASCULAIRE
CARDIOVASCOLARE

KK

nopa[®] instruments

Rippen-Instrumente	Seite	235-238
Rib Instruments	Page	235-238
Instrumentos costales	Página	235-238
Instruments des côtes	Page	235-238
Strumenti per costali	Pagina	235-238
Rippensperrer	Seite	239-250
Rib Spreaders	Page	239-250
Separadores costales	Página	239-250
Ecarteurs des côtes	Page	239-250
Divaricatori costali	Pagina	239-250
Clips, Bulldogklemmen	Seite	257-263
Clips, Bulldog Clamps	Page	257-263
Clips, Clamps Bulldog	Página	257-263
Clips, Clamps Bulldog	Page	257-263
Clips, Pinze Bulldog	Pagina	257-263
Atrauma-Klemmen	Seite	260-296
Atrauma Forceps	Page	260-296
Pinzas Atrauma	Página	260-296
Pinces atraumatiques	Page	260-296
Pinze Atrauma	Pagina	260-296



Rippen-Raspatorien
 Costal periosteotomes
 Periostótomos para costillas
 Rugines raspatoires
 Periostotomi costali

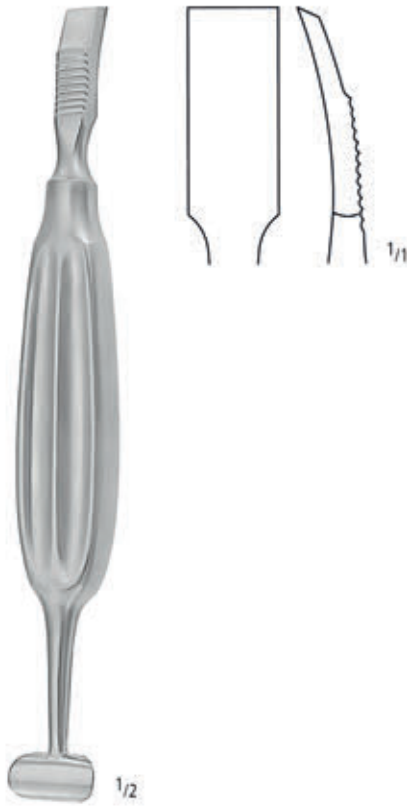

ALEXANDER
 KK 001/20
 20,0 cm/8"

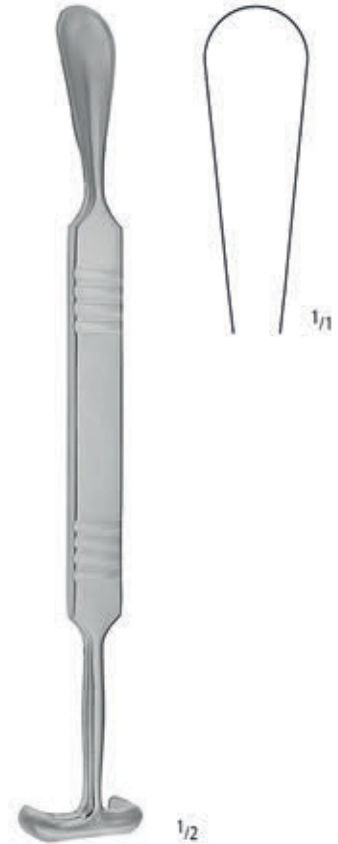

MATSON
 KK 002/22
 22,0 cm/8³/₄"



DOYEN
 KK 004/01
 17,0 cm/6³/₄"

DOYEN
 KK 004/02
 17,0 cm/6³/₄"



DOYEN
 KK 004/03
 18,0 cm/7"

DOYEN
 KK 004/04
 18,0 cm/7"

AA
 AB
 AC
 AD
 AE
 AF
 AK
 AL
 AO
 KA
 KK
 X

Rippen-Raspatorien
 Costal periosteotomes
 Periostótomos para costillas
 Rugines raspatoires
 Periostotomi costali

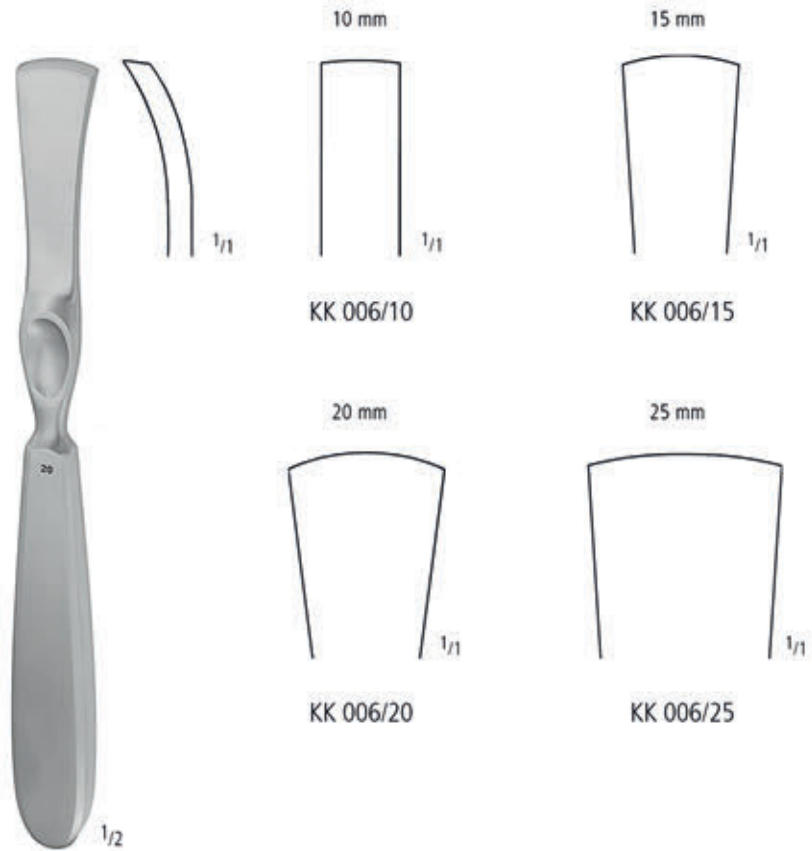

LAMBOTTE
 21,0 cm/8¹/₄"



SEMB

Knochen- und Rippenscheren
 Bone and Rib Shears
 Cizallas para huesos, Costotomos
 Cisailles pour os, Costotomes
 Pinze per ossa e costole, Costotomi



KK 010/23
 23,0 cm/9"



KK 011/22
 22,0 cm/8³/₄"



GLUCK
 KK 013/22
 22,0 cm/8³/₄"



BETHUNE
 KK 018/34
 34,0 cm/13¹/₂"



SAUERBRUCH
 KK 019/26
 26,0 cm/10¹/₄"



CORYLLOS
 KK 021/35
 35,0 cm/13³/₄"



KK 023/35
 35,0 cm/13³/₄"

AA
 AB
 AC
 AD
 AE
 AF
 AK
 AL
 AO
 KA
 KK
 X

Knochen- und Rippenscheren
 Bone and Rib Shears
 Cizallas para huesos, Costotomos
 Cisailles pour os, Costotomes
 Pinze per ossa e costole, Costotomi



GIERTZ-STILLE
 KK 024/27
 27,0 cm/10¹/₂"



BRUNNER



KK 027/32
 32,0 cm/12¹/₂"



KK 029/32
 32,0 cm/12¹/₂"



LEBSCHE
 KK 040/25
 25,0 cm/10"

Rippensperrer
 Rib Spreaders
 Separadores costales
 Ecarteurs des côtes
 Divaricatori costali



B 40 mm H 150 mm C 110 mm

I.M.A. MAMMARIA RETRACTOR
 KK 056/00

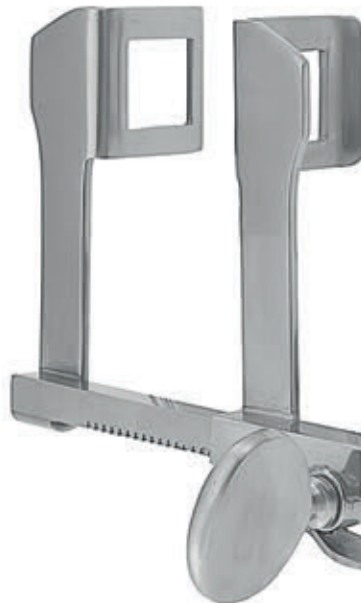

B 30 mm H 30 mm C 90 mm

HAIGHT
 KK 080/00

AA
 AB
 AC
 AD
 AE
 AF
 AK
 AL
 AO
 KA
 X
KK

Rippensperrer
 Rib Spreaders
 Separadores costales
 Ecarteurs des côtes
 Divaricatori costali



TUFFIER
 KK 084/16

B	H	C
45 mm	45 mm	160 mm

BADGLEY
 KK 086/18

B	H	C
44 mm	48 mm	178 mm

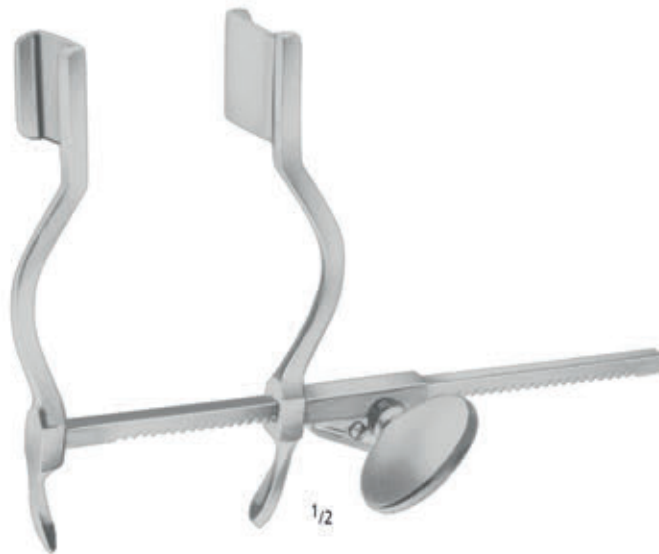

HERTZLER
 KK 088/10

B	H	C
20 mm	25 mm	105 mm

Rippensperrer
 Rib Spreaders
 Separadores costales
 Ecarteurs des côtes
 Divaricatori costali

AA

AB

AC

AD

AE

AF

AK

AL

AO

KA

KK

X



B	H	C	FINOCCHIETTO-BABY
18 mm	20 mm	75 mm	KK 090/07



B	H	C	FINOCCHIETTO
30 mm	45 mm	150 mm	KK 092/01
46 mm	62 mm	190 mm	KK 092/02
80 mm	65 mm	190 mm	KK 092/03

Rippensperrer
Rib Spreaders
Separadores costales
Ecarteurs des côtes
Divaricatori costali

ALUMINIUM



B	H	C	ANKENEY
19 mm	25 mm	127 mm	KK 093/04

Rippensperrer
 Rib Spreaders
 Separadores costales
 Ecarteurs des côtes
 Divaricatori costali



B	H	C	ANKENEY
35 mm	32 mm	178 mm	KK 093/06

AA

AB

AC

AD

AE

AF

AK

AL

AO

KA

KK

X



Rippensperrer
 Rib Spreaders
 Separadores costales
 Ecarteurs des côtes
 Divaricatori costali

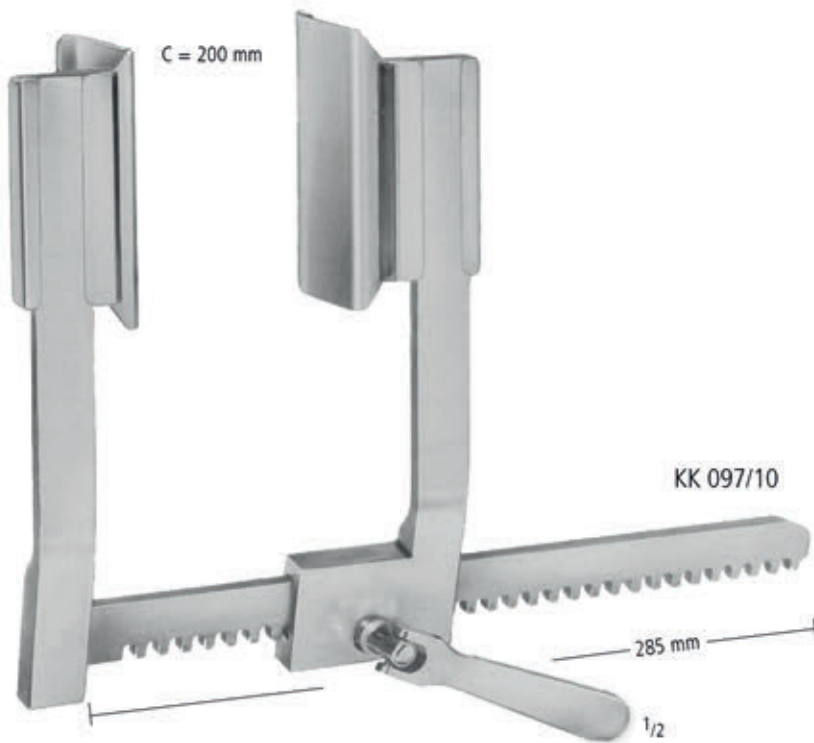

DE BAKEY

- KK 097/00 = 1 x KK 097/10
- + 2 x KK 097/01
- + 2 x KK 097/02
- + 2 x KK 097/03



KK 097/01
 60 x 60 mm



KK 097/02
 50 x 80 mm



KK 097/03
 40 x 100 mm

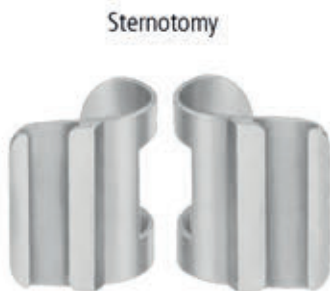

KK 097/05
 50 x 66 mm



KK 097/04
 80 x 60 mm

AA
 AB
 AC
 AD
 AE
 AF
 AK
 AL
 AO
 KA
 KK
 X

Rippensperrer
 Rib Spreaders
 Separadores costales
 Ecarteurs des côtes
 Divaricatori costali

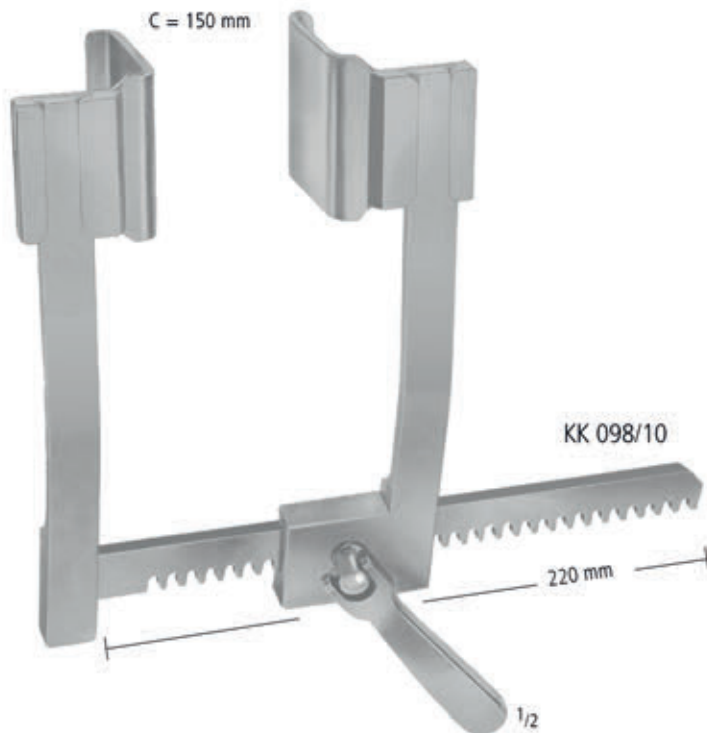

KK 098/01
 30 x 30 mm



KK 098/02
 40 x 40 mm



KK 098/03
 50 x 50 mm

DE BAKEY

- KK 098/00 = 1 x KK 098/10
- + 2 x KK 098/01
- + 2 x KK 098/02
- + 2 x KK 098/03

Rippensperrer
 Rib Spreaders
 Separadores costales
 Ecarteurs des côtes
 Divaricatori costali

AA

AB

AC

AD

AE

AF

AK

AL

AO

KA

KK

X

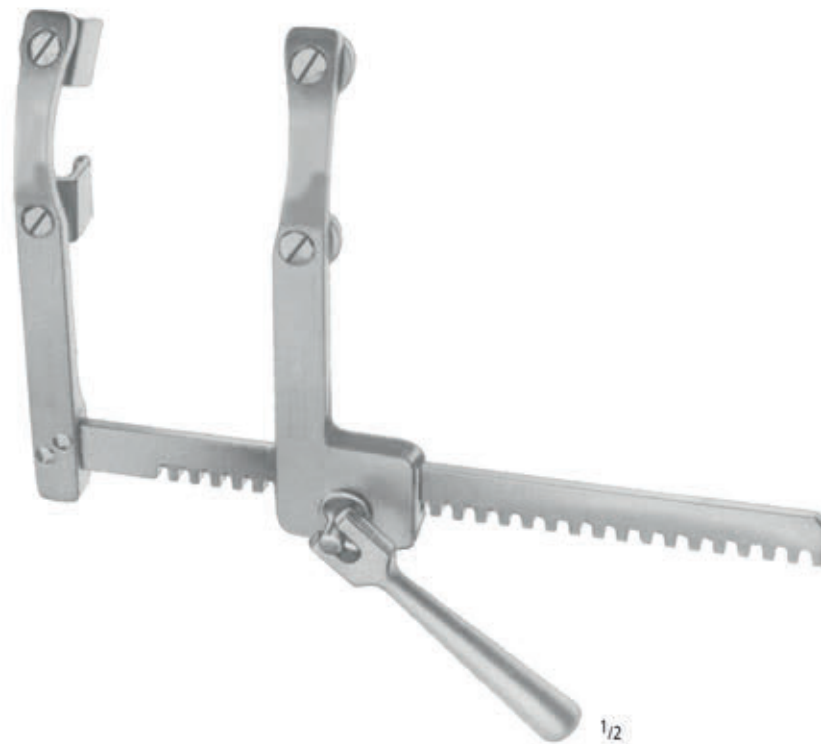
**MORSE FAVALORO**

B	H	C	
19 mm	29 mm	200 mm	KK 099/01
12 mm	20 mm	200 mm	KK 099/02

Rippensperrer
 Rib Spreaders
 Separadores costales
 Ecarteurs des côtes
 Divaricatori costali

ALUMINIUM



FINOCCHIETTO

B	H	C	
40 mm	45 mm	135 mm	KK 100/01
52 mm	62 mm	175 mm	KK 100/02
84 mm	65 mm	175 mm	KK 100/03
31 mm	31 mm	100 mm	KK 102/30
15 mm	15 mm	75 mm	KK 104/00



Rippensperrer
Rib Spreaders
Separadores costales
Ecarteurs des côtes
Divaricatori costali

ALUMINIUM

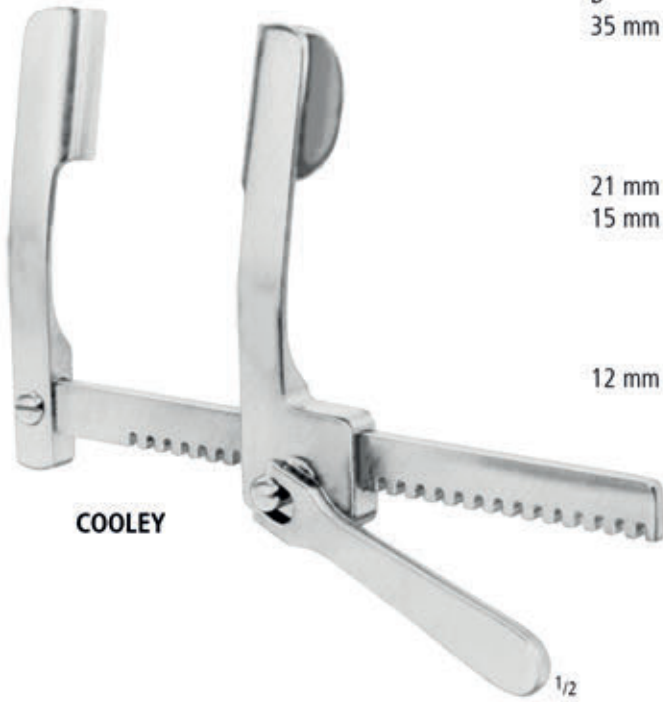

COOLEY

B	H	C	
35 mm	50 mm	200 mm	KK 106/01

21 mm	44 mm	150 mm	KK 106/02
15 mm	30 mm	140 mm	KK 106/03

12 mm	16 mm	95 mm	KK 106/04
-------	-------	-------	-----------

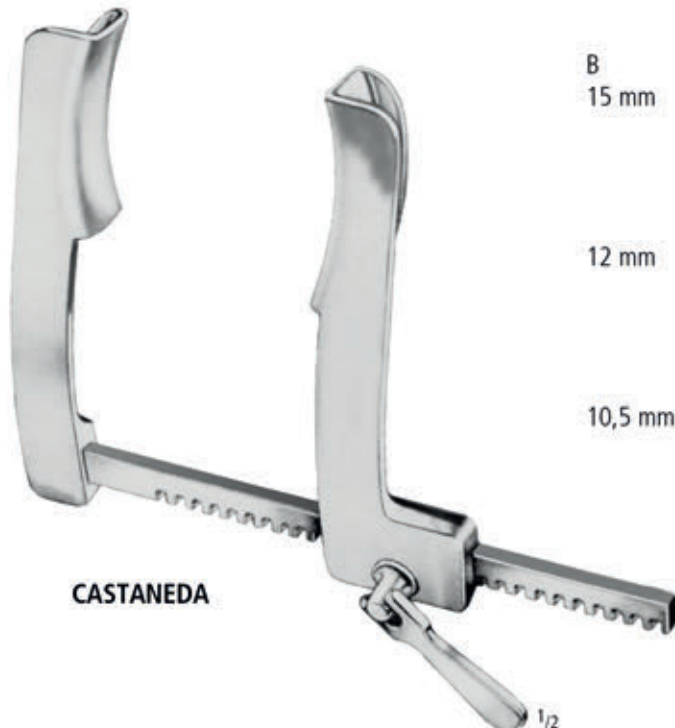

CASTANEDA

B	H	C	
15 mm	60 mm	120 mm	KK 110/01

12 mm	45 mm	70 mm	KK 110/02
-------	-------	-------	-----------

10,5 mm	32 mm	65 mm	KK 110/03
---------	-------	-------	-----------



AA
AB
AC
AD
AE
AF
AK
AL
AO
KA
KK
X

Rippensperrer
 Rib Spreaders
 Separadores costales
 Ecarteurs des côtes
 Divaricatori costali

ALUMINIUM



mit 2 Paar Valven
 with 2 pairs of blades
 con 2 pares de valvas
 avec 2 paires des valves
 con 2 paia di valve

BURFORD

B	H	C	
65 mm	62 mm		
47 mm	62 mm	200 mm	KK 120/01
65 mm	62 mm		
47 mm	62 mm	250 mm	KK 120/02
65 mm	62 mm		
47 mm	62 mm	300 mm	KK 120/03
48 mm	42 mm		
34 mm	42 mm	135 mm	KK 120/04



Spatel
Spatulas
Espátulas
Spatules
Spatole



KK 150/18
18,5 cm/7 1/4"

KK 150/21
21,5 cm/8 1/2"

KK 152/23
23,0 cm/9"



DAVIS
KK 153/24
24,5 cm/9 3/4"

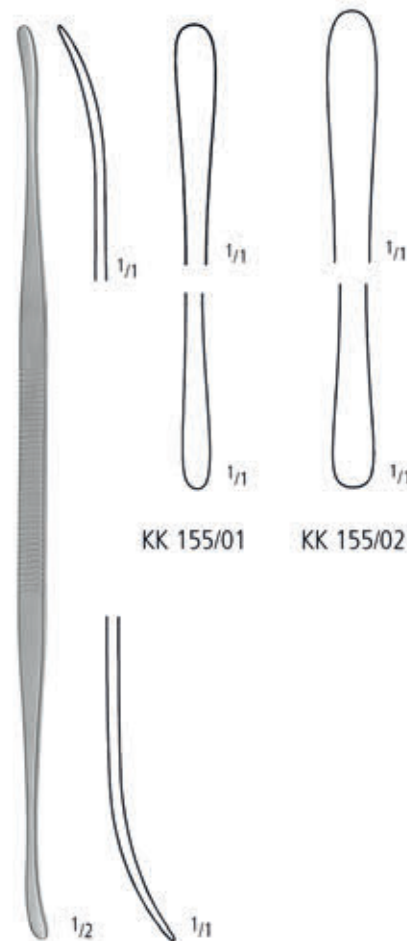

TÖNNIS
24,0 cm/9 1/2"

KK 155/01

KK 155/02



SCHMID



KK 156/01
14,0 cm/5 1/2"



KK 156/02
23,5 cm/9 1/4"



PENFIELD
KS 638/01
17,5 cm/7"

AA
AB
AC
AD
AE
AF
AK
AL
AO
KA
KK
X

Feine Wundhaken
 Delicate Hooks
 Ganchos
 Crochets très fins
 Divaricatori sottili

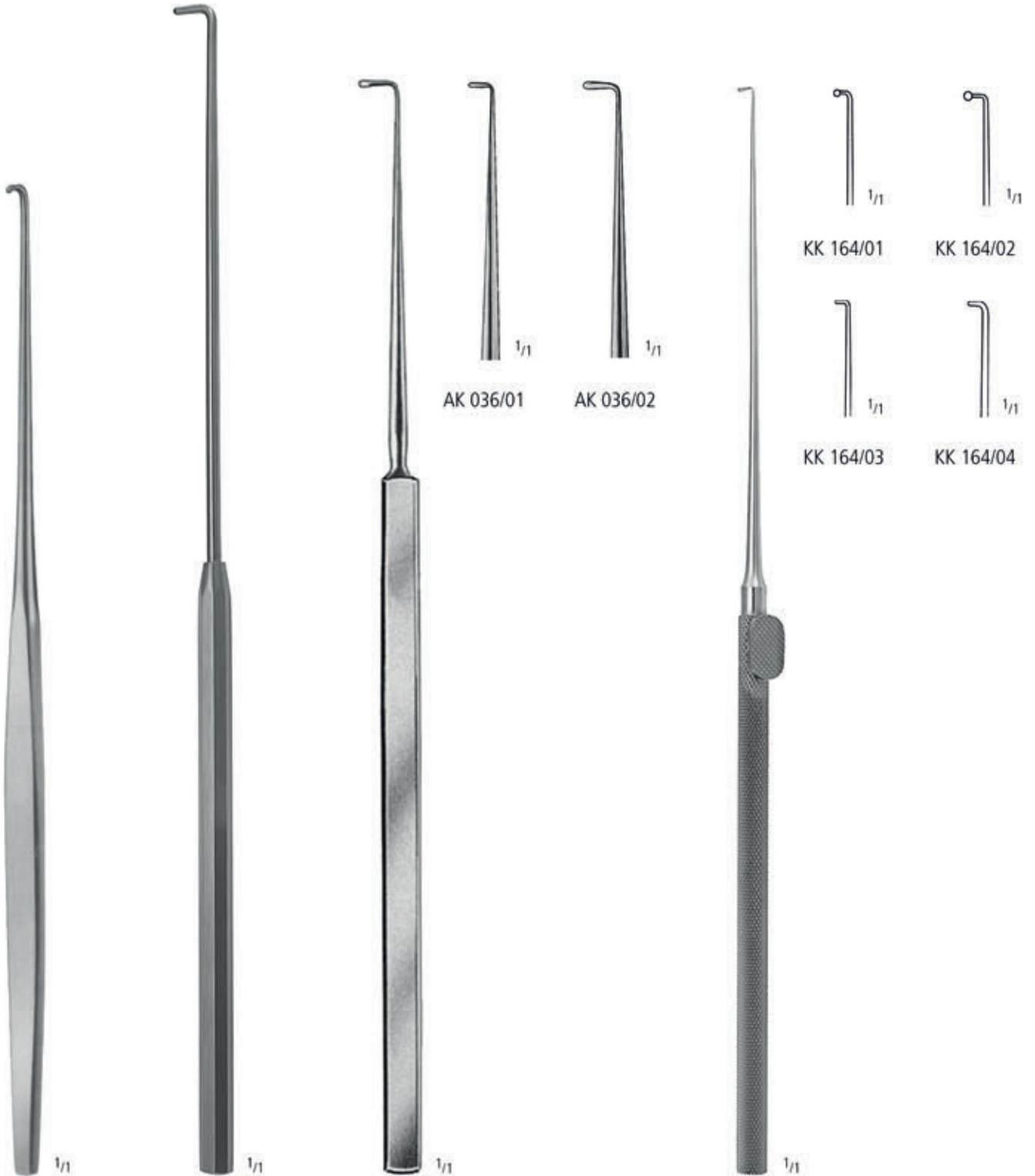

BROM
 KK 160/17
 17,0 cm/6³/₄"

CRILE
 KK 162/20
 20,0 cm/8"

CUSHING
 19,0 cm/7¹/₂"

KRAYENBÜHL
 18,5 cm/7¹/₄"

Feine Wundhaken
 Delicate Hooks
 Ganchos
 Crochets très fins
 Divaricatori sottili

AA
 AB
 AC
 AD
 AE
 AF
 AK
 AL
 AO
 KA
KK
 X



BIEMER
 KK 165/16
 16,0 cm/6 1/4"



FISCH
 KK 166/01
 18,5 cm/7 1/4"



KK 166/02



GILLIES
 AK 020/01
 18,0 cm/7"

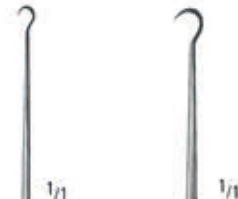

AK 020/02



KILNER
 AK 022/15
 15,0 cm/6"

Rippenkonraktoren
 Rib contractors
 Aproximadores para costillas
 Rapprocheurs des côtes
 Approssimatori costali



SELLORS
 KK 170/19
 19,0 cm/7¹/₂"



BAILEY-BABY
 KK 172/14
 14,0 cm/5¹/₂"

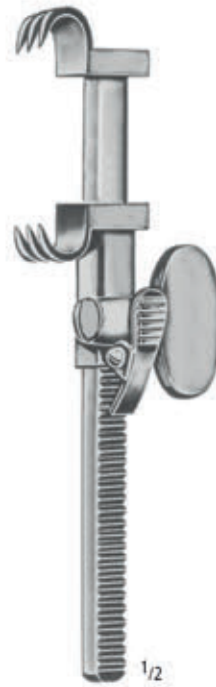

BAILEY
 KK 174/16
 16,0 cm/6¹/₄"

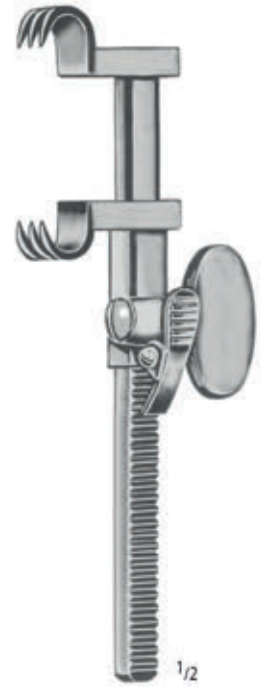

BAILEY-GIBBON
 KK 176/16
 16,0 cm/6¹/₄"

Lungenspatel
 Lung Spatulas
 Espátulas pulmonares
 Spatules pulmonaires
 Spatole per polmone

**ALLISON**

KK 180/26	KK 180/32
26,0 cm/10 ¹ / ₄ "	32,0 cm/12 ¹ / ₂ "

AA

AB

AC

AD

AE

AF

AK

AL

AO

KA

KK

X

Atriumhaken
Atrium retractor
Separadores auriculares
Ecarteurs à atrium
Divaricatori atriali



COOLEY-STRUCK
KK 188/01
24,0 cm/9¹/₂"

COOLEY-STRUCK
KK 188/02
24,0 cm/9¹/₂"

COOLEY
KK 190/01
24,5 cm/9³/₄"

COOLEY
KK 190/02
24,5 cm/9³/₄"

COOLEY
KK 190/03
25,5 cm/10"

Clips
Clips
Clips
Clips
Clips

AA

AB

AC

AD

AE

AF

AK

AL

AO

KA

KK

X



L	KK 300/01	KK 300/02	KK 300/03	KK 300/04	KK 300/05	KK 300/06	KK 300/07	
W	4 mm	6 mm	8 mm	10 mm	6 mm	6 mm	6 mm	
F	0,75 mm	1 mm	2 mm	2 mm	1 mm	1 mm	1 mm	
	125 gr	100 gr	85 gr	60 gr	85 gr	85 gr	85 gr	

F
Schließkraft
Closing force
Presión
Pression
Pressione



KK 302/14
14,0 cm/5 1/2"



KK 303/18
18,0 cm/7"

Clips
Clips
Clips
Clips
Clips



BIEMER

	KK 306/01	KK 306/02	KK 306/03
L	6 mm	9 mm	9 mm
W	4 mm	5 mm	5 mm
F	30-40 gr	30-40 gr	20-25 gr



KK 308/01
14,5 cm/5³/₄"



KK 308/02
14,5 cm/5³/₄"

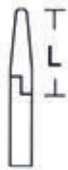

F
Schließkraft
Closing force
Presión
Pression
Pressione

W
Maulöffnung
Opening
Abertura
Overture
Apertura

MEHDORN



	KK 310/01
L	4 mm
W	1,0 mm
F	10-15 gr



	KK 310/02
L	4 mm
W	1,4 mm
F	15-20 gr



	KK 310/03
L	6 mm
W	1,0 mm
F	10-15 gr



	KK 310/04
L	6 mm
W	1,4 mm
F	15-20 gr

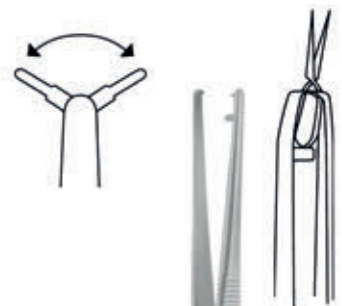

KK 312/15
15,0 cm/6"

Clips
Clips
Clips
Clips
Clips

AA
AB
AC
AD
AE
AF
AK
AL
AO
KA
KK
X



1/1

MÜLLER

F = 50gr
F = 80gr



1/1

KK 314/50
KK 314/80



1/1

KK 315/50
KK 315/80



1/1

KK 316/50
KK 316/80



1/1

KK 317/50
KK 317/80



1/1

KK 318/50
KK 318/80

F
Schließkraft
Closing force
Presión
Pression
Pressione



1/1

DE BAKEY-HESS
KK 320/01



1/1

DE BAKEY-HESS
KK 320/02

Atrauma Bulldogklemmen
 Atrauma Bulldog Clamps
 Atrauma Clamps Bulldog
 Clamps Atrauma Bulldog
 Pinze Atrauma Bulldog



DE BAKEY



DE BAKEY



KK 350/07
7,5 cm/3"



KK 350/08
8,5 cm/3 1/2"



KK 350/10
10,5 cm/4 1/4"



KK 350/12
12,0 cm/4 3/4"



DE BAKEY



KK 351/07
7,0 cm/2 3/4"



KK 351/08
8,0 cm/3 1/4"



KK 351/10
10,0 cm/4"



KK 351/12
11,5 cm/4 1/2"

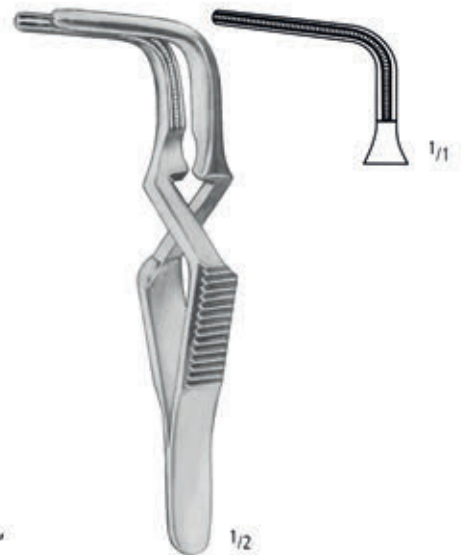

SANTULLI
 KK 357/07
 7,0 cm/2 3/4"

Atrauma Bulldogklemmen
 Atrauma Bulldog Clamps
 Atrauma Clamps Bulldog
 Clamps Atrauma Bulldog
 Pinze Atrauma Bulldog



DE BAKEY



GLOVER



KK 370/06
6,0 cm/2 1/2"



KK 370/07
7,5 cm/2 3/4"



KK 370/09
9,0 cm/3 1/2"



KK 370/11
11,0 cm/4 1/2"



GLOVER



KK 371/06
5,5 cm/2 1/4"



KK 371/07
6,5 cm/2 1/2"



KK 371/09
8,5 cm/3 1/3"



KK 371/11
10,5 cm/4 1/4"



GLOVER
KK 372/05
5,0 cm/2"

AA
AB
AC
AD
AE
AF
AK
AL
AO
KA
KK
X

Atrauma Bulldogklemmen
 Atrauma Bulldog Clamps
 Atrauma Clamps Bulldog
 Clamps Atrauma Bulldog
 Pinze Atrauma Bulldog



DE BAKEY



DE BAKEY-SATINSKY
 KK 373/07
 7,0 cm/2³/₄"



DE BAKEY-CAROTIS
 KK 373/09
 9,0 cm/3¹/₂"



DE BAKEY-SATINSKY
 KK 373/10
 10,0 cm/4"

Atrauma Bulldogklemmen
 Atrauma Bulldog Clamps
 Atrauma Clamps Bulldog
 Clamps Atrauma Bulldog
 Pinze Atrauma Bulldog



DE BAKEY



GREGORY-SOFT



KK 375/01
 9,0 cm/3 1/2"



KK 375/02
 11,0 cm/4 1/2"



KK 375/03
 11,0 cm/4 1/2"



KK 375/04
 11,0 cm/4 1/2"

AA
 AB
 AC
 AD
 AE
 AF
 AK
 AL
 AO
 KA
 KK
 X

Atrauma-Klemmen
 Atrauma Forceps
 Pinzas Atrauma
 Pincès atraumatiques
 Pinze Atrauma



DE BAKEY

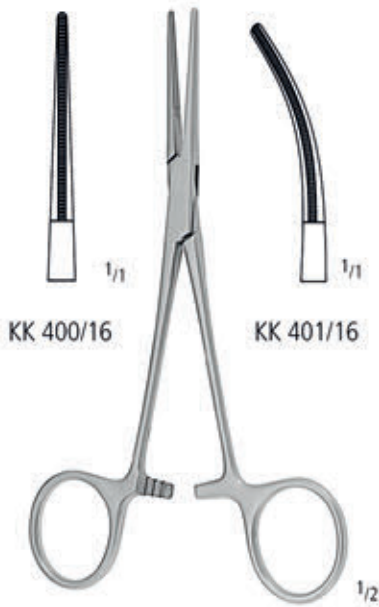

DE BAKEY-RANKIN
 16,0 cm/6¹/₄"

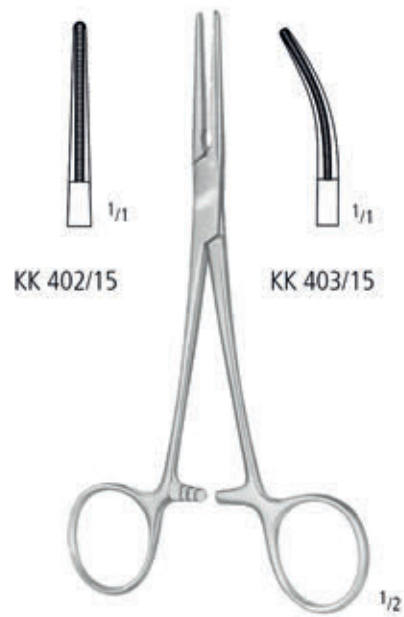

DE BAKEY-MOSQUITO
 15,0 cm/6"

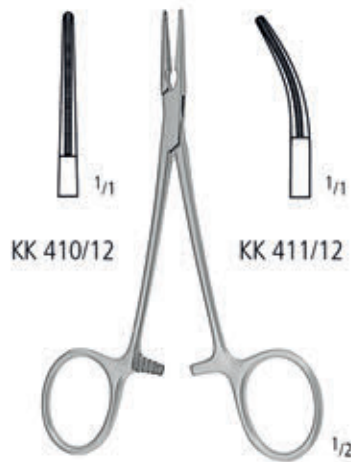

DE BAKEY-MOSQUITO
 12,0 cm/4³/₄"

Atrauma-Klemmen
 Atrauma Forceps
 Pinzas Atrauma
 Pincas atraumatiques
 Pinze Atrauma



DE BAKEY



DE BAKEY-PEAN



KK 414/14
 14,0 cm/5 1/2"



KK 414/16
 16,0 cm/6 1/4"



KK 414/18
 18,0 cm/7"



KK 414/20
 20,0 cm/8"



KK 415/14
 14,0 cm/5 1/2"



KK 415/16
 16,0 cm/6 1/4"



KK 415/18
 18,0 cm/7"



KK 415/20
 20,0 cm/8"

AA
 AB
 AC
 AD
 AE
 AF
 AK
 AL
 AO
 KA
 KK
 X

Atrauma-Klemmen
 Atrauma Forceps
 Pinzas Atrauma
 Pincès atraumatiques
 Pinze Atrauma



DE BAKEY

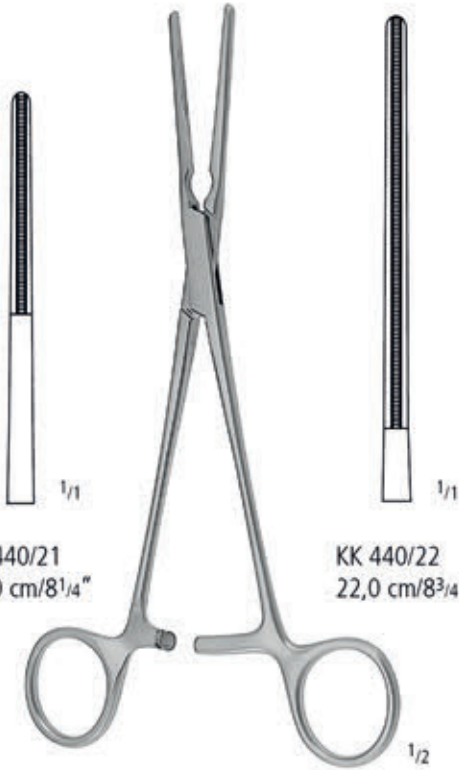

KK 440/21
 21,0 cm/8¹/₄"

KK 440/22
 22,0 cm/8³/₄"

POTTS



KK 441/21
 21,0 cm/8¹/₄"

KK 441/22
 22,0 cm/8³/₄"

POTTS



KK 443/21
 21,0 cm/8¹/₄"

KK 443/22
 22,0 cm/8³/₄"

POTTS



KK 445/22

KK 447/22

POTTS
 22,0 cm/8³/₄"

Atrauma-Klemmen
 Atrauma Forceps
 Pinzas Atrauma
 Pincas atraumatiques
 Pinze Atrauma

ATRAU
 nopa®



DE BAKEY



KK 449/19
 19,0 cm/7 1/2"

KK 449/23
 23,0 cm/9"



DE BAKEY
 KK 451/16
 16,0 cm/6 1/4"



DE BAKEY



KK 453/19
 19,0 cm/7 1/2"

KK 453/20
 20,0 cm/8"



DE BAKEY
 KK 455/20
 20,0 cm/8"

AA
 AB
 AC
 AD
 AE
 AF
 AK
 AL
 AO
 KA
KK
 X

Atrauma-Klemmen
 Atrauma Forceps
 Pinzas Atrauma
 Pincas atraumatiques
 Pinze Atrauma



DE BAKEY

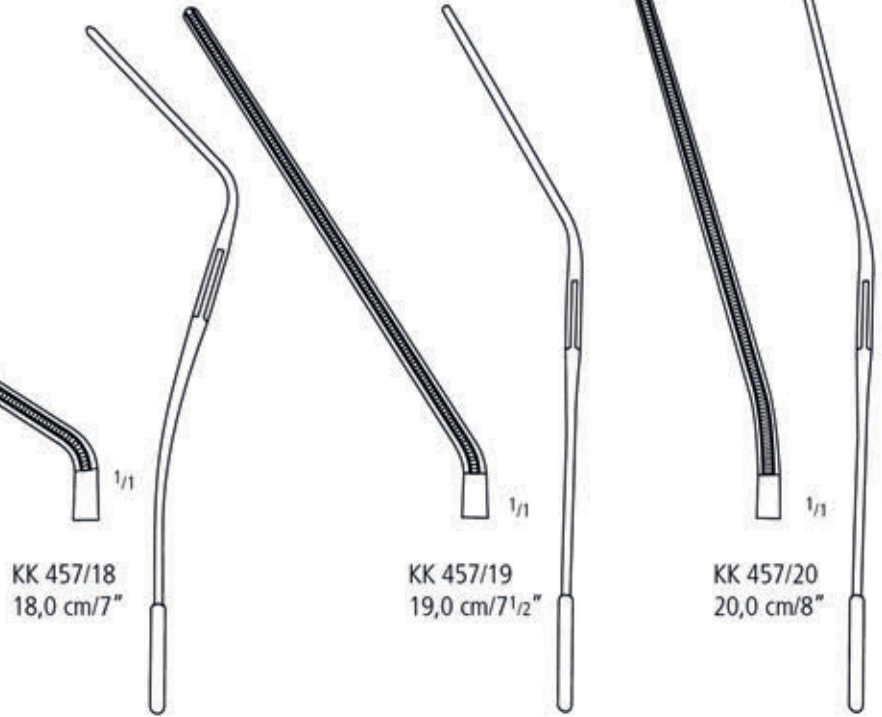

KK 457/18
 18,0 cm/7"

KK 457/19
 19,0 cm/7 1/2"

KK 457/20
 20,0 cm/8"

LELAND-JONES



KK 460/15
 15,0 cm/6"

KK 460/18
 18,0 cm/7"

KK 461/15
 15,0 cm/6"

KK 461/18
 18,0 cm/7"

BAINBRIDGE

Atrauma-Klemmen
 Atrauma Forceps
 Pinzas Atrauma
 Pincas atraumatiques
 Pinze Atrauma



DE BAKEY



DE BAKEY

1/2 KK 469/26
 26,0 cm/10¹/₄"

1/1 KK 469/27
 27,0 cm/10¹/₂"

1/1 KK 469/31
 31,0 cm/12¹/₄"

1/1 KK 469/33
 33,0 cm/13"

AA
 AB
 AC
 AD
 AE
 AF
 AK
 AL
 AO
 KA
 KK
 X

Atrauma-Klemmen
 Atrauma Forceps
 Pinzas Atrauma
 Pincès atraumatiques
 Pinze Atrauma



DE BAKEY



DE BAKEY



KK 473/25
 25,0 cm/10"

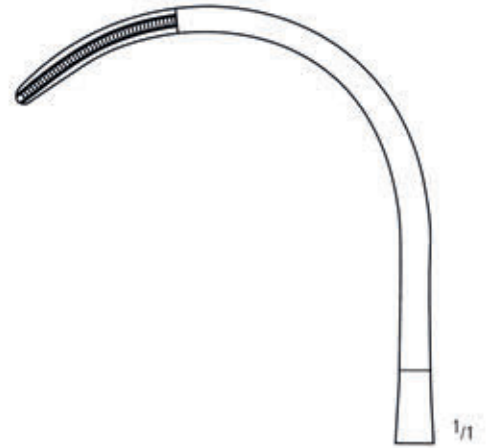

KK 475/26
 26,0 cm/10 1/2"



DE BAKEY



KK 477/24
 24,0 cm/9 1/2"

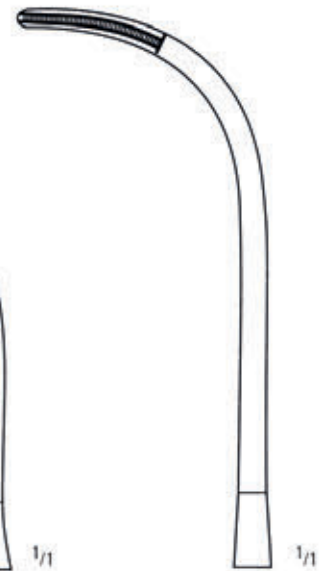

KK 479/24
 24,0 cm/9 1/2"

Atrauma-Klemmen
 Atrauma Forceps
 Pinzas Atrauma
 Pincas atraumatiques
 Pinze Atrauma



DE BAKEY

AA
 AB
 AC
 AD
 AE
 AF
 AK
 AL
 AO
 KA
 KK
 X



DE BAKEY
 KK 481/30
 30,0 cm/11³/₄"

DE BAKEY
 KK 483/28
 28,0 cm/11"

Atrauma-Klemmen
 Atrauma Forceps
 Pinzas Atrauma
 Pincès atraumatiques
 Pinze Atrauma



DE BAKEY



DE BAKEY



KK 486/21
 21,0 cm/8¹/₂"



KK 486/23
 23,0 cm/9"



KK 486/27
 27,0 cm/10¹/₂"



KK 486/31
 31,0 cm/12¹/₂"



DE BAKEY

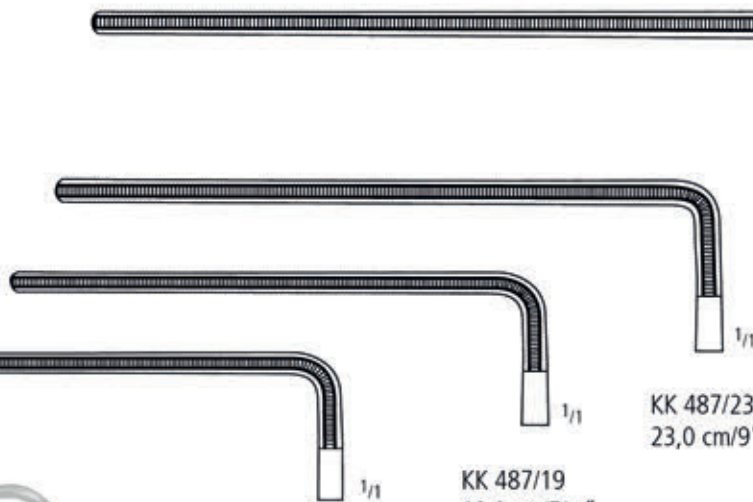

KK 487/18
 18,0 cm/7"

KK 487/19
 19,0 cm/7¹/₂"

KK 487/23
 23,0 cm/9"

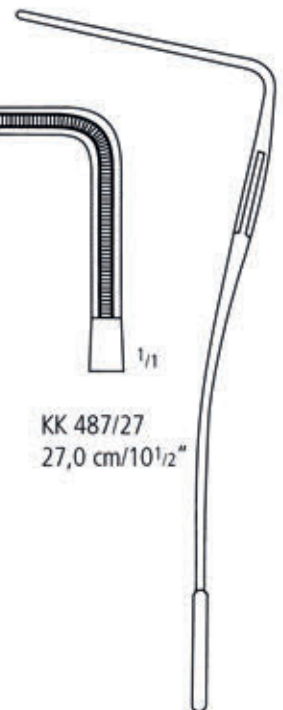

KK 487/27
 27,0 cm/10¹/₂"

Atrauma-Klemmen
 Atrauma Forceps
 Pinzas Atrauma
 Pincas atraumatiques
 Pinze Atrauma

ATRAU
 nopa[®]



DE BAKEY



DE BAKEY



KK 489/20
 20,0 cm/8"

KK 489/21
 21,0 cm/8¹/₄"

KK 489/25
 25,0 cm/10"

KK 489/29
 29,0 cm/11³/₄"



DE BAKEY



KK 491/21
 21,5 cm/8¹/₂"

KK 491/23
 23,0 cm/9"

KK 491/27
 27,0 cm/10¹/₂"

KK 491/31
 31,0 cm/12¹/₂"

AA
 AB
 AC
 AD
 AE
 AF
 AK
 AL
 AO
 KA
 KK
 X

Atrauma-Klemmen
 Atrauma Forceps
 Pinzas Atrauma
 Pincès atraumatiques
 Pinze Atrauma



DE BAKEY

ATRAU
 nopa®

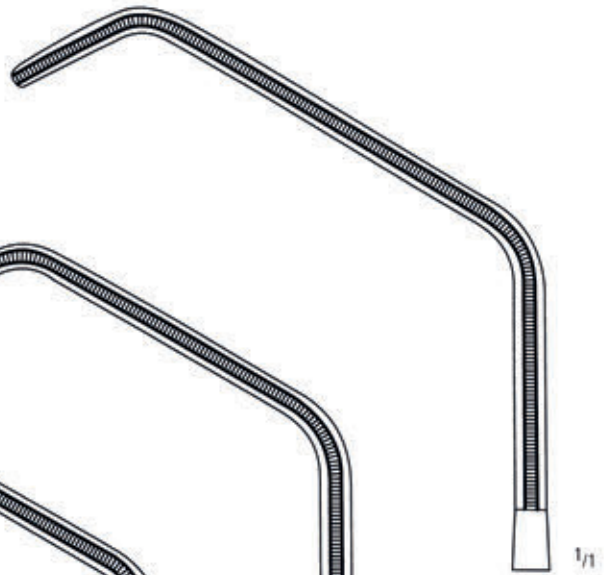

KK 493/27
 27,5 cm/10³/₄"

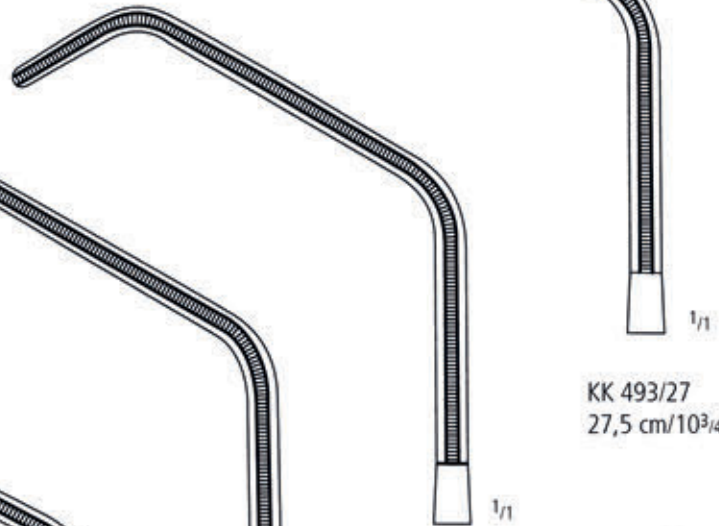

KK 493/26
 26,5 cm/10¹/₂"

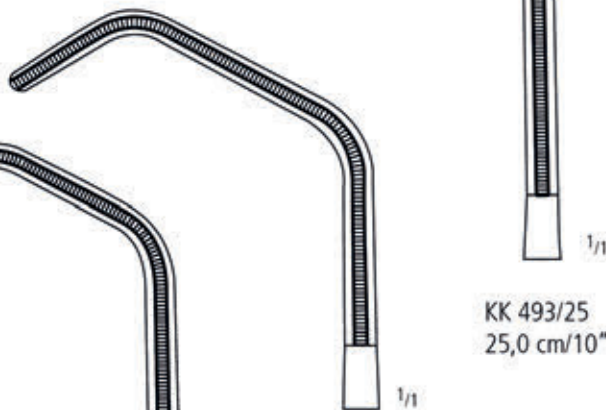

KK 493/25
 25,0 cm/10"

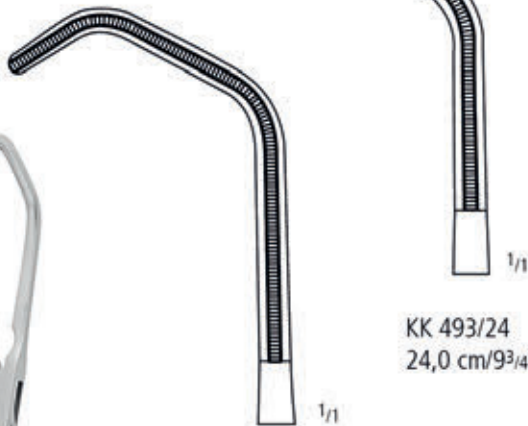

KK 493/24
 24,0 cm/9³/₄"

KK 493/20
 20,5 cm/8"



SATINSKY



Atrauma-Klemmen
 Atrauma Forceps
 Pinzas Atrauma
 Pincès atraumatiques
 Pinze Atrauma

ATRAU
 nopa®



DE BAKY



LAMBERT-KAY



KK 495/01
 21,0 cm/8 1/2"

1/1

1/2

1/1

1/2

1/1

1/2

1/1

1/2

1/1

1/2

1/1

1/2

1/1

1/2

1/1

1/2

1/1

1/2

1/1

1/2

1/1

1/2

1/1

1/2

1/1

1/2

1/1

1/2

1/1

1/2

1/1

1/2

1/1

1/2

1/1

1/2

1/1

1/2

1/1

1/2

1/1

1/2

1/1

1/2

1/1

1/2

1/1

1/2

1/1

1/2

1/1

1/2

1/1

1/2

1/1

1/2

1/1

1/2

1/1

1/2

1/1

1/2

1/1

1/2

1/1

1/2

1/1

1/2

1/1

1/2

1/1

1/2

1/1

1/2

1/1

1/2

1/1

1/2

1/1

1/2

1/1

1/2

1/1

1/2

1/1

1/2

1/1

1/2

1/1

1/2

1/1

1/2

1/1

1/2

1/1

1/2

1/1

1/2

1/1

1/2

1/1

1/2

1/1

1/2

1/1

1/2

1/1

1/2

1/1

1/2

1/1

1/2

1/1

1/2

1/1

1/2

1/1

1/2

1/1

1/2

1/1

1/2

1/1

1/2

1/1

1/2

1/1

1/2

1/1

1/2

1/1

1/2

1/1

1/2

1/1

1/2

1/1

1/2

1/1

1/2

1/1

1/2

1/1

1/2

1/1

1/2

1/1

1/2

1/1

1/2

1/1

1/2

1/1

1/2

1/1

1/2

1/1

1/2

1/1

1/2

1/1

1/2

1/1

1/2

1/1

1/2

1/1

1/2

1/1

1/2

1/1

1/2

1/1

1/2

1/1

1/2

1/1

1/2

1/1

1/2

1/1

1/2

1/1

1/2

1/1

1/2

1/1

1/2

1/1

1/2

1/1

1/2

1/1

1/2

1/1

1/2

1/1

1/2

1/1

1/2

1/1

1/2

1/1

1/2

1/1

1/2

1/1

1/2

1/1

1/2

1/1

1/2

1/1

1/2

1/1

1/2

1/1

1/2

1/1

1/2

1/1

1/2

1/1

1/2

1/1

1/2

1/1

1/2

1/1

1/2

1/1

1/2

1/1

1/2

1/1

1/2



DE BAKY
 KK 501/17
 17,0 cm/6 3/4"



DE BAKY-BAHNSON

KK 503/23
 23,0 cm/9"

1/1

1/2

1/1

1/2

KK 503/24
 24,0 cm/9 1/2"

1/1

1/2

1/1

1/2

KK 503/25
 25,0 cm/10"

1/1

1/2

1/1

1/2

AA
 AB
 AC
 AD
 AE
 AF
 AK
 AL
 AO
 KA
 KK
 X

Atrauma-Klemmen
 Atrauma Forceps
 Pinzas Atrauma
 Pincès atraumatiques
 Pinze Atrauma



DE BAKEY



HARKEN

1/2



KK 505/01
 24,0 cm/9 1/2"

1/1



KK 505/02
 24,0 cm/9 1/2"

1/1



KK 505/03
 24,0 cm/9 1/2"

1/1



KK 505/04
 24,0 cm/9 1/2"

1/1

Atrauma-Klemmen
 Atrauma Forceps
 Pinzas Atrauma
 Pincès atraumatiques
 Pinze Atrauma



DE BAKEY



WEBER
 KK 509/01
 26,0 cm/10¹/₄"



WEBER
 KK 509/02
 26,0 cm/10¹/₄"

AA
 AB
 AC
 AD
 AE
 AF
 AK
 AL
 AO
 KA
 KK
 X

KK

Atrauma-Klemmen
 Atrauma Forceps
 Pinzas Atrauma
 Pincès atraumatiques
 Pinze Atrauma



DE BAKEY

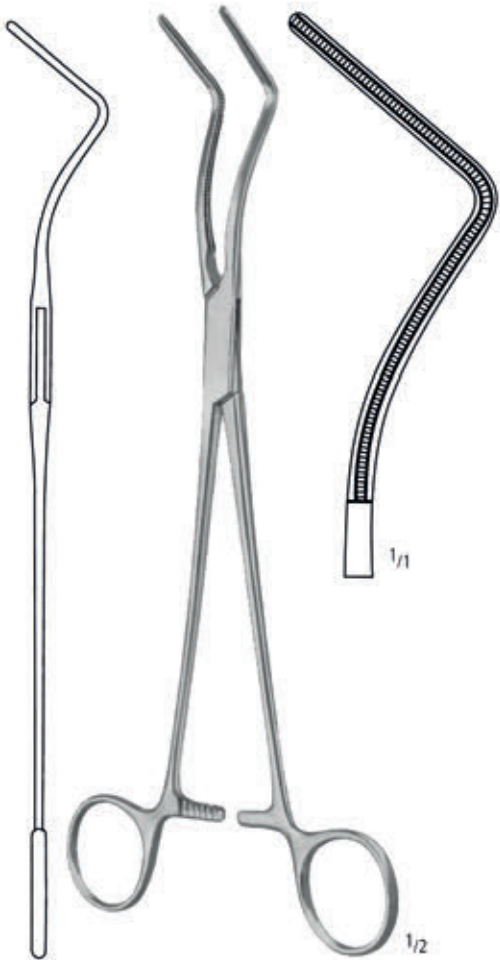

LEES
 KK 511/25
 25,0 cm/10"



LEES



KK 512/23
 23,0 cm/9"



KK 512/25
 25,0 cm/10"

Atrauma-Klemmen
 Atrauma Forceps
 Pinzas Atrauma
 Pincas atraumatiques
 Pinze Atrauma



DE BAKEY

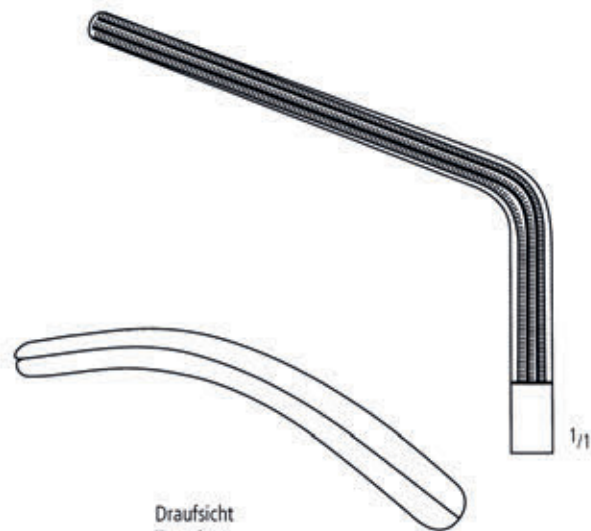

Draufsicht
 Top view
 Vista de arriba
 Vue en plau
 Vista da sopra

DE BAKEY
 KK 513/27
 27,0 cm/10¹/₂"

AA
 AB
 AC
 AD
 AE
 AF
 AK
 AL
 AO
 KA
 KK
 X

Atrauma-Klemmen
 Atrauma Forceps
 Pinzas Atrauma
 Pincès atraumatiques
 Pinze Atrauma



DE BAKEY

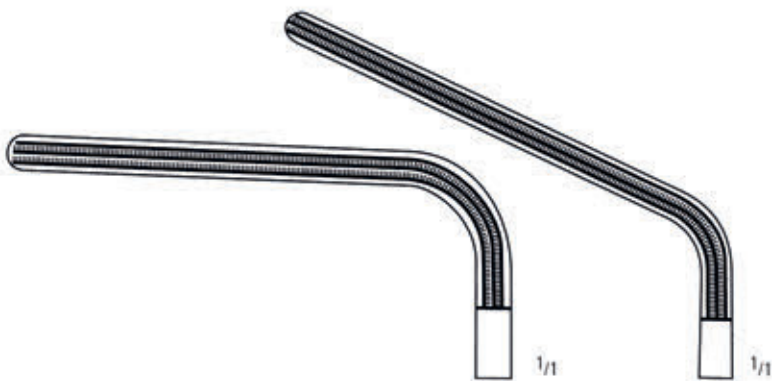

KK 515/18
 18,0 cm/7"

KK 515/20
 20,0 cm/8"



KK 515/23
 23,0 cm/9"

KK 515/25
 25,0 cm/10"



MORRIS-DE BAKEY

Atrauma-Klemmen
 Atrauma Forceps
 Pinzas Atrauma
 Pincas atraumatiques
 Pinze Atrauma

ATRAU
 nopa[®]



DE BAKEY



OCHSNER
 KK 517/23
 23,5 cm/9¹/₄"

1/2



DIETRICH
 KK 519/21
 21,0 cm/8¹/₄"

1/2



GREGORY

1/2



1/1

KK 521/14
 14,0 cm/5¹/₂"



1/1

KK 521/16
 16,0 cm/6¹/₄"



1/1

KK 521/18
 18,0 cm/7"

AA

AB

AC

AD

AE

AF

AK

AL

AO

KA

KK

X

Atrauma-Klemmen
 Atrauma Forceps
 Pinzas Atrauma
 Pincès atraumatiques
 Pinze Atrauma



DE BAKEY



1/2



1/1

KK 523/17
 17,0 cm/6 1/2"



1/1

KK 523/18
 18,0 cm/7"



1/1

KK 523/19
 18,5 cm/7 1/4"

DALE

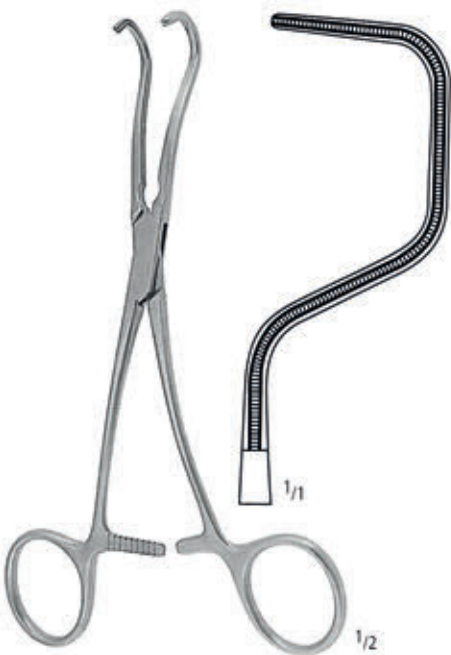

1/2



1/1

DALE
 KK 525/18
 18,5 cm/7"



1/2

DERRA



1/1

KK 527/16
 16,0 cm/6 1/4"



1/1

KK 527/17
 17,0 cm/6 3/4"



1/1

KK 527/18
 18,0 cm/7"

Atrauma-Klemmen
 Atrauma Forceps
 Pinzas Atrauma
 Pincas atraumatiques
 Pinze Atrauma



DE BAKEY



KK 531/16
 16,0 cm/6¹/₄"



KK 531/17
 17,0 cm/6³/₄"



BECK
 KK 535/17
 17,0 cm/6³/₄"



GLOVER
 KK 537/17
 17,0 cm/6³/₄"



KK 539/17
 17,0 cm/6³/₄"

AA
 AB
 AC
 AD
 AE
 AF
 AK
 AL
 AO
 KA
KK
 X

Atrauma-Klemmen
 Atrauma Forceps
 Pinzas Atrauma
 Pincès atraumatiques
 Pinze Atrauma



DE BAKEY



DE BAKEY
 KK 540/17
 17,0 cm/6³/₄"

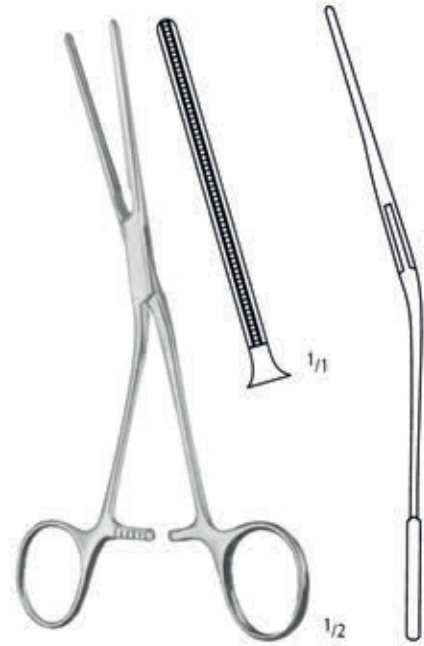

DE BAKEY
 KK 541/17
 17,0 cm/6³/₄"



DE BAKEY
 KK 543/15
 15,0 cm/6"



DE BAKEY
 KK 545/15
 15,0 cm/6"

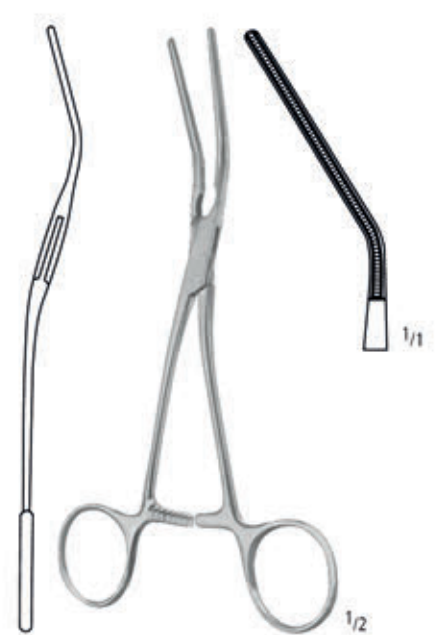

DE BAKEY
 KK 547/16
 16,0 cm/6¹/₄"

Atrauma-Klemmen
 Atrauma Forceps
 Pinzas Atrauma
 Pincas atraumatiques
 Pinze Atrauma

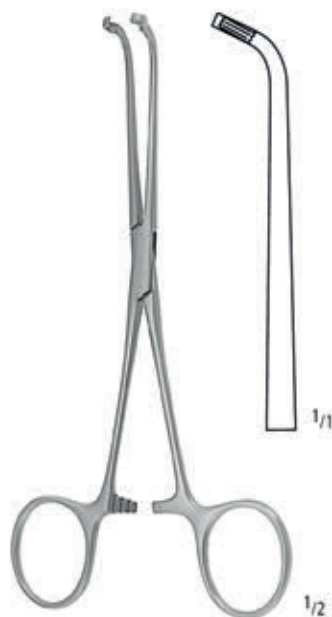

JAVID
 KK 561/18
 18,0 cm/7"



JAVID
 KK 561/19
 19,0 cm/7 1/2"

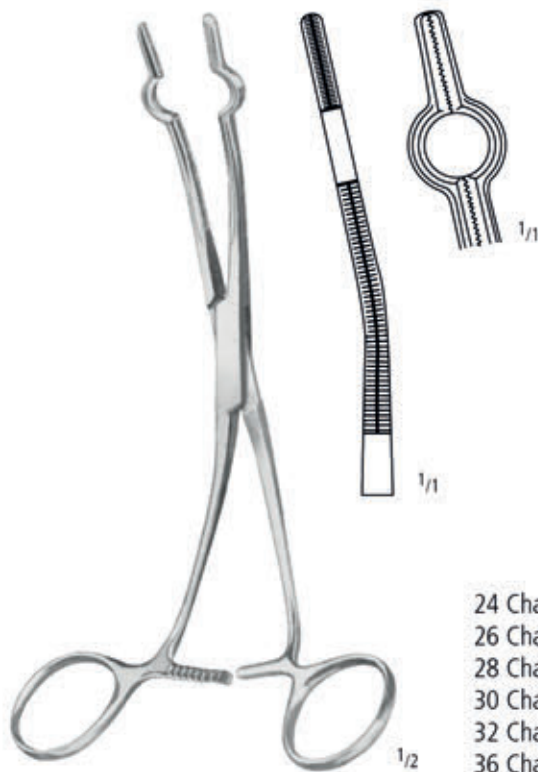

COOLEY

24 Charr.	16,0 cm/6 1/4"	KK 565/24
26 Charr.	16,0 cm/6 1/4"	KK 565/26
28 Charr.	20,0 cm/8"	KK 565/28
30 Charr.	20,0 cm/8"	KK 565/30
32 Charr.	20,0 cm/8"	KK 565/32
36 Charr.	20,0 cm/8"	KK 565/36

AA
 AB
 AC
 AD
 AE
 AF
 AG
 AH
 AI
 AJ
 AK
 AL
 AM
 AN
 AO
 AP
 AQ
 AR
 AS
 AT
 AU
 AV
 AW
 AX
 AY
 AZ
 BA
 BB
 BC
 BD
 BE
 BF
 BG
 BH
 BI
 BJ
 BK
 BL
 BM
 BN
 BO
 BP
 BQ
 BR
 BS
 BT
 BU
 BV
 BW
 BX
 BY
 BZ
 CA
 CB
 CC
 CD
 CE
 CF
 CG
 CH
 CI
 CJ
 CK
 CL
 CM
 CN
 CO
 CP
 CQ
 CR
 CS
 CT
 CU
 CV
 CW
 CX
 CY
 CZ
 DA
 DB
 DC
 DD
 DE
 DF
 DG
 DH
 DI
 DJ
 DK
 DL
 DM
 DN
 DO
 DP
 DQ
 DR
 DS
 DT
 DU
 DV
 DW
 DX
 DY
 DZ
 EA
 EB
 EC
 ED
 EE
 EF
 EG
 EH
 EI
 EJ
 EK
 EL
 EM
 EN
 EO
 EP
 EQ
 ER
 ES
 ET
 EU
 EV
 EW
 EX
 EY
 EZ
 FA
 FB
 FC
 FD
 FE
 FF
 FG
 FH
 FI
 FJ
 FK
 FL
 FM
 FN
 FO
 FP
 FQ
 FR
 FS
 FT
 FU
 FV
 FW
 FX
 FY
 FZ
 GA
 GB
 GC
 GD
 GE
 GF
 GG
 GH
 GI
 GJ
 GK
 GL
 GM
 GN
 GO
 GP
 GQ
 GR
 GS
 GT
 GU
 GV
 GW
 GX
 GY
 GZ
 HA
 HB
 HC
 HD
 HE
 HF
 HG
 HH
 HI
 HJ
 HK
 HL
 HM
 HN
 HO
 HP
 HQ
 HR
 HS
 HT
 HU
 HV
 HW
 HX
 HY
 HZ
 IA
 IB
 IC
 ID
 IE
 IF
 IG
 IH
 II
 IJ
 IK
 IL
 IM
 IN
 IO
 IP
 IQ
 IR
 IS
 IT
 IU
 IV
 IW
 IX
 IY
 IZ
 JA
 JB
 JC
 JD
 JE
 JF
 JG
 JH
 JI
 JJ
 JK
 JL
 JM
 JN
 JO
 JP
 JQ
 JR
 JS
 JT
 JU
 JV
 JW
 JX
 JY
 JZ
 KA
 KB
 KC
 KD
 KE
 KF
 KG
 KH
 KI
 KJ
 KK
 KL
 KM
 KN
 KO
 KP
 KQ
 KR
 KS
 KT
 KU
 KV
 KW
 KX
 KY
 KZ
 LA
 LB
 LC
 LD
 LE
 LF
 LG
 LH
 LI
 LJ
 LK
 LL
 LM
 LN
 LO
 LP
 LQ
 LR
 LS
 LT
 LU
 LV
 LW
 LX
 LY
 LZ
 MA
 MB
 MC
 MD
 ME
 MF
 MG
 MH
 MI
 MJ
 MK
 ML
 MM
 MN
 MO
 MP
 MQ
 MR
 MS
 MT
 MU
 MV
 MW
 MX
 MY
 MZ
 NA
 NB
 NC
 ND
 NE
 NF
 NG
 NH
 NI
 NJ
 NK
 NL
 NM
 NN
 NO
 NP
 NQ
 NR
 NS
 NT
 NU
 NV
 NW
 NX
 NY
 NZ
 OA
 OB
 OC
 OD
 OE
 OF
 OG
 OH
 OI
 OJ
 OK
 OL
 OM
 ON
 OO
 OP
 OQ
 OR
 OS
 OT
 OU
 OV
 OW
 OX
 OY
 OZ
 PA
 PB
 PC
 PD
 PE
 PF
 PG
 PH
 PI
 PJ
 PK
 PL
 PM
 PN
 PO
 PP
 PQ
 PR
 PS
 PT
 PU
 PV
 PW
 PX
 PY
 PZ
 QA
 QB
 QC
 QD
 QE
 QF
 QG
 QH
 QI
 QJ
 QK
 QL
 QM
 QN
 QO
 QP
 QQ
 QR
 QS
 QT
 QU
 QV
 QW
 QX
 QY
 QZ
 RA
 RB
 RC
 RD
 RE
 RF
 RG
 RH
 RI
 RJ
 RK
 RL
 RM
 RN
 RO
 RP
 RQ
 RR
 RS
 RT
 RU
 RV
 RW
 RX
 RY
 RZ
 SA
 SB
 SC
 SD
 SE
 SF
 SG
 SH
 SI
 SJ
 SK
 SL
 SM
 SN
 SO
 SP
 SQ
 SR
 SS
 ST
 SU
 SV
 SW
 SX
 SY
 SZ
 TA
 TB
 TC
 TD
 TE
 TF
 TG
 TH
 TI
 TJ
 TK
 TL
 TM
 TN
 TO
 TP
 TQ
 TR
 TS
 TT
 TU
 TV
 TW
 TX
 TY
 TZ
 UA
 UB
 UC
 UD
 UE
 UF
 UG
 UH
 UI
 UJ
 UK
 UL
 UM
 UN
 UO
 UP
 UQ
 UR
 US
 UT
 UY
 UZ
 VA
 VB
 VC
 VD
 VE
 VF
 VG
 VH
 VI
 VJ
 VK
 VL
 VM
 VN
 VO
 VP
 VQ
 VR
 VS
 VT
 VU
 VV
 VW
 VX
 VY
 VZ
 WA
 WB
 WC
 WD
 WE
 WF
 WG
 WH
 WI
 WJ
 WK
 WL
 WM
 WN
 WO
 WP
 WQ
 WR
 WS
 WT
 WU
 WV
 WW
 WX
 WY
 WZ
 XA
 XB
 XC
 XD
 XE
 XF
 XG
 XH
 XI
 XJ
 XK
 XL
 XM
 XN
 XO
 XP
 XQ
 XR
 XS
 XT
 XU
 XV
 XW
 XX
 XY
 XZ
 YA
 YB
 YC
 YD
 YE
 YF
 YG
 YH
 YI
 YJ
 YK
 YL
 YM
 YN
 YO
 YP
 YQ
 YR
 YS
 YT
 YU
 YV
 YW
 YX
 YZ
 ZA
 ZB
 ZC
 ZD
 ZE
 ZF
 ZG
 ZH
 ZI
 ZJ
 ZK
 ZL
 ZM
 ZN
 ZO
 ZP
 ZQ
 ZR
 ZS
 ZT
 ZU
 ZV
 ZW
 ZX
 ZY
 ZZ

KK

X

Atrauma-Klemmen
 Atrauma Forceps
 Pinzas Atrauma
 Pincès atraumatiques
 Pinze Atrauma



COOLEY



COOLEY
 KK 571/20
 20,0 cm/8"

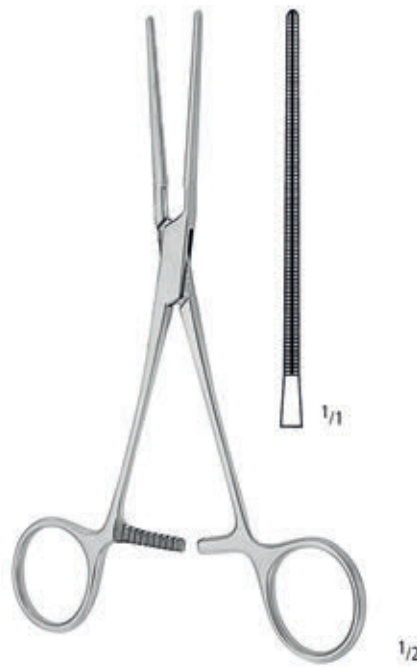

COOLEY
 KK 574/17
 17,0 cm/6³/₄"



COOLEY
 KK 575/17
 17,0 cm/6³/₄"

graduiert - graduated

Atrauma-Klemmen
 Atrauma Forceps
 Pinzas Atrauma
 Pincès atraumatiques
 Pinze Atrauma



COOLEY



COOLEY
 KK 577/17
 17,0 cm/6³/₄"

graduiert - graduated



COOLEY
 KK 579/17
 17,0 cm/6³/₄"

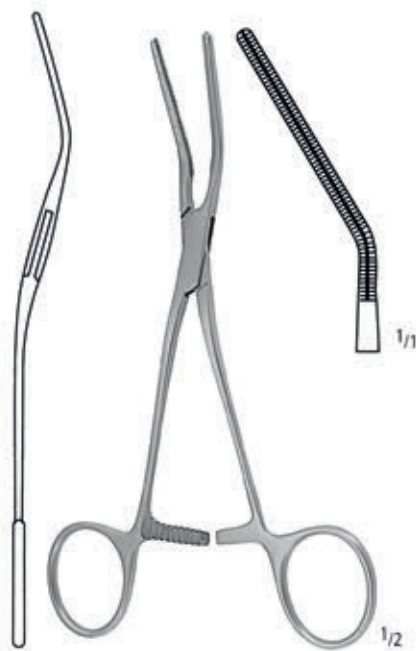

COOLEY
 KK 581/17
 17,0 cm/6³/₄"

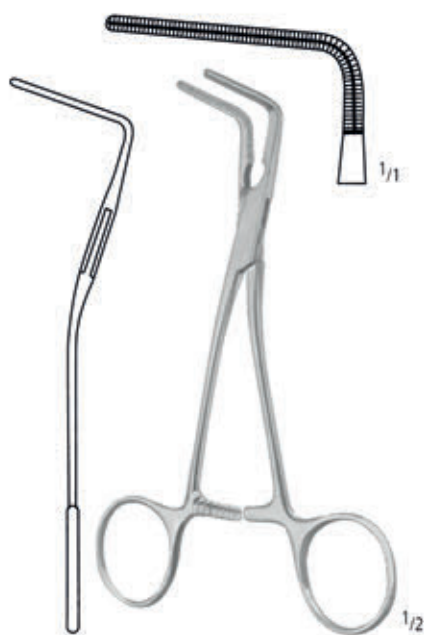

COOLEY
 KK 583/15
 15,0 cm/6"

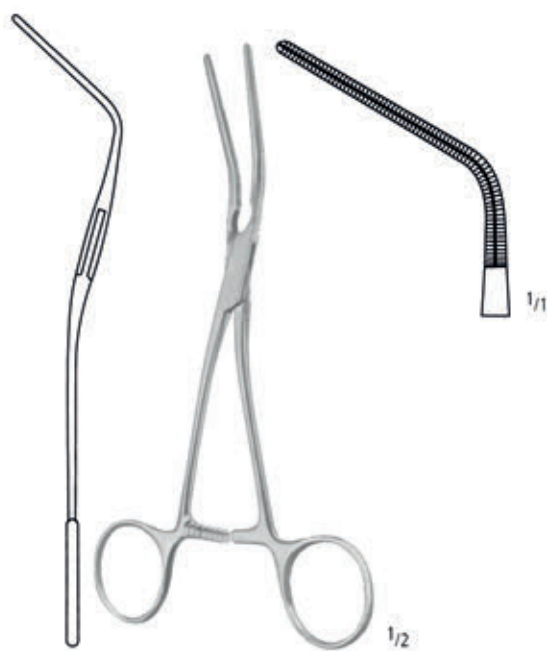

COOLEY
 KK 585/16
 15,5 cm/6¹/₈"

AA

AB

AC

AD

AE

AF

AK

AL

AO

KA

KK

X

Atrauma-Klemmen
 Atrauma Forceps
 Pinzas Atrauma
 Pincès atraumatiques
 Pinze Atrauma



COOLEY

ATRAU
 nopa®



COOLEY



KK 587/16
 16,0 cm/6¹/₄"



KK 587/17
 17,0 cm/6³/₄"



COOLEY
 KK 589/17
 17,0 cm/6³/₄"

graduiert - graduated



COOLEY
 KK 591/16
 16,0 cm/6¹/₄"

Atrauma-Klemmen
 Atrauma Forceps
 Pinzas Atrauma
 Pincas atraumatiques
 Pinze Atrauma

ATRAU
 nopa[®]



COOLEY



COOLEY-DERRA

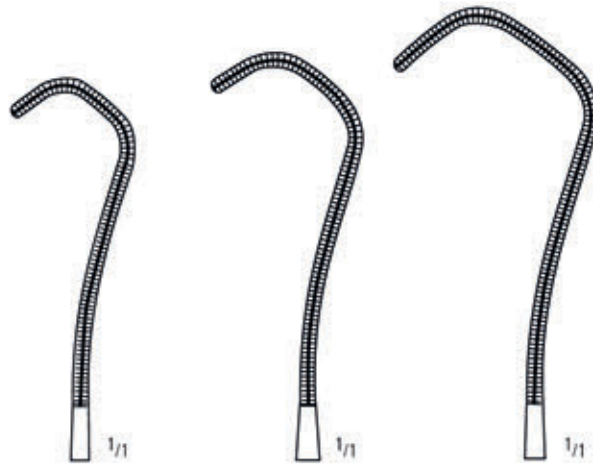

KK 593/16
 16,0 cm/6¹/₄"

KK 593/17
 17,0 cm/6³/₄"

KK 593/18
 18,0 cm/7"

graduiert - graduated



BECK
 KK 595/17
 17,0 cm/6³/₄"

AA
 AB
 AC
 AD
 AE
 AF
 AK
 AL
 AO
 KA
 X
KK

Atrauma-Klemmen
 Atrauma Forceps
 Pinzas Atrauma
 Pincès atraumatiques
 Pinze Atrauma



DARDIK

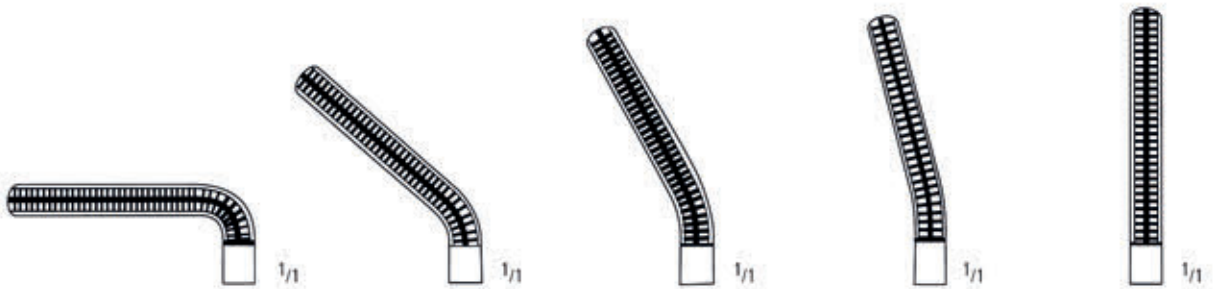

KK 597/01
 13,0 cm/5¹/₄"

KK 597/02
 14,5 cm/5³/₄"

KK 597/03
 15,0 cm/6"

KK 597/04
 15,0 cm/6"

KK 597/05
 15,0 cm/6"



DARDIK

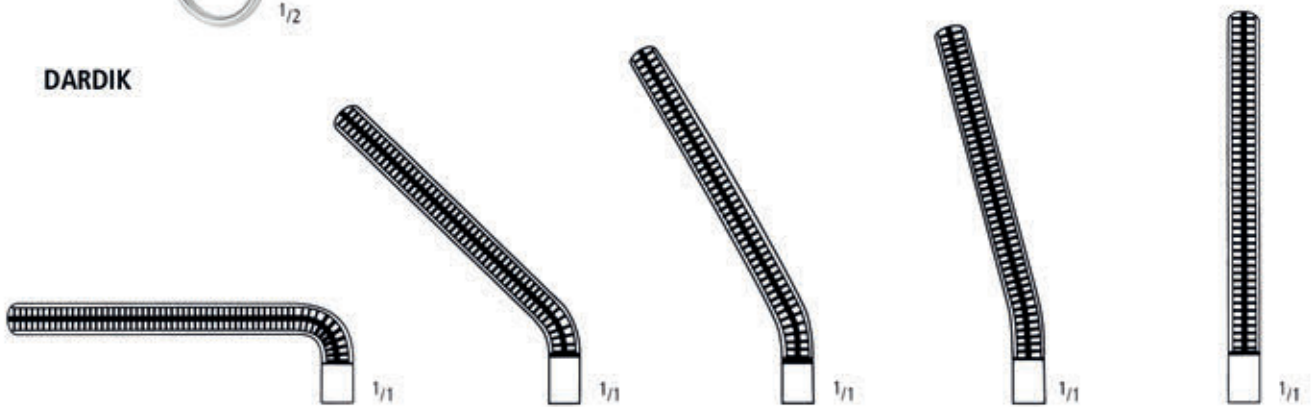

KK 599/01
 13,5 cm/5¹/₂"

KK 599/02
 16,0 cm/6¹/₄"

KK 599/03
 17,0 cm/6³/₄"

KK 599/04
 17,0 cm/6³/₄"

KK 599/05
 17,0 cm/6³/₄"

Atrauma-Klemmen
 Atrauma Forceps
 Pinzas Atrauma
 Pincas atraumatiques
 Pinze Atrauma

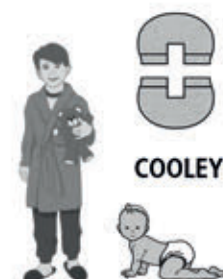

COOLEY

graduiert - graduated



COOLEY
 KK 603/14
 14,0 cm/5 1/2"



COOLEY
 KK 605/14
 14,0 cm/5 1/2"



COOLEY
 KK 607/14
 14,0 cm/5 1/2"

AA
 AB
 AC
 AD
 AE
 AF
 AG
 AH
 AI
 AJ
 AK
 AL
 AM
 AN
 AO
 AP
 AQ
 AR
 AS
 AT
 AU
 AV
 AW
 AX
KK

Atrauma-Klemmen
 Atrauma Forceps
 Pinzas Atrauma
 Pincès atraumatiques
 Pinze Atrauma



KK 611/01
 14,0 cm/5 1/2"



KK 611/02
 14,0 cm/5 1/2"



KK 611/03
 14,0 cm/5 1/2"



KK 611/04
 13,0 cm/5"



KK 611/05
 14,0 cm/5 1/2"



KK 611/06
 13,0 cm/5"



KK 611/07
 13,0 cm/5"



KK 611/08
 14,0 cm/5 1/2"



KK 611/09
 13,5 cm/5 1/4"

Atrauma-Klemmen
 Atrauma Forceps
 Pinzas Atrauma
 Pincès atraumatiques
 Pinze Atrauma



KK 620/16
 16,5 cm/6 1/2"



KK 621/16
 16,0 cm/6 1/4"



KK 623/15
 15,0 cm/6"

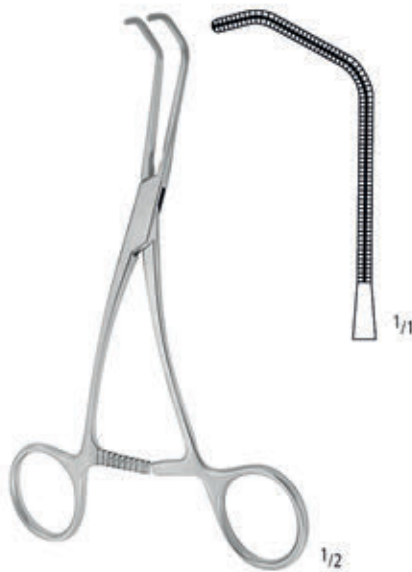

KK 625/15
 15,0 cm/6"

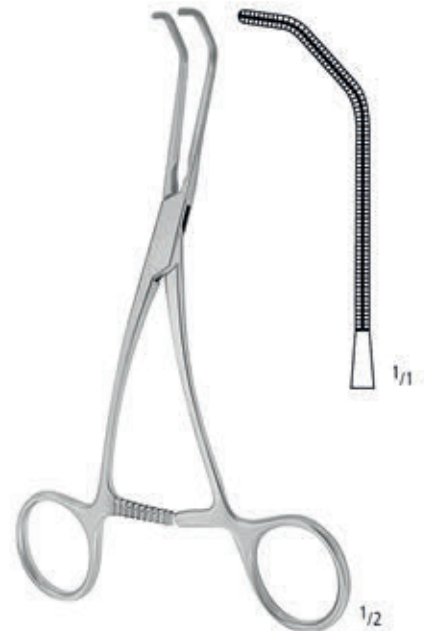

KK 627/15
 15,5 cm/6 1/8"

AA
 AB
 AC
 AD
 AE
 AF
 AK
 AL
 AO
 KA
 X
KK

Atrauma-Klemmen
 Atrauma Forceps
 Pinzas Atrauma
 Pincès atraumatiques
 Pinze Atrauma



ATRAU
 nopa®



KK 635/01
 13,0 cm/5"



KK 635/02
 13,0 cm/5"



KK 635/03
 11,0 cm/4 1/2"



CASTANEDA



KK 635/04
 12,0 cm/4 3/4"



KK 635/05
 12,0 cm/4 3/4"



KK 635/06
 12,0 cm/4 3/4"



KK 635/07
 14,0 cm/4 3/4"

graduirt - graduated

Atrauma-Klemmen
 Atrauma Forceps
 Pinzas Atrauma
 Pincès atraumatiques
 Pinze Atrauma



DE BAKEY
 KK 637/12
 12,0 cm/4³/₄"

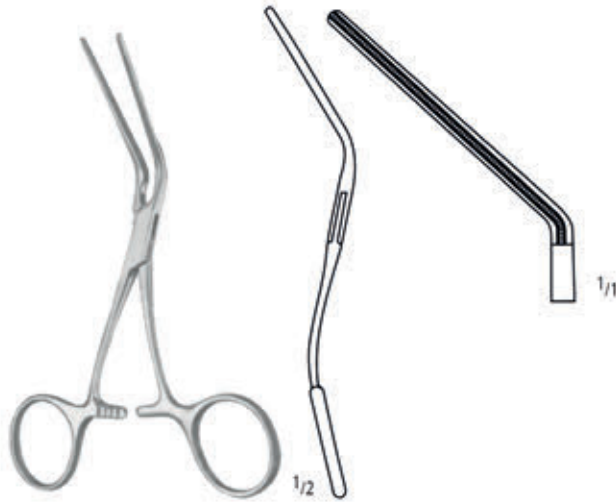

DE BAKEY
 KK 639/13
 13,0 cm/5¹/₄"



DE BAKEY
 KK 641/10
 10,0 cm/4"



DE BAKEY
 KK 643/11
 11,0 cm/4¹/₄"



DE BAKEY
 KK 645/12
 12,0 cm/4³/₄"

AA
 AB
 AC
 AD
 AE
 AF
 AG
 AH
 AI
 AJ
 AK
 AL
 AM
 AN
 AO
 AP
 AQ
 AR
 AS
 AT
 AU
 AV
 AW
 AX
 AY
 AZ

KK

Atrauma-Klemmen
 Atrauma Forceps
 Pinzas Atrauma
 Pincès atraumatiques
 Pinze Atrauma



ATRAU
 nopa®

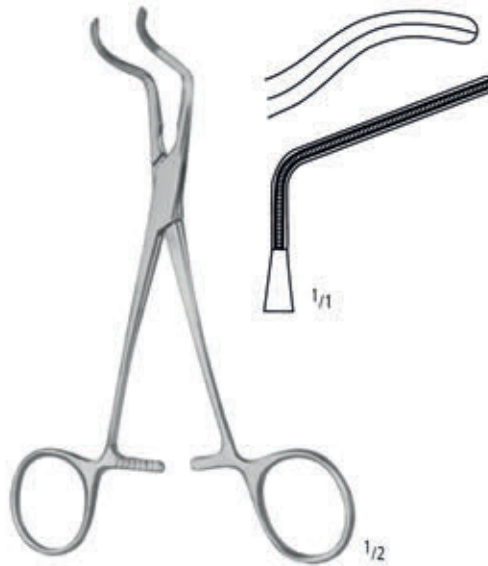

SUBRAMANIAN-MINIATURE
 KK 651/15
 15,5 cm/6"

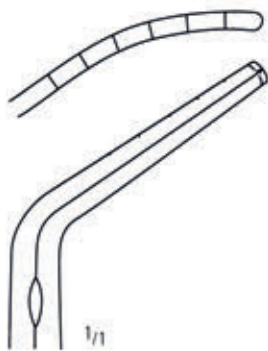

SUBRAMANIAN
 KK 653/01
 16,0 cm/6 1/4"

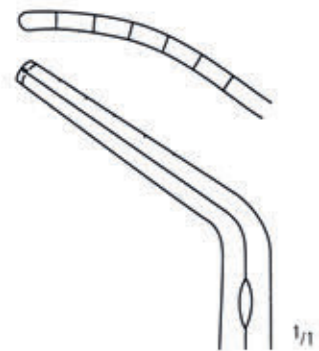

SUBRAMANIAN
 KK 653/02
 16,0 cm/6 1/4"

Bronchusklemmen, Lungenfasszangen
 Bronchus clamps, Lung grasping forceps
 Pinzas clamps bronquiales y para pulmon
 Pincas-clamps à bronches et à poumons
 Pinze per bronchi, Pinze per polmoni



PRICE-THOMAS
 KK 701/22
 22,0 cm/8³/₄"

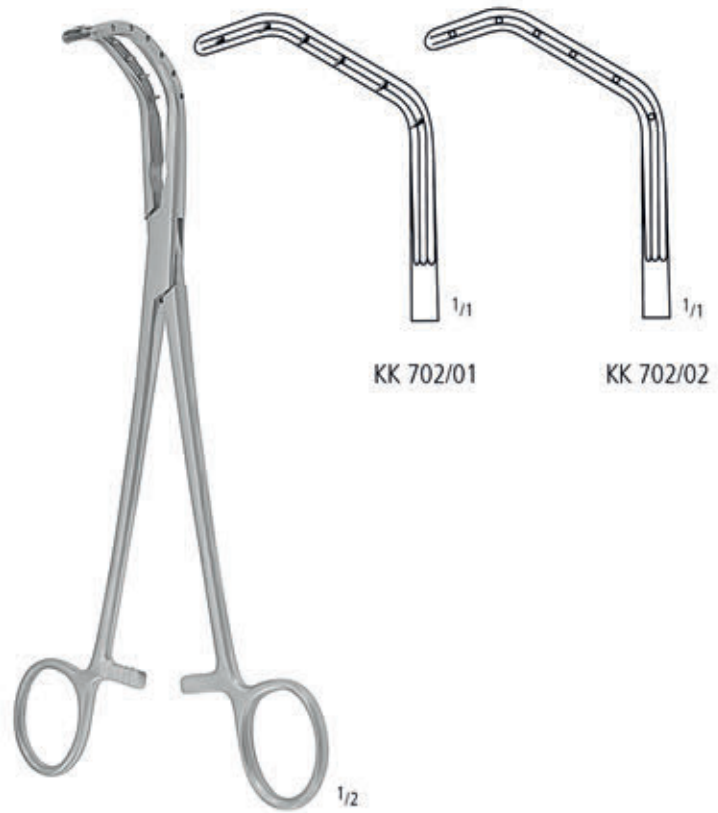

KK 702/01

KK 702/02

PRICE-THOMAS
 22,0 cm/8³/₄"



KK 703/01

KK 703/02

SEMB
 24,0 cm/9¹/₂"

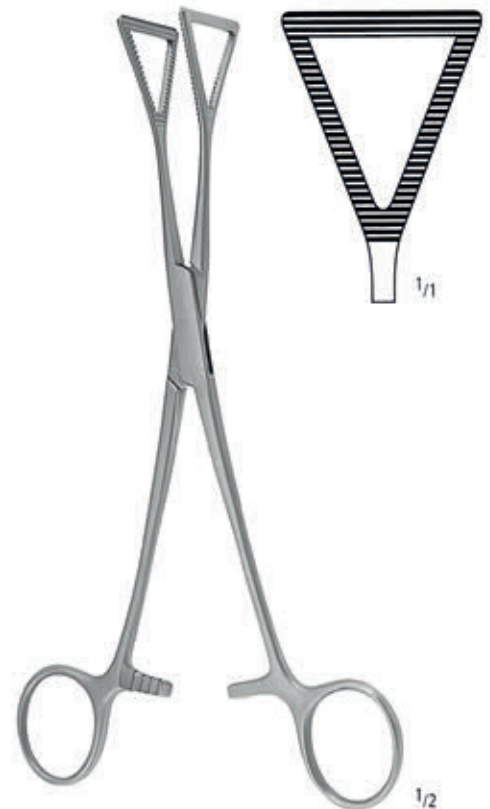

LOVELACE
 KK 704/20
 20,0 cm/8"

AA
 AB
 AC
 AD
 AE
 AF
 AK
 AL
 AO
 KA
 X
KK

Vena-Cava Klemmen
 Vena-Cava Forceps
 Clamps Vena Cava
 Pincés Vena Cava
 Pinze Vena Cava



SATINSKY
 26,0 cm/10 1/2"

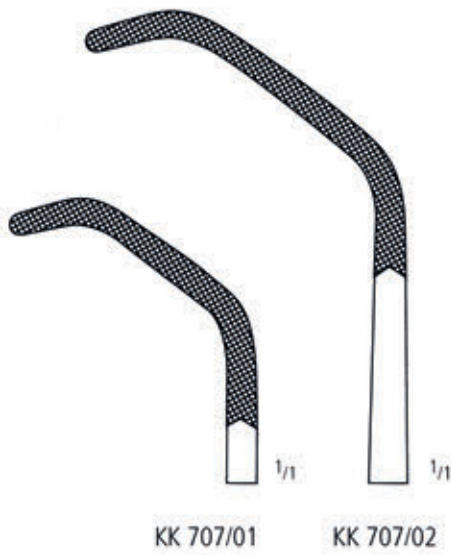

BABY-SATINSKY
 KK 708/15
 15,0 cm/6"



HARKEN
 24,0 cm/9 1/2"



24,0 cm/9 1/2"



24,0 cm/9 1/2"



24,0 cm/9 1/2"

Dilatatoren, Tourniquet
 Dilators, Tourniquets
 Diladores, Torniquetes
 Dilateurs, Tourniquets
 Dilatori, Tornichetti

AA
 AB
 AC
 AD
 AE
 AF
 AK
 AL
 AO
 KA
KK
 X



TUBBS
 KK 720/42

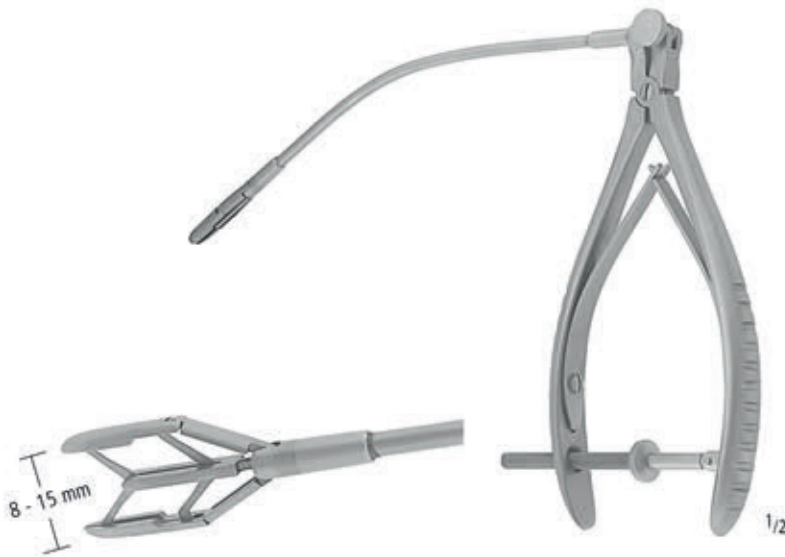

COOLEY
 KK 722/15



RUMEL-BELMONT
 Ø 3,2 mm KK 730/32
 Ø 6,4 mm KK 730/64

THORAKOSKOPIE
THORACOSCOPY
TORACOSCOPIA
THORACOSCOPIE
TORACOSCOPIA

X

nopa[®] instruments

Weitere Endoskopie-Instrumente finden Sie in unserem Katalog „Endoskopie“.

For further endoscopic instruments kindly refer to our catalogue „Endoscopy“.

Para instrumental de endoscopia adicional, por favor consulte nuestro catálogo de „Endoscopia“.

Pour des instruments d'endoscopie supplémentaires, consultez notre catalogue „Endoscopie“.

Per gli altri strumenti endoscopia, consultare il nostro catalogo „Endoscopia“.



>> Optiken • Telescopes • Opticas • Optiques • Ottiche

304–305 **1**

>> Instrumente für Laparoskopie / Thorax • Instruments for Laparoscopy / Thorax
Instrumentos para Laparoscopia / Tórax • Instruments pour Laparoscopie / Thorax
Strumenti per Laparoscopia / Torace

306–313 **3**

>> Elektroden /Saugen /Spülen /Kanülen /Trokare • Electrodes /Suction /Irrigation /Cannulae /
Trocars • Electrodos /Succión /Irrigación /Agujas /Trócares • Electrodes /Aspiration /Irrigation /
Canules /Trocarts • Elettrodi /Aspirazione /Irrigazione /Aghi speciali /Trequarti

314–325 **5**

>> HF-Zubehör • HF-accessories • AF-accesorios • HF-accessoires • AF-accessori

326–331 **7**

>> Kaltlichtquellen, Kameras • Cold light sources, cameras • Fuentes de luz fría, cámaras
Sources à lumière froide, caméras • Sorgente luce fredda, macchine fotografiche

332–341 **18**

>> Verschiedenes • Various items • Artículos diversos • Articles divers • Articoli diversi

342–343 **22**

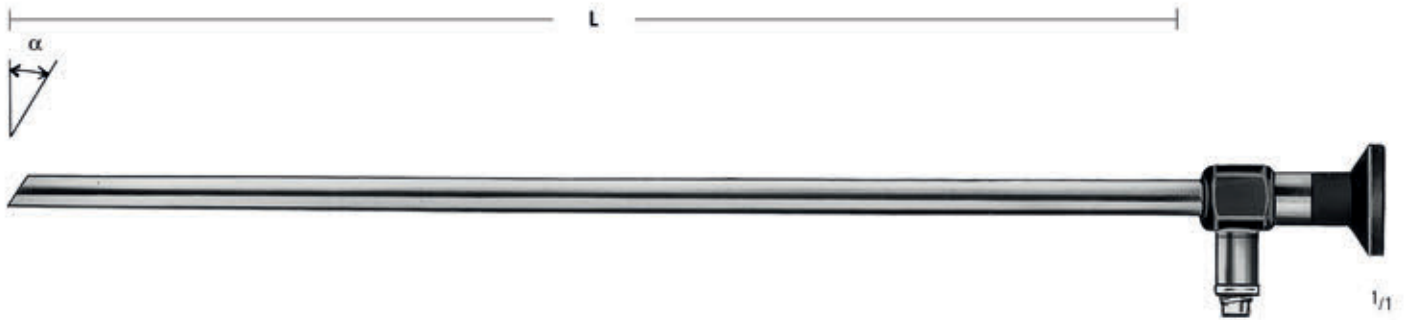

Ø mm	$\alpha = 0^\circ$	$\alpha = 30^\circ$	L
5,0	XP 720/50	XP 720/53	336 mm
6,5	XP 720/60	XP 720/63	336 mm
8,0	XP 721/80	XP 721/83	340 mm
10,0	XP 722/90	XP 722/93	344 mm

>> autoklavierbar
autoclavable

>> mit Anschluss für
with adaptors for

Storz
Wolf
ACMI

Thorakoskopie - Bronchoskopie
 Thoracoscopy - Bronchoscopy
 Toracosopia - Bronquioscopia
 Thoracoscopie - Bronchoscopie
 Toracosopia - Broncoscopia

1
3
5
7
18
22



Ø mm	$\alpha = 0^\circ$	$\alpha = 30^\circ$
10,0	XP 728/10	XP 728/13

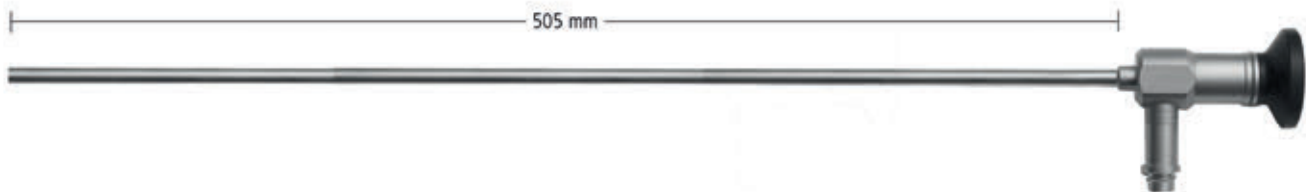

Ø mm	$\alpha = 0^\circ$	$\alpha = 30^\circ$
5,5	XP 729/50	XP 729/53

>> autoklavierbar
autoclavable

>> mit Anschluss für
with adaptors for

Storz
Wolf
ACMI

easyClean[®]

Ø 5,0 mm, 10,0 mm, 2-teilig / 2-piece

THORAX



XM 010/00



XM 014/00



XM 016/00

Bestellinformation: Bestellen Sie bitte Griff und Arbeitseinsatz
 Ordering information: Please order handle and working tip







Scharfe Präparation, Fasszangen
 Sharp Dissection, Grasping Forceps
 Disección punta, Pinzas de aprehensión
 Dissection tranchant, Pincas à Préhension
 Dissezione tagliente, Pinze da presa

easyClean[®]

Ø 5,0 mm, 10,0 mm, 2-teilig / 2-piece

THORAX

Bestellinformation: Bestellen Sie bitte Griff und Arbeitseinsatz
 Ordering information: Please order handle and working tip

		36,0 cm/14"
	Ø 5,0 mm	XM 300/01
METZENBAUM		
		
	Ø 5,0 mm	XM 300/02
PERITONEUM SCHERE PERITONEAL SCISSORS		
		
	Ø 5,0 mm	XM 300/03
MIKROSCHERE MICRO SCISSORS		
		
	Ø 5,0 mm	XM 300/04
LÖFFEL SPOON		
		
	Ø 5,0 mm	XM 300/10
STARKE GREIFZANGE STRONG GRASPER		
		
	Ø 5,0 mm	XM 300/11
GREIFZANGE GRASPING FORCEPS		

1
3
5
7
18
22

Fasszangen
Grasping Forceps
Pinzas de aprehensión
Pincers à préhension
Pinze da presa

easyClean[®]

Ø 5,0 mm, 10,0 mm, 2-teilig / 2-piece

THORAX

Bestellinformation: Bestellen Sie bitte Griff und Arbeitseinsatz
Ordering information: Please order handle and working tip

		36,0 cm/14"
	Ø 5,0 mm	XM 300/12
McKERNAN		
	Ø 5,0 mm	XM 300/13
GEZAHNTER GREIFER KOBRA TOOTHED GRASPER COBRA		
	Ø 5,0 mm	XM 300/14
FASSZANGE GEFENSTERT GRASPING FORCEPS FENSTERED		
	Ø 5,0 mm	XM 300/15
BABCOCK - ALLIS		
	Ø 10,0 mm	XM 300/16
DUVAL		

Fasszangen
Grasping Forceps
Pinzas de aprehensión
Pincas à préhension
Pinze da presa

easyClean[®]

Ø 5,0 mm, 10,0 mm, 2-teilig / 2-piece

THORAX

Bestellinformation: Bestellen Sie bitte Griff und Arbeitseinsatz
Ordering information: Please order handle and working tip



		36,0 cm/14"
	Ø 10,0 mm	XM 300/17
	Ø 5,0 mm	XM 300/18
	Ø 5,0 mm	XM 300/19







1
3
5
7
18
22

Scharfe Präparation, Faszangen
 Sharp Dissection, Grasping Forceps
 Disección punta, Pinzas de aprehensión
 Dissection tranchant, Pincas à Préhension
 Dissezione tagliente, Pinze da presa

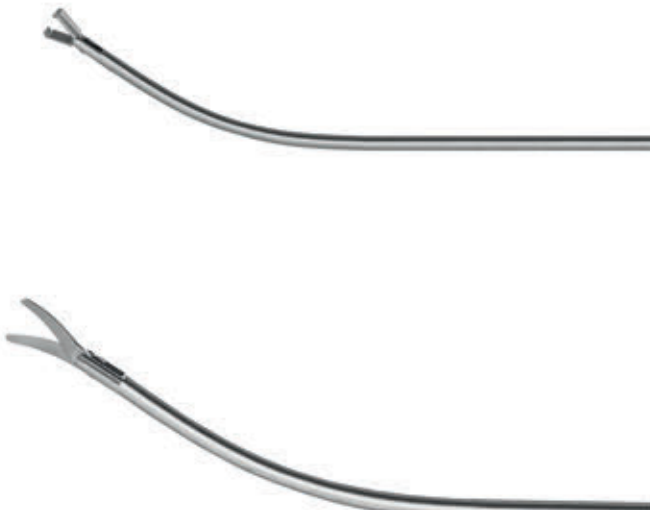
Ø 5,0 mm, 10,0 mm, 1-teilig / 1-piece

THORAX



	Ø 5,0 mm	36,0 cm/14"	XM 301/01
<p>METZENBAUM</p> 	Ø 5,0 mm	XM 301/02	XM 301/02
<p>PERITONEUM SCHERE PERITONEAL SCISSORS</p> 	Ø 5,0 mm	XM 301/03	XM 301/03
<p>MIKROSCHERE MICRO SCISSORS</p> 	Ø 5,0 mm	XM 301/04	XM 301/04
<p>LÖFFEL SPOON</p> 	Ø 5,0 mm	XM 301/10	XM 301/10
<p>STARKE GREIFZANGE STRONG GRASPER</p> 	Ø 5,0 mm	XM 301/11	XM 301/11
<p>GREIFZANGE GRASPING FORCEPS</p> 	Ø 5,0 mm	XM 301/11	XM 301/11

Fasszangen
Grasping Forceps
Pinzas de aprehensión
Pincers à préhension
Pinze da presa

Ø 5,0 mm, 10,0 mm, 1-teilig / 1-piece

THORAX

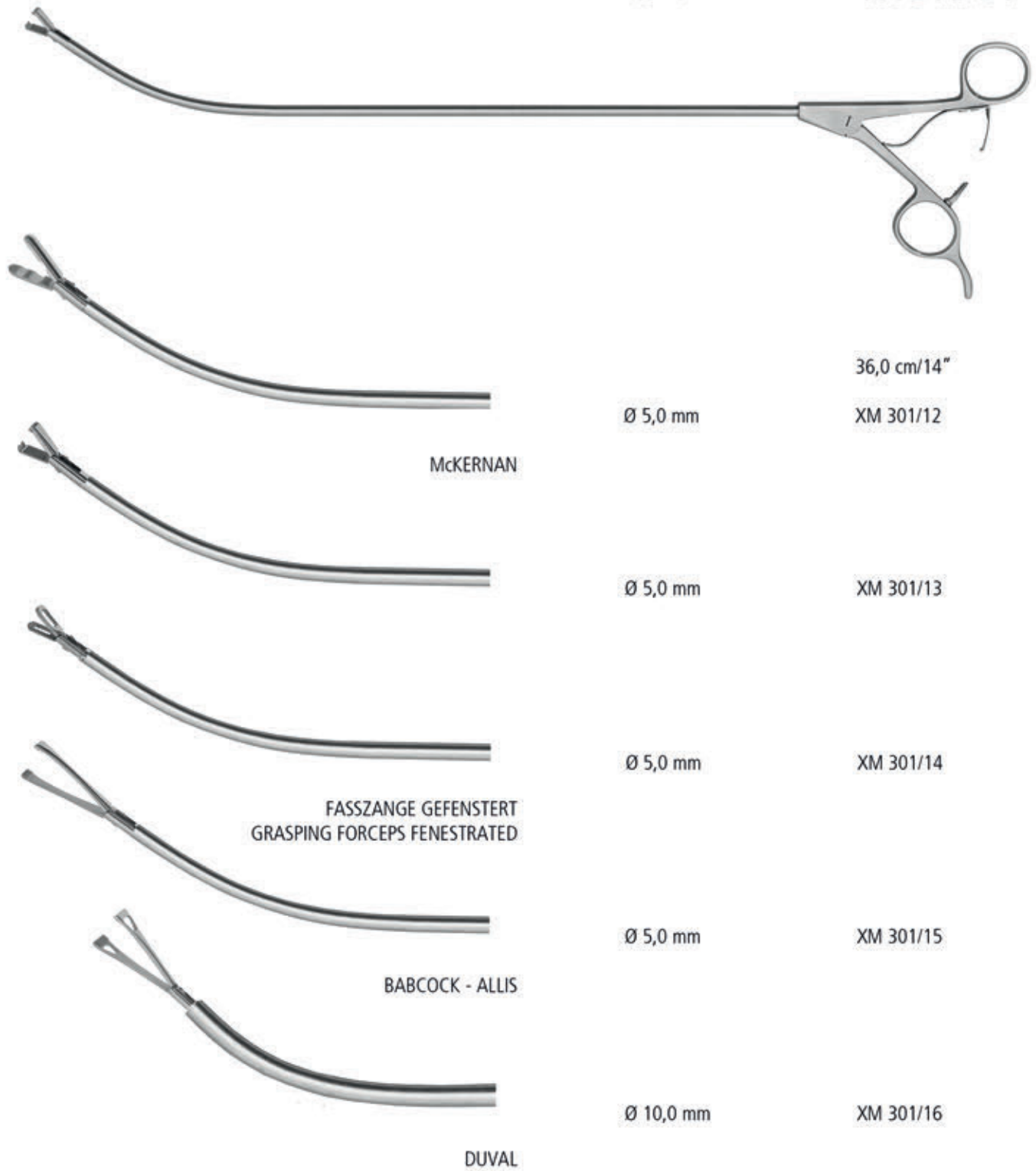

1
3
5
7
18
22

Fasszangen
Grasping Forceps
Pinzas de aprehensión
Pinces à préhension
Pinze da presa

Ø 5,0 mm, 10,0 mm, 1-teilig / 1-piece

THORAX

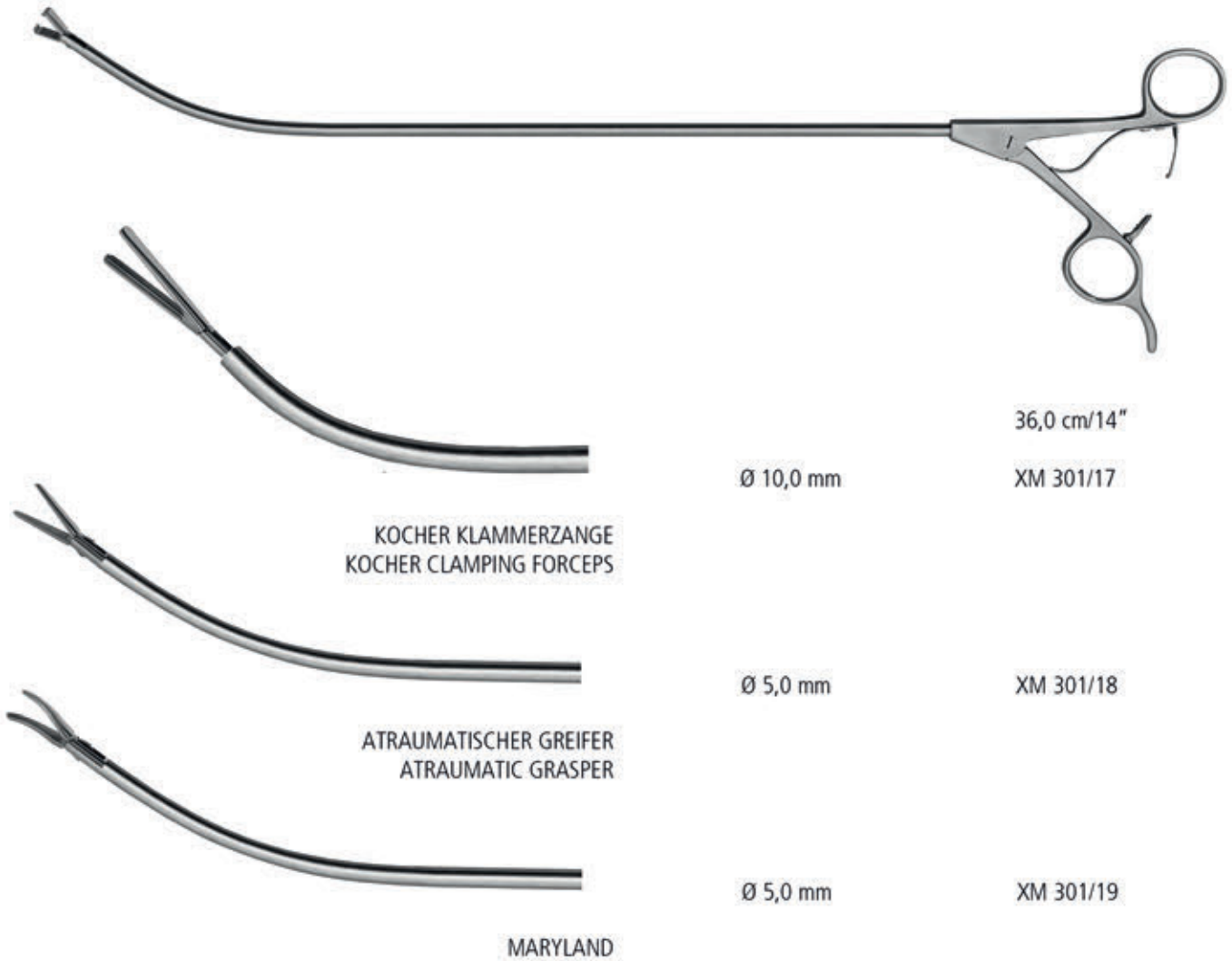

ENDOSKOPIE ENDOSCOPY ENDOSCOPIA ENDOSCOPIE ENDOSCOPIA

Retraktoren
Retractors
Separadores
Ecarteurs
Divaricatori

1
3
5
7
18
22



1/2

Ø 10,0 mm

XM 570/00



L = 50,0 mm

XM 570/50



1/2

L = 75,0 mm

XM 570/75

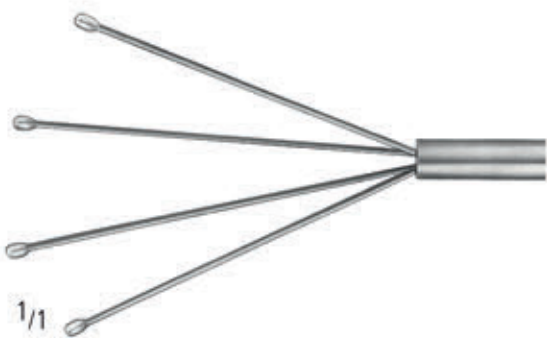
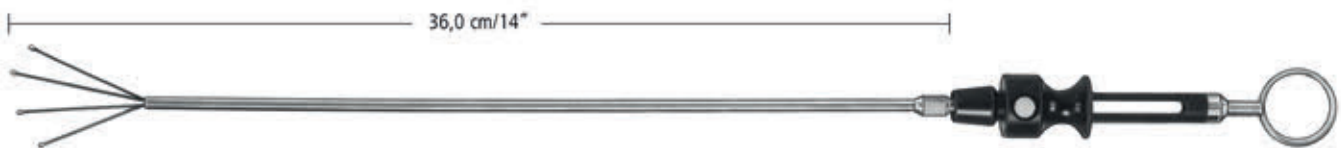

Ø 5,0 mm

XM 571/05

1/1

Elektroden mit Absaugung
 Electrodes with suction tube
 Electrodo con tubo de succión
 Electrodes avec canule d'aspiration
 Elettrodi con tubo d'aspirazione

nopa econom

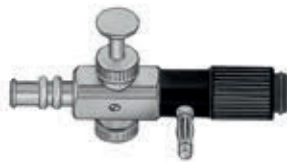
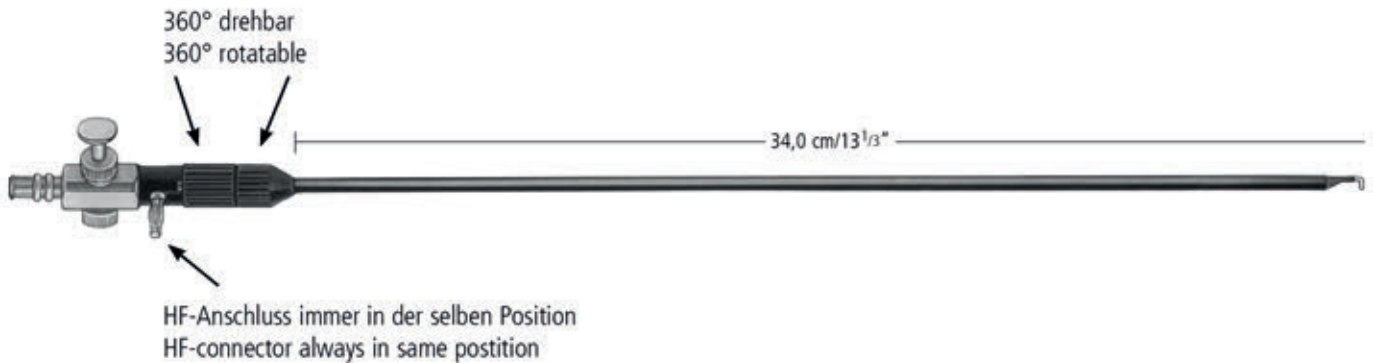

XK 546/00

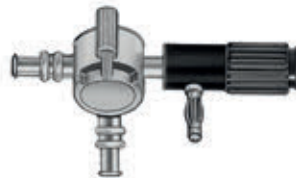

XK 547/00



XK 548/00

perfekte Reinigung
 perfect cleaning



Ø 5,0 mm
 XK 549/01



Ø 5,0 mm
 XK 549/02



Ø 5,0 mm
 XK 549/03



Ø 5,0 mm
 XK 549/04



nopa-econom Elektroden sind durch LUER-LOCK Kupplung leicht auseinandernehmbar. Trotz Verwendung von hochwertigstem Isoliermaterial werden Elektrodenschäfte immer wieder durch unsachgemäße Handhabung oder Reinigung beschädigt. Das nopa System garantiert schnelles und enorm kostengünstiges Auswechseln. Durch unsere Kombinationsmöglichkeiten ergeben sich bereits bei der Grundausstattung erhebliche wirtschaftliche Vorteile.

nopa-econom electrodes are easy to take apart by means of a LUER-LOCK coupling (connection). Although our electrode shafts are coated with superb insulation material, the insulation is very often damaged due to improper handling or cleaning procedures. The nopa system guarantees a fast, reliable and inexpensive exchange of shafts. The combination possibilities offer enormous cost advantages even for a basic instrument set.

Elektroden mit Absaugung
 Electrodes with suction tube
 Electrodo con tubo de succión
 Electrodes avec canule d'aspiration
 Elettrodi con tubo d'aspirazione



Ø 5,0 mm XK 550/01



Ø 5,0 mm XK 550/02



Ø 5,0 mm XK 550/03



Ø 5,0 mm XK 550/04



Ø 5,0 mm XK 550/05

1
3
5
7
18
22

5 ENDOSKOPIE ENDOSCOPY ENDOSCOPIA ENDOSCOPIE ENDOSCOPIA

Elektroden mit Absaugung
 Electrodes with suction tube
 Electrodo con tubo de succión
 Electrodes avec canule d'aspiration
 Elettrodi con tubo d'aspirazione



Ø 5,0 mm XK 554/01



Ø 5,0 mm XK 554/02



Ø 5,0 mm XK 554/03



Ø 5,0 mm XK 554/04



Ø 5,0 mm XK 554/05

ENDOSKOPIE ENDOSCOPY ENDOSCOPIA ENDOSCOPIE ENDOSCOPIA

Elektroden ohne Absaugung
 Electrodes without suction tube
 Electrodoes sin tubo de succión
 Electrodes sans canule d'aspiration
 Elettrodi senza tubo d'aspirazione



Ø 5,0 mm XK 556/01



Ø 5,0 mm XK 556/02



Ø 5,0 mm XK 556/03



Ø 5,0 mm XK 556/04



Ø 5,0 mm XK 556/05

1
3
5
7
18
22

5 ENDOSKOPIE ENDOSCOPY ENDOSCOPIA ENDOSCOPIE ENDOSCOPIA

Saug- und Spülrohre, Punktionskanülen
 Suction and irrigation tubes, Puncture needles
 Cánulas de aspiración, Agujas para punción
 Canules d'aspiration, Aiguilles pour ponction
 Cannule per aspirazione, Aghi per puntura

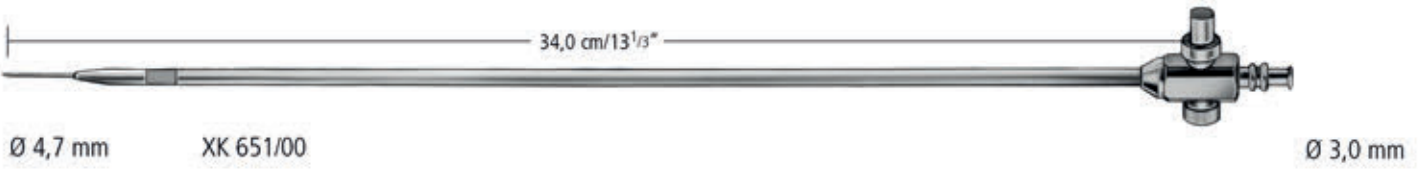

Saug- und Spülrohre
Suction and irrigation tubes
Cánulas de aspiración
Canules d'aspiration
Cannule per aspirazione



Saug und Spül Pistolenhandgriff
Suction and irrigation handle

XK 663/01

1
3
5
7
18
22



Ø 3,0 mm

XK 663/03



Ø 5,0 mm

XK 663/05



Ø 10,0 mm

XK 663/10

XK 663/00 = XK 663/01
XK 663/03
XK 663/05
XK 663/10

Elektroden mit Absaugung
 Electrodes with suction tube
 Electrodoos con tubo de succión
 Electrodes avec canule d'aspiration
 Elettrodi con tubo d'aspirazione



Saug und Spül Pistolenhandgriff
 Suction and irrigation handle

XK 663/01

Adapter für Elektroden
 Adaptor for electrodes



XK 663/20



Ø 5,0 mm

XK 549/01



Ø 5,0 mm

XK 549/02



Ø 5,0 mm

XK 549/03



Ø 5,0 mm

XK 549/04

nopa-econom Elektroden sind durch LUER-LOCK Kupplung leicht auseinandernehmbar. Trotz Verwendung von hochwertigstem Isoliermaterial werden Elektrodenschäfte immer wieder durch unsachgemäße Handhabung oder Reinigung beschädigt. Das nopa System garantiert schnelles und enorm kostengünstiges Auswechseln. Durch unsere Kombinationsmöglichkeiten ergeben sich bereits bei der Grundausstattung erhebliche wirtschaftliche Vorteile.

nopa-econom electrodes are easy to take apart by means of a LUER-LOCK coupling (connection). Although our electrode shafts are coated with superb insulation material, the insulation is very often damaged due to improper handling or cleaning procedures. The nopa system guarantees a fast, reliable and inexpensive exchange of shafts. The combination possibilities offer enormous cost advantages even for a basic instrument set.

Trokarhülsen und Trokare
Trocar sleeves and trocars
Camisa para trocares y trocares
Trocards à manche et trocards
Manicotti trequarti e trequarti

THORAX



Satz

Set

Ø 6,0 mm	L=5,0 cm/2"	XK 645/06
Ø 11,0 mm	L=5,0 cm/2"	XK 645/11
Ø 13,0 mm	L=5,0 cm/2"	XK 645/13

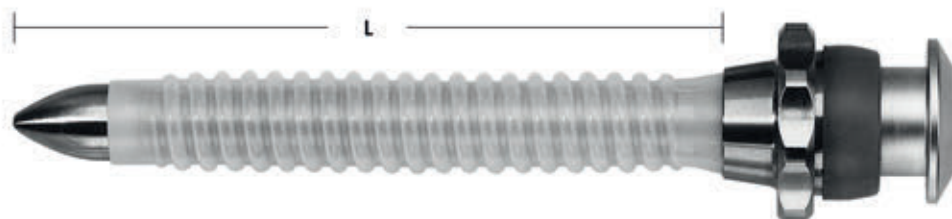

Satz

Set

Ø 6,0 mm	L=7,0 cm/2 ³ / ₄ "	XK 647/06
Ø 6,0 mm	L=10,0 cm/4"	XK 647/16
Ø 11,0 mm	L=7,0 cm/2 ³ / ₄ "	XK 648/11
Ø 11,0 mm	L=10,0 cm/4"	XK 648/21

Flexible Kunststoffrohre, Verpackungseinheit 5 Stück

Flexible plastic tubes, packing unit 5 pieces

Ø 6,0 mm	L=7,0 cm/2 ³ / ₄ "	XK 647/26
Ø 6,0 mm	L=10,0 cm/4"	XK 647/36
Ø 11,0 mm	L=7,0 cm/2 ³ / ₄ "	XK 648/31
Ø 11,0 mm	L=10,0 cm/4"	XK 648/41

Trokarhülsen und Trokare
Trocar sleeves and trocars
Camisa para trocares y trocares
Trocards à manche et trocards
Manicotti trequarti e trequarti

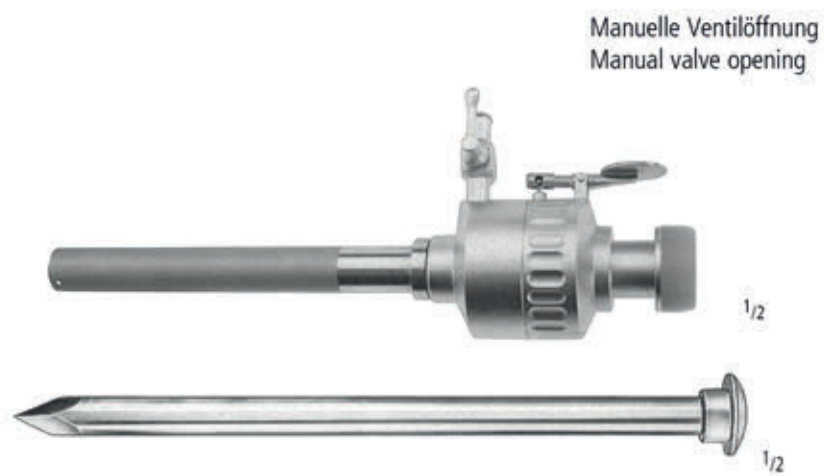

Satz		
Set		
Ø	3,5 mm	XK 650/03
Ø	5,0 mm	XK 650/05
Ø	5,5 mm	XK 650/06
Ø	10,0 mm	XK 650/10
Ø	11,0 mm	XK 650/11
Ø	12,5 mm	XK 650/12

Trokarhülsen und Trokare
Trocar sleeves and trocars
Camisa para trocares y trocares
Trocards à manche et trocards
Manicotti trequarti e trequarti

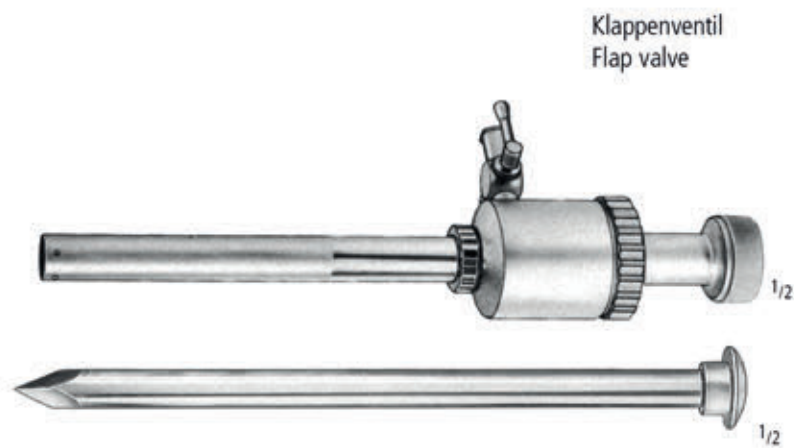

Satz		
Set		
Ø	3,5 mm	XK 652/03
Ø	5,0 mm	XK 652/05
Ø	5,5 mm	XK 652/06
Ø	10,0 mm	XK 652/10
Ø	11,0 mm	XK 652/11
Ø	12,5 mm	XK 652/12

1

3

5

7

18

22

5 ENDOSKOPIE ENDOSCOPY ENDOSCOPIA ENDOSCOPIE ENDOSCOPIA

Trokaraufsätze, Reduzierstücke
 Trocar stop with thread, Reducers
 Tope de trocar con cuerda, Reductores
 Stop trocards, Reducteurs
 Inserto per tre quarti, Riduttore



Ø 5,5 mm XK 700/05
 Ø 11,0 mm XK 700/11



Ø 5,0 mm XK 702/05
 Ø 5,5 mm XK 702/06
 Ø 10,0 mm XK 702/10
 Ø 11,0 mm XK 702/11
 Ø 12,0 mm XK 702/12



Ø 10,0 mm → 5,5 mm XK 706/01
 Ø 11,0 mm → 5,5 mm XK 706/02
 Ø 12,5 mm → 5,5 mm XK 706/03
 Ø 12,5 mm → 10,0 mm XK 706/04

ENDOSKOPIE ENDOSCOPY ENDOSCOPIA ENDOSCOPIE ENDOSCOPIA

Trocarhülsen und Trokare
Trocar sleeves and trocars
Camisa para trocares y trocares
Trocards à manche et trocards
Manicotti trequarti e trequarti



- Ø 5,0 mm XK 750/05
- Ø 8,0 mm XK 750/08
- Ø 10,0 mm XK 750/10
- Ø 11,0 mm XK 750/11
- Ø 12,5 mm XK 750/12



- Ø 5,0 mm XK 751/05
- Ø 12,5 mm XK 751/12
- Ø 15,0 mm XK 751/15
- Ø 20,0 mm XK 751/20



- | | | | |
|-----------|-----------|-----------|-----------|
| | | | |
| Ø 3,5 mm | XK 760/03 | XK 761/03 | XK 762/03 |
| Ø 5,0 mm | XK 760/05 | XK 761/05 | XK 762/05 |
| Ø 5,5 mm | XK 760/06 | XK 761/06 | XK 762/06 |
| Ø 8,0 mm | XK 760/08 | XK 761/08 | XK 762/08 |
| Ø 10,0 mm | XK 760/10 | XK 761/10 | XK 762/10 |
| Ø 11,0 mm | XK 760/11 | XK 761/11 | XK 762/11 |
| Ø 12,5 mm | XK 760/12 | XK 761/12 | XK 762/12 |
| Ø 15,0 mm | XK 760/15 | XK 761/15 | XK 762/15 |
| Ø 20,0 mm | XK 760/20 | XK 761/20 | XK 762/20 |



- Ø 5,0 mm XK 763/05
- Ø 5,5 mm XK 763/06
- Ø 10,0 mm XK 763/10
- Ø 11,0 mm XK 763/11
- Ø 12,5 mm XK 763/12



- Ø 5,0 mm XK 765/05
- Ø 8,0 mm XK 765/08
- Ø 10,0 mm XK 765/10
- Ø 11,0 mm XK 765/11
- Ø 12,5 mm
- Ø 15,0 mm
- Ø 20,0 mm



- XK 766/05
- XK 766/08
- XK 766/10
- XK 766/11
- XK 766/12



- XK 766/15
- XK 766/20



- XK 767/05
- XK 767/08
- XK 767/10
- XK 767/11
- XK 767/12
- XK 767/15
- XK 767/20

1
3
5
7
18
22

Anschlusskabel
 Connection cords
 Cables de conexión
 Câbles de raccordement
 Cavi da connessione

monopolar

bipolar



MARTIN / BERCHTOLD

300 cm	XR 827/03	XR 828/03	XR 830/03
500 cm	XR 827/05	XR 828/05	XR 830/05

monopolar

bipolar

monopolar

bipolar



	ERBE	ERBE	ERBE/SELECT	ERBE	VALLEYLAB
300 cm	XR 831/03	XR 831/13	XR 832/03	XR 833/03	XR 834/03
500 cm	XR 831/05	XR 831/15	XR 832/05	XR 833/05	XR 834/05
	(ACC/ICC)	(T-Serie)			(in D nicht zulässig nach MedGV)

Elektroden
Electrodes
Electrodos
Electrodes
Elettrodi

universal



XR 841/01



XR 841/02



XR 841/03



XR 841/04



XR 841/05



XR 841/06



XR 841/07



XR 841/08



XR 841/09



XR 841/10



XR 841/11



XR 841/12

1
3
5
7
18
22

Elektroden
Electrodes
Electrodos
Electrodes
Elettrodi

universal



XR 843/01



XR 843/02



XR 843/03



XR 843/04



XR 843/05



XR 843/06



XR 843/07



XR 843/08



XR 843/09

ENDOSKOPIE ENDOSCOPY ENDOSCOPIA ENDOSCOPIE ENDOSCOPIA

Pinzetten monopolar
 Forceps monopolar
 Pinzas monopolares
 Pincas monopolaires
 Pinze monopolari



14,5 cm/5 ³ / ₄ "			XR 882/15
16,0 cm/6 ¹ / ₄ "			XR 882/16
18,0 cm/7"	XR 880/18	XR 881/18	
20,0 cm/8"			XR 882/20
21,0 cm/8 ¹ / ₄ "	XR 880/21	XR 881/21	
25,0 cm/10"	XR 880/25	XR 881/25	



mit Stecker
 with plug
 con clavija
 avec fiche
 con spina

mit Buchse
 with jack
 con enchufe
 avec douille
 con presa

14,5 cm/5 ³ / ₄ "			XR 885/15		XR 888/15
16,0 cm/6 ¹ / ₄ "			XR 885/16		XR 888/16
18,0 cm/7"	XR 883/18	XR 884/18		XR 886/18	XR 887/18
20,0 cm/8"			XR 885/20		XR 888/20
21,0 cm/8 ¹ / ₄ "	XR 883/21	XR 884/21		XR 886/21	XR 887/21
25,0 cm/10"	XR 883/25	XR 884/25		XR 886/25	XR 887/25

1
3
5
7
18
22

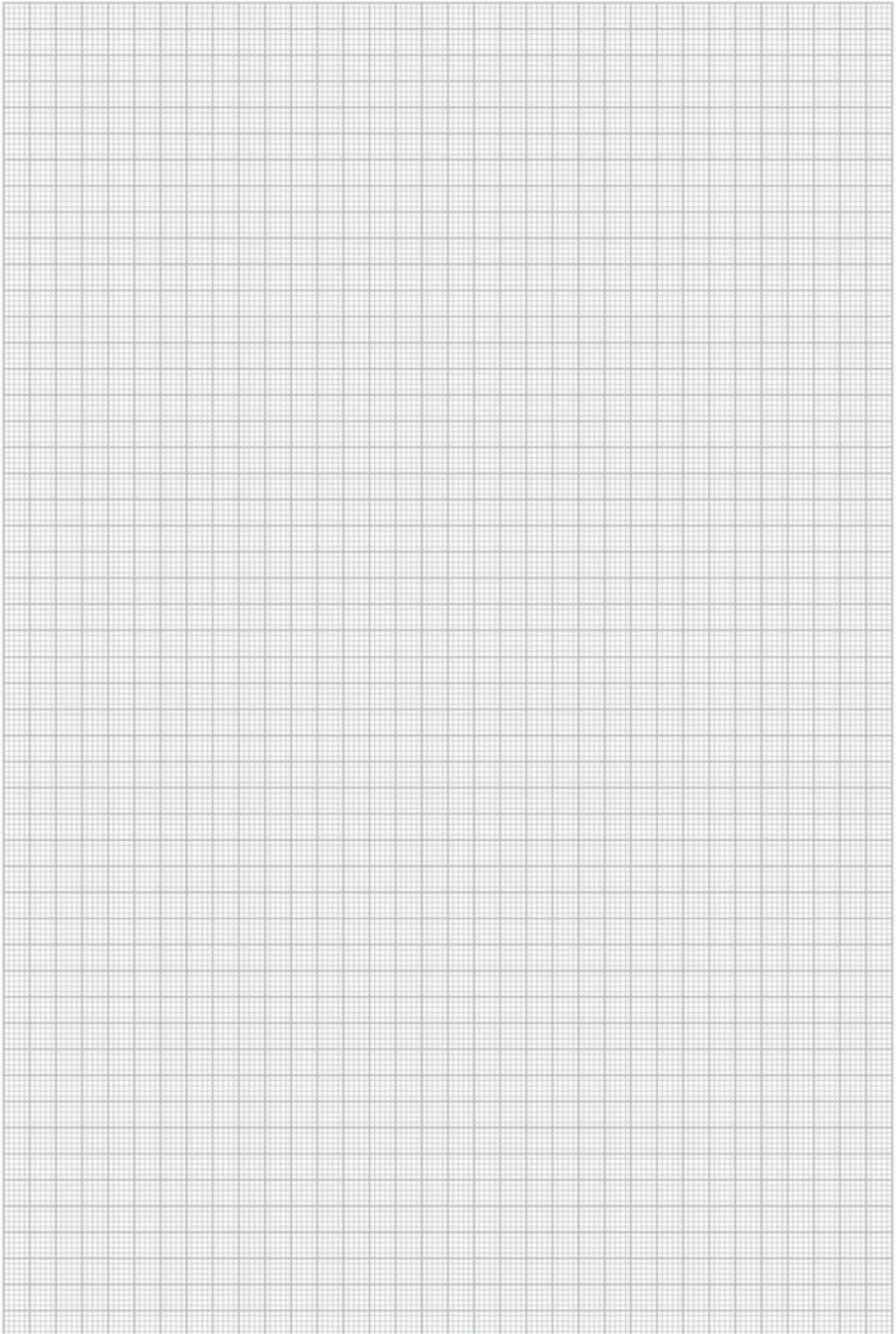

ENDOSKOPIE ENDOSCOPY ENDOSCOPIA ENDOSCOPIE ENDOSCOPIA

Bi-Koagulations-Pinzetten
 Bi-Coagulation-Forceps
 Pinzas para la Bi-Coagulación
 Pince pour la Bi-Coagulation
 Pinze per la Bi-Coagulazione



16,0 cm/6 ¹ / ₄ "	XR 890/16 A	XR 891/16 C	XR 894/16 C		
16,0 cm/6 ¹ / ₄ "	XR 890/16 C	XR 891/16 D	XR 894/16 D		
16,0 cm/6 ¹ / ₄ "	XR 890/16 E	XR 891/16 E	XR 894/16 E		
20,0 cm/8"	XR 890/20 A	XR 891/20 A	XR 894/20 A		
20,0 cm/8"	XR 890/20 C	XR 891/20 C	XR 894/20 C	XR 895/20 C	XR 896/20 C
20,0 cm/8"	XR 890/20 E	XR 891/20 F	XR 894/20 E		
20,0 cm/8"			XR 894/20 F		
22,0 cm/8 ³ / ₄ "	XR 890/22 A	XR 891/22 C	XR 894/22 D		
22,0 cm/8 ³ / ₄ "	XR 890/22 C		XR 894/22 E	XR 895/22 C	XR 896/22 C

A=2,0 mm

C=1,0 mm



D=0,5 mm

E=Nadel

F=Profil



11,0 cm/4 ¹ / ₃ "	XR 898/11 D	XR 899/11 D
11,0 cm/4 ¹ / ₃ "	XR 898/11 E	XR 899/11 E

Kaltlichtkabel
 Fibre optic cable
 Cable fibra óptica
 Câble fibre optique
 Cavo fibra ottica



XT 035/18	Ø 3,5 mm, 180 cm
XT 035/23	Ø 3,5 mm, 230 cm
XT 035/30	Ø 3,5 mm, 300 cm
XT 045/18	Ø 4,5 mm, 180 cm
XT 045/23	Ø 4,5 mm, 230 cm
XT 045/30	Ø 4,5 mm, 300 cm
XT 060/18	Ø 6,0 mm, 180 cm
XT 060/23	Ø 6,0 mm, 230 cm
XT 060/30	Ø 6,0 mm, 300 cm

Kaltlicht-Grundkabel Basic fibre optic cable

- >> **Zusätzliche Isolierung**
- >> **Metallspirale**
- >> **Silikonmantel**
- >> **Sterilisierbar**
- >> **48-Stunden Reparatur-Service**

- >> **Additionally insulated**
- >> **Metal spiral**
- >> **Silicon tube**
- >> **Autoclavable**
- >> **48-hour repair-service**

Adapter
Adapter
Adaptador
Adaptateur
Adattatore

Projektor-Seite
Projector side

Endoskop-Seite
Endoscope side

XT 100/01



STORZ



XT 100/11

STORZ/WINTER + IBE
OPLYMPUS/STRYKER

XT 100/02



WOLF/HENKE-SASS



XT 100/12

WOLF/HENKE-SASS

XT 100/03



ACM/HEINE



XT 100/13

ACM/HEINE

XT 100/04



WINTER + IBE

XT 100/05



OPLYMPUS

Bestellinformation / Ordering information

>> Bitte bestellen Sie Kaltlicht-
grundkabel mit 2 Adaptern

>> Please order the basic fibre
optic cable and two adapters

1
3
5
7
18
22

Kaltlichtquellen
Cold light sources
Fuente de luz fría
Source à lumière froide
Sorgente luce fredda

nopa® light halogen 2 x 250W future 100



XT 170/00 = 110 - 230 VAC

XT 169/00 = Ersatzlampe
Spare bulb
Bombilla de recambio
Lampe de rechange
Lampadina di ricambio

nopa light halogen 2 x 250W

Beschreibung XT 170/00

Die nopalight halogen 2 x 250 W Lichtquelle kann bei allen Einsätzen angewendet werden, besonders dann, wenn eine starke Ausleuchtung oder eine Videoaufzeichnung notwendig ist.

Alle modernen Autoshutter-Videokameras werden mit ausreichender Lichtzufuhr versorgt. Die zweite Lampe wird als Reserve bei Lampendefekten oder Lampenausfall durch sofortiges Umschalten während den Einsätzen aktiviert.

Spezielle Wärmeschutzfilter sorgen für eine Schonung der Lichtleiter und eine optimale Lichtfiltrierung. Das Gerät ist MedGV-geprüft.

Technische Daten

Elektr. Versorgung: 100-240 VAC/50-60Hz
Weltnetzteil

Farbtemperatur: über 3500° K

Lichtregelung: automatisch, stufenlos

Maße
(B x H x T): 355 x 110 x 320 mm

Gewicht: ca. 8,5 kg

Zubehör

Lampe XT 169/00: 250 Watt Halogen

nopa light halogen 2 x 250W

Description XT 170/00

The nopalight halogen 2 x 250 W lightsource can be utilized in all procedures, especially if a strong illumination or video-monitoring is required.

All modern autoshutter-videocameras will be supplied with sufficient light-intensity, the second lamp serves as stand-by. Simply switch-over.

Special temperature-filters guarantee long life of light cables and optimal light output. The nopalight halogen 2 x 250 W lightsource is approved by MedGV.

Technical data

Power supply: 100-240 VAC/50-60Hz
world power supply

Color temperature: more than 3500° K

Light control: automatic

Measurements
(W x H x D): 355 x 110 x 320 mm

Weight: approx. 8,5 kg

Accessories

Bulb XT 169/00: 250 Watt Halogen

Kaltlichtquellen
Cold light sources
Fuente de luz fria
Source à lumière froide
Sorgente luce fredda

nopa® light halogen 2 x 250W future 100 duo

XT 171/00	=	110 - 230 VAC
XT 169/00	=	Ersatzlampe Spare bulb Bombilla de recambio Lampe de rechange Lampadina di ricambio



nopa light halogen 2 x 250W

Beschreibung XT 171/00

Die nopalight halogen 2 x 250 W Lichtquelle kann bei allen Einsätzen angewendet werden, besonders dann, wenn eine starke Ausleuchtung oder eine Videoaufzeichnung notwendig ist.

Alle modernen Autoshutter-Videokameras werden mit ausreichender Lichtzufuhr versorgt. Zwei Lampen - zwei umschaltbare Ausgänge.

Spezielle Wärmeschutzfilter sorgen für eine Schonung der Lichtleiter und eine optimale Lichtfiltrierung. Das Gerät ist MedGV-geprüft.

Technische Daten

Elektr. Versorgung:	100-240VAC/50-60Hz Weltnetzteil
Farbtemperatur:	über 3500° K
Lichtregelung:	automatisch, stufenlos
Maße (B x H x T):	355 x 110 x 320 mm
Gewicht:	ca. 8,5 kg

Zubehör

Lampe XT 169/00:	250 Watt Halogen
------------------	------------------

nopa light halogen 2 x 250W

Description XT 171/00

The nopalight halogen 2 x 250 W lightsource, can be utilized in all procedures, especially if a strong illumination or video-monitoring is required.

All modern autoshutter-videocameras will be supplied with sufficient light-intensity, the second lamp serves as stand-by. Two bulbs - two outlets switchable.

Special temperature-filters guarantee long life of light cables and optimal light output. The nopalight halogen 2 x 250 W lightsource is approved by MedGV.

Technical data

Power supply:	100-240VAC/50-60Hz world power supply
Color temperature:	more than 3500° K
Light control:	automatic
Measurements (W x H x D):	355 x 110 x 320 mm
Weight:	approx. 8,5 kg

Accessories

Bulb XT 169/00:	250 Watt Halogen
-----------------	------------------

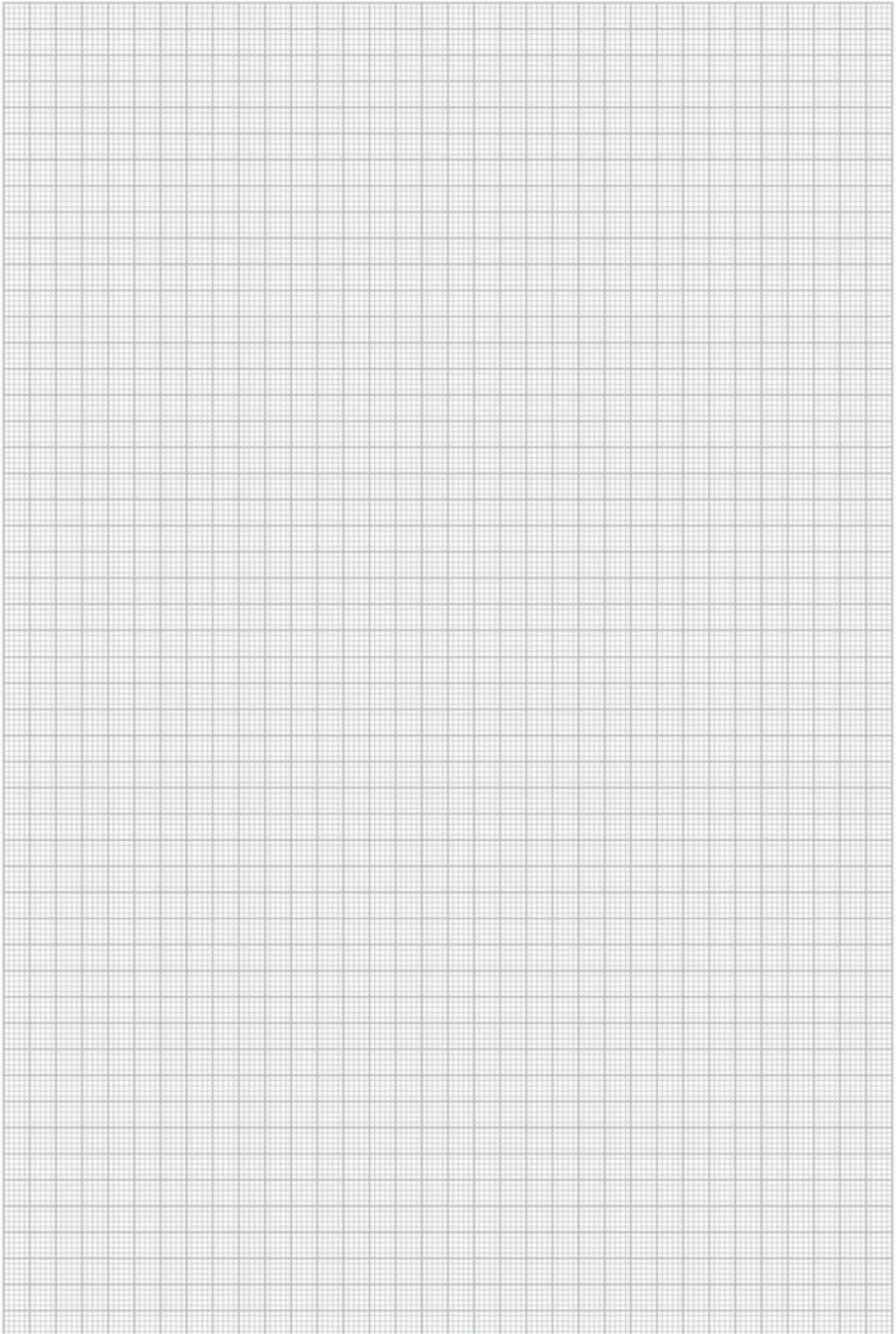

Kaltlichtquellen
Cold light sources
Fuente de luz fria
Source à lumière froide
Sorgente luce fredda

nopa® light xenon future 200 180W

XT 205/00 = 110-230 VAC/50-60 Hz

XT 204/00 = Ersatzlampe
Spare bulb
Bombilla de recambio
Lampe de rechange
Lampadina di ricambio



nopa light xenon 180W

Beschreibung XT 205/00

Die nopalight xenon 180 Watt Lichtquelle kann bei allen Einsätzen angewendet werden, besonders dann, wenn eine starke Ausleuchtung oder eine Videoaufzeichnung notwendig ist.

Alle modernen Autoshutter-Videokameras werden mit ausreichender Lichtzufuhr versorgt. Die hohe Lichtausgangsleistung sorgt für absolut weißes Licht >5600°K und somit für detailgetreue Farbwiedergabe.

Unsere spezielle Lampenkonstruktion mit geringster Wärmeentwicklung führt zu absolut kaltem Licht und verhindert eine thermische Beschädigung der Lichtleiter.

Weitere Vorteile: Geringe Luftverwirbelungen, geringe Geräuschentwicklung, umweltfreundliche Lampe, einfachster Lampenwechsel.

Technische Daten

Elektr. Versorgung:	110-230 VAC/50-60Hz Weltnetzteil
Farbtemperatur:	> 5600° K
Maße (B x H x T):	355 x 110 x 320 mm
Gewicht:	ca. 9,5 kg

Zubehör

Lampe XT 204/00:	180 Watt Xenon
------------------	----------------

nopa light xenon 180W

Description XT 205/00

The nopalight xenon 180 watt light source can be used for all occasions particularly where strong illumination or a video recording is necessary.

All modern autoshutter videocameras are supplied with sufficient light. The high light output ensures absolute white light >5600° K and thus detail fidelity in colour reproduction.

Our special lamp construction which has the lowest of heat generation leads to absolute cold light and prevents thermal damage to the light conductor.

Further advantages are low air turbulence, low noise level, environmentally friendly lamp and very easy bulb replacement.

Technical data

Power supply:	110-230 VAC/50-60Hz world power supply
Colour temperature:	> 5600° K
Measurements (W x H x D):	355 x 110 x 320 mm
Weight:	approx. 9,5 kg

Accessories

Bulb XT 204/00:	180 Watt Xenon
-----------------	----------------

Kaltlichtquellen
Cold light sources
Fuente de luz fría
Source à lumière froide
Sorgente luce fredda

nopa[®] light xenon future 300 300W



XT 210/00 = 110-230 VAC/50-60 Hz

XT 209/00
Ersatzlampe
Spare bulb
Bombilla de recambio
Lampe de rechange
Lampadina di ricambio

nopa light xenon 300 W

Beschreibung XT 210/00

Die nopalight xenon 300 Watt Lichtquelle kann bei allen Einsätzen angewendet werden, besonders dann, wenn eine starke Ausleuchtung oder eine Videoaufzeichnung notwendig ist.

Alle modernen Autoshutter-Videokameras werden mit ausreichender Lichtzufuhr versorgt. Die hohe Lichtausgangsleistung sorgt für absolut weißes Licht >5600°K und somit für detailgetreue Farbwiedergabe.

Unsere spezielle Lampenkonstruktion mit geringster Wärmeentwicklung führt zu absolut kaltem Licht und verhindert eine thermische Beschädigung der Lichtleiter.

Weitere Vorteile: Geringe Luftverwirbelungen, geringe Geräuschentwicklung, umweltfreundliche Lampe, einfachster Lampenwechsel.

Technische Daten

Elektr. Versorgung:	110-230VAC/50-60Hz Weltnetzteil
Farbtemperatur:	> 5600° K
Maße (B x H x T):	355 x 110 x 320 mm
Gewicht:	ca. 11,5 kg

Zubehör

Lampe XT 209/00: 300 Watt Xenon

nopa light xenon 300 W

Description XT 210/00

The nopalight xenon 300 watt light source can be used for all occasions particularly where strong illumination or a video recording is necessary.

All modern video camera automatic shutters are supplied with sufficient light. The high light output ensures absolute white light > 5600° K and thus detail fidelity in colour reproduction.

Our special lamp construction which has the lowest of heat generation leads to absolute cold light and prevents thermal damage to the light conductor.

Further advantages are low air turbulence, low noise level, environmentally friendly lamp and very easy bulb replacement.

Technical data

Power supply:	110-230VAC/50-60Hz world power supply
Colour temperature:	> 5600° K
Measurements (W x H x D):	355 x 110 x 320 mm
Weight:	approx. 11,5 kg

Accessories

Bulb XT 209/00: 300 Watt Xenon

nopa® cam digital camera system

immersible soakable

PAL/SECAM		
XT 301/00	=	XT 310/00 Netzka- bel/mains cord
		XT 320/01 Kamera- kopf inkl. Kabel 3,8 m, einlegbar camera head incl. cable 3,8 m, immersible
		XT 320/02 Kamera- prozessor / camera control unit
		XT 344/02 Kabel/cable S-VHS
		XT 346/00 Kabel/cable BNC
NTSC		
XT 301/01	=	XT 310/00 Netzka- bel/mains cord
		XT 320/03 Kamera- kopf inkl. Kabel 3,8 m, einlegbar camera head incl. cable 3,8 m, immersible
		XT 320/04 Kamera- prozessor/camera control unit
		XT 344/00 Kabel/cable S-VHS
		XT 346/00 Kabel/cable BNC



Beschreibung XT 301/00 / XT 301/01

nopa cam m ist die konsequente Weiterentwicklung unseres Kamerasystems. Neben allen früheren Funktionen wurden weitere Spezialfunktionen realisiert. Eine integrierte Steuerung externer Geräte (Videorecorder, Drucker) sowie die Lichtverstärkung können mittels zwei Funktionstasten direkt am Kamerakopf aktiviert werden.

Die Kamera ist mit digitaler Kontrast- und Farbsteuerung ausgestattet. Ebenfalls verfügt sie über einen digitalen anti-moiré Filter für den Gebrauch mit flexiblen Endoskopen.

Die Kamera arbeitet optimal mit starren wie auch flexiblen Endoskopen. Selbstverständlich ist der Kamerakopf einlegbar.

Technische Daten

XT 301/00 PAL - XT 301/01 NTSC

CCD Sensor:	1/3" Chip
Video-Auflösung:	750 horizontale Bildlinien
Minimale Beleuchtung:	0,9 Lux
Video-Ausgang:	FBAS oder Y/C (S-VHS)
Elektr. Versorgung:	100/115VAC und 230/240VAC
Gewicht:	2 kg

Weiteres Zubehör

XT 301/02 Kamera mit C-Mount Gewinde PAL
 XT 301/03 Kamera mit C-Mount Gewinde NTSC
 XT 306/00 Bildteiler

XT 361/40 Zoom Adapter 15 - 25 mm
 XT 361/50 Zoom Adapter 25 - 40 mm
 verwendbar mit XT 301/02 und XT 301/03

Description XT 301/00 / XT 301/01

nopa cam m is the consequent improvement of our camera system. Besides all the previous functions further special functions have been realized. An integrated control of peripheral devices (VCR, printer), as well as the Gain Control can be operated with the help of two buttons directly from the camera head.

Our camera is equipped with digital contrast and colour control and a digital anti-moiré filter for use with flexible endoscopes.

The camera serves both rigid and flexible endoscopes optimally. Of course the camera head is fully immersible.

Technical data

XT 301/00 PAL - XT 301/01 NTSC

CCD sensor:	1/3" Chip
Video resolution:	750 horizontal lines
Minimal illumination:	0,9 Lux
Video output:	FBAS or Y/C (S-VHS)
Power supply:	100/115VAC and 230/240VAC
Weight:	2kg

Optional accessories

XT 301/02 camera with C-mount adapter PAL
 XT 301/03 camera with C-mount adapter NTSC
 XT 306/00 beam splitter

XT 361/40 Zoom adapter 15 - 25 mm
 XT 361/50 Zoom adapter 25 - 40 mm
 to use with XT 301/02 and XT 301/03

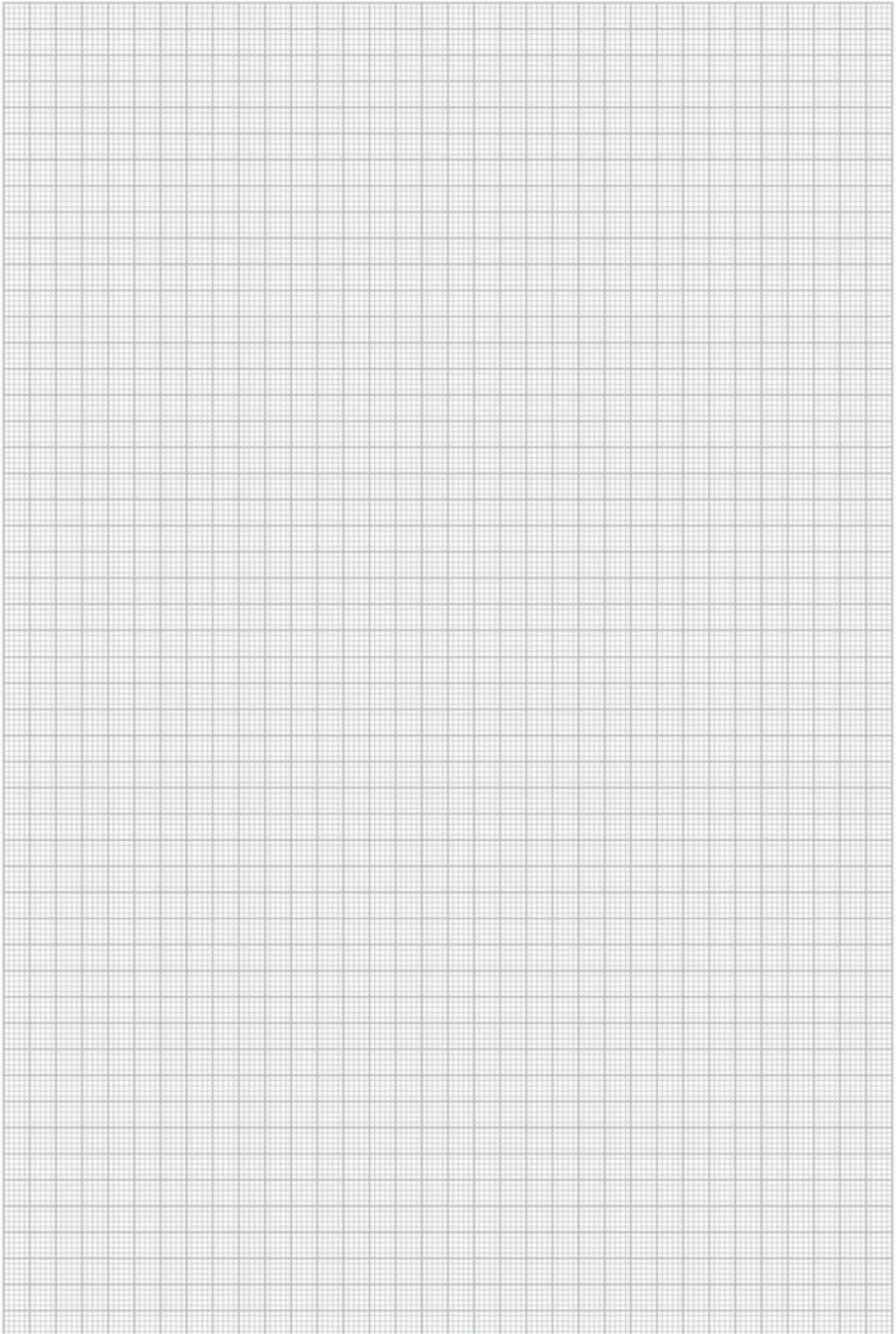

nopa® cam digital camera system

immersible soakable 3 - chip

PAL/SECAM

XT 305/00	=	XT 310/00	Netzkabel/mains cord
		XT 320/05	Kamerakopf inkl. Kabel 4,0 m, einlegbar/ camera head incl. cable 4,0 m, immersible
		XT 330/05	Kameraprozessor/camera control unit
		XT 340/05	Objektiv/Objective lens
		XT 344/05	Kabel/cable S-VHS
		XT 365/25	Adapter, Optomech. Microfocus 28 mm (C-Mount)

NTSC

XT 305/01	=	XT 310/00	Netzkabel/mains cord
		XT 325/05	Kamerakopf inkl. Kabel 4,0 m, einlegbar/ camera head incl. cable 4,0 m, immersible
		XT 335/05	Kameraprozessor/camera control unit
		XT 340/05	Objektiv/Objective lens
		XT 344/05	Kabel/cable S-VHS
		XT 365/28	Adapter, Optomech. Microfocus 28 mm (C-Mount)



Beschreibung XT 305/00 / XT 305/01

Das nopa cam camera system future 500 ist ein hochentwickeltes 3-Chip Kamerasystem und für alle endoskopischen Eingriffe einsetzbar.

Ausgezeichnete Bildqualität, scharfe Bildzeichnung und Klarheit werden durch die drei 1/3" CCD-Chips gewährleistet.

Die optimale Bilddarstellung aufgrund eines hochempfindlichen Mikro-Linsen-Chip sowie einer äußerst schnellen Blende wird auch unter schwierigsten Beleuchtungsbedingungen sichergestellt. Der leichte, kompakte Kamerakopf ist äußerst ergonomisch und einlegbar. Alle Adapter und Coupler mit einem C-Mount-Gewinde können angeschlossen werden. Der automatische Weißabgleich wird durch Schalldruck aktiviert und ist im Memory gespeichert.

Zusätzlich bietet das System eine "window"-Funktion um unter extremen Lichtverhältnissen eine gute Bilddarstellung zu garantieren. Größe und Einstellung dieses Spezial-Focus werden über den Druckschalter aktiviert und auf dem Monitor angezeigt.

Aufgrund des hohen Automatisierungsstandards der nopa cam future 500 ist das Kamerasystem sehr bedienerfreundlich. Kamerakopf und Kabel sind einlegbar.

Technische Daten

XT 305/00 PAL - XT 305/01 NTSC

CCD Sensor:	3 x 1/3" Chip (3 x 440000 pixel)
Video-Auflösung:	über 750 Linien
Elektronische Blende:	max. 1/2000000 sec.
Minimale Beleuchtung:	3 Lux F1.4
Video Ausgang:	FBAS, Y/C (S-VHS), RGB
Elektr. Versorgung:	110/115VAC - und 230/240VAC
Gewicht:	3,5 kg

Weiteres Zubehör

XT 365/15	Adapter optomechanisch microfocus 15 mm
XT 365/21	Adapter optomechanisch microfocus 21 mm
XT 365/35	Adapter optomechanisch microfocus 35 mm
XT 364/10	Microfocus-Adapter, flexibel Pentax
XT 366/10	Microfocus-Adapter, flexibel Olympus
XT 368/10	Microfocus-Adapter, flexibel Fujinon

Bei Bestellung bitte Netzspannung angeben.

Description XT 305/00 / XT 305/01

The nopa cam camera system future 500 is a highly developed three chip camera system which can be used for all operations performed with endoscopes. Excellent picture quality, sharp picture delineation and clarity are guaranteed by the three 1/3" CCD chips.

Optimal picture presentation is ensured by a highly sensitive micro-lens chip with an extremely rapid diaphragm even under difficult lighting conditions. The light, compact camera head is ergonomic and immersible. All adapters and couplings with a C-mount thread can be connected. The automatic white compensation is activated by press button and is stored in the memory.

The system additionally offers a "window" function to ensure a good picture representation under extreme lighting conditions. The magnitude and setting of this special focus are activated by press button and displayed on the monitor screen.

The nopa cam future 500's high standard of automatic operation makes this camera system extremely easy to operate. The camera head and cable can be immersed.

Technical data

XT 305/00 PAL - XT 305/01 NTSC

CCD sensor:	3 x 1/3" chip (3x 440000 pixel)
Video resolution:	more than 750 lines
Electronic shutter:	max. 1/2000000 sec.
Minimal illumination:	3 Lux F1.4
Video output:	FBAS, Y/C (S-VHS), RGB
Power supply:	110/115VAC - and 230/240VAC
Weight:	3,5 kg

Optional accessories

XT 365/15	Adapter optomechanical microfocus 15 mm
XT 365/21	Adapter optomechanical microfocus 21 mm
XT 365/35	Adapter optomechanical microfocus 35 mm
XT 364/10	Microfocus-adapter, flexible Pentax
XT 366/10	Microfocus-adapter, flexible Olympus
XT 368/10	Microfocus-adapter, flexible Fujinon

Please indicate the voltage when placing the order.

Gelenkarmsystem mit zentraler Schnellfixierung
 Articulated arm with quick central fixation
 Sistema de brazo articulado con fijación rápida central
 Système de bras articulé avec fixage rapide central
 Sistema a braccio articolato con fissaggio rapido centrale

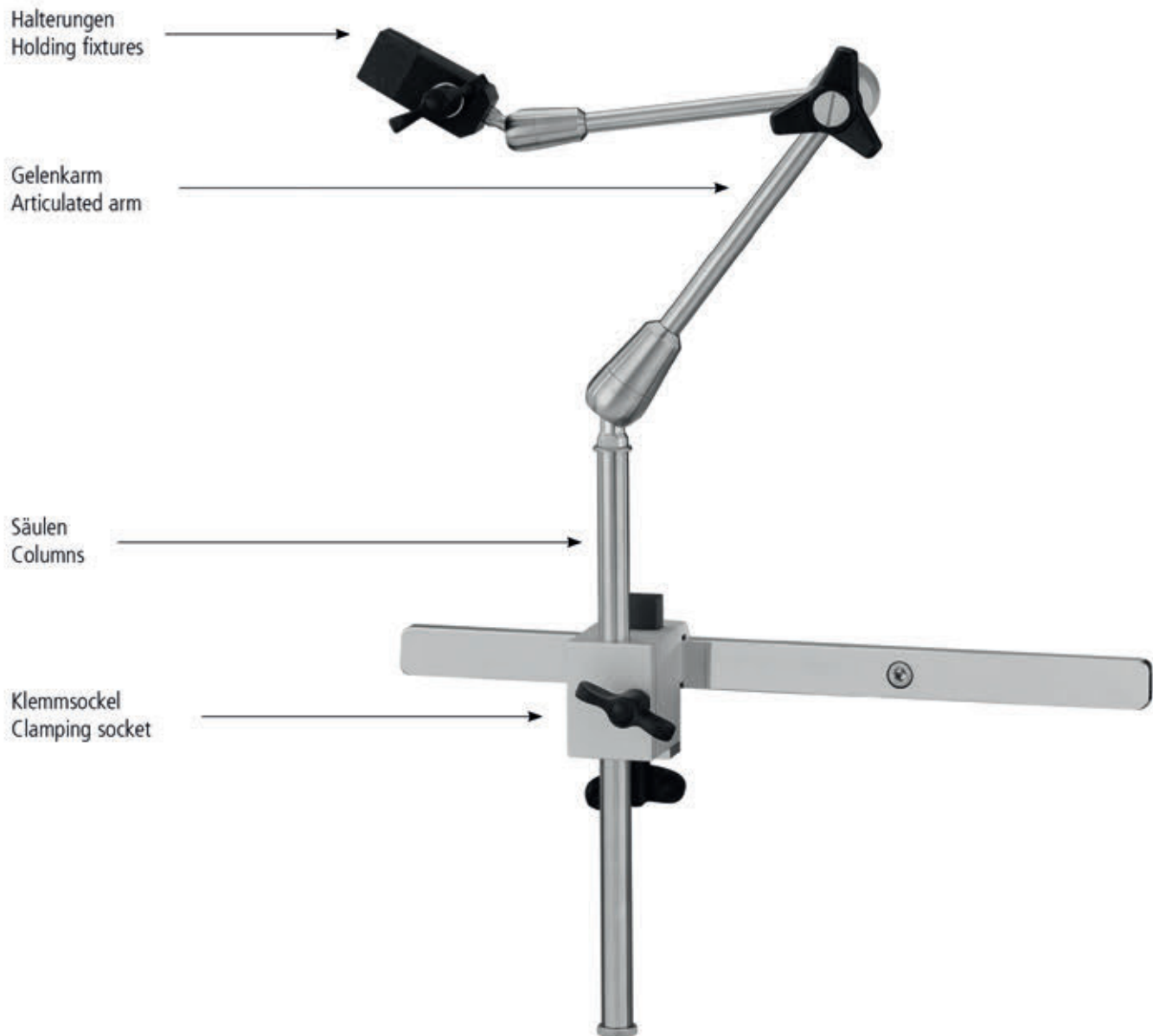

Komplett kurz / short complete

XU 650/01 = XU 650/13
 XU 650/40
 XU 651/01
 XU 651/12

Komplett lang / long complete

XU 650/02 = XU 650/13
 XU 650/55
 XU 651/02
 XU 651/12

Zubehör auf Seite 343
 Accessories on page 343

Gelenkarmsystem mit zentraler Schnellfixierung
 Articulated arm with quick central fixation
 Sistema de brazo articulado con fijación rápida central
 Système de bras articulé avec fixation rapide central
 Sistema a braccio articolato con fissaggio rapido centrale

**Halterungen
 Holders**



XU 650/11
 Kombi Instrumentenhalter
 Combined Instrument holder



XU 650/12
 Ø 4 mm Optikhalter
 Ø 4 mm Optic holder



XU 650/13
 Ø 5 mm/10 mm Optikhalter
 Ø 5 mm/10 mm Optic holder



XU 650/14
 Ø 8 mm Optikhalter
 Ø 8 mm Optic holder

**Gelenkarme
 Articulated arms**

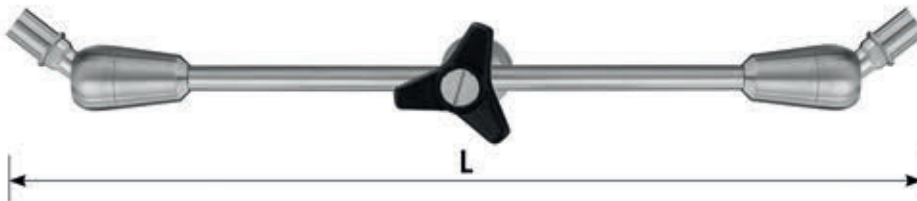

XU 650/40
 L = 400 mm M8/M12x1 Ø 16 mm

XU 650/55
 L = 550 mm M8/M12x1 Ø 16 mm

**Säulen
 Columns**



XU 651/01 Ø 16 mm 300 mm
 XU 651/02 Ø 16 mm 400 mm



XU 651/03
 Ø 16 mm 450 mm x 100 mm



XU 651/04
 Ø 16 mm 266 x 300 x 116 mm

**Klemmsockel
 Clamping socket**



XU 651/11
 Universalsockel
 Universal clamp



XU 651/12
 Schienensockel
 Rails clamping socket



XU 651/13
 Isolierter Schienensockel
 Insulated rails clamping socket

1
3
5
7
18

Inhaltsverzeichnis

	Seite		Seite
A		BERNHARD, Tuchklemmen	66
Adapter	333	Besteck, Krampfader-	203
ADSON, selbsthaltende Wundsperrerr	196,197	BETHUNE, Rippenscheren	237
ADSON, Arterienklemmen	53	BEYER, Hohlmeißelzangen	224
ADSON, Hartmetallpinzetten TUC	86	BIEMER, feine Wundhaken	253
ADSON, Pinzetten	76,77	BIEMER, Gefäß-Clips	258
ADSON, Saugrohre	216	Bi-Koagulations-Pinzetten	331
ADSON-ANDERSON, selbsthaltende Wundsperrerr	196	BILLROTH, Wundhaken	178
ADSON-BABY, Arterienklemmen	53	BIRKETT, Präparier- und Ligaturklemmen	65
ADSON-BABY, selbsthaltende Wundsperrerr	198	BONNEY, Hartmetallpinzetten TUC	87
ADSON-BROWN, Pinzetten	77	BOYNTON, Hartmetallnadelhalter TUC	149
ADSON-MICRO, Pinzetten	76	BOZEMANN, Hartmetallnadelhalter TUC	145
ADSON-TOENNIS, Gefäßscheren	102	BRIDGE, Präparier- und Ligaturklemmen	62
ADSON-TOENNIS-DELICATE, Hartmetallscheren TUC	127	BRODIE, Sonden	202
Adventitia, Mikroscheren	111,113	BROM, feine Wundhaken	252
Akku / Ladegeräte	221	Bronchusklemmen	58,297
Akku Bohrapparat	219	BROPHY (SULLIVAN), feine Scheren	105
ALEXANDER, Rippenraspatorien	235	BROPHY, Pinzetten	81
ALLIS, Gewebefasszängchen	38	BROWN-ADSON, Pinzetten	77
ALLIS-ADAIR, Gewebefasszängchen	38	BRUNNER, Rippenscheren	238
ALLIS-BABY, Gewebefasszängchen	38	Bulldogklemmen	40,41
ALLISON, Lungenspatel	255	BURFORD, Rippensperrerr	250
ALM, selbsthaltende Wundsperrerr	194	BYRD, Saugrohre	214
Anatomiescheren	104		
ANDERSON-ADSON, selbsthaltende Wundsperrerr	196	C	
ANDREWS-PYNCHON, Saugrohre	213	CAIRNS, Arterienklemmen	50
ANKENEY, Rippensperrerr	242,243	CARMALT-ROCHESTER, Arterienklemmen	55
Anlegezangen	41	CARREL, Arterienklemmen	44
Anschlusskabel	326	CARROLL, Hartmetallnadelhalter TUC	142
ARRUGA, Hartmetallnadelhalter TUC	149	CARTILAGE-MARTIN, Scheren	104
Arterienklemmen, grazil	50	CASTANEDA, Atrauma-Klemmen	294
Atrauma Bulldogklemmen	260-263	CASTANEDA, Rippensperrerr	249
Atrauma-Klemmen	264-296	CASTROVIEJO, Hartmetallmikronadelhalter TUC	152,153
Atraumatische Pinzetten	84	CASTROVIEJO, Mikronadelhalter	160
Atriumhaken	256	CHAPUT, Arterienklemmen	42
Aurikelklemmen	57	CHURCH, Gefäßscheren	103
AUSTIN, Knüpfpinzetten	82	CLASSON, Gefäßscheren	103
		CLEVELAND, Knochensplitterzangen	230
B		CLEVELAND-GARDNER, Knochensplitterzangen	229
BABCOCK, Darmfasszangen	39	Clips	257-259
BABY-ADSON, Arterienklemmen	53	COLLER, Arterienklemmen	47
BABY-ADSON, selbsthaltende Wundsperrerr	198	COLLIN, Skalpellgriffe	132
BABY-CRILE-WOOD, Hartmetallnadelhalter TUC	144	CONE, selbsthaltende Wundsperrerr	198
BABY-MIXTER, Präparier- und Ligaturklemmen	61	CONVERSE, Hartmetallnadelhalter TUC	143
BABY-OVERHOLT, Präparier- und Ligaturklemmen	51	COOLEY, Atrauma-Klemmen	285-288,291
BABY-POOLE, Saugrohre	214	COOLEY, Atriumhaken	256
BABY-SATINSKY, Vena-Cava Klemmen	298	COOLEY, Dilatatore	299
BABY-SENN-MILLER, feine Wundhaken	176	COOLEY, Gefäßdilatore	204
BABY-WEITLANER, selbsthaltende Wundsperrerr	195	COOLEY, Rippensperrerr	249
BACKHAUS, Tuchklemmen	67	COOLEY, Saugrohre	215
BADGLEY, Rippensperrerr	240	COOLEY-DERRA, Atrauma-Klemmen	289
BAILEY, Rippenkontraktoren	254	COOLEY-STRUCK, Atriumhaken	256
BAILEY-BABY, Rippenkontraktoren	254	Coronar-Scheren	101
BAILEY-GIBBON, Rippenkontraktoren	254	CORWIN, Hartmetalldrahtzangen TUC	151
BAINBRIDGE, Arterienklemmen	55	CORYLLOS, Rippenscheren	237
BAINBRIDGE, Atrauma-Klemmen	268	CORYLLOS, Wundhaken	192
BALL & SOCKET, Tuchklemmen	67	COTTLE KAZANJIAN, Knochensplitterzangen	229
BALLENGER-FOERSTER, Schwammzangen	168	COUPLAND, Saugrohre	214
BARRAQUER, Mikronadelhalter mit Rundgriff	156	CRAFOORD, Bronchusklemmen	58
BARRAQUER-TROUTMAN, Mikronadelhalter mit Rundgriff	156	CRAFOORD, Scheren	104
BECK, Atrauma-Klemmen	283,289	CRAFOORD-SELLORS, Aurikelklemmen	57
BECK-LUETHY, Hartmetallnadelhalter TUC	150	CRILE, Arterienklemmen	47
BENGOLEA, Arterienklemmen	56	CRILE, feine Wundhaken	252
		CRILE-RANKIN, Arterienklemmen	47

	Seite		Seite
CRILE-WOOD, Hartmetallnadelhalter TUC	144	F	
CRILE-WOOD-BABY, Hartmetallnadelhalter TUC	144	Face-Lift-Scheren TUC	127
CUSHING, feine Wundhaken	172,174,252	FARRELL, Watteträger	202
CUSHING, Hartmetallpinzetten TUC	86	Fasszangen Endoskopie	307-312
CUSHING, Pinzetten	80	FAVALORO, Gefäßscheren	101
CUSHING, Spinalhaken	176	FEIN, Watteträger	203
CUSHING-TAYLOR, Hartmetallpinzetten TUC	86	Feine Arterienklemmen	45
D		Feine Scheren	105-109
DALE, Atrauma-Klemmen	282	Feine Wundhaken	172-176,252,253
DANDY, Arterienklemmen	54	FERGUSSON, Saugrohre	216
DANDY, Gefäßscheren	101	FINOCCHIETTO, Hartmetallnadelhalter TUC	145
DARDIK, Atrauma-Klemmen	290	FINOCCHIETTO, Rippensperrerr	241,248
Darmfasszangen	39	FINOCCHIETTO, Scheren	104
Darmscheren	104	FINOCCHIETTO-BABY, Rippensperrerr	241
DAVIDSON, Wundhaken	193	FINSEN, selbsthaltende Wundsperrerr	194
DAVIS, Gefäßspatel	251	FISCH, feine Wundhaken	253
DAVIS-RAGNELL, feine Wundhaken	176	FOERSTER-BALLENGER, Schwammzangen	168
DE BAKEY, Atrauma Bulldogklemmen	260	FRANKENFELDT, Fasszange	207
DE BAKEY, Atrauma-Klemmen	267,269-273,275,279,284,295	FRAZIER, Saugrohre	216
DE BAKEY, Atraumatische Pinzetten	84	FRENCH-EYE-RYDER, Hartmetallnadelhalter TUC	141
DE BAKEY, Gefäßdilatoren	205	FRYKHOLM, Hohlmeißelzangen	227
DE BAKEY, Gefäßscheren	99,102	FULTON, Gefäßscheren	103
DE BAKEY, Hartmetallnadelhalter TUC	140	G	
DE BAKEY, Hartmetallpinzetten TUC	87	GARRETT, Gefäßdilatoren	204
DE BAKEY, Hartmetallscheren TUC	123	Gefäßinstrumente und Sonden	199-209
DE BAKEY, Rippensperrerr	245,246	Gefäßscheren	99-103
DE BAKEY, Saugrohre	213	Gefäßstripper	206
DE BAKEY-BAHNSON, Atrauma-Klemmen	275	GEISSENDOERFER-OVERHOLT, Arterienklemmen	51
DE BAKEY-CAROTIS, Atrauma Bulldogklemmen	262	Gelenkarmsystem	342,343
DE BAKEY-HESS, Gefäß-Clips	259	GEMINI, Präparier- und Ligaturklemmen	63
DE BAKEY-MOSQUITO, Atrauma-Klemmen	264	GERALD, Pinzetten	80
DE BAKEY-PEAN, Atrauma-Klemmen	265	Gewebefasszängchen	38
DE BAKEY-RANKIN, Atrauma-Klemmen	264	GIERTZ-STILLE, Rippenscheren	238
DE BAKEY-SATINSKY, Atrauma Bulldogklemmen	262	GILLIES, feine Wundhaken	253
DE MARTEL-POTTS, Gefäßscheren	102	GILLIES, Hartmetallnadelhalter TUC	146
DEAVER, Wundhaken	187-189	GILLIES, Hartmetallpinzetten TUC	85
DERF, Hartmetallnadelhalter TUC	143	GIL-VERNET, feine Wundhaken	175
DERRA, Atrauma-Klemmen	282	GLOVER, Atrauma Bulldogklemmen	261
DESMARRES, feine Wundhaken	174	GLOVER, Atrauma-Klemmen	283
DIEFFENBACH, Bulldogklemmen	41	GLUCK, Rippenscheren	237
DIETRICH, Hartmetallmikronadelhalter TUC	153	GOLDMAN-FOX, Hartmetallscheren TUC	127
DIETRICH-HEGEMANN, Gefäßscheren	100	GORNEY, Präparierscheren	97
DIETRICH, Atrauma-Klemmen	281	Grazile Arterienklemmen	50
Dilatoren	299	GREEN-SENN, feine Wundhaken	173
Dilatoren, Gefäß-	204,205	GREGORY, Atrauma-Klemmen	281
Dissection, Mikroscheren	111,113	GREGORY-SOFT, Atrauma Bulldogklemmen	263
DIXON-LOVELACE, Arterienklemmen	54	GROSS-MAIER, Kornzangen	166,167
DOYEN, Rippenraspatorien	235	H	
DOYEN, Sonden	201	HAIGHT, Rippensperrerr	239
DOYEN, Tuchklemmen	66	Haken, Spinal-	176
DOYEN, Wundhaken	185	HALSEY, Hartmetallnadelhalter TUC	143
Drahtzangen	222,223	HALSTED, Arterienklemmen	46
Drahtzangen mit Hartmetalleinsätzen TUC	151	HALSTED-MOSQUITO, Arterienklemmen	45
DUNHILL, Arterienklemmen	50	HARKEN, Atrauma-Klemmen	276
DUVAL, Darmfasszangen	39	HARKEN, Vena-Cava Klemmen	298
E		HARRINGTON, Wundhaken	185
easyClean	306-309	HARTMANN, Arterienklemmen	44
ECHLIN, Hohlmeißelzangen	227	Hartmetalleinsatzplättchen mit Pyramidenprofil	136,137
EISELSBERG-MATHIEU, Hartmetallnadelhalter TUC	150	HEGAR, Dilatoren	208,209
Elektroden	327,328	HEGAR-OLSEN, Hartmetallnadelhalter TUC	146
Elektroden mit Absaugung	314-317,320	HEGEMANN-DIETRICH, Gefäßscheren	100
Elektroden/Saugen/Spülen/Kanülen/Trokare	314-325	HEISS, Arterienklemmen	58
ENGL. MODELL, Tuchklemmen	66	HERTZLER, Rippensperrerr	240
EUFRATE PASQUE, Hartmetallnadelhalter TUC	141	Herz / Thorax	233-299
EWALD, Pinzetten	77		

	Seite		Seite
HF-Zubehör	326-331	L	
Hohlmeißelzangen	224-228	LAMBERT-KAY, Atrauma-Klemmen	275
HOPKINS-JOHNS, Anlegezange	41	LAMBOTTE, Rippenraspatorien	236
HOPKINS-JOHNS, Bulldogklemmen	41	LANDOLT, feine Scheren	106
HOPKINS-JOHNS, Präparier- und Ligaturklemmen	60	LANE, chirurgische Pinzetten	79
HORNE-JOBSON, Watteträger	203	LANE, Tuchklemmen	66
HÖSEL, Hartmetallnadelhalter TUC	149	LANGENBECK, Hartmetallnadelhalter TUC	150
HOSPITAL-PROVIDENCE, Arterienklemmen	46	LANGENBECK, Wundhaken	180
I		LANGENBECK-DELICATE, Hartmetallnadelhalter TUC	150
I.M.A. MAMMARIA, Rippensperrerr	239	LANGENBECK-KOCHER, Wundhaken	181
Instrumente für Laparoskopie / Thorax	306-313	LANGENBECK-MINI, feine Wundhaken	173
Irisscheren	107	LANGENBECK-RYDER, Hartmetallnadelhalter TUC	150
ISRAEL, Wundhaken	179	LAWRENCE, Präparier- und Ligaturklemmen	62
J		LEBSCHKE, Rippenscheren	238
JACOBSON, Hartmetallmikronadelhalter TUC	152	LEES, Atrauma-Klemmen	278
JACOBSON, Hartmetallnadelhalter TUC	142	LEKSELL-STILLE, Hohlmeißelzangen	226
JACOBSON, Mikronadelhalter	160	LELAND-JONES, Atrauma-Klemmen	268
JANSEN, selbsthaltende Wundsperrerr	194	LERICHE, Arterienklemmen	46
JAVID, Atrauma-Klemmen	285	LEXER, Hartmetallscheren TUC	124
JEWELER, Hartmetallpinzetten TUC	85	LEXER, Präparierscheren	97
JOBSON-HORNE, Watteträger	203	LICHTENBERG, Hartmetallnadelhalter TUC	149
JOHNS-HOPKINS, Präparier- und Ligaturklemmen	60	LINCOLN, Gefäßscheren	103
JOHNS-HOPKINS, Anlegezange	41	LISTER, Hartmetallscheren TUC	128
JOHNS-HOPKINS, Bulldogklemmen	41	LISTON, Knochensplitterzangen	229,232
JONES, Tuchklemmen	66	LISTON-KEY, Knochensplitterzangen	231
JOSEPH, Präparierscheren	98	LITTAUER-LISTON, Knochensplitterzangen	229
K		LITTLER, feine Scheren	105
KADER, Wundhaken	191	LOCKHART-MUMMERY, Sonden	202
KALT, Hartmetallmikronadelhalter TUC	153	LORNA, Tuchklemmen	67
Kaltlichtkabel	332	LOTH-KLINKENBERGH, Gefäßscheren	103
Kaltlichtquellen	332-338	LOVELACE, Lungenfasszangen	297
Kameras	339-341	LOVELACE-DIXON, Arterienklemmen	54
KANTROWITZ, Präparier- und Ligaturklemmen	63	LUETHY-BECK, Hartmetallnadelhalter TUC	150
Kanülen und Saugrohre	211-216	Luft Bohraparat	219
KAYE, Face-Lift-Scheren TUC	127	Lungenfasszangen	297
KELLY, Arterienklemmen	47	Lungenlappenscheren	104
KELLY, Wundhaken	186	Lungenspatel	255
KELLY-RANKIN, Arterienklemmen	47	M	
KILNER (RAGNELL), Präparierscheren	98	MARKWALDER, Knochensplitterzangen	229
KILNER, feine Wundhaken	253	MARQUARDT, Hohlmeißelzangen	224
KILNER, Hartmetallnadelhalter TUC	143	MARTIN, Wundhaken	184
Klemmen	35-68	MARTIN-CARTILAGE, Scheren	104
Klemmen, Aurikel-	57	MASSON, Hartmetallnadelhalter TUC	145
Klemmen, Bronchus-	58,297	MATHIEU, Hartmetallnadelhalter TUC	147
Klemmen, Bulldog-	40,41	MATHIEU-DELICATE, Hartmetallnadelhalter TUC	147
Klemmen, Schlauch-	68	MATHIEU-EISELSBERG, Hartmetallnadelhalter TUC	150
Klemmen, Tuch-	66,67	MATHIEU-RYDER, Hartmetallnadelhalter TUC	148
KLINIKUM BERLIN, Schlauchklemmen	68	MATHIEU-RYDER-VASCULAR, Hartmetallnadelhalter TUC	148
KLINKENBERGH-LOTH, Gefäßscheren	103	MATSON, Rippenraspatorien	235
Knocheninstrumente	217-232	MAYFIELD, Hohlmeißelzangen	224
Knochenscheren	237,238	MAYO, Hartmetallscheren TUC	119
Knochensplitterzangen	229-232	MAYO-HEGAR, Hartmetallnadelhalter TUC	140
Knorpelscheren	104	MAYO-HEGAR-DELICATE, Hartmetallnadelhalter TUC	140
Knüpfpinzetten mit Plateau	82,83	MC INDOE, Knochensplitterzangen	230
KOCHER, Wundhaken	177,182	MC INDOE, Pinzetten	77
KOCHER-DELICATE, Arterienklemmen	50	MC INDOE, Scheren	104
KOCHER-LANGENBECK, Wundhaken	181	MEEKER, Präparier- und Ligaturklemmen	53
KOCHER-OCHSNER, Arterienklemmen	49	MEHDORN, Gefäß-Clips	258
KOERTE, Wundhaken	178,189	METZENBAUM, Hartmetallnadelhalter TUC	147
Krampfaderbesteck	203	METZENBAUM, Hartmetallscheren TUC	121,122
KRAYENBÜHL, feine Wundhaken	252	METZENBAUM-DELICATE, Hartmetallscheren TUC	124-126
KROENLEIN, Arterienklemmen	43	METZENBAUM-DELICATE, Präparierscheren	96
		METZENBAUM-NELSON, Präparierscheren	95
		MEYERDING, feine Wundhaken	173
		MICRO-ADSON, Pinzetten	76
		MICRO-MOSQUITO, Arterienklemmen	45

	Seite		Seite
MICRO-RYDER, Hartmetallnadelhalter TUC	141	Pinzetten, Knüpf- mit Plateau	82,83
MICROVASCULAR, Hartmetallnadelhalter TUC	141	Pinzetten, Mikro-	82,83
Mikro-Nadelhalter	160,161	PLESTER, Saugrohre	216
Mikro-Nadelhalter mit Hartmetalleinsätzen	152,153	POOLE, Saugrohre	214
Mikro-Nadelhalter mit Rundgriff	156-159	POOLE-BABY, Saugrohre	214
Mikropinzetten	82,83	POTTS, Atrauma-Klemmen	266
Mikroscheren	110-116	POTTS-DE MARTEL, Gefäßscheren	102
Mikroscheren, Adventitia	111,113	POTTS-SMITH, Gefäßscheren	99,101
Mikroscheren, Dissection	111,113	POTTS-SMITH, Hartmetallmikronadelhalter TUC	153
Mikroscheren, Nerve	113	POTTS-SMITH, Hartmetallpinzetten TUC	85
MIKULICZ, Wundhaken	186	POTTS-SMITH, Hartmetallscheren TUC	123
MILLER-SENN, feine Wundhaken	176	POTTS-SMITH, Pinzetten	81
MILLS, Gefäßschere	102	POTTS-SMITH, Scheren	104
MINI, Skalpellgriffe	133	Präparierscheren	95-98
MINI, Skalpellklingen	133	Präparier- und Ligaturklemmen	51-53,57,59-65
MINI-LANGENBECK, feine Wundhaken	173	PRATT, Fistelsonden	202
MIXTER, Präparier- und Ligaturklemmen	61,62	PRESBYTERIAN, Schlauchklemmen	68
MIXTER-BABY, Präparier- und Ligaturklemmen	61	PRICE-THOMAS, Bronchusklemmen	297
MIXTER-O'SHAUGNESSY, Präparier- und Ligaturklemmen	61	PROVIDENCE-HOSPITAL, Arterienklemmen	46
MIXTER-OVERHOLT, Präparier- und Ligaturklemmen	57	PYNCHON-ANDREWS, Saugrohre	213
MOD. BONN, feine Scheren	106		
MODELL TÜBINGEN, Wundhaken	184	R	
MOLDESTAD, feine Wundhaken	172	RAGNELL (KILNER), Präparierscheren	98
MORRIS, Wundhaken	183	RAGNELL-DAVIS, feine Wundhaken	176
MORRIS-DE BAKEY, Atrauma-Klemmen	280	RAMPLEY, Schwammzangen	169
MORSE FAVALORO, Rippensperrerr	247	RANKIN-CRILE, Arterienklemmen	47
MOSQUITO-HALSTED, Arterienklemmen	45	RANKIN-KELLY, Arterienklemmen	47
MOSQUITO-MICRO, Arterienklemmen	45	REILL, Mikronadelhalter mit Rundgriff	157
MÜLLER, Gefäß-Clips	259	Retraktoren Endoskopie	313
MUMMERY-LOCKHART, Sonden	202	REYNOLDS, Präparierscheren	98
MYRTLE-LEAF, Sonden	201	Rippenkontraktoren	254
		Rippen-Raspatorien	235,236
N		Rippenscheren	237,238
NABATOFF, Krampfaderbesteck	203	Rippensperrerr	239-250
Nadelhalter mit Hartmetalleinsätzen	140-155	ROBERTS, Arterienklemmen	58
Naht	135-161	ROCHESTER-CARMALT, Arterienklemmen	55
NEIVERT, Hartmetallnadelhalter TUC	143	ROCHESTER-PEAN, Arterienklemmen	48
NELATON, Sonden	201	ROEDER, Tuchklemmen	67
NELSON-METZENBAUM, Präparierscheren	95	ROETTGEN-RUSKIN, Hohlmeißelzangen	226
Nerve, Mikroscheren	113	RUMEL, Präparier- und Ligaturklemmen	59
Nerv-Präparierscheren	97	RUMEL-BELMONT, Tourniquet	299
NEW ORLEANS, Hartmetallnadelhalter TUC	142	RUSKIN, Hohlmeißelzangen	224,228
nopa DIAMOND, Nadelhalter	154,155	RUSKIN-LISTON, Knochensplitterzangen	230
		RYDER-FRENCH-EYE, Hartmetallnadelhalter TUC	141
O		RYDER-LANGENBECK, Hartmetallnadelhalter TUC	150
O'BRIEN, feine Scheren	106	RYDER-MATHIEU VASCULAR, Hartmetallnadelhalter TUC	148
OCHSNER, Atrauma-Klemmen	281	RYDER-MATHIEU, Hartmetallnadelhalter TUC	148
OCHSNER-KOCHER, Arterienklemmen	49	RYDER-MICRO, Hartmetallnadelhalter TUC	141
OEHLER, Hartmetallpinzetten TUC	85		
OLLIER, Wundhaken	179	S	
OLSEN-HEGAR, Hartmetallnadelhalter TUC	146	SANTULLI, Atrauma Bulldogklemmen	260
Optiken	304,305	SANVENERO, Präparierscheren	98
OVERHOLT, Präparier- und Ligaturklemmen	52	SAROT, Bronchusklemmen	58
OVERHOLT-BABY, Präparier- und Ligaturklemmen	51	SAROT, Hartmetallnadelhalter TUC	145
OVERHOLT-GEISSENDOERFER, Präparier- und Ligaturklemmen	51	SATINSKY, Atrauma-Klemmen	272,274
OVERHOLT-MIXTER, Präparier- und Ligaturklemmen	57	SATINSKY, Gefäßscheren	103
		SATINSKY, Vena-Cava Klemmen	298
P		SAUERBRUCH, Hohlmeißelzangen	227
PEAN, Arterienklemmen	43	SAUERBRUCH, Rippenscheren	237
PEAN-DELICATE, Arterienklemmen	50	SAUERBRUCH, Wundhaken	182,192
PEAN-ROCHESTER, Arterienklemmen	48	Saugrohre und Kanülen	211-216
PEERS, Tuchklemmen	67	Saug- und Spülrohre Endoskopie	318,319
PENFIELD, Spatel	251	SAWTELL-SCHNIDT, Tonsillenklemmen	55
Pinzetten	71-87	SCHAEDEL, Tuchklemmen	66
Pinzetten mit Hartmetalleinsätzen	85-87	Scheren	89-128
Pinzetten monopolar	329	Scheren mit Hartmetalleinlagen	118-128
		Scheren, Anatomie-	104

	Seite		Seite
Scheren, Darm-	104	TOHOKU-JAPAN, Tuckklemmen	67
Scheren, Knorpel-	104	Tokarhülsen und Trokare	321-325
Scheren, Lungenlappen-	104	TÖNNIS, Gefäßspatel	251
Scheren, Supercut SC	91	Tonsillenklemmen	55
Schlauchklemmen	68	Tourniquet	299
SCHMID, Gefäßspatel	251	TROUTMAN, Mikronadelhalter mit Rundgriff	157
SCHMIEDEN-TAYLOR, Gefäßscheren	102	TROUTMAN-BARRAQUER, Mikronadelhalter mit Rundgriff	156
SCHNIDT-SAWTELL, Tonsillenklemmen	55	TUBBS, Dilatatoren	299
SELLORS, Rippenkonraktoren	254	TÜBINGEN MODELL, Wundhaken	184
SELLORS-CRAFOORD, Aurikelklemmen	57	Tuckklemmen	66,67
SEMB, Bronchusklemmen	297	TUDOR-EDWARDS, Knochensplitterzangen	231
SEMB, Hohlmeißelzangen	225	TUFFIER, Arterienklemmen	42
SEMB, Knochensplitterzangen	232	TUFFIER, Rippensperrerr	240
SEMB, Rippenraspatorien	236	TUFFIER, Wundhaken	185
SEMKEN, Hartmetallpinzetten TUC	85	Tupferzangen	163-169
SEMKEN, Pinzetten	77,78	U	
SENN-GREEN, feine Wundhaken	173	UCKERMANN, Watteträger	203
SENNING (SWEDISH PATTERN), Hartmetallnadelhalter TUC	142	ULRICH, Kornzangen	165
SENN-MILLER, feine Wundhaken	176	UNIVERSAL, Hartmetallscheren TUC	128
SENN-MILLER-BABY, feine Wundhaken	176	V	
SIMON, Wundhaken	184	Vena-Cava Klemmen	298
Skalpelle	129-134	VERNET-GIL, feine Wundhaken	175
Skalpellgriffe	131-133	VOLKMANN, Wundhaken	177,178
Skalpellklingen	133,134	W	
SMITH-PETERSON, Hohlmeißelzangen	228	WALTON, feine Scheren	106
SMITH-POTTS, Gefäßscheren	99,101	WALTON-LISTON, Knochensplitterzangen	230
SMITH-POTTS, Hartmetallmikronadelhalter TUC	153	WALTON-YANKAUER, Saugrohre	213
SMITH-POTTS, Hartmetallpinzetten TUC	85	WANGENSTEEN, Hartmetallnadelhalter TUC	145
SMITH-POTTS, Pinzetten	81	WANGENSTEEN, Hartmetallpinzetten TUC	87
SMITH-POTTS, Scheren	104	Watteträger	202,203
SNITMAN, selbsthaltende Wundsperrerr	194	WEBER, Atrauma-Klemmen	277
Sonden	201,202	WEBSTER, Hartmetallnadelhalter TUC	143
Sonden und Gefäßinstrumente	199-209	WEITLANER, selbsthaltende Wundsperrerr	195
Spatel	251	WEITLANER-BABY, selbsthaltende Wundsperrerr	195
SPENCER-WELLS, Arterienklemmen	44	WELLS-SPENCER, Arterienklemmen	44
Spinalhaken	176	WERTHEIM, Hartmetallnadelhalter TUC	146
STACKE, Sonden	201	WIKSTROEM, Präparier- und Ligaturklemmen	65
STANDARD, anatomische Pinzetten	75	Wundhaken	171-198
STANDARD, chirurgische Pinzetten	75	Y	
STANDARD, Hartmetallscheren TUC	118,119	YANKAUER, Saugrohre	213
STERNUM, Hartmetalldrahtzangen TUC	151	YANKAUER-WALTON, Saugrohre	213
STEVENS, Hartmetallscheren TUC	127	Z	
STEVENS, Sehnenscheren	109	ZAUFAL-JANSEN, Hohlmeißelzangen	224
STILLE, Hohlmeißelzangen	225	ZENKER, Präparier- und Ligaturklemmen	60
STILLE-LISTON, Knochensplitterzangen	231	ZENKER, Wundhaken	190
STILLE-LUER, Hohlmeißelzangen	226	Zubehör für Bohrapparate	220
STILLE-RUSKIN, Hohlmeißelzangen	225	ZWEIFEL, Hartmetallnadelhalter TUC	150
STRATTE, Hartmetallnadelhalter TUC	145		
STRULLY, Gefäßscheren	101		
SUBRAMANIAN, Atrauma-Klemmen	296		
SUBRAMANIAN-MINIATURE, Atrauma-Klemmen	296		
Super Cut Hartmetallscheren TUC	117		
Super Cut Scheren	91		
T			
TAYLOR, Pinzetten	78,79		
TAYLOR, Spinalhaken	176		
TAYLOR-CUSHING, Hartmetallpinzetten TUC	86		
TAYLOR-SCHMIEDEN, Gefäßscheren	102		
TERRIER, Arterienklemmen	44		
Thorakoskopie	301-343		
tini Instrumente (titan-nitrid Beschichtung)	69,70		
titan instruments	37,73,93,116,139		
TOENNIS, Gefäßscheren	102		
TOENNIS, Hartmetallnadelhalter TUC	149		
TOENNIS, Präparier- und Ligaturklemmen	64		
TOENNIS-ADSON, Gefäßscheren	102		
TOENNIS-ADSON-DELICATE, Hartmetallscheren TUC	127		

Index

	Page		Page
A		BETHUNE, rib shears	237
Accessories for drills	220	BEYER, bone rongeurs	224
Accu power drill	219	Bi-Coagulation-Forceps	331
Adapter	333	BIEMER, delicate hooks	253
ADSON, dissecting and ligature forceps	53	BIEMER, vascular clips	258
ADSON, dissecting forceps tungsten TUC	86	BILLROTH, retractors	178
ADSON, forceps	76,77	BIRKETT, dissecting and ligature forceps	65
ADSON, selfretaining retractors	196,197	Bone cutting forceps	229-232
ADSON, suction tubes	216	Bone instruments	217-232
ADSON-ANDERSON, selfretaining retractors	196	Bone rongeurs	224-228
ADSON-BABY, dissecting and ligature forceps	53	Bone shears	237,238
ADSON-BABY, selfretaining retractors	198	BONNEY, dissecting forceps tungsten TUC	87
ADSON-BROWN, tissue forceps	77	BOYNTON, needle holders tungsten TUC	149
ADSON-MICRO, dressing and tissue forceps	76	BOZEMANN, needle holders tungsten TUC	145
ADSON-TOENNIS, scissors for vascular and neuro surgery	102	BRIDGE, dissecting and ligature forceps	62
ADSON-TOENNIS-DELICATE, scissors tungsten carbide TUC	127	BRODIE, probes	202
Adventitia, micro scissors	111,113	BROM, delicate hooks	252
Air power drill	219	Bronchus clamps	297
ALEXANDER, costal periosteotomes	235	Bronchus forceps	58
ALLIS, tissue seizing forceps	38	BROPHY (SULLIVAN), fine scissors	105
ALLIS-ADAIR, tissue seizing forceps	38	BROPHY, dressing and tissue forceps	81
ALLIS-BABY, tissue seizing forceps	38	BROWN-ADSON, tissue forceps	77
ALLISON, lung spatulas	255	BRUNNER, rib shears	238
ALM, selfretaining retractors	194	Bulldog Clamps	40,41
ANDERSON-ADSON, selfretaining retractors	196	BURFORD, rib spreaders	250
ANDREWS-PYNCHON, suction tubes	213	BYRD, suction tubes	214
ANKENEY, rib spreaders	242,243		
ARRUGA, needle holders tungsten TUC	149	C	
Artery forceps, delicate	50	CAIRNS, artery forceps	50
Articulated arm with quick central fixation	342,343	Cameras	339-341
Atrauma bulldog clamps	260-263	Cannulae and suction tubes	211-216
Atrauma forceps	264-296	Cardiovascular	233-299
Atrium retractors	256	CARMALT-ROCHESTER, artery forceps	55
Auricle forceps	57	CARREL, artery forceps	44
AUSTIN, tying forceps	82	CARROLL, needle holders tungsten TUC	142
		Cartilage scissors	104
B		CARTILAGE-MARTIN, scissors	104
BABCOCK, tissue seizing forceps	39	CASTANEDA, atrauma forceps	294
BABY-ADSON, ligature and dissecting forceps	53	CASTANEDA, rib spreaders	249
BABY-ADSON, selfretaining retractors	198	CASTROVIEJO, micro needle holders	160
BABY-CRILE-WOOD, needle holders tungsten TUC	144	CASTROVIEJO, micro needle holders tungsten TUC	152,153
BABY-MIXTER, dissecting and ligature forceps	61	CHAPUT, artery forceps	42
BABY-OVERHOLT, dissecting and ligature forceps	51	Charger / Battery	221
BABY-POOLE, suction tubes	214	CHURCH, scissors for vascular and neuro surgery	103
BABY-SATINSKY, vena-cava forceps	298	Clamps, towel	66,67
BABY-SENN-MILLER, delicate retractors	176	Clamps, tubing	68
BABY-WEITLANER, selfretaining retractors	195	CLASSON, scissors for vascular and neuro surgery	103
BACKHAUS, towel forceps	67	CLEVELAND, bone cutting forceps	230
BADGLEY, rib spreaders	240	CLEVELAND-GARDNER, bone cutting forceps	229
BAILEY, rib contractors	254	Clips	257-259
BAILEY-BABY, rib contractors	254	Cold light sources	332-338
BAILEY-GIBBON, rib contractors	254	COLLER, artery forceps	47
BAINBRIDGE, artery forceps	55	COLLIN, scalpel handles	132
BAINBRIDGE, atrauma forceps	268	CONE, selfretaining retractors	198
BALL & SOCKET, towel forceps	67	Connection cords	326
BALLENGER-FOERSTER, sponge holding forceps	168	CONVERSE, needle holders tungsten TUC	143
BARRAQUER, micro needle holders with pen-type handle	156	COOLEY, atrauma forceps	285-288,291
BARRAQUER-TROUTMAN, m. needle holders with pen-type handle	156	COOLEY, atrium retractors	256
Battery / Charger	221	COOLEY, dilators	299
BECK, atrauma forceps	283,289	COOLEY, rib spreaders	249
BECK-LUETHY, needle holders tungsten TUC	150	COOLEY, suction tubes	215
BENGOLEA, artery forceps	56	COOLEY, vascular dilators	204
BERNHARD, towel forceps	66	COOLEY-DERRA, atrauma forceps	289
		COOLEY-STRUCK, atrium retractors	256

	Page		Page
Coronary scissors	101	DOYEN, towel forceps	66
CORWIN, wire twisting forceps tungsten TUC	151	DUNHILL, artery forceps	50
CORYLLOS, retractors	192	DUVAL, tissue seizing forceps	39
CORYLLOS, rib shears	237		
Costal periosteotomes	235,236	E	
COTTLE KAZANJIAN, bone cutting forceps	229	easyClean	306-309
Cotton applicators	202,203	ECHLIN, bone rongeurs	227
COUPLAND, suction tubes	214	EISELSBERG-MATHIEU, needle holders tungsten TUC	150
CRAFOORD, bronchus forceps	58	Electrodes	327,328
CRAFOORD, scissors	104	Electrodes with suction tube	314-317,320
CRAFOORD-SELLORS, auricle forceps	57	Electrodes/Suction/Irrigation/Cannulae/Trocars	314-325
CRILE, artery forceps	47	ENGL. MODELL, towel forceps	66
CRILE, delicate hooks	252	Enterotomy scissors	104
CRILE-RANKIN, artery forceps	47	EUFRATE-PASQUE, microvascular needle holders TUC	141
CRILE-WOOD, needle holders tungsten TUC	144	EWALD, dressing and tissue forceps	77
CRILE-WOOD-BABY, needle holders tungsten TUC	144		
CUSHING, delicate hooks	172,174,252	F	
CUSHING, dissecting forceps tungsten TUC	86	Face-lift scissors TUC	127
CUSHING, dressing and tissue forceps	80	FARREL, cotton applicators	202
CUSHING, spinal retractors	176	FAVALORO, scissors for vascular and neuro surgery	101
CUSHING-TAYLOR, dissecting forceps tungsten TUC	86	FEIN, cotton applicators	203
		FERGUSSON, suction tubes	216
D		Fibre optic cable	332
DALE, atrauma forceps	282	Fine artery forceps	45
DANDY, artery forceps	54	Fine scissors	105-109
DANDY, scissors for vascular and neuro surgery	101	FINOCCHIETTO, needle holders tungsten TUC	145
DARDIK, atrauma forceps	290	FINOCCHIETTO, rib spreaders	241,248
DAVIDSON, retractors	193	FINOCCHIETTO, scissors	104
DAVIS, vascular spatulas	251	FINOCCHIETTO-BABY, rib spreaders	241
DAVIS-RAGNELL, delicate retractors	176	FINSEN, selfretaining retractors	194
DE BAKEY, atrauma bulldog clamps	260	FISCH, delicate hooks	253
DE BAKEY, atrauma forceps	267,269-273,275,279,284,295	FOERSTER-BALLENGER, sponge holding forceps	168
DE BAKEY, dissecting forceps tungsten TUC	87	Forceps	71-87
DE BAKEY, needle holders TUC	140	Forceps monopolar	329
DE BAKEY, non-traumatic vascular tissue forceps	84	Forceps with Tungsten Carbide inserts	85-87
DE BAKEY, rib spreaders	245,246	Forceps, auricle	57
DE BAKEY, scissors for vascular surgery	99,102	Forceps, bronchus	58
DE BAKEY, scissors tungsten carbide TUC	123	Forceps, micro	82,83
DE BAKEY, suction tubes	213	Forceps, non-traumatic vascular tissue	84
DE BAKEY, vascular dilators	205	Forceps, setting	41
DE BAKEY-BAHNSON, atrauma forceps	275	Forceps, suture tying with platform	82,83
DE BAKEY-CAROTIS, atrauma bulldog clamps	262	Forceps, tissue seizing	38,39
DE BAKEY-HESS, vascular clips	259	Forceps, tonsil hemostatic	55
DE BAKEY-MOSQUITO, atrauma forceps	264	FOX-GOLDMAN, scissors tungsten carbide TUC	127
DE BAKEY-PEAN, atrauma forceps	265	FRANKENFELDT, grasping forceps	207
DE BAKEY-RANKIN, atrauma forceps	264	FRAZIER, suction tubes	216
DE BAKEY-SATINSKY, atrauma bulldog clamps	262	FRENCH-EYE-RYDER, needle holders tungsten TUC	141
DE MARTEL-POTTS, scissors for vascular and neuro surgery	102	FRYKHOLM, bone rongeurs	227
DEAVER, retractors	187-189	FULTON, scissors for vascular and neuro surgery	103
Delicate artery forceps	50		
Delicate hooks	172-175,252,253	G	
Delicate retractors	176	GARRETT, vascular dilators	204
DERF, needle holders tungsten TUC	143	GEISSENDOERFER-OVERHOLT, dissecting and ligature forceps	51
DERRA, atrauma forceps	282	GEMINI, dissecting and ligature forceps	63
DESMARRES, delicate retractors	174	GERALD, dissecting and tissue forceps	80
DIEFFENBACH, bulldog clamps	41	GIERTZ-STILLE, rib shears	238
DIETRICH, micro needle holders tungsten TUC	153	GILLIES, delicate hooks	253
DIETRICH-HEGEMANN, scissors for vascular surgery	100	GILLIES, dissecting forceps tungsten TUC	85
DIETRICH, atrauma forceps	281	GILLIES, needle holders tungsten TUC	146
Dilators	299	GIL-VERNET, delicate retractors	175
Dilators, vascular	204,205	GLOVER, atrauma bulldog clamps	261
Dissecting and ligature forceps	51-53,57,59-65	GLOVER, atrauma forceps	283
Dissecting scissors	95-98	GLUCK, rib shears	237
Dissection, micro scissors	111,113	GOLDMAN-FOX, scissors tungsten carbide TUC	127
DIXON-LOVELACE, artery forceps	54	GORNEY, dissecting scissors	97
DOYEN, costal periosteotomes	235	Grasping forceps, endoscopy	307-312
DOYEN, probes	201		
DOYEN, retractors	185		

	Page		Page
GREEN-SENN, delicate retractors	173	KOERTE, retractors	178,189
GREGORY, atrauma forceps	281	KRAYENBÜHL, delicate hooks	252
GREGORY-SOFT, atrauma bulldog clamps	263	KROENLEIN, artery forceps	43
GROSS-MAIER, polypus forceps	166,167		
H		L	
HAIGHT, rib spreaders	239	LAMBERT-KAY, atrauma forceps	275
HALSEY, needle holders tungsten TUC	143	LAMBOTTE, costal periosteotomes	236
HALSTED, artery forceps	46	LANDOLT, fine scissors	106
HALSTED-MOSQUITO, artery forceps	45	LANE, tissue forceps	79
HARKEN, atrauma forceps	276	LANE, towel forceps	66
HARKEN, vena-cava forceps	298	LANGENBECK, needle holders tungsten TUC	150
HARRINGTON, retractors	185	LANGENBECK, retractors	180
HARTMANN, artery forceps	44	LANGENBECK-DELICATE, needle holders tungsten TUC	150
HEGAR, dilators	208,209	LANGENBECK-KOCHER, retractors	181
HEGAR-OLSEN, needle holders tungsten TUC	146	LANGENBECK-MINI, delicate retractors	173
HEGEMANN-DIETRICH, scissors for vascular surgery	100	LANGENBECK-RYDER, needle holders tungsten TUC	150
HEISS, artery forceps	58	LAWRENCE, dissecting and ligature forceps	62
Hemostats	35-68	LEBSCHKE, rib shears	238
HERTZLER, rib spreaders	240	LEES, atrauma forceps	278
HF-accessories	326-331	LEKSELL-STILLE, bone rongeurs	226
HÖSEL, needle holders tungsten TUC	149	LELAND-JONES, atrauma forceps	268
HOPKINS-JOHNS, bulldog clamps	41	LERICHE, artery forceps	46
HOPKINS-JOHNS, dissecting and ligature forceps	60	LEXER, dissecting scissors	97
HOPKINS-JOHNS, setting forceps	41	LEXER, scissors tungsten TUC	124
HORNE-JOBSON, cotton applicators	203	LICHTENBERG, needle holders tungsten TUC	149
HOSPITAL-PROVIDENCE, artery forceps	46	LINCOLN, scissors for vascular and neuro surgery	103
I		LISTER, scissors tungsten carbide TUC	128
I.M.A. MAMMARIA, rib spreaders	239	LISTON, bone cutting forceps	229,232
Instruments for Laparoscopy / Thorax	306-313	LISTON-KEY, bone cutting forceps	231
Iris scissors	107	LITTAUER-LISTON, bone cutting forceps	229
ISRAEL, retractors	179	LITTLER, fine scissors	105
J		Lobectomy scissors	104
JACOBSON, micro needle holders	160	LOCKHART-MUMMERY, probes	202
JACOBSON, micro needle holders tungsten TUC	152	LORNA, towel forceps	67
JACOBSON, needle holders tungsten TUC	142	LOTH-KLINKENBERGH, scissors for vascular and neuro surgery	103
JANSEN, self-retaining retractors	194	LOVELACE, lung grasping forceps	297
JAVID, atrauma forceps	285	LOVELACE-DIXON, artery forceps	54
JEWELER, dissecting forceps tungsten TUC	85	LUETHY-BECK, needle holders tungsten TUC	150
JOBSON-HORNE, cotton applicators	203	Lung grasping forceps	297
JOHNS-HOPKINS, bulldog clamps	41	Lung spatulas	255
JOHNS-HOPKINS, dissecting and ligature forceps	60	M	
JOHNS-HOPKINS, setting forceps	41	MARKWALDER, bone cutting forceps	229
JONES, towel forceps	66	MARQUARDT, bone rongeurs	224
JOSEPH, dissecting scissors	98	MARTIN, retractors	184
K		MARTIN-CARTILAGE, scissors	104
KADER, retractors	191	MASSON, needle holders tungsten TUC	145
KALT, micro needle holders tungsten TUC	153	MATHIEU, needle holders tungsten TUC	147
KANTROWITZ, dissecting and ligature forceps	63	MATHIEU-DELICATE, needle holders tungsten TUC	147
KAYE, Face-lift scissors TUC	127	MATHIEU-EISELSBERG, needle holders tungsten TUC	150
KELLY, artery forceps	47	MATHIEU-RYDER VASCULAR, needle holders tungsten TUC	148
KELLY, retractors	186	MATHIEU-RYDER, needle holders tungsten TUC	148
KELLY-RANKIN, artery forceps	47	MATSON, costal periosteotomes	235
KILNER (RAGNELL), dissecting scissors	98	MAYFIELD, bone rongeurs	224
KILNER, delicate hooks	253	MAYO, scissors tungsten carbide TUC	119
KILNER, needle holders tungsten TUC	143	MAYO-HEGAR, needle holders TUC	140
KLINIKUM BERLIN, tubing clamps	68	MAYO-HEGAR-DELICATE, needle holders TUC	140
KLINKENBERGH-LOTH, scissors for vascular and neuro surgery	103	MC INDOE, bone cutting forceps	230
KOCHER, retractors	177,182	MC INDOE, dressing forceps	77
KOCHER-DELICATE, artery forceps	50	MC INDOE, scissors	104
KOCHER-LANGENBECK, retractors	181	MEEKER, dissecting and ligature forceps	53
KOCHER-OCHSNER, artery forceps	49	MEHDORN, vascular clips	258
		METZENBAUM, needle holders tungsten TUC	147
		METZENBAUM, scissors tungsten carbide TUC	121,122
		METZENBAUM-DELICATE, dissecting scissors	96
		METZENBAUM-DELICATE, scissors tungsten carbide TUC	124-126
		METZENBAUM-NELSON, dissecting scissors	95

	Page		Page
MEYERDING, delicate retractors	173	POTTS-DE MARTEL, scissors for vascular and neuro surgery	102
Micro forceps	82,83	POTTS-SMITH, dissecting forceps tungsten TUC	85
Micro needle holders	160,161	POTTS-SMITH, dressing and tissue forceps	81
Micro needle holders with pen-type handle	156-159	POTTS-SMITH, micro needle holders tungsten TUC	153
Micro needle holders with tungsten carbide inserts TUC	152,153	POTTS-SMITH, scissors	104
Micro scissors	110-116	POTTS-SMITH, scissors for vascular surgery	99,101
MICRO-ADSON, dressing and tissue forceps	76	POTTS-SMITH, scissors tungsten carbide TUC	123
MICRO-MOSQUITO, artery forceps	45	PRATT, fistula probes	202
MICRO-RYDER, needle holders tungsten TUC	141	PRESBYTERIAN, tubing clamps	68
MICROVASCULAR, needle holders TUC	141	PRICE-THOMAS, bronchus clamps	297
MIKULICZ, retractors	186	Probes	201,202
MILLER-SENN, delicate retractors	176	Probes and vessel instruments	199-209
MILLS, scissors for vascular and neuro surgery	102	PROVIDENCE-HOSPITAL, artery forceps	46
MINI, scalpel blades	133	PYNCHON-ANDREWS, suction tubes	213
MINI, scalpel handles	133		
MINI-LANGENBECK, delicate retractors	173	R	
MIXTER, dissecting and ligature forceps	61,62	RAGNELL (KILNER), dissecting scissors	98
MIXTER-BABY, dissecting and ligature forceps	61	RAGNELL-DAVIS, delicate retractors	176
MIXTER-O'SHAUGNESSY, dissecting and ligature forceps	61	RAMPLEY, sponge holding forceps	169
MIXTER-OVERHOLT, dissecting and ligature forceps	57	RANKIN-CRILE, artery forceps	47
MOD.BONN, fine scissors	106	RANKIN-KELLY, artery forceps	47
MODELL TÜBINGEN, retractors	184	REILL, micro needle holders with pen-type handle	157
MOLDESTAD, delicate hooks	172	Retractors	171-198
MORRIS, retractors	183	Retractors, delicate	176
MORRIS-DE BAKEY, atrauma forceps	280	Retractors, endoscopy	313
MORSE FAVALORO, rib spreaders	247	Retractors, spinal	176
MOSQUITO-HALSTED, artery forceps	45	REYNOLDS, dissecting scissors	98
MOSQUITO-MICRO, artery forceps	45	Rib contractors	254
MÜLLER, vascular clips	259	Rib shears	237,238
MUMMERY-LOCKHART, probes	202	Rib spreaders	239-250
MYRTLE LEAF, probes	201	ROBERTS, artery forceps	58
N		ROCHESTER-CARMALT, artery forceps	55
NABATOFF, varicose vein probe set	203	ROCHESTER-PEAN, artery forceps	48
Needle holders with tungsten carbide inserts	140-155	ROEDER, towel forceps	67
NEIVERT, needle holders tungsten TUC	143	ROETTGEN-RUSKIN, bone rongeurs	226
NELATON, probes	201	RUMEL, dissecting and ligature forceps	59
NELSON-METZENBAUM, dissecting scissors	95	RUMEL-BELMONT, tourniquets	299
Nerve dissecting scissors	97	RUSKIN, bone rongeurs	224,228
Nerve, micro scissors	113	RUSKIN-LISTON, bone cutting forceps	230
NEW ORLEANS, needle holders tungsten TUC	142	RYDER-FRENCH EYE, needle holders tungsten TUC	141
Non-traumatic vascular tissue forceps	84	RYDER-LANGENBECK, needle holders tungsten TUC	150
nopa DIAMOND, needleholders	154,155	RYDER-MATHIEU VASCULAR, needle holders tungsten TUC	148
O		RYDER-MATHIEU, needle holders tungsten TUC	148
O'BRIEN, fine scissors	106	RYDER-MICRO, needle holders tungsten TUC	141
OCHSNER, atrauma forceps	281	S	
OCHSNER-KOCHER, artery forceps	49	SANTULLI, atrauma bulldog clamps	260
OEHLER, dissecting forceps tungsten TUC	85	SANVENERO, dissecting scissors	98
OLLIER, retractors	179	SAROT, bronchus forceps	58
OLSEN-HEGAR, needle holders tungsten TUC	146	SAROT, needle holders tungsten TUC	145
OVERHOLT, dissecting and ligature forceps	52	SATINSKY, atrauma forceps	272,274
OVERHOLT-BABY, dissecting and ligature forceps	51	SATINSKY, scissors for vascular and neuro surgery	103
OVERHOLT-GEISSENDOERFER, dissecting and ligature forceps	51	SATINSKY, vena-cava forceps	298
OVERHOLT-MIXTER, dissecting and ligature forceps	57	SAUERBRUCH, bone rongeurs	227
P		SAUERBRUCH, retractors	182,192
PEAN, artery forceps	43	SAUERBRUCH, rib shears	237
PEAN-DELICATE, artery forceps	50	SAWTELL-SCHNIDT, tonsil hemostatic forceps	55
PEAN-ROCHESTER, artery forceps	48	Scalpel blades	133,134
PEERS, towel forceps	67	Scalpel handles	131-133
PENFIELD, spatulas	251	Scalpels	129-134
PLESTER, suction tubes	216	SCHAEDEL, towel forceps	66
POOLE, suction tubes	214	SCHMID, vascular spatulas	251
POOLE-BABY, suction tubes	214	SCHMIEDEN-TAYLOR, scissors for vascular and neuro surgery	102
POTTS, atrauma forceps	266	SCHNIDT-SAWTELL, tonsil hemostatic forceps	55
		Scissors	89-128
		Scissors for vascular surgery	99-103
		Scissors with tungsten carbide inserts TUC	118-128

	Page		Page
Scissors, cartilage	104	tini instruments (titan-nitride surface coating)	69,70
Scissors, coronary	101	Tissue seizing forceps	38,39
Scissors, enterotomy	104	titan instruments	37,73,93,116,139
Scissors, fine	105-109	TOENNIS, dissecting and ligature forceps	64
Scissors, iris	107	TOENNIS, needle holders tungsten TUC	149
Scissors, lobectomy	104	TOENNIS, scissors for vascular and neuro surgery	102
Scissors, micro	110-116	TOENNIS-ADSON, scissors for vascular and neuro surgery	102
Scissors, micro adventitia	111,113	TOENNIS-ADSON-DELICATE, scissors tungsten carbide TUC	127
Scissors, micro dissection	111,113	TOHOKU-JAPAN, towel forceps	67
Scissors, micro nerve	113	TÖNNIS, vascular spatulas	251
Scissors, super-cut SC	91	Tonsil hemostatic forceps	55
SELLORS, rib contractors	254	Tourniquets	299
SELLORS-CRAFOORD, auricle forceps	57	Towel clamps	66,67
SEMB, bone cutting forceps	232	Trocar sleeves and trocars	321-325
SEMB, bone rongeurs	225	TROUTMAN, micro needle holders with pen-type handle	157
SEMB, bronchus clamps	297	TROUTMAN-BARRAQUER, m. needle holders with pen-type handle	156
SEMB, costal periosteotomes	236	TUBBS, dilators	299
SEMKEN, dissecting forceps tungsten TUC	85	Tubing clamps	68
SEMKEN, dressing and tissue forceps	77,78	TÜBINGEN MODELL, retractors	184
SENN-GREEN, delicate retractors	173	TUDOR-EDWARDS, bone cutting forceps	231
SENNING (SWEDISH PATTERN), needle holders tungsten TUC	142	TUFFIER, artery forceps	42
SENN-MILLER, delicate retractors	176	TUFFIER, retractors	185
SENN-MILLER-BABY, delicate retractors	176	TUFFIER, rib spreaders	240
Setting forceps	41	Tungsten Carbide Tips with pyramidal profile	136,137
SIMON, retractors	184	U	
SMITH-PETERSON, bone rongeurs	228	UCKERMANN, cotton applicators	203
SMITH-POTTS, dissecting forceps tungsten TUC	85	ULRICH, polypus forceps	165
SMITH-POTTS, dressing and tissue forceps	81	UNIVERSAL, scissors tungsten carbide TUC	128
SMITH-POTTS, micro needle holders tungsten TUC	153	V	
SMITH-POTTS, scissors for vascular surgery	99,101	Varicose vein probe set	203
SMITH-POTTS, scissors tungsten carbide TUC	123	Vascular dilators	204,205
SNITMAN, self-retaining retractors	194	Vascular, strippers	206
Spatulas	251	Vena-cava forceps	298
SPENCER-WELLS, artery forceps	44	VERNET-GIL, delicate retractors	175
Spinal retractors	176	Vessel instruments and probes	199-209
Sponge Forceps	163-169	VOLKMANN, retractors	177,178
STACKE, probes	201	W	
STANDARD, dressing forceps	75	WALTON, fine scissors	106
STANDARD, scissors tungsten TUC	118,119	WALTON-LISTON, bone cutting forceps	230
STANDARD, tissue forceps	75	WALTON-YANKAUER, suction tubes	213
STERNUM, wire twisting forceps tungsten TUC	151	WANGENSTEEN, dissecting forceps tungsten TUC	87
STEVENS, scissors tungsten carbide TUC	127	WANGENSTEEN, needle holders tungsten TUC	145
STEVENS, tenotomy scissors	109	WEBER, atrauma forceps	277
STILLE, bone rongeurs	225	WEBSTER, needle holders tungsten TUC	143
STILLE-LISTON, bone cutting forceps	231	WEITLANER, selfretaining retractors	195
STILLE-LUER, bone rongeurs	226	WEITLANER-BABY, selfretaining retractors	195
STILLE-RUSKIN, bone rongeurs	225	WELLS-SPENCER, artery forceps	44
STRATTE, needle holders tungsten TUC	145	WERTHEIM, needle holders tungsten TUC	146
Strippers, vascular	206	WIKSTROEM, dissecting and ligature forceps	65
STRULLY, scissors for vascular and neuro surgery	101	Wire forceps	222,223
SUBRAMANIAN, atrauma forceps	296	Wire twisting forceps with tungsten carbide inserts TUC	151
SUBRAMANIAN-MINIATURE, atrauma forceps	296	Y	
Suction and irrigation tubes, endoscopy	318,319	YANKAUER, suction tubes	213
Suction tubes and cannulae	211-216	YANKAUER-WALTON, suction tubes	213
SULLIVAN (BROPHY), fine scissors	105	Z	
Super Cut Scissors	91	ZAUFAL-JANSEN, bone rongeurs	224
Super Cut Scissors with tungsten carbide inserts TUC	117	ZENKER, dissecting and ligature forceps	60
Suture	135-161	ZENKER, retractors	190
Suture tying forceps with platform	82,83	ZWEIFEL, needle holders tungsten TUC	150
T			
TAYLOR, dressing and tissue forceps	78,79		
TAYLOR, spinal retractors	176		
TAYLOR-CUSHING, dissecting forceps tungsten TUC	86		
TAYLOR-SCHMIEDEN, scissors for vascular and neuro surgery	102		
Telescopes	304,305		
TERRIER, artery forceps	44		
Thoracoscopy	301-343		

Indice alfabética

	Página		Página
A			
Accesorios para power drills	220	BERNHARD, pinzas para compresas	66
Accu power drill	219	BETHUNE, costotomos	237
Acumulador / cargador para power drills	221	BEYER, pinzas-gubias	224
Adaptadores	333	BIEMER, clips vasculares	258
ADSON, pinzas	76,77	BIEMER, ganchos	253
ADSON, pinzas de disección tungsteno TUC	86	BILLROTH, separadores	178
ADSON, pinzas hemostáticas	53	BIRKETT, pinzas para preparaciones y ligaduras	65
ADSON, separadores autoestaticos	196,197	Bisturios	129-134
ADSON, tubos de aspiración	216	Bocas de carburo de tungsteno, perfil de estructura piramidal	136,137
ADSON-ANDERSON, separadores autoestaticos	196	BONNEY, pinzas de disección tungsteno TUC	87
ADSON-BABY, pinzas hemostáticas	53	BOYNTON, porta-agujas tungsteno TUC	149
ADSON-BABY, separadores autoestaticos	198	BOZEMANN, porta-agujas tungsteno TUC	145
ADSON-BROWN, pinzas de disección con dientes	77	BRIDGE, pinzas para preparaciones y ligaduras	62
ADSON-MICRO, pinzas de disección	76	BRODIE, sondas	202
ADSON-MICRO, pinzas de disección con dientes	76	BROM, ganchos	252
ADSON-TOENNIS, tijeras para cirugía vasculares	102	BROPHY (SULLIVAN), tijeras finas	105
ADSON-TOENNIS-DELICATE, tijeras tungsteno TUC	127	BROPHY, pinzas de disección	81
Adventitia, micro-tijeras	111,113	BROPHY, pinzas de disección con dientes	81
AF-accesorios	326-331	BROWN-ADSON, pinzas de disección con dientes	77
Air power drill	219	BRUNNER, costotomos	238
ALEXANDER, periostótomos para costillas	235	BURFORD, separadores costales	250
ALLIS, pinzas para coger tejidos	38	BYRD, tubos de aspiración	214
ALLIS-ADAIR, pinzas para coger tejidos	38	C	
ALLIS-BABY, pinzas para coger tejidos	38	Cables de conexión	326
ALLISON, espátulas pulmonares	255	Cables fibra óptica	332
ALM, separadores autoestaticos	194	CAIRNS, pinzas hemostáticas	50
ANDERSON-ADSON, separadores autoestaticos	196	Cámaras	339-341
ANDREWS-PYNCHON, tubos de aspiración	213	Camisa para trocares y trocares	321-325
ANKENEY, separadores costales	242,243	Cánulas de aspiración endoscopia	318,319
Aproximadores para costillas	254	Canulas y tubos de aspiración	211-216
ARRUGA, porta-agujas tungsteno TUC	149	Cardiovascular	233-299
Atrauma clamps bulldog	260-263	CARMALT-ROCHESTER, pinzas hemostáticas	55
AUSTIN, pinzas de ligadura	82	CARREL, pinzas hemostáticas	44
B			
BABCOCK, pinzas para coger intestinos	39	CARROLL, porta-agujas tungsteno TUC	142
BABY-ADSON, pinzas hemostáticas	53	CARTILAGE-MARTIN, tijeras	104
BABY-ADSON, separadores autoestaticos	198	CASTANEDA, pinzas atrauma	294
BABY-CRILE-WOOD, porta-agujas tungsteno TUC	144	CASTANEDA, separadores costales	249
BABY-MIXTER, pinzas para preparaciones y ligaduras	61	CASTROVIEJO, micro-porta-agujas	160
BABY-OVERHOLT, pinzas para preparaciones y ligaduras	51	CASTROVIEJO, micro-porta-agujas tungsteno TUC	152,153
BABY-POOLE, tubos de aspiración	214	CHAPUT, pinzas hemostáticas	42
BABY-SATINSKY, clamps vena cava	298	CHURCH, tijeras para cirugía vasculares	103
BABY-SENN-MILLER, separadores finas	176	Cizallas para huesos	237,238
BABY-WEITLANER, separadores autoestaticos	195	Clamps bulldog	40,41
BACKHAUS, pinzas de campo	67	Clamps vena cava	298
BACKHAUS, pinzas para compresas	67	CLASSON, tijeras para cirugía vasculares	103
BADGLEY, separadores costales	240	CLEVELAND, pinzas cortantes para huesos	230
BAILEY, aproximadores para costillas	254	CLEVELAND-GARDNER, pinzas cortantes p.huesos	229
BAILEY-BABY, aproximadores para costillas	254	Clips	257-259
BAILEY-GIBBON, aproximadores para costillas	254	COLLER, pinzas hemostáticas	47
BAINBRIDGE, pinzas atrauma	268	COLLIN, mangos de bisturios	132
BAINBRIDGE, pinzas hemostáticas	55	CONE, separadores autoestaticos	198
BALL & SOCKET, pinzas de campo	67	CONVERSE, porta-agujas tungsteno TUC	143
BALL & SOCKET, pinzas para compresas	67	COOLEY, dilatadores	299
BALLENGER-FOERSTER, pinzas para esponjas	168	COOLEY, dilatadores vasculares	204
BARRAQUER, micro-porta-agujas con mango redondo	156	COOLEY, pinzas atrauma	285-288,291
BARRAQUER-TROUTMAN, micro-porta-agujas con mango redondo	156	COOLEY, separadores aurícula	256
BECK, pinzas atrauma	283,289	COOLEY, separadores costales	249
BECK-LUETHY, porta-agujas tungsteno TUC	150	COOLEY, tubos de aspiración	215
BENGOLEA, pinzas hemostáticas	56	COOLEY-DERRA, pinzas atrauma	289
BERNHARD, pinzas de campo	66	COOLEY-STRUCK, separadores aurícula	256
		CORWIN, pinzas para torcer hilos tungsteno TUC	151
		CORYLLOS, costotomos	237
		CORYLLOS, separadores	192

	Página		Página
Costotomos	237,238	easyClean	306-309
COTTLE KAZANJIAN, pinzas cortantes para huesos	229	ECHLIN, pinzas-gubias	227
COUPLAND, tubos de aspiración	214	EISELSBERG-MATHIEU, porta-agujas tungsteno TUC	150
CRAFOORD, pinzas-clamps bronquias	58	Electrodos	327,328
CRAFOORD, tijeras	104	Electrodos con tubo de succión	314-317,320
CRAFOORD-SELLORS, pinzas para aurícula	57	Electrodos/Succión/Irrigación/Agujas/Trócares	314-325
CRILE, ganchos	252	ENGL. MODELL, pinzas de campo	66
CRILE, pinzas hemostáticas	47	ENGL. MODELL, pinzas para compresas	66
CRILE-RANKIN, pinzas hemostáticas	47	Espátulas	251
CRILE-WOOD, porta-agujas tungsteno TUC	144	Espátulas pulmonares	255
CRILE-WOOD-BABY, porta-agujas tungsteno TUC	144	EUFRATE PASQUE, porta-agujas tungsteno TUC	141
CUSHING, ganchos	172,174,252	EWALD, pinzas de disección	77
CUSHING, pinzas de disección	80	EWALD, pinzas de disección con dientes	77
CUSHING, pinzas de disección con dientes	80		
CUSHING, pinzas de disección tungsteno TUC	86	F	
CUSHING, separadores espinales	176		
CUSHING-TAYLOR, pinzas de disección tungsteno TUC	86	FARRELL, porta-algodones	202
		FAVALORO, tijeras para cirugía vasculares	101
D		FEIN, porta-algodones	203
		FERGUSON, tubos de aspiración	216
DALE, pinzas atrauma	282	FINOCCHIETTO, porta-agujas tungsteno TUC	145
DANDY, pinzas hemostáticas para pericráneo	54	FINOCCHIETTO, separadores costales	241,248
DANDY, tijeras para cirugía vasculares	101	FINOCCHIETTO, tijeras	104
DARDIK, pinzas atrauma	290	FINOCCHIETTO-BABY, separadores costales	241
DAVIDSON, separadores	193	FINSEN, separadores autoestaticos	194
DAVIS, espátulas vasculares	251	FISCH, ganchos	253
DAVIS-RAGNELL, separadores finas	176	FOERSTER-BALLENGER, pinzas para esponjas	168
DE BAKEY, atrauma clamps bulldog	260	FOX-GOLDMAN, tijeras tungsteno TUC	127
DE BAKEY, dilatadores vasculares	205	FRANKENFELDT, pinzas para coger	207
DE BAKEY, pinzas atrauma	84	FRAZIER, tubos de aspiración	216
DE BAKEY, pinzas atrauma	267,269-273,275,279,284,295	FRENCH-EYE/RYDER, porta-agujas tungsteno TUC	141
DE BAKEY, pinzas de disección tungsteno TUC	87	FRYKHOLM, pinzas-gubias	227
DE BAKEY, porta-agujas tungsteno TUC	140	Fuentes de luz fría	332-338
DE BAKEY, separadores costales	245,246	FULTON, tijeras para cirugía vasculares	103
DE BAKEY, tijeras para cirugía vasculares	99,102		
DE BAKEY, tijeras tungsteno TUC	123	G	
DE BAKEY, tubos de aspiración	213		
DE BAKEY-BAHNSON, pinzas atrauma	275	Ganchos	172-175,252,253
DE BAKEY-CAROTIS, atrauma clamps bulldog	262	GARRETT, dilatadores vasculares	204
DE BAKEY-HESS, clips vasculares	259	GEISSENDOERFER-OVERHOLT, pinzas para preparaciones y ligaduras	51
DE BAKEY-MOSQUITO, pinzas atrauma	264	GEMINI, pinzas para preparaciones y ligaduras	63
DE BAKEY-PEAN, pinzas atrauma	265	GERALD, pinzas de disección	80
DE BAKEY-RANKIN, pinzas atrauma	264	GERALD, pinzas de disección con dientes	80
DE BAKEY-SATINSKY, atrauma clamps bulldog	262	GIERTZ-STILLE, costotomos	238
DE MARTEL-POTTS, tijeras para cirugía vasculares	102	GILLIES, ganchos	253
DEAVER, separadores	187-189	GILLIES, pinzas de disección tungsteno TUC	85
DERF, porta-agujas tungsteno TUC	143	GILLIES, porta-agujas tungsteno TUC	146
DERRA, pinzas atrauma	282	GIL-VERNET, ganchos	175
DESMARRES, ganchos	174	GLOVER, atrauma clamps bulldog	261
Desobliteradores de vasos	206	GLOVER, pinzas atrauma	283
DIEFFENBACH, clamps bulldog	41	GLUCK, costotomos	237
DIETHRICH, micro-porta-agujas tungsteno TUC	153	GOLDMAN-FOX, tijeras tungsteno TUC	127
DIETHRICH-HEGEMANN, tijeras para cirugía vasculares	100	GORNEY, pinzas para preparaciones	97
DIETRICH, pinzas atrauma	281	GREEN-SENN, ganchos	173
Dilatadores	299	GREGORY, pinzas atrauma	281
Dilatadores vasculares	204,205	GREGORY-SOFT, atrauma clamps bulldog	263
Dissection, micro-tijeras	111,113	GROSS-MAIER, pinzas para pólipos	166,167
DIXON-LOVELACE, pinzas hemostáticas	54		
DOYEN, periostótomos para costillas	235	H	
DOYEN, pinzas de campo	66		
DOYEN, pinzas para compresas	66	HAIGHT, separadores costales	239
DOYEN, separadores	185	HALSEY, porta-agujas tungsteno TUC	143
DOYEN, sondas	201	HALSTED, pinzas hemostáticas	46
DUNHILL, pinzas hemostáticas	50	HALSTED-MOSQUITO, pinzas hemostáticas	45
DUVAL, pinzas para coger intestinos	39	HARKEN, clamps vena cava	298
		HARKEN, pinzas atrauma	276
E		HARRINGTON, separadores	185
		HARTMANN, pinzas hemostáticas	44
		HEGAR, dilatadores	208,209

	Página		Página
HEGAR-OLSEN, porta-agujas tungsteno TUC	146	LANGENBECK-KOCHER, separadores	181
HEGEMANN-DIETHRICH, tijeras para cirugía vasculares	100	LANGENBECK-MINI, ganchos	173
HEISS, pinzas hemostáticas	58	LANGENBECK-RYDER, porta-agujas tungsteno TUC	150
HERTZLER, separadores costales	240	LAWRENCE, pinzas para preparaciones y ligaduras	62
Hojas de bisturíes	133,134	LEBSCHKE, costotomos	238
HOPKINS-JOHNS, clamps bulldog	41	LEES, pinzas atrauma	278
HOPKINS-JOHNS, pinzas para poner	41	LEKSELL-STILLE, pinzas-gubias	226
HOPKINS-JOHNS, pinzas para preparaciones y ligaduras	60	LELAND-JONES, pinzas atrauma	268
HORNE-JOBSON, porta-algodones	203	LERICHE, pinzas hemostáticas	46
HÖSEL, porta-agujas tungsteno TUC	149	LEXER, tijeras para preparaciones	97
HOSPITAL-PROVIDENCE, pinzas hemostáticas	46	LEXER, tijeras tungsteno TUC	124
I		LICHTENBERG, porta-agujas tungsteno TUC	149
I.M.A. MAMMARIA, separadores costales	239	LINCOLN, tijeras para cirugía vasculares	103
Instrumental vascular y sondas	199-209	LISTER, tijeras tungsteno TUC	128
Instrumentos para huesos	217-232	LISTON, pinzas cortantes para huesos	229,232
Instrumentos para Laparoscopia / Tórax	306-313	LISTON-KEY, pinzas cortantes para huesos	231
ISRAEL, separadores	179	LITTAUER-LISTON, pinzas cortantes para huesos	229
J		LITTLER, tijeras finas	105
JACOBSON, micro-porta-agujas	160	LOCKHART-MUMMERY, sondas	202
JACOBSON, micro-porta-agujas tungsteno TUC	152	LORNA, pinzas de campo	67
JACOBSON, porta-agujas tungsteno TUC	142	LORNA, pinzas para compresas	67
JANSEN, separadores autoestáticos	194	LOTH-KLINKENBERGH, tijeras para cirugía vasculares	103
JAVID, pinzas atrauma	285	LOVELACE, pinzas clamps para pulmon	297
JEWELER, pinzas de disección tungsteno TUC	85	LOVELACE-DIXON, pinzas hemostáticas	54
JOBSON-HORNE, porta-algodones	203	LUETHY-BECK, porta-agujas tungsteno TUC	150
JOHNS-HOPKINS, clamps bulldog	41	M	
JOHNS-HOPKINS, pinzas para poner	41	MAIER-GROSS, pinzas para pólipos	166,167
JOHNS-HOPKINS, pinzas para preparaciones y ligaduras	60	Mangos de bisturíes	131-133
JONES, pinzas de campo	66	MARKWALDER, pinzas cortantes para huesos	229
JONES, pinzas para compresas	66	MARQUARDT, pinzas-gubias	224
JOSEPH, tijeras para preparaciones	98	MARTIN, separadores	184
K		MARTIN-CARTILAGE, tijeras	104
KADER, separadores	191	MASSON, porta-agujas tungsteno TUC	145
KALT, micro-porta-agujas tungsteno TUC	153	MATHIEU, porta-agujas tungsteno TUC	147
KANTROWITZ, pinzas para preparaciones y ligaduras	63	MATHIEU-DELICATE, porta-agujas tungsteno TUC	147
KAYE, tijeras para Face-lift TUC	127	MATHIEU-EISELSBERG, porta-agujas tungsteno TUC	150
KELLY, pinzas hemostáticas	47	MATHIEU-RYDER VASCULAR, porta-agujas tungsteno TUC	148
KELLY, separadores	186	MATHIEU-RYDER, porta-agujas tungsteno TUC	148
KELLY-RANKIN, pinzas hemostáticas	47	MATSON, periostótomos para costillas	235
KILNER (RAGNELL), tijeras para preparaciones	98	MAYFIELD, pinzas-gubias	224
KILNER, ganchos	253	MAYO, tijeras tungsteno TUC	119
KILNER, porta-agujas tungsteno TUC	143	MAYO-HEGAR, porta-agujas tungsteno TUC	140
KLINIKUM BERLIN, pinzas para tubos	68	MAYO-HEGAR-DELICATE, porta-agujas tungsteno TUC	140
KLINKENBERGH-LOTH, tijeras para cirugía vasculares	103	MC INDOE, pinzas cortantes para huesos	230
KOCHER, separadores	177,182	MC INDOE, pinzas de disección	77
KOCHER-DELICATE, pinzas hemostáticas	50	MC INDOE, tijeras	104
KOCHER-LANGENBECK, separadores	181	MEEKER, pinzas para preparaciones y ligaduras	53
KOCHER-OCHSNER, pinzas hemostáticas	49	MEHDORN, clips vasculares	258
KOERTE, separadores	178,189	METZENBAUM, porta-agujas tungsteno TUC	147
KRAYENBÜHL, ganchos	252	METZENBAUM, tijeras tungsteno TUC	121,122
KROENLEIN, pinzas hemostáticas	43	METZENBAUM-DELICATE, tijeras para preparaciones	96
L		METZENBAUM-DELICATE, tijeras tungsteno TUC	124-126
LAMBERT-KAY, pinzas atrauma	275	METZENBAUM-NELSON, tijeras para preparaciones	95
LAMBOTTE, periostótomos para costillas	236	MEYERDING, ganchos	173
LANDOLT, tijeras finas	106	Micro tijeras	110-116
LANE, pinzas de campo	66	Micro, tijeras Adventitia	111,113
LANE, pinzas de disección	79	Micro, tijeras Dissection	111,113
LANE, pinzas para compresas	66	Micro, tijeras Nerve	113
LANGENBECK, porta-agujas tungsteno TUC	150	MICRO-ADSON, pinzas de disección	76
LANGENBECK, separadores	180	MICRO-ADSON, pinzas de disección con dientes	76
LANGENBECK-DELICATE, porta-agujas tungsteno TUC	150	MICRO-MOSQUITO, pinzas hemostáticas	45
		Micro-pinzas	82,83
		Micro-porta-agujas	160,161
		Micro-porta-agujas con bocas de carburo de tungsteno	152,153
		Micro-porta-agujas con mango redondo	156-159
		MICRO-RYDER, porta-agujas tungsteno TUC	141
		MICROVASCULAR, porta-agujas TUC	141

	Página		Página
MIKULICZ, separadores	186	Pinzas para aurícula	57
MILLER-SENN, separadores finas	176	Pinzas para coger intestinos	39
MILLS, tijeras para cirugía vasculares	102	Pinzas para coger tejidos	38
MINI, hojas de bisturíes	133	Pinzas para compresas	66,67
MINI, mangos de bisturíes	133	Pinzas para hilos	222,223
MINI-LANGENBECK, ganchos	173	Pinzas para la Bi-Coagulación	331
MIXTER, pinzas para preparaciones y ligaduras	61,62	Pinzas para polipos	163-169
MIXTER-BABY, pinzas para preparaciones y ligaduras	61	Pinzas para poner	41
MIXTER-O'SHAUGNESSY, pinzas para preparaciones y ligaduras	61	Pinzas para preparaciones y ligaduras	51-53,57,59-65
MIXTER-OVERHOLT, pinzas para preparaciones y ligaduras	57	Pinzas para torcer hilos tungsteno TUC	151
MOD. BONN, tijeras finas	106	Pinzas para tubos	68
MODELL TUBINGEN, separadores	184	Pinzas, micro	82,83
MOLDESTADT, ganchos	172	Pinzas-clamps bronquiales	297
MORRIS, separadores	183	Pinzas-clamps bronquiales	58
MORRIS-DE BAKEY, pinzas atrauma	280	Pinzas-clamps para pulmón	297
MORSE FAVALORO, separadores costales	247	Pinzas-gubias	224-228
MOSQUITO-HALSTED, pinzas hemostáticas	45	PLESTER, tubos de aspiración	216
MOSQUITO-MICRO, pinzas hemostáticas	45	POOLE, tubos de aspiración	214
MÜLLER, clips vasculares	259	POOLE-BABY, tubos de aspiración	214
MUMMERY-LOCKHART, sondas	202	Porta-agujas con bocas de carburo de tungsteno	140-155
MYRTLE LEAF, sondas	201	Porta-algodones	202,203
		POTTS, pinzas atrauma	266
N		POTTS-DE MARTEL, tijeras para cirugía vasculares	102
NABATOFF, sondas para várices	203	POTTS-SMITH, micro-porta-agujas tungsteno TUC	153
NEIVERT, porta-agujas tungsteno TUC	143	POTTS-SMITH, pinzas de disección	81
NELATON, sondas	201	POTTS-SMITH, pinzas de disección con dientes	81
NELSON-METZENBAUM, tijeras para preparaciones	95	POTTS-SMITH, pinzas de disección tungsteno TUC	85
Nerve, micro tijeras	113	POTTS-SMITH, tijeras	104
NEW ORLEANS, porta-agujas tungsteno TUC	142	POTTS-SMITH, tijeras para cirugía vasculares	99,101
nopa DIAMOND, porta agujas	154,155	POTTS-SMITH, tijeras tungsteno TUC	123
		PRATT, sondas	202
O		PRESBYTERIAN, pinzas para tubos	68
O'BRIEN, tijeras finas	106	PRICE-THOMAS, pinzas clamps bronquiales	297
OCHSNER, pinzas atrauma	281	PROVIDENCE-HOSPITAL, pinzas hemostáticas	46
OCHSNER-KOCHER, pinzas hemostáticas	49	PYNCHON-ANDREWS, tubos de aspiración	213
OEHLER, pinzas de disección tungsteno TUC	85		
OLLIER, separadores	179	R	
OLSEN-HEGAR, porta-agujas tungsteno TUC	146	RAGNELL (KILNER), tijeras para preparaciones	98
Ópticas	304,305	RAGNELL-DAVIS, separadores finas	176
O'SHAUGNESSY-MIXTER, pinzas para preparaciones y ligaduras	61	RAMPLEY, pinzas para esponjas	169
OVERHOLT, pinzas para preparaciones y ligaduras	52	RANKIN-CRILE, pinzas hemostáticas	47
OVERHOLT-BABY, pinzas para preparaciones y ligaduras	51	RANKIN-KELLY, pinzas hemostáticas	47
OVERHOLT-GEISSENDOERFER, pinzas para preparaciones y ligaduras	51	REILL, micro-porta-agujas con mango redondo	157
OVERHOLT-MIXTER, pinzas para preparaciones y ligaduras	57	REYNOLDS, tijeras para preparaciones	98
		ROBERTS, pinzas hemostáticas	58
P		ROCHESTER-CARMALT, pinzas hemostáticas	55
PEAN, pinzas hemostáticas	43	ROCHESTER-PEAN, pinzas hemostáticas	48
PEAN-DELICATE, pinzas hemostáticas	50	ROEDER, pinzas de campo	67
PEAN-ROCHESTER, pinzas hemostáticas	48	ROEDER, pinzas para compresas	67
PEERS, pinzas de campo	67	ROETTGEN-RUSKIN, pinzas-gubias	226
PEERS, pinzas para compresas	67	RUMEL, pinzas para preparaciones y ligaduras	59
PENFIELD, espátulas	251	RUMEL-BELMONT, torniquetes	299
Periostótomos para costillas	235,236	RUSKIN, pinzas-gubias	224,228
Pinzas	71-87	RUSKIN-LISTON, pinzas cortantes para huesos	230
Pinzas atrauma	84	RYDER/FRENCH-EYE, porta-agujas tungsteno TUC	141
Pinzas atrauma	264-296	RYDER-LANGENBECK, porta-agujas tungsteno TUC	150
Pinzas cortantes para huesos	229-232	RYDER-MATHIEU VASCULAR, porta-agujas tungsteno TUC	148
Pinzas de aprehensión endoscopia	307-312	RYDER-MATHIEU, porta-agujas tungsteno TUC	148
Pinzas de campo	66,67	RYDER-MICRO, porta-agujas tungsteno TUC	141
Pinzas de disección con bocas de carburo de tungsteno	85-87	S	
Pinzas de ligadura con plataforma	82,83	SANTULLI, atrauma clamps bulldog	260
Pinzas hemostáticas	35-68	SANVENERO, tijeras para preparaciones	98
Pinzas hemostáticas delgadas	50	SAROT, pinzas-clamps bronquiales	58
Pinzas hemostáticas finas	45	SAROT, porta-agujas tungsteno TUC	145
Pinzas hemostáticas para amígdalas	55	SATINSKY, clamps vena cava	298
Pinzas monopolares	329	SATINSKY, pinzas atrauma	272,274

	Página		Página
SATINSKY, tijeras para cirugía vasculares	103	Tijeras con fillos de carburo de tungsteno	118-128
SAUERBRUCH, costotomos	237	Tijeras coronarias	101
SAUERBRUCH, pinzas-gubias	227	Tijeras finas	105-109
SAUERBRUCH, separadores	182,192	Tijeras micro	110-116
SAWTELL-SCHNIDT, pinzas hemostáticas para amígdalas	55	Tijeras para cartilago	104
SCHAEDEL, pinzas de campo	66	Tijeras para cirugía vasculares	99-103
SCHAEDEL, pinzas para compresas	66	Tijeras para disección	104
SCHMID, espátulas vasculares	251	Tijeras para enterotomos	104
SCHMIEDEN-TAYLOR, tijeras para cirugía vasculares	102	Tijeras para Face-lift TUC	127
SCHNIDT-SAWTELL, pinzas hemostáticas para amígdalas	55	Tijeras para iridectomía	107
SELLORS, aproximadores para costillas	254	Tijeras para lobectomía	104
SELLORS-CRAFOORD, pinzas para aurícula	57	Tijeras para nervios	97
SEMB, periostótomos para costillas	236	Tijeras para preparaciones	95-98
SEMB, pinzas clamps bronquiales	297	Tijeras Super-Cut SC	91
SEMB, pinzas cortantes para huesos	232	tini instruments (titan-nitride surface coating)	69,70
SEMB, pinzas-gubias	225	titan instruments	37,73,93,116,139
SEMKEN, pinzas de disección	77,78	TOENNIS, pinzas para preparaciones y ligaduras	64
SEMKEN, pinzas de disección con dientes	77,78	TOENNIS, porta-agujas tungsteno TUC	149
SEMKEN, pinzas de disección tungsteno TUC	85	TOENNIS, tijeras para cirugía vasculares	102
SENN-GREEN, ganchos	173	TOENNIS-ADSON, tijeras para cirugía vasculares	102
SENNING (SWEDISH PATTERN), porta-agujas tungsteno TUC	142	TOENNIS-ADSON-DELICATE, tijeras tungsteno TUC	127
SENN-MILLER, separadores finas	176	TOHOKU-JAPAN, pinzas de campo	67
SENN-MILLER-BABY, separadores finas	176	TOHOKU-JAPAN, pinzas para compresas	67
Separadores aurícula	256	TÖNNIS, espátulas vasculares	251
Separadores	171-198	Toracoscopia	301-343
Separadores costales	239-250	Torniquetes	299
Separadores endoscopia	313	TROUTMAN, micro-porta-agujas con mango redondo	157
Separadores espinales	176	TROUTMAN-BARRAQUER, micro-porta-agujas con mango redondo	156
Separadores finas	176	TUBBS, dilatadores	299
SIMON, separadores	184	TÜBINGER MODELL, separadores	184
Sistema de brazo articulado con fijación central	342,343	Tubos de aspiración y canulas	211-216
SMITH-PETERSON, pinzas-gubias	228	TUDOR-EDWARDS, pinzas cortantes para huesos	231
SMITH-POTTS, micro-porta-agujas tungsteno TUC	153	TUFFIER, pinzas hemostáticas	42
SMITH-POTTS, pinzas de disección tungsteno TUC	85	TUFFIER, separadores	185
SMITH-POTTS, tijeras para cirugía vasculares	99,101	TUFFIER, separadores costales	240
SNITMAN, separadores autoestáticos	194		
Sondas	201,202	U	
Sondas para várices	203	UCKERMANN, porta-algodones	203
Sondas y instrumental vascular	199-209	ULRICH, pinzas para pólipos	165
SPENCER-WELLS, pinzas hemostáticas	44	UNIVERSAL, tijeras tungsteno TUC	128
STACKE, sondas	201		
STANDARD, pinzas de disección	75	V	
STANDARD, pinzas de disección con dientes	75	VERNET-GIL, ganchos	175
STANDARD, tijeras tungsteno TUC	118,119	VOLKMANN, separadores	177,178
STERNUM, pinzas para torcer hilos tungsteno TUC	151		
STEVENS, tijeras para tenotomía	109	W	
STEVENS, tijeras tungsteno TUC	127	WALTON, tijeras finas	106
STILLE, pinzas-gubias	225	WALTON-LISTON, pinzas cortantes para huesos	230
STILLE-LISTON, pinzas cortantes para huesos	231	WALTON-YANKAUER, tubos de aspiración	213
STILLE-LUER, pinzas-gubias	226	WANGENSTEEN, pinzas de disección tungsteno TUC	87
STILLE-RUSKIN, pinzas-gubias	225	WANGENSTEEN, porta-agujas tungsteno TUC	145
STRATTE, porta-agujas tungsteno TUC	145	WEBER, pinzas atrauma	277
STRULLY, tijeras para cirugía vasculares	101	WEBSTER, porta-agujas tungsteno TUC	143
SUBRAMANIAN, pinzas atrauma	296	WEITLANER, separadores autoestáticos	195
SUBRAMANIAN-MINIATURE, pinzas atrauma	296	WEITLANER-BABY, separadores autoestáticos	195
SULLIVAN (BROPHY), tijeras finas	105	WELLS-SPENCER, pinzas hemostáticas	44
Super Cut Tijeras SC	91	WERTHEIM, porta-agujas tungsteno TUC	146
Super Cut tijeras SC con fillos de carburo de tungsteno TUC	117	WIKSTROEM, pinzas para preparaciones y ligaduras	65
Sutura	135-161		
T		Y	
TAYLOR, pinzas de disección	78,79	YANKAUER, tubos de aspiración	213
TAYLOR, pinzas de disección con dientes	78,79	YANKAUER-WALTON, tubos de aspiración	213
TAYLOR, separadores espinales	176		
TAYLOR-CUSHING, pinzas de disección tungsteno TUC	86		
TAYLOR-SCHMIEDEN, tijeras para cirugía vasculares	102		
TERRIER, pinzas hemostáticas	44		
Tijeras	89-128		

Z

ZAUFAL-JANSEN, pinzas-gubias	224
ZENKER, pinzas para preparaciones y ligaduras	60
ZENKER, separadores	190
ZWEIFEL, porta-agujas tungsteno TUC	150

Index

	Page		Page
A			
Accessoires pour power drills	220	BONNEY, pinces à dissection tungstène TUC	87
Accu power drill	219	BOYNTON, porte-aiguilles tungstène TUC	149
Accumulateur / chargeur d'accus	221	BOZEMANN, porte-aiguilles tungstène TUC	145
Adaptateur	333	BRIDGE, pinces à dissection et à ligatures	62
ADSON, canules d'aspiration	216	BRODIE, sondes	202
ADSON, écarteurs autostatiques	196,197	BROM, crochets très fins	252
ADSON, pinces	76,77	BROPHY (SULLIVAN), ciseaux fins	105
ADSON, pinces à dissection et à ligatures	53	BROPHY, pinces à dissection et à griffes	81
ADSON, pinces à dissection tungstène TUC	86	BROWN-ADSON, pinces à griffes	77
ADSON-ANDERSON, écarteurs autostatiques	196	BRUNNER, costotomes	238
ADSON-BABY, écarteurs autostatiques	198	Bulldog clamps	40,41
ADSON-BABY, pinces à dissection et à ligatures	53	BURFORD, écarteurs des côtes	250
ADSON-BROWN, pinces à griffes	77	BYRD, canules d'aspiration	214
ADSON-MICRO, pinces à dissection et à griffes	76	C	
ADSON-TOENNIS, ciseaux vasculaires	102	Câbles de raccordement	326
ADSON-TOENNIS-DELICATE, ciseaux tungstène TUC	127	Câbles fibre optique	332
Adventitia, micro-ciseaux	111,113	CAIRNS, pinces hémostatiques	50
Air power drill	219	Caméras	339-341
ALEXANDER, rugines raspatoires	235	Canules d'aspiration endoscopie	318,319
ALLIS, pinces pour saisir le tissu	38	Canules et tubes d'aspiration	211-216
ALLIS-ADAIR, pinces pour saisir le tissu	38	Cardiovasculaire	233-299
ALLIS-BABY, pinces pour saisir le tissu	38	CARMALT-ROCHESTER, pinces hémostatiques	55
ALLISON, spatules pulmonaires	255	CARREL, pinces hémostatiques	44
ALM, écarteurs autostatiques	194	CARROLL, porte-aiguilles tungstène TUC	142
ANDERSON-ADSON, écarteurs autostatiques	196	CARTILAGE-MARTIN, ciseaux	104
ANDREWS-PYNCHON, canules d'aspiration	213	CASTANEDA, écarteurs des côtes	249
ANKENEY, écarteurs des côtes	242,243	CASTANEDA, pinces atraumatiques	294
ARRUGA, porte-aiguilles tungstène TUC	149	CASTROVIEJO, micro-porte-aiguilles	160
AUSTIN, pinces à ligatures avec plate-forme	82	CASTROVIEJO, micro-porte-aiguilles tungstène TUC	152,153
B			
BABCOCK, pinces pour saisir l'intestin	39	CHAPUT, pinces hémostatiques	42
BABY-ADSON, pinces à dissection	53	CHURCH, ciseaux vasculaires	103
BABY-CRILE-WOOD, porte-aiguilles tungstène TUC	144	Cisailles pour os	237,238
BABY-MIXTER, pinces à dissection et à ligatures	61	Ciseaux	89-128
BABY-OVERHOLT, pinces à dissection et à ligatures	51	Ciseaux à dissection	95-98
BABY-POOLE, canules d'aspiration	214	Ciseaux à épisiotomie	104
BABY-SATINSKY, pinces vena cava	298	Ciseaux à iridectomie	107
BABY-SENN-MILLER, écarteurs fins	176	Ciseaux à lobectomie	104
BABY-WEITLANER, écarteurs autostatiques	195	Ciseaux à préparation	104
BACKHAUS, pinces à champs	67	Ciseaux avec plaquettes en carbure de tungstène	118-128
BADGLEY, écarteurs des côtes	240	Ciseaux coronaires	101
BAILEY, rapprocheurs des côtes	254	Ciseaux fins	105-109
BAILEY-BABY, rapprocheurs des côtes	254	Ciseaux pour chirurgie vasculaire	99-103
BAILEY-GIBBON, rapprocheurs des côtes	254	Ciseaux pour Face-lift TUC	127
BAINBRIDGE, pinces atraumatiques	268	Ciseaux pour le cartilage	104
BAINBRIDGE, pinces hémostatiques	55	Ciseaux pour nerfs	97
BALL & SOCKET, pinces a champs	67	Ciseaux super cut SC	91
BALLENGER-FOERSTER, pinces à éponges	168	Ciseaux super cut SC avec plaquettes en carbure de tungstène TUC	117
BARRAQUER, micro-porte-aiguilles à manches rondes	156	Clamps atrauma bulldog	260-263
BARRAQUER-TROUTMAN, micro porte-aiguilles à manches rondes	156	Clamps bulldog	40,41
BECK, pinces atraumatiques	283,289	CLASSON, ciseaux vasculaires	103
BECK-LUETHY, porte-aiguilles tungstène TUC	150	CLEVELAND, pinces coupantes à os	230
BENGOLEA, pinces hémostatiques	56	CLEVELAND-GARDNER, pinces coupantes à os	229
BERNHARD, pinces à champs	66	Clips	257-259
BETHUNE, costotomes	237	COLLER, pinces hémostatiques	47
BEYER, pinces-gouges	224	COLLIN, manches pour bistouris	132
BIEMER, clips vasculaires	258	CONE, écarteurs autostatiques	198
BIEMER, crochets très fins	253	CONVERSE, porte-aiguilles tungstène TUC	143
BILLROTH, écarteurs	178	COOLEY, canules d'aspiration	215
BIRKETT, pinces à dissection et à ligatures	65	COOLEY, dilatateurs	299
Bistouris	129-134	COOLEY, dilatateurs vasculaires	204
		COOLEY, écarteurs à atrium	256
		COOLEY, écarteurs des côtes	249
		COOLEY, pinces atraumatiques	285-288,291

	Page		Page
COOLEY-DERRA, pinces atraumatiques	289	E	
COOLEY-STRUCK, écarteurs à atrium	256		
CORWIN, pinces à torsader le fil tungstène TUC	151	easyClean	306-309
CORYLLOS, costotomes	237	Ecarteurs	171-198
CORYLLOS, écarteurs	192	Ecarteurs à atrium	256
Costotomes	237,238	Ecarteurs des côtes	239-250
COTTLE KAZANJIAN, pinces coupantes à os	229	Ecarteurs endoscopie	313
COUPLAND, canules d'aspiration	214	Ecarteurs fins	176
CRAFOORD, ciseaux	104	Ecarteurs spinals	176
CRAFOORD, pinces-clamps à bronches	58	ECHLIN, pinces-gouges	227
CRAFOORD-SELLORS, pinces auriculaires	57	EISELSBERG-MATHIEU, porte-aiguilles tungstène TUC	150
CRILE, crochets très fins	252	Electrodes	327,328
CRILE, pinces hémostatiques	47	Electrodes avec canule d'aspiration	314-317,320
CRILE-RANKIN, pinces hémostatiques	47	Electrodes/Aspiration/Irrigation/Canules/Trocarts	314-325
CRILE-WOOD, porte-aiguilles tungstène TUC	144	ENGL. MODELL, pinces à champs	66
CRILE-WOOD-BABY, porte-aiguilles tungstène TUC	144	EUFRATE-PASQUE, porte-aiguilles tungstène TUC	141
Crochets très fins	172-175,252,253	EWALD, pinces à dissection et à griffes	77
CUSHING, crochets très fins	172,174,252		
CUSHING, écarteurs spinals	176	F	
CUSHING, pinces à dissection et à griffes	80	FARREL, porte-coton	202
CUSHING, pinces à dissection tungstène TUC	86	FAVALORO, ciseaux vasculaires	101
CUSHING-TAYLOR, pinces à dissection tungstène TUC	86	FEIN, porte-coton	203
		FERGUSON, canules d'aspiration	216
D		FINOCCHIETTO, ciseaux	104
DALE, pinces atraumatiques	282	FINOCCHIETTO, écarteurs des côtes	241,248
DANDY, ciseaux vasculaires	101	FINOCCHIETTO, porte-aiguilles tungstène TUC	145
DANDY, pinces hémostatiques pour le cuir chevelu	54	FINOCCHIETTO-BABY, écarteurs des côtes	241
DARDIK, pinces atraumatiques	290	FINSEN, écarteurs autostatiques	194
DAVIDSON, écarteurs	193	FISCH, crochets très fins	253
DAVIS, spatules vasculaires	251	FOERSTER-BALLENGER, pinces à éponges	168
DAVIS-RAGNELL, écarteurs fins	176	FOX-GOLDMAN, ciseaux tungstène TUC	127
DE BAKEY, canules d'aspiration	213	FRANKENFELDT, pinces pour saisir	207
DE BAKEY, ciseaux tungstène TUC	123	FRAZIER, canules d'aspiration	216
DE BAKEY, ciseaux vasculaires	99,102	FRENCH-EYE-RYDER, porte-aiguilles tungstène TUC	141
DE BAKEY, clamps atrauma bulldog	260	FRYKHOLM, pinces-gouges	227
DE BAKEY, dilataeurs vasculaires	205	FULTON, ciseaux vasculaires	103
DE BAKEY, écarteurs des côtes	245,246		
DE BAKEY, pinces à dissection tungstène TUC	87	G	
DE BAKEY, pinces atrauma	84	GARRETT, dilataeurs vasculaires	204
DE BAKEY, pinces atraumatiques	267,269-273,275,279,284,295	GEISSENDOERFER-OVERHOLT, pinces à dissection et à ligatures	51
DE BAKEY, porte-aiguilles tungstène TUC	140	GEMINI, pinces à dissection et à ligatures	63
DE BAKEY-BAHNSON, pinces atraumatiques	275	GERALD, pinces à dissection et à griffes	80
DE BAKEY-CAROTIS, clamps atrauma bulldog	262	GIERTZ-STILLE, costotomes	238
DE BAKEY-HESS, clips vasculaires	259	GILLIES, crochets très fins	253
DE BAKEY-MOSQUITO, pinces atraumatiques	264	GILLIES, pinces à dissection tungstène TUC	85
DE BAKEY-PEAN, pinces atraumatiques	265	GILLIES, porte-aiguilles tungstène TUC	146
DE BAKEY-RANKIN, pinces atraumatiques	264	GIL-VERNET, écarteurs fins	175
DE BAKEY-SATINSKY, clamps atrauma bulldog	262	GLOVER, clamps atrauma bulldog	261
DE MARTEL-POTTS, ciseaux vasculaires	102	GLOVER, pinces atraumatiques	283
DEAVER, écarteurs	187-189	GLUCK, costotomes	237
DERF, porte-aiguilles tungstène TUC	143	GOLDMAN-FOX, ciseaux tungstène TUC	127
DERRA, pinces atraumatiques	282	GORNEY, ciseaux à dissection	97
DESMARRES, crochets très fins	174	GREEN-SENN, écarteurs fins	173
DIEFFENBACH, clamps bulldog	41	GREGORY, pinces atraumatiques	281
DIETRICH, micro-porte-aiguilles tungstène TUC	153	GREGORY-SOFT, clamps atrauma bulldog	263
DIETRICH-HEGEMANN, ciseaux vasculaires	100	GROSS-MAIER, pinces à pansements	166,167
DIETRICH, pinces atraumatiques	281		
Dilatateurs	299	H	
Dilatateurs vasculaires	204,205	HAIGHT, écarteurs des côtes	239
Dissection, micro-ciseaux	111,113	HALSEY, porte-aiguilles tungstène TUC	143
DIXON-LOVELACE, pinces hémostatiques	54	HALSTED, pinces hémostatiques	46
DOYEN, écarteurs	185	HALSTED-MOSQUITO, pinces hémostatiques	45
DOYEN, pinces à champs	66	HARKEN, pinces atraumatiques	276
DOYEN, rugines raspatoires	235	HARKEN, pinces vena cava	298
DOYEN, sondes	201	HARRINGTON, écarteurs	185
DUNHILL, pinces hémostatiques	50	HARTMANN, pinces hémostatiques	44
DUVAL, pinces pour saisir l'intestin	39		

	Page		Page
HEGAR, dilateurs	208,209	LANGENBECK-KOCHER, écarteurs	181
HEGAR-OLSEN, porte-aiguilles tungstène TUC	146	LANGENBECK-MINI, écarteurs fins	173
HEGEMANN-DIETHRICH, ciseaux vasculaires	100	LANGENBECK-RYDER, porte-aiguilles tungstène TUC	150
HEISS, pinces-clamps à bronches	58	LAWRENCE, pinces à dissection et à ligatures	62
HERTZLER, écarteurs des côtes	240	LEBSCHKE, costotomes	238
HF-accessoires	326-331	LEES, pinces atraumatiques	278
HOPKINS-JOHNS, clamps bulldog	41	LEKSELL-STILLE, pinces-gouges	226
HOPKINS-JOHNS, pinces à dissection et à ligatures	60	LELAND-JONES, pinces atraumatiques	268
HOPKINS-JOHNS, pinces à poser	41	LERICHE, pinces hémostatiques	46
HORNE-JOBSON, porte-coton	203	LEXER, ciseaux à dissection	97
HÖSEL, porte-aiguilles tungstène TUC	149	LEXER, ciseaux tungstène TUC	124
HOSPITAL-PROVIDENCE, pinces hémostatiques	46	LICHTENBERG, porte-aiguilles à mors en carbure de tungstène	149
I		LINCOLN, ciseaux vasculaires	103
I.M.A. MAMMARIA, écarteurs des côtes	239	LISTER, ciseaux tungstène TUC	128
Instruments des os	217-232	LISTON, pinces coupantes à os	229,232
Instruments pour Laparoscopie / Thorax	306-313	LISTON-KEY, pinces coupantes à os	231
Instruments vaisseaux et sondes	199-209	LITTAUER-LISTON, pinces coupantes à os	229
ISRAEL, écarteurs	179	LITTLER, ciseaux fins	105
J		LOCKHART-MUMMERY, sondes	202
JACOBSON, micro-porte-aiguilles	160	LORNA, pinces à champs	67
JACOBSON, micro-porte-aiguilles tungstène TUC	152	LOTH-KLINKENBERGH, ciseaux vasculaires	103
JACOBSON, porte-aiguilles tungstène TUC	142	LOVELACE, pinces-clamps à poumons	297
JANSEN, écarteurs autostatiques	194	LOVELACE-DIXON, pinces hémostatiques	54
JAVID, pinces atraumatiques	285	LUETHY-BECK, porte-aiguilles tungstène TUC	150
JEWELER, pinces à dissection tungstène TUC	85	M	
JOBSON-HORNE, porte-coton	203	MAIER-GROSS, pinces à pansements	166,167
JOHNS-HOPKINS, clamps bulldog	41	Manches pour bistouris	131-133
JOHNS-HOPKINS, pinces à dissection et à ligatures	60	MARKWALDER, pinces coupantes à os	229
JOHNS-HOPKINS, pinces à poser	41	MARQUARDT, pinces-gouges	224
JONES, pinces à champs	66	MARTIN, écarteurs	184
JOSEPH, ciseaux à dissection	98	MARTIN-CARTILAGE, ciseaux	104
K		MASSON, porte-aiguilles tungstène TUC	145
KADER, écarteurs	191	MATHIEU, porte-aiguilles tungstène TUC	147
KALT, micro-porte-aiguilles tungstène TUC	153	MATHIEU-DELICATE, porte-aiguilles tungstène TUC	147
KANTROWITZ, pinces à dissection et à ligatures	63	MATHIEU-EISELSBERG, porte-aiguilles tungstène TUC	150
KAYE, ciseaux pour Face-lift TUC	127	MATHIEU-RYDER VASCULAR, porte-aiguilles tungstène TUC	148
KELLY, écarteurs	186	MATHIEU-RYDER, porte-aiguilles tungstène TUC	148
KELLY, pinces hémostatiques	47	MATSON, rugines raspatoires	233
KELLY-RANKIN, pinces hémostatiques	47	MAYFIELD, pinces-gouges	224
KILNER (RAGNELL), ciseaux à dissection	98	MAYO, ciseaux tungstène TUC	119
KILNER, crochets très fins	253	MAYO-HEGAR, porte-aiguilles tungstène TUC	140
KILNER, porte-aiguilles tungstène TUC	143	MAYO-HEGAR-DELICATE, porte-aiguilles tungstène TUC	140
KLINIKUM BERLIN, presses-tube	68	MC INDOE, ciseaux	104
KLINKENBERGH-LOTH, ciseaux vasculaires	103	MC INDOE, pinces à dissection	77
KOCHER, écarteurs	177,182	MC INDOE, pinces coupantes à os	230
KOCHER-DELICATE, pinces hémostatiques	50	MEEKER, pinces à dissection et à ligatures	53
KOCHER-LANGENBECK, écarteurs	181	MEHDORN, clips vasculaires	258
KOCHER-OCHSNER, pinces hémostatiques	49	METZENBAUM, ciseaux tungstène TUC	121,122
KOERTE, écarteurs	178,189	METZENBAUM, porte-aiguilles tungstène TUC	147
KRAYENBÜHL, crochets très fins	252	METZENBAUM-DELICATE, ciseaux à dissection	96
KROENLEIN, pinces hémostatiques	43	METZENBAUM-DELICATE, ciseaux tungstène TUC	124-126
L		METZENBAUM-NELSON, ciseaux à dissection	95
LAMBERT-KAY, pinces atraumatiques	275	MEYERDING, écarteurs fins	173
LAMBOTTE, rugines raspatoires	236	MICRO-ADSON, pinces à dissection et à griffes	76
Lames de bistouris	133,134	Micro-ciseaux	110-116
LANDOLT, ciseaux fins	106	Micro-ciseaux, Adventitia	111,113
LANE, pinces à champs	66	Micro-ciseaux, Dissection	111,113
LANE, pinces à griffes	79	Micro-ciseaux, Nerve	113
LANGENBECK, écarteurs	180	MICRO-MOSQUITO, pinces hémostatiques	45
LANGENBECK, porte-aiguilles tungstène TUC	150	Micro-pinces	82,83
LANGENBECK-DELICATE, porte-aiguilles tungstène TUC	150	Micro-porte-aiguilles	160,161
		Micro-porte-aiguilles à manches rondes	156-159
		Micro-porte-aiguilles tungstène TUC	152,153
		MICRO-RYDER, porte-aiguilles tungstène TUC	141
		MICROVASCULAR, porte-aiguilles tungstène TUC	141
		MIKULICZ, écarteurs	186
		MILLS, ciseaux vasculaires	102

	Page		Page
MINI, lames de bistouris	133	Pincés hémostatiques pour amygdales	55
MINI, manches de bistouris	133	Pincés micro	82,83
MINI-LANGENBECK, écarteurs fins	173	Pincés monopolaires	329
MIXTER, pincés à dissection et à ligatures	61,62	Pincés pour la bi-coagulation	331
MIXTER-BABY, pincés à dissection et à ligatures	61	Pincés pour saisir le tissu	38
MIXTER-O'SHAUGNESSY, pincés à dissection et à ligatures	61	Pincés pour saisir l'intestin	39
MIXTER-OVERHOLT, pincés à dissection et à ligatures	57	Pincés vena cava	298
MOD. BONN, ciseaux fins	106	Pincés-clamps à bronches	58,297
MODELL TÜBINGEN, écarteurs	184	Pincés-clamps à poumons	297
MOLDESTAD, crochets très fins	172	Pincés-gouges	224-228
MORRIS, écarteurs	183	Plaquettes en carbure de tungstène avec profil pyramidal	136,137
MORRIS-DE BAKEY, pincés atraumatiques	280	PLESTER, canules d'aspiration	216
MORSE FAVALORO, écarteurs des côtes	247	POOLE, canules d'aspiration	214
MOSQUITO-HALSTED, pincés hémostatiques	45	POOLE-BABY, canules d'aspiration	214
MOSQUITO-MICRO, pincés hémostatiques	45	Porte-aiguilles à mors en carbure de tungstène	140-155
MÜLLER, clips vasculaires	259	Porte-coton	202,203
MUMMERY-LOCKHART, sondes	202	POTTS, pincés atraumatiques	266
MYRTLE LEAF, sondes	201	POTTS-DE MARTEL, ciseaux vasculaires	102
		POTTS-SMITH, ciseaux	104
N		POTTS-SMITH, ciseaux tungstène TUC	123
NABATOFF, trousse à varices	203	POTTS-SMITH, ciseaux vasculaires	99,101
NEIVERT, porte-aiguilles tungstène TUC	143	POTTS-SMITH, micro-porte-aiguilles tungstène TUC	153
NELATON, sondes	201	POTTS-SMITH, pincés à dissection et à griffes	81
NELSON-METZENBAUM, ciseaux à dissection	95	POTTS-SMITH, pincés à dissection tungstène TUC	85
Nerve, micro-ciseaux	113	PRATT, sonde fistulaire	202
NEW ORLEANS, porte-aiguilles tungstène TUC	142	PRESBYTERIAN, presses-tube	68
nopa DIAMOND, porte-aiguilles	154,155	Presses-tube	68
		PRICE-THOMAS, pincés-clamps à bronches	297
O		PROVIDENCE-HOSPITAL, pincés hémostatiques	46
O'BRIEN, ciseaux fins	106	PYNCHON-ANDREWS, canules d'aspiration	213
OCHSNER, pincés atraumatiques	281		
OCHSNER-KOCHER, pincés hémostatiques	49	R	
OEHLER, pincés à dissection tungstène TUC	85	RAGNELL (KILNER), ciseaux à dissection	98
OLLIER, écarteurs	179	RAGNELL-DAVIS, écarteurs fins	176
OLSEN-HEGAR, porte-aiguilles tungstène TUC	146	RAMPLEY, pincés à éponges	169
Optiques	304,305	RANKIN-CRILE, pincés hémostatiques	47
O'SHAUGNESSY-MIXTER, pincés à dissection et à ligatures	61	RANKIN-KELLY, pincés hémostatiques	47
OVERHOLT, pincés à disséquer et à ligatures	52	Rapprocheurs des côtes	254
OVERHOLT-BABY, pincés à dissection et à ligatures	51	REILL, micro-porte-aiguilles à manches rondes	157
OVERHOLT-GEISSENDOERFER, pincés à dissection et à ligatures	51	REYNOLDS, ciseaux à dissection	98
OVERHOLT-MIXTER, pincés à dissection et à ligatures	57	ROBERTS, pincés-clamps à bronches	58
		ROCHESTER-CARMALT, pincés hémostatiques	55
P		ROCHESTER-PEAN, pincés hémostatiques	48
PEAN, pincés hémostatiques	43	ROEDER, pincés à champs	67
PEAN-DELICATE, pincés hémostatiques	50	ROETTGEN-RUSKIN, pincés-gouges	226
PEAN-ROCHESTER, pincés hémostatiques	48	Rugines raspatoires	235,236
PEERS, pincés à champs	67	RUMEL, pincés à dissection et à ligatures	59
PENFIELD, spatules	251	RUMEL-BELMONT, tourniquets	299
Pincés	71-87	RUSKIN, pincés-gouges	224,228
Pincés à champs	66,67	RUSKIN-LISTON, pincés coupantes à os	230
Pincés à compresses	66,67	RYDER MICRO, porte-aiguilles tungstène TUC	141
Pincés à dissection avec mors en carbure de tungstène	85-87	RYDER-FRENCH EYE, porte-aiguilles tungstène TUC	141
Pincés à disséquer et à ligatures	51-53,57,59-65	RYDER-LANGENBECK, porte-aiguilles tungstène TUC	150
Pincés à fil	222,223	RYDER-MATHIEU VASCULAR, porte-aiguilles tungstène TUC	148
Pincés à ligatures avec plate-forme	82,83	RYDER-MATHIEU, porte-aiguilles tungstène TUC	148
Pincés à pansements	163-169		
Pincés à poser	41	S	
Pincés à préhension endoscopie	307-312	SANTULLI, clamps atrauma bulldog	260
Pincés à torsader le fil tungstène TUC	151	SANVENERO, ciseaux à dissection	98
Pincés atrauma	84	SAROT, pincés-clamps à bronches	58
Pincés atraumatiques	264-296	SAROT, porte-aiguilles tungstène TUC	145
Pincés auriculaires	57	SATINSKY, ciseaux vasculaires	103
Pincés coupantes à os	229-232	SATINSKY, pincés atraumatiques	272,274
Pincés hémostatiques	35-68	SATINSKY, pincés vena cava	298
Pincés hémostatiques fines	45	SAUERBRUCH, costotomes	237
Pincés hémostatiques graciles	50	SAUERBRUCH, écarteurs	182,192
		SAUERBRUCH, pincés-gouges	227

	Page		Page
SAWTELL-SCHNIDT, pinces hémostatiques pour amygdales	55	Trocards à manche et trocards	321-325
SCHAEDEL, pinces à champs	66	Trousse à varices	203
SCHMID, spatules vasculaires	251	TROUTMAN, micro-porte-aiguilles à manches rondes	157
SCHMIEDEN-TAYLOR, ciseaux vasculaires	102	TROUTMAN-BARRAQUER, micro-porte-aiguilles à manches rondes	156
SCHNIDT-SAWTELL, pinces hémostatiques pour amygdales	55	TUBBS, dilataateurs	299
SELLORS, rapprocheurs des côtes	254	Tubes d'aspiration et canules	211-216
SELLORS-CRAFOORD, pinces auriculaires	57	TÜBINGER MODELL, écarteurs	184
SEMB, pinces coupantes à os	232	TUDOR-EDWARDS, pinces coupantes à os	231
SEMB, pinces-clamps à bronches	297	TUFFIER, écarteurs	185
SEMB, pinces-gouges	225	TUFFIER, écarteurs des côtes	240
SEMB, rugines-raspatoires	236	TUFFIER, pinces hémostatiques	42
SEMKEN, pinces à dissection et à griffes	77,78	U	
SEMKEN, pinces à dissection tungstène TUC	85	UCKERMANN, porte-coton	203
SENN-GREEN, écarteurs fins	173	ULRICH, pinces à pansements	165
SENNING (SWEDISH PATTERN), porte-aiguilles tungstène TUC	142	UNIVERSAL, ciseaux tungstène TUC	128
SENN-MILLER, écarteurs fins	176	V	
SENN-MILLER-BABY, écarteurs fins	176	VERNET-GIL, écarteurs fins	175
SIMON, écarteurs	184	VOLKMANN, écarteurs	177,178
SMITH-PETERSON, pinces-gouges	228	W	
SMITH-POTTS, ciseaux	104	WALTON, ciseaux fins	106
SMITH-POTTS, ciseaux vasculaires	99,101	WALTON-LISTON, pinces coupantes à os	230
SMITH-POTTS, micro-porte-aiguilles tungstène TUC	153	WALTON-YANKAUER, canules d'aspiration	213
SMITH-POTTS, pinces à dissection et à griffes	81	WANGENSTEEN, pinces à dissection tungstène TUC	87
SNITMAN, écarteurs autostatiques	194	WANGENSTEEN, porte-aiguilles tungstène TUC	145
Sondes	201,202	WEBER, pinces atraumatiques	277
Sondes et instruments vaisseaux	199-209	WEBSTER, porte-aiguilles tungstène TUC	143
Sources à lumière froide	332-338	WEITLANER, écarteurs autostatiques	195
Spatules	251	WEITLANER-BABY, écarteurs autostatiques	195
Spatules pulmonaires	255	WELLS-SPENCER, pinces hémostatiques	44
SPENCER-WELLS, pinces hémostatiques	44	WERTHEIM, porte-aiguilles tungstène TUC	146
STACKE, sondes	201	WIKSTROEM, pinces à dissection et à ligatures	65
STANDARD, ciseaux tungstène TUC	118,119	Y	
STANDARD, pinces à dissection	75	YANKAUER, canules d'aspiration	213
STANDARD, pinces à griffes	75	YANKAUER-WALTON, canules d'aspiration	213
STERNUM, pinces à torsader le fil tungstène TUC	151	Z	
STEVENS, ciseaux à ténonomie	109	ZAUFAL-JANSEN, pinces-gouges	224
STEVENS, ciseaux tungstène TUC	127	ZENKER, écarteurs	190
STILLE, pinces-gouges	225	ZENKER, pinces à dissequer et à ligatures	60
STILLE-LISTON, pinces coupantes à os	231	ZWEIFEL, porte-aiguilles tungstène TUC	150
STILLE-LUER, pinces-gouges	226		
STILLE-RUSKIN, pinces-gouges	225		
STRATTE, porte-aiguilles tungstène TUC	145		
STRULLY, ciseaux vasculaires	101		
SUBRAMANIAN, pinces atraumatiques	296		
SUBRAMANIAN-MINIATURE, pinces atraumatiques	296		
SULLIVAN (BROPHY), ciseaux fins	105		
Super Cut ciseaux SC	91		
Suture	135-161		
Système de bras articulé avec fixage rapide central	342,343		
T			
TAYLOR, écarteurs spinals	176		
TAYLOR, pinces à dissection et à griffes	78,79		
TAYLOR-CUSHING, pinces à dissection tungstène TUC	86		
TAYLOR-SCHMIEDEN, ciseaux vasculaires	102		
TERRIER, pinces hémostatiques	44		
tini instruments (titan-nitride surface coating)	69,70		
Tire-veines	206		
titan instruments	37,73,93,116,139		
TOENNIS, ciseaux vasculaires	102		
TOENNIS, pinces à dissection et à ligatures	64		
TOENNIS, porte-aiguilles tungstène TUC	149		
TOENNIS-ADSON, ciseaux vasculaires	102		
TOENNIS-ADSON-DELICATE, ciseaux tungstène TUC	127		
TOHOKU-JAPAN, pinces à champs	67		
TÖNNIS, spatules vasculaires	251		
Toracoscopie	301-343		
Tourniquets	299		

Indice alfabetico

	Pagina		Pagina
A		BILLROTH, divaricatori	178
Accessori per power drills	220	BIRKETT, pinze per preparazioni e legature	65
Accu power drill	219	Bisturi	129-134
Accumulatore / Caricabatteria per power drills	221	BONNEY, pinze tungsteno TUC	87
Adattatore	333	BOYNTON, portaghi tungsteno TUC	149
ADSON, cannule per aspirazione	216	BOZEMANN, portaghi tungsteno TUC	145
ADSON, divaricatori autostatici	196,197	BRIDGE, pinze per preparazioni e legature	62
ADSON, pinze	76,77	BRODIE, sonde	202
ADSON, pinze emostatiche	53	BROM, divaricatori sottili	252
ADSON, pinze tungsteno TUC	86	BROPHY (SULLIVAN), forbici fine	105
ADSON-ANDERSON, divaricatori autostatici	196	BROPHY, pinze anatomiche e chirurgiche	81
ADSON-BABY, divaricatori autostatici	198	BROWN-ADSON, pinze anatomiche e chirurgiche	77
ADSON-BABY, pinze emostatiche	53	BRUNNER, costotomi	238
ADSON-BROWN, pinze anatomiche e chirurgiche	77	BULLDOG, pinze	40,41
ADSON-MICRO, pinze anatomiche e chirurgiche	76	BURFORD, divaricatori costali	250
ADSON-TOENNIS, forbici	102	BYRD, cannule per aspirazione	214
ADSON-TOENNIS-DELICATE, forbici tungsteno TUC	127	C	
Adventitia, micro forbici	111,113	CAIRNS, pinze emostatiche	50
AF-accessori	326-331	Cannule e tubi d'aspirazione	211-216
Air power drill	219	Cannule per aspirazione endoscopia	318,319
ALEXANDER, periostotomi costali	235	Cardiovascolare	233-299
ALLIS, pinze per afferrare tessuti	38	CARMALT-ROCHESTER, pinze emostatiche	55
ALLIS-ADAIR, pinze per afferrare tessuti	38	CARREL, pinze emostatiche	44
ALLIS-BABY, pinze per afferrare tessuti	38	CARROLL, portaghi tungsteno TUC	142
ALLISON, spatole per polmone	255	CARTILAGE-MARTIN, forbici	104
ALM, divaricatori autostatici	194	CASTANEDA, divaricatori costali	249
ANDERSON-ADSON, divaricatori autostatici	196	CASTANEDA, pinze atrauma	294
ANDREWS-PYNCHON, cannule per aspirazione	213	CASTROVIEJO, micro-portaghi	160
ANKENEY, divaricatori costali	242,243	CASTROVIEJO, micro-portaghi tungsteno TUC	152,153
Approssimatori costali	254	Cavi da connessione	326
ARRUGA, portaghi tungsteno TUC	149	Cavi fibra ottica	332
Astuccio per varici	203	Cesoie per ossa	229-232
AUSTIN, pinze per legature	82	CHAPUT, pinze emostatiche	42
B		CHURCH, forbici	103
BABCOCK, pinze per afferrare l'intestino	39	CLASSON, forbici	103
BABY-ADSON, pinze emostatiche	53	CLEVELAND, cesoie per ossa	230
BABY-CRILE-WOOD, portaghi tungsteno TUC	144	CLEVELAND-GARDNER, cesoie per ossa	229
BABY-MIXTER, pinze per preparazioni e legature	61	Clips	257-259
BABY-OVERHOLT, pinze per preparazioni e legature	51	COLLER, pinze emostatiche	47
BABY-POOLE, cannule per aspirazione	214	COLLIN, manici per bisturi	132
BABY-SATINSKY, pinze cava vena	298	CONE, divaricatori autostatici	198
BABY-SENN-MILLER, divaricatori sottili	176	CONVERSE, portaghi tungsteno TUC	143
BABY-WEITLANER, divaricatori autostatici	195	COOLEY, cannule per aspirazione	215
BACKHAUS, pinze per fissare le compresse (Fissatele)	67	COOLEY, dilatatori	299
BADGLEY, divaricatori costali	240	COOLEY, dilatatori per vasi	204
BAILEY, approssimatori costali	254	COOLEY, divaricatori atriali	256
BAILEY-BABY, approssimatori costali	254	COOLEY, divaricatori costali	249
BAILEY-GIBBON, approssimatori costali	254	COOLEY, pinze atrauma	285-288,291
BAINBRIDGE, pinze atrauma	268	COOLEY-DERRA, pinze atrauma	289
BAINBRIDGE, pinze emostatiche	55	COOLEY-STRUCK, divaricatori atriali	256
BALL & SOCKET, pinze per fissare le compresse (Fissatele)	67	CORWIN, pinze per ritorcere TUC	151
BALLENGER-FOERSTER, pinze per spugne	168	CORYLLOS, costotomi	237
BARRAQUER, micro-portaghi con manici rotondi	156	CORYLLOS, divaricatori	192
BARRAQUER-TROUTMAN, micro-portaghi con manici rotondi	156	Costotomi	237,238
BECK, pinze atrauma	283,289	COTTLE KAZANJIAN, cesoie per ossa	229
BECK-LUETHY, portaghi tungsteno TUC	150	COUPLAND, cannule per aspirazione	214
BENGOLEA, pinze emostatiche	56	CRAFOORD, forbici	104
BERNHARD, pinze per fissare le compresse (Fissatele)	66	CRAFOORD, pinze per bronchi	58
BETHUNE, costotomi	237	CRAFOORD-SELLORS, pinze auricolari	57
BEYER, pinze-sgorbie	224	CRILE, divaricatori sottili	252
BIEMER, clips vascolari	258	CRILE, pinze emostatiche	47
BIEMER, divaricatori sottili	253	CRILE-RANKIN, pinze emostatiche	47
		CRILE-WOOD, portaghi tungsteno TUC	144

	Pagina		Pagina
CRILE-WOOD-BABY, portaghi tungsteno TUC	144		
CUSHING, divaricatori sottili	172,174,252	F	
CUSHING, divaricatori spinali	176		
CUSHING, pinze anatomiche e chirurgiche	80	FARRELL, portacotone	202
CUSHING, pinze tungsteno TUC	86	FAVALORO, forbici	101
CUSHING-TAYLOR, pinze tungsteno TUC	86	FEIN, portacotone	203
		FERGUSSON, cannule per aspirazione	216
D		FINOCCHIETTO, divaricatori costali	241,248
		FINOCCHIETTO, forbici	104
DALE, pinze atrauma	282	FINOCCHIETTO, portaghi tungsteno TUC	145
DANDY, forbici	101	FINOCCHIETTO-BABY, divaricatori costali	241
DANDY, pinze per il cuoio capelluto	54	FINSEN, divaricatori autostatici	194
DARDIK, pinze atrauma	290	FISCH, divaricatori sottili	253
DAVIDSON, divaricatori	193	FOERSTER-BALLENGER, pinze per spugne	168
DAVIS, spatole vascolari	251	Forbici	89-128
DAVIS-RAGNELL, divaricatori sottili	176	Forbici con taglio al carburo di tungsteno	118-128
DE BAKEY, cannule per aspirazione	213	Forbici coronaria	101
DE BAKEY, dilatatori per vasi	205	Forbici Face-lift TUC	127
DE BAKEY, divaricatori costali	245,246	Forbici fini	105-109
DE BAKEY, forbici per chirurgia vascolare	99,102	Forbici micro	110-116
DE BAKEY, forbici tungsteno TUC	123	Forbici per anatomia	104
DE BAKEY, pinze atrauma	84	Forbici per cartilagini	104
DE BAKEY, pinze atrauma	267,269-273,275,279,284,295	Forbici per chirurgia vascolare	99-103
DE BAKEY, pinze atrauma bulldog	260	Forbici per episiotomia	104
DE BAKEY, pinze tungsteno TUC	87	Forbici per iridectomia	107
DE BAKEY, portaghi tungsteno TUC	140	Forbici per lobectomia	104
DE BAKEY-BAHNSON, pinze atrauma	275	Forbici per nervi	97
DE BAKEY-CAROTIS, pinze atrauma bulldog	262	Forbici per preparazioni	95-98
DE BAKEY-HESS, clips vascolari	259	Forbici Super-Cut SC	91
DE BAKEY-MOSQUITO, pinze atrauma	264	Forbici Super-Cut SC con taglio al carburo di tungsteno TUC	117
DE BAKEY-PEAN, pinze atrauma	265	FRANKENFELDT, pinze per afferrare	207
DE BAKEY-RANKIN, pinze atrauma	264	FRAZIER, cannule per aspirazione	216
DE BAKEY-SATINSKY, pinze atrauma bulldog	262	FRENCH-EYE-RYDER, portaghi tungsteno TUC	141
DE MARTEL-POTTS, forbici	102	FRYKHOLM, pinze-sgorbie	227
DEAVER, divaricatori	187-189	FULTON, forbici	103
DERF, portaghi tungsteno TUC	143		
DERRA, pinze atrauma	282	G	
DESMARRES, divaricatori sottili	174		
DIEFFENBACH, pinze bulldog	41	GARETT, dilatatori per vasi	204
DIETHRICH, micro-portaghi tungsteno TUC	153	GEISSENDOERFER-OVERHOLT, pinze per preparazioni e legatura	51
DIETHRICH-HEGEMANN, forbici per chirurgia vascolare	100	GEMINI, pinze per preparazioni e legatura	63
DIETRICH, pinze atrauma	281	GERALD, pinze anatomiche e chirurgiche	80
Dilatatori	299	GIERTZ-STILLE, costotomi	238
Dilatatori per vasi	204,205	GILLIES, divaricatori sottili	253
Dissection, micro forbici	111,113	GILLIES, pinze tungsteno TUC	85
Divaricatori	171-198	GILLIES, portaghi tungsteno TUC	146
Divaricatori atriali	256	GIL-VERNET, divaricatori sottili	175
Divaricatori endoscopia	313	GLOVER, pinze atrauma	283
Divaricatori sottili	172-176,252,253	GLOVER, pinze atrauma bulldog	261
Divaricatori spinali	176	GLUCK, costotomi	237
DIXON-LOVELACE, pinze emostatiche	54	GOLDMAN-FOX, forbici tungsteno TUC	127
DOYEN, divaricatori	185	GORNEY, forbici per preparazioni	97
DOYEN, periostotomi costali	235	GREEN-SENN, divaricatori sottili	173
DOYEN, pinze per fissare le compresse (Fissatele)	66	GREGORY, pinze atrauma	281
DOYEN, sonde	201	GREGORY-SOFT, pinze atrauma bulldog	263
DUNHILL, pinze emostatiche	50	GROSS-MAIER, pinze per polipi	166,167
DUVAL, pinze per afferrare l'intestino	39		
		H	
E			
easyClean	306-309	HAIGHT, divaricatori costali	239
ECHLIN, pinze-sgorbie	227	HALSEY, portaghi tungsteno TUC	143
EISELSBERG-MATHIEU, portaghi tungsteno TUC	150	HALSTED, pinze emostatiche	46
Elettrodi	327,328	HALSTED-MOSQUITO, pinze emostatiche	45
Elettrodi con tubo d'aspirazione	314-317,320	HARKEN, pinze atrauma	276
Elettrodi/Aspirazione/Irrigazione/Aghi speciali/Trequarti	314-325	HARKEN, pinze vena cava	298
ENGL. MODELL, pinze per fissare le compresse (Fissatele)	66	HARRINGTON, divaricatori	185
EUFRATE-PASQUE, portaghi tungsteno TUC	141	HARTMANN, pinze emostatiche	44
EWALD, pinze anatomiche e chirurgiche	77	HEGAR, dilatatori	208,209
		HEGAR-OLSEN, portaghi tungsteno TUC	146

	Pagina		Pagina
HEGEMANN-DIETRICH, forbici per chirurgia vascolare	100	LEKSELL-STILLE, pinze-sgorbie	226
HEISS, pinze emostatiche	58	LELAND-JONES, pinze atrauma	268
HERTZLER, divaricatori costali	240	LERICHE, pinze emostatiche	46
HOPKINS-JOHNS, pinze bulldog	41	LEXER, forbici per preparazioni	97
HOPKINS-JOHNS, pinze per posizionare	41	LEXER, forbici tungsteno TUC	124
HOPKINS-JOHNS, pinze per preparazioni e legatura	60	LICHTENBERG, portaghi tungsteno TUC	149
HORNE-JOBSON, portacotone	203	LINCOLN, forbici	103
HÖSEL, portaghi tungsteno TUC	149	LISTER, forbici tungsteno TUC	128
HOSPITAL-PROVIDENCE, pinze emostatiche	46	LISTON, cesoie per ossa	229,232
I		LISTON-KEY, cesoie per ossa	231
I.M.A. MAMMARIA, divaricatori costali	239	LITTAUER-LISTON, cesoie per ossa	229
ISRAEL, divaricatori	179	LITTLER, forbici fini	105
J		LOCKHART-MUMMERY, sonda	202
JACOBSON, micro-portaghi	160	LORNA, pinze per fissare le compresse (Fissatele)	67
JACOBSON, micro-portaghi tungsteno TUC	152	LOTH-KLINKENBERGH, forbici	103
JACOBSON, portaghi tungsteno TUC	142	LOVELACE, pinze per polmoni	297
JANSEN, divaricatori autostatici	194	LOVELACE-DIXON, pinze emostatiche	54
JAVID, pinze atrauma	285	LUETHY-BECK, portaghi tungsteno TUC	150
JEWELER, pinze tungsteno TUC	85	M	
JOBSON-HORNE, portacotone	203	Macchine fotografiche	339-341
JOHNS-HOPKINS, pinze bulldog	41	Manici per bisturi	131-133
JOHNS-HOPKINS, pinze per posizionare	41	Manicotti tre quarti e tre quarti	321-325
JOHNS-HOPKINS, pinze per preparazioni e legatura	60	MARKWALDER, cesoie per ossa	229
JONES, pinze per fissare le compresse (Fissatele)	66	MARQUARDT, pinze-sgorbie	224
JOSEPH, forbici per preparazioni	98	MARTIN, divaricatori	184
K		MARTIN-CARTILAGE, forbici	104
KADER, divaricatori	191	MASSON, portaghi tungsteno TUC	145
KALT, micro-portaghi tungsteno TUC	153	MATHIEU, portaghi tungsteno TUC	147
KANTROWITZ, pinze per preparazioni e legature	63	MATHIEU-DELICATE, portaghi tungsteno TUC	147
KAYE, forbici Face-lift	127	MATHIEU-EISELSBERG, portaghi tungsteno TUC	150
KELLY, divaricatori	186	MATHIEU-RYDER VASCULAR, portaghi tungsteno TUC	148
KELLY, pinze emostatiche	47	MATHIEU-RYDER, portaghi tungsteno TUC	148
KELLY-RANKIN, pinze emostatiche	47	MATSON, periostotomi costali	235
KILNER (RAGNELL), forbici per preparazioni	98	MAYFIELD, pinze-sgorbie	224
KILNER, divaricatori sottili	253	MAYO, forbici tungsteno TUC	119
KILNER, portaghi tungsteno TUC	143	MAYO-HEGAR, portaghi tungsteno TUC	140
KLINIKUM BERLIN, pinze serratubi	68	MAYO-HEGAR-DELICATE, portaghi tungsteno TUC	140
KLINKENBERGH-LOTH, forbici	103	MC INDOE, cesoie per ossa	230
KOCHER, divaricatori	177,182	MC INDOE, forbici	104
KOCHER-DELICATE, pinze emostatiche	50	MC INDOE, pinze anatomiche e chirurgiche	77
KOCHER-LANGENBECK, divaricatori	181	MEEKER, pinze per preparazioni e legature	53
KOCHER-OCHSNER, pinze emostatiche	49	MEHDORN, clips vascolari	258
KOERTE, divaricatori	178,189	METZENBAUM, forbici tungsteno TUC	121,122
KRAYENBÜHL, divaricatori sottili	252	METZENBAUM, portaghi tungsteno TUC	147
KROENLEIN, pinze emostatiche	43	METZENBAUM-DELICATE, forbici per preparazioni	96
L		METZENBAUM-DELICATE, forbici tungsteno TUC	124-126
LAMBERT-KAY, pinze atrauma	275	METZENBAUM-NELSON, forbici per preparazioni	95
LAMBOTTE, periostotomi costali	236	MEYERDING, divaricatori sottili	173
Lame per bisturi	133,134	Micro forbici	110-116
LANDOLT, forbici fini	106	Micro forbici Adventitia	111,113
LANE, pinze anatomiche e chirurgiche	79	Micro forbici Dissection	111,113
LANE, pinze per fissare le compresse (Fissatele)	66	Micro forbici Nerve	113
LANGENBECK, divaricatori	180	Micro pinze	82,83
LANGENBECK, portaghi tungsteno TUC	150	MICRO-ADSON, pinze anatomiche e chirurgiche	76
LANGENBECK-DELICATE, portaghi tungsteno TUC	150	MICRO-MOSQUITO, pinze emostatiche	45
LANGENBECK-KOCHER, divaricatori	181	Micro-portaghi	160,161
LANGENBECK-MINI, divaricatori sottili	173	Micro-portaghi con manici rotondi	156-159
LANGENBECK-RYDER, portaghi tungsteno TUC	150	Micro-portaghi con placche di carburo di tungsteno TUC	152,153
LAWRENCE, pinze per preparazioni e legature	62	MICRO-RYDER, portaghi tungsteno TUC	141
LEBSCHKE, costotomi	238	MICROVASCULAR, portaghi tungsteno TUC	141
LEES, pinze atrauma	278	MIKULICZ, divaricatori	186
		MILLS, forbici	102
		MINI, lame per bisturi	133
		MINI, manici per bisturi	133
		MINI-LANGENBECK, divaricatori sottili	173
		MIXTER, pinze per preparazioni e legature	61,62
		MIXTER-BABY, pinze per preparazioni e legature	61

	Pagina		Pagina
MIXTER-O'SHAUGNESSY, pinze per preparazioni e legature	61	Pinze per posizionare	41
MIXTER-OVERHOLT, pinze per preparazioni e legature	57	Pinze per preparazioni e legature	51-53,57,59-65
MOD. BONN, forbici fini	106	Pinze per ritorcere fili TUC	151
MODELL TÜBINGEN, divaricatori	184	Pinze serratubi	68
MOLDESTAD, divaricatori sottili	172	Pinze vena cava	298
MORRIS, divaricatori	183	Pinze-sgorbie	224-228
MORRIS-DE BAKEY, pinze atrauma	280	Placche di carburo di tungsteno con profilo in forma piramidale	136,137
MORSE FAVALORO, divaricatori costali	247	PLESTER, cannule per aspirazione	216
MOSQUITO-HALSTED, pinze emostatiche	45	POOLE, cannule per aspirazione	214
MOSQUITO-MICRO, pinze emostatiche	45	POOLE-BABY, cannule per aspirazione	214
MÜLLER, clips vascolari	259	Portacotone	202,203
MYRTLE-LEAF, sonde	201	Portaghi con placche di carburo di tungsteno	140-155
N		POTTS, pinze atrauma	266
NABATOFF, astuccio per varici	203	POTTS-DE MARTEL, forbici	102
NEIVERT, portaghi tungsteno TUC	143	POTTS-SMITH, forbici	104
NELATON, sonde	201	POTTS-SMITH, forbici per chirurgia vascolare	99,101
NELSON-METZENBAUM, forbici per preparazioni	95	POTTS-SMITH, forbici tungsteno TUC	123
Nerve, micro forbici	113	POTTS-SMITH, micro-portaghi tungsteno TUC	153
NEW ORLEANS, portaghi tungsteno TUC	142	POTTS-SMITH, pinze anatomiche e chirurgiche	81
nopa DIAMOND, portaghi	154,155	POTTS-SMITH, pinze tungsteno TUC	85
O		PRATT, sonda per fistule	202
O'BRIEN, forbici fini	106	PRESBYTERIAN, pinze serratubi	68
OCHSNER, pinze atrauma	281	PRICE-THOMAS, pinze per bronchi	297
OCHSNER-KOCHER, pinze emostatiche	49	PROVIDENCE-HOSPITAL, pinze emostatiche	46
OEHLER, pinze tungsteno TUC	85	PYNCHON-ANDREWS, cannule per aspirazione	213
OLLIER, divaricatori	179	R	
OLSEN-HEGAR, portaghi tungsteno TUC	146	RAGNELL (KILNER), forbici per preparazioni	98
O'SHAUGNESSY-MIXTER, pinze per preparazioni e legature	61	RAGNELL-DAVIS, divaricatori sottili	176
Ottiche	304,305	RAMPLEY, pinze per spugne	169
OVERHOLT, pinze per preparazioni e legature	52	RANKIN-CRILE, pinze emostatiche	47
OVERHOLT-BABY, pinze per preparazioni e legature	51	RANKIN-KELLY, pinze emostatiche	47
OVERHOLT-GEISSENDOERFER, pinze per preparazioni e legature	51	REILL, micro-portaghi con manici rotondi	157
OVERHOLT-MIXTER, pinze per preparazioni e legature	57	REYNOLDS, forbici per preparazioni	98
P		ROBERTS, pinze emostatiche	58
PEAN, pinze emostatiche	43	ROCHESTER-CARMALT, pinze emostatiche	55
PEAN-DELICATE, pinze emostatiche	50	ROCHESTER-PEAN, pinze emostatiche	48
PEAN-ROCHESTER, pinze emostatiche	48	ROEDER, pinze per fissare le compresse (Fissatele)	67
PEERS, pinze per fissare le compresse (Fissatele)	67	ROETTGEN-RUSKIN, pinze-sgorbie	226
PENFIELD, spatole	251	RUMEL, pinze per preparazioni e legature	59
Periostotomi costali	235,236	RUMEL-BELMONT, tornichetti	299
Pinze da presa endoscopia	307-312	RUSKIN, pinze-sgorbie	224,228
Pinze	71-87	RUSKIN-LISTON, cesoie per ossa	230
Pinze atrauma	84	RYDER-FRENCH-EYE, portaghi tungsteno TUC	141
Pinze atrauma	264-296	RYDER-LANGENBECK, portaghi tungsteno TUC	150
Pinze atrauma bulldog	260-263	RYDER-MATHIEU VASCULAR, portaghi tungsteno TUC	148
Pinze auricolari	57	RYDER-MATHIEU, portaghi tungsteno TUC	148
Pinze bulldog	40,41	RYDER-MICRO, portaghi tungsteno TUC	141
Pinze emostatiche	35-68	S	
Pinze emostatiche delicate	50	SANTULLI, pinze atrauma bulldog	260
Pinze emostatiche fine	45	SANVENERO, forbici per preparazioni	98
Pinze emostatiche per tonsille	55	SAROT, pinze per bronchi	58
Pinze micro	82,83	SAROT, portaghi tungsteno TUC	145
Pinze monopolari	329	SATINSKY, forbici	103
Pinze per afferrare l'intestino	39	SATINSKY, pinze atrauma	272,274
Pinze per afferrare tessuti	38	SATINSKY, pinze cava vena	298
Pinze per bronchi	58,297	SAUERBRUCH, costotomi	237
Pinze per dissezione con punte di carburo di tungsteno TUC	85-87	SAUERBRUCH, divaricatori	182,192
Pinze per fissare le compresse (Fissatele)	66,67	SAUERBRUCH, pinze-sgorbie	227
Pinze per la bi-coagulazione	331	SAWTELL-SCHNIDT, pinze emostatiche per tonsille	55
Pinze per legature con piattaforma	82,83	SCHAEDEL, pinze per fissare le compresse (Fissatele)	66
Pinze per ossa e costole	237,238	SCHMID, spatole vascolari	251
Pinze per polipi	163-169	SCHMIEDEN-TAYLOR, forbici	102
Pinze per polmoni	297	SCHNIDT-SAWTELL, pinze emostatiche per tonsille	55
		SELLORS, approssimatori costali	254
		SELLORS-CRAFOORD, pinze auricolari	57

	Pagina		Pagina
SEMB, cesoie per ossa	232	TROUTMAN-BARRAQUER, micro-portaghi con manici rotondi	156
SEMB, periostotomi costali	236	TUBBS, dilatatori	299
SEMB, pinze per bronchi	297	Tubi d'aspirazione e cannule	211-216
SEMB, pinze-sgorbie	225	TÜBINGEN MODELL, divaricatori	184
SEMKEN, pinze anatomiche e chirurgiche	77,78	TUDOR-EDWARDS, cesoie per ossa	231
SEMKEN, pinze tungsteno TUC	85	TUFFIER, divaricatori	185
SENN-GREEN, divaricatori sottili	173	TUFFIER, divaricatori costali	240
SENNING (SWEDISH PATTERN), portaghi tungsteno TUC	142	TUFFIER, pinze emostatiche	42
SENN-MILLER, divaricatori sottili	176		
SENN-MILLER-BABY, divaricatori sottili	176	U	
SIMON, divaricatori	184	UCKERMANN, portacotone	203
Sistema a braccio articolato con fissaggio rapido centrale	342,343	ULRICH, pinze per polipi	165
SMITH-PETERSON, pinze-sgorbie	228	UNIVERSAL, forbici tungsteno TUC	128
SMITH-POTTS, forbici	104		
SMITH-POTTS, forbici per chirurgia vascolari	99,101	V	
SMITH-POTTS, micro-portaghi tungsteno TUC	153	VERNET-GIL, divaricatori sottili	175
SMITH-POTTS, pinze anatomiche e chirurgiche	81	VOLKMANN, divaricatori	177,178
SMITH-POTTS, pinze tungsteno TUC	85		
SNITMAN, divaricatori autostatici	194	W	
Sonde	201,202	WALTON, forbici fini	106
Sonde e strumenti vascolari	199-209	WALTON-LISTON, cesoie per ossa	230
Sorgente luce fredda	332-338	WALTON-YANKAUER, cannule per aspirazione	213
Spatole	251	WANGENSTEEN, pinze tungsteno TUC	87
Spatole per polmone	255	WANGENSTEEN, portaghi tungsteno TUC	145
Spatole vascolari	251	WEBER, pinze atrauma	277
SPENCER-WELLS, pinze emostatiche	44	WEBSTER, portaghi tungsteno TUC	143
STACKE, sonde	201	WEITLANER, divaricatori autostatici	195
STANDARD, forbici tungsteno TUC	118,119	WEITLANER-BABY, divaricatori autostatici	195
STANDARD, pinze anatomiche per dissezione	75	WELLS-SPENCER, pinze emostatiche	44
STANDARD, pinze chirurgiche a denti di topo	75	WERTHEIM, portaghi tungsteno TUC	146
STERNUM, portaghi tungsteno TUC	151	WIKSTROEM, pinze per preparazioni e legatura	65
STEVENS, forbici per tenotomia	109		
STEVENS, forbici tungsteno TUC	127	Y	
STILLE, pinze-sgorbie	225	YANKAUER, cannule per aspirazione	213
STILLE-LISTON, cesoie per ossa	231	YANKAUER-WALTON, cannule per aspirazione	213
STILLE-LUER, pinze-sgorbie	226		
STILLE-RUSKIN, pinze-sgorbie	225	Z	
STRATTE, portaghi tungsteno TUC	145	ZAUFAL-JANSEN, pinze-sgorbie	224
STRULLY, forbici	101	ZENKER, divaricatori	190
Strumenti per Laparoscopia / Torace	306-313	ZENKER, pinze per preparazioni e legature	60
Strumenti per ossa	217-232	ZWEIFEL, portaghi tungsteno TUC	150
Strumenti vascolari e sonde	199-209		
SUBRAMANIAN, pinze atrauma	296		
SUBRAMANIAN-MINIATURE, pinze atrauma	296		
SULLIVAN (BROPHY), forbici fine	105		
Super Cut forbici SC	91		
Sutura	135-161		
T			
TAYLOR, divaricatori spinali	176		
TAYLOR, pinze anatomiche e chirurgiche	78,79		
TAYLOR-CUSHING, pinze tungsteno TUC	86		
TAYLOR-SCHMIEDEN, forbici	102		
Tenaglie fili	222,223		
TERRIER, pinze emostatiche	44		
tini instruments (titan-nitride surface coating)	69,70		
Tiravene	206		
titan instruments	37,73,93,116,139		
TOENNIS, forbici	102		
TOENNIS, pinze per preparazioni e legature	64		
TOENNIS, portaghi tungsteno TUC	149		
TOENNIS-ADSON, forbici	102		
TOENNIS-ADSON-DELICATE, forbici tungsteno TUC	127		
TOHOKU-JAPAN, pinze per fissare le compresse (Fissatele)	67		
TÖNNIS, spatole vascolari	251		
Toroscopia	301-343		
Tornichetti	299		
TROUTMAN, micro-portaghi con manici rotondi	157		

nopa[®] instruments

nopa instruments

Medizintechnik GmbH
Weilatten 7-9
D - 78532 Tuttlingen

Tel. +49.7462.9490-0
Fax +49.7462.9490-90
info@nopa.de
www.nopa.de

Herstellung und Verkauf chirurgischer
und endoskopischer Instrumente.
Manufacture and Sales of Surgical
and Endoscopic Instruments.

