gynäkologie, geburtshilfe, urologie
gynecology, obstetrics, urology
ginecología, obstetricia, urología
gynécologie, obstétrique, urologie
ginecologia, ostetrica, urologia

nopa[®] instruments





Dies ist unser Katalog, er bleibt unser ausschließliches Eigentum. Es gelten unsere allgemeinen Lieferbedingungen. Sie finden diese auf unserer Internetseite: www.nopa-instruments.com.

This is our Catalogue. It remains our exclusive property. Please find our "General Terms of Sale" on our corporate website: www.nopa-instruments.com.

Esto es nuestro catálogo queda nuestra propiedad. Nuestras condiciones generales de venta se encuentran en nuestra página web: www.nopa-instruments.com.

Voilà notre catalogue et il demeure notre propriété. Veuillez consulter nos conditions générales de vente sur notre page Internet: www.nopa-instruments.com.

Questo è nostro catalogo e rimane nostra proprietà. Trovano applicazione le nostre condizioni generali di fornitura, che sono disponibili sul nostro sito: www.nopa-instruments.com.

Modelländerungen vorbehalten. Nachdruck, auch auszugsweise, verboten.
Change of design and pattern reserved. Re-printing, even in extracts, not permitted.
Nos reservamos el derecho de modificaciones sin aviso previo. Reimpresión, también parcialmente, está prohibido.
Tous droits réservés aux changements de modèle. Réimprimer, également partiellement, est interdit.
Noi riserviamo il diritto di effettuare delle modificazioni. Ristampa di divieto anche parziale.



confidence in

nopa[®] instruments

more than

30
YEARS

thank you for choosing

nopa[®] instruments

...you obviously have good taste

CATALOGUES

Bitte fordern Sie unsere
entsprechenden Kataloge an.

Please request for our
appropriate catalogues.

Por favor pidan por nuestros
catálogos apropiados.

Veillez demander nos
catalogues appropriés.

Chieda prego i nostri
cataloghi adatti.

>> Unser Lieferprogramm

Allgemeinchirurgie
Gynäkologie, Geburtshilfe und Urologie
Plastische Chirurgie und HNO
Thorax, Herz und Gefäßchirurgie
Neurochirurgie
Ophthalmologie
Endoskopie
Container und Sterilisation
Dental und Oral

>> Our product range

General Surgery
Gynecology, obstetrics and urology
Plastic Surgery and ENT
Thoracic and cardiovascular surgery
Neurosurgery
Ophthalmology
Endoscopy
Container and Sterilization
Dental and Oral

>> Nuestra gama de productos

Cirugía general
Ginecología, obstetricia y urología
Cirugía plástica y ORL
Cirugía torácica y cardiovascular
Neurocirugía
Oftalmología
Endoscopia
Contenedor y esterilización
Odontología y oral

>> Notre gamme

Chirurgie générale
Gynécologie, obstétrique et urologie
Chirurgie plastique et ORL
Chirurgie thoracique et cardiovasculaire
Neurochirurgie
Ophtalmologie
Endoscopie
Conteneur et stérilisation
Dental et Oral

>> Nostro programma di produzione

Chirurgia generale
Ginecologia, ostetricia e urologia
Chirurgia plastica ed ORL
Chirurgia toracica e cardiovascolare
Neurochirurgia
Oftalmologia
Endoscopia
Contentitore e sterilizzazione
Odontoiatria e Orale

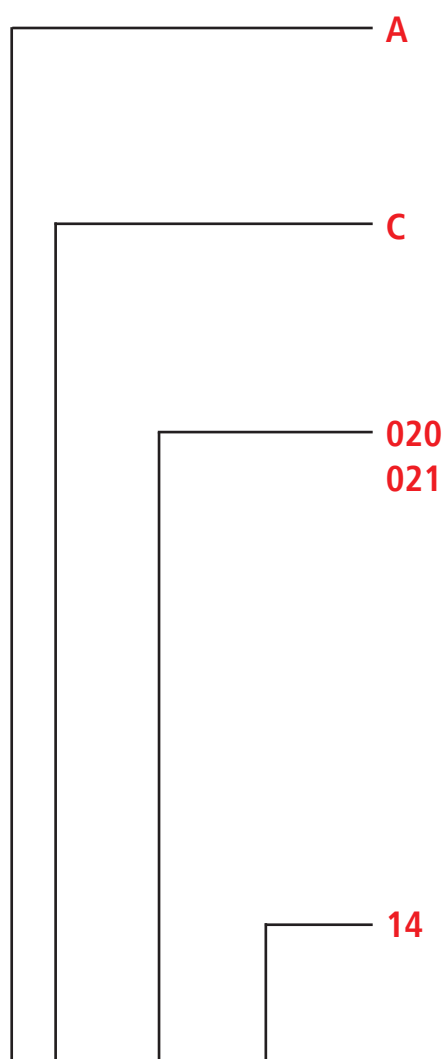

Artikelcode **AC 020/14**

Allgemeines Instrumentarium

General Instruments
Instrumental Général
Instruments Générales
Strumenti generali

Scheren

Scissors
Tijeras
Ciseaux
Forbici

Fortlaufende Nummern

Gerade Ziffer = gerades Instrument
Ungerade Ziffer = gebogenes Instrument

Continuous number

Even number = straight instrument
Odd number = curved instrument

Número de orden

números pares = instrumento derecho
números impares = instrumento curvado

Numéros d'ordre

numéro pair = instrument droit
numéro impair = instrument courbe

Numeri progressivamente

numero pari = strumento retto
numero dispari = strumento curvo

Länge oder Figur

Length or Figure
Longitud o figura
Longueur ou figure
Lunghezza o figura

GYN

Gynecology Sets

ZS 140/00	>> Abdominal Set		9-16
ZS 140/05	>> Vaginal - Hysterectomy		17-24
ZS 140/10	>> Mammoplasty Set		25-30
ZS 140/25	>> Hysteroscopy Endometrial Diagnostic Set		31-36
ZS 140/30	>> Conisation Set		37-42
ZS 140/35	>> Caesarean Section Set		43-48
ZS 140/40	>> Partus Set		49-52
ZS 140/45	>> Delivery Set		53-56
ZS 140/55	>> Dilatation/Curettage Set		57-62
ZS 981/04	>> Hysteroscopy Basic Set	Endoscopy	63-68

URO

Urology Sets

ZS 145/05	>> Nephrectomy Set		69-74
ZS 981/01	>> Resectoscopy Basic Set	Endoscopy	75-78
ZS 981/02	>> Cystoscopy Basic Set	Endoscopy	79-82

For more recommended sets kindly refer to our website

www.nopainstruments.de/produkte



INDEX INSTRUMENTS

>> Klemmen • Hemostats • Pinzas hemostáticas Pinces hémostatiques • Pinze emostatiche	105-136	AA
>> Pinzetten • Forceps • Pinzas • Pinces • Pinze	137-158	AB
>> Scheren • Scissors • Tijeras • Ciseaux • Forbici	159-198	AC
>> Skalpelle • Scalpels • Bisturíes • Bistouris • Bisturi	199-208	AD
>> Naht • Suture • Sutura • Suture • Sutura	209-232	AE
>> Tupferzangen • Sponge Forceps >> Pinzas para pólipos • Pinces à pansements • Pinze per polipi	237-244	AF
>> Wundhaken • Retractors • Separadores • Ecarteurs • Divaricatori	245-288	AK
>> Sonden • Probes • Sondas • Sondes • Sonde	289-296	AL
>> Punktion/Kanülen • Puncture/Special Needles • Punción/Agujas especiales Ponction/Aiguilles spéciales • Puntura/Aghi speciali	297-306	AO
>> Narkose • Anaesthesia • Anestesia • Anesthésie • Anestesia	307-320	AP
>> Diagnostik • Diagnostics • Diagnóstico • Diagnostic • Diagnostica	321-330	AR
>> Gynäkologie/Geburtshilfe • Gynecology/Obstetrics • Ginecología/Obstetricia Gynécologie/Obstétrique • Ginecologia/Ostetricia	331-388	KB
>> Mammoplastik • Mammoplasty • Mammoplastia Plastie Mammaire • Plastica Mammaria	389-398	KI
>> Urologie • Urology • Urología • Urologie • Urologia	399-418	KC
>> Verschiedenes • Various Items • Diversos Articulos Articles divers • Articoli diversi	419-426	KU
>> Container System • Container System • Sistema de contenedor Système de conteneur • Sistema del contenitore	427-448	KYE
>> Endoskopie • Endoscopy • Endoscopia • Endoscopie • Endoscopia	451-532	X



ABDOMINAL

GYN

SET

ZS 140/00

Siebvorschlag - Suggested instrument set



ZS 140/00 GYNECOLOGY ABDOMINAL SET

Contents:		Qty
AA 200/24	ROCHESTER-PEAN ARTERY FCPS STR 24,0 CM	2
AA 210/24	OCHSNER-KOCHER ART.FCPS.STR 24,0 CM	4
AA 216/14	KOCHER-DELICATE ART.FCPS.STR 1X2T 14,0 CM	10
AA 223/01	OVERHOLT-GEISSENDOERFER FIG.1 27,0 CM	2
AA 335/03	RUMEL FORCEPS FIG.3, 23,0 CM	2
AA 543/01	PARAMETRIUM-CLAMP FIG.1,CVD 24,0 CM	1
AA 543/02	PARAMETRIUM-CLAMP FIG.2,CVD 24,0 CM	1
AA 558/25	NON-TRAUMATIC HAEMORRHOIDAL FORCEPS 25,0 CM	1
AB 060/20	STANDARD TISSUE FCPS. 1X2 T STR 20,0 CM	2
AB 060/25	STANDARD TISSUE FCPS. 1X2 T STR 25,0 CM	2
AB 430/15	GILLIES TISSUE FCPS 1X2 TEETH 15,0 CM	1
AB 862/20	DE BAKEY ATRAUMA FCPS STR 2,0 MM 20,0 CM	2
AB 862/24	DE BAKEY ATRAUMA FCPS STR 2,0 MM 24,0 CM	2
AC 011/15	STANDARD OPER.SCS. CVD.BL/BL 15,5 CM	1
AC 091/20	SIMS SCISSORS CVD BL/BL 20,0 CM	1
AC 919/23	SIMS GYN SCISSORS TUC CVD 23,0 CM	1
AC 941/20	METZENBAUM SCS TUC CVD BL/BL 20,0 CM	1
AC 971/25	METZENBAUM-DELICATE SCS TUC CVD BL/BL 25,0 CM	1
AD 010/04	SCALPEL HANDLE NO.4	2
AE 400/16	MAYO-HEGAR NEEDLE HOLDER TUC 16,0 CM	1
AE 400/20	MAYO-HEGAR NEEDLE HOLDER TUC 20,0 CM	1
AE 400/24	MAYO-HEGAR NEEDLE HOLDER TUC 24,0 CM	1
AE 476/24	BOZEMANN NEEDLE HOLDER TUC S-CVD 24,0 CM	2
AF 100/27	GROSS-MAIER DRESSING FCPS STR 27,0 CM	5
AF 101/27	GROSS-MAIER DRESSING FCPS CURVED 27,0 CM	1
AF 200/25	FOERSTER-BALLENGER STR SERRATED 25,0 CM	2
AF 201/25	FOERSTER-BALLENGER CVD SERRATED 25,0 CM	1
AK 254/75	FRITSCH RETRACTOR 45X75 MM 24,0 CM	2
AK 350/01	ROUX RETRACTOR FIG.1	2
AK 350/03	ROUX RETRACTOR FIG.3	2
AK 804/40	ABDOMINAL SPATULA 33,0 CM	1
AO 820/14	GUIDE NEEDLE 14 CHARR.	1
KB 093/30	BREISKY VAG.SPEC.BAYONET SH.130X30 MM	1
KB 255/25	SCHROEDER FORCEPS BOX LOCK, 25,0 CM	2
KB 262/24	SCHROEDER VULSELLUM FCPS STR 2X2T 24,0 CM	1
KB 265/28	PRATT VULSELLUM FORCEPS 4X4 T. 28,0 CM	1
KK 486/27	DE BAKEY ATRAUMA-KLEMMME 27,0 CM	2
KU 300/08	MIXING BOWL 80 x 40 MM	2
KU 302/25	KIDNEY TRAY 250 MM	2
KU 303/65	INNER BOX ONLY FOR NEEDLE CASE ROUND	1
XR 803/05	ELECTRODE HANDLE W. CABLE FOR MARTIN/BERCH	1
XR 841/01	UNIVERSAL-ELECTRODES	1
XR 843/04	UNIVERSAL-ELECTRODES	1
SK 307/05	WIRE BASKET, 540 X 255 X 50 MM	2

Sterilization Container KYE 200/71, if required

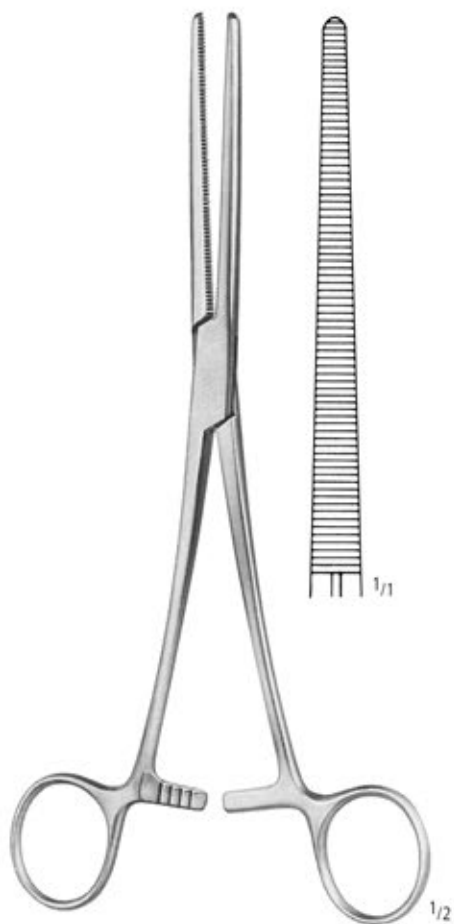

ROCHESTER-PEAN
AA 200/24
24,0 cm/9½"



OCHSNER-KOCHER 1:2
AA 210/24
24,0 cm/9½"



KOCHER 1:2 - DELICATE
AA 216/14
14,0 cm/5½"

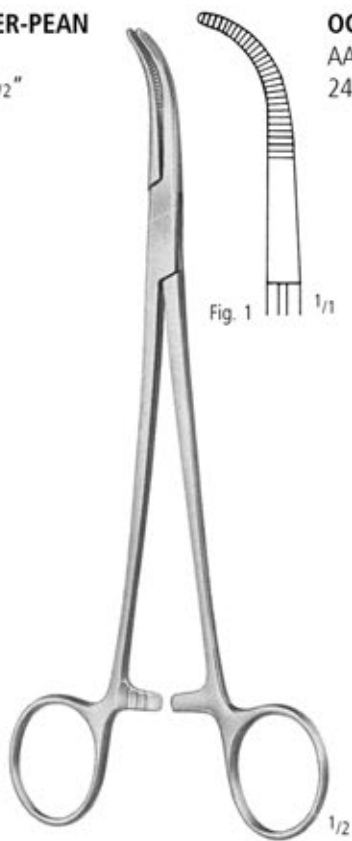

OVERHOLT-GEISSENDOERFER
AA 223/01
27,0 cm/10¾"

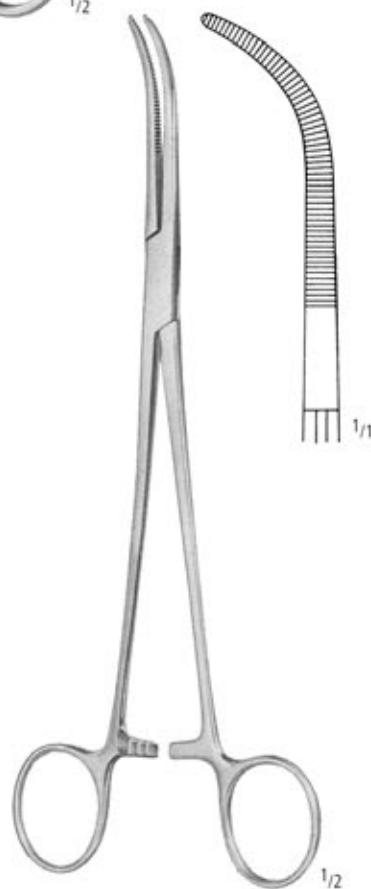

RUMEL
AA 335/03
23,0 cm/9"

ZS 140/00 GYNECOLOGY ABDOMINAL SET

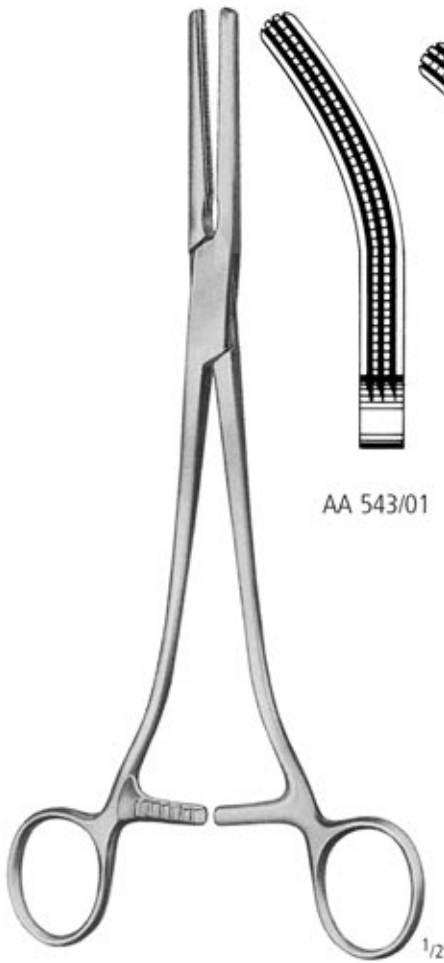

PARAMETRIUM
24,0 cm/9 1/2"

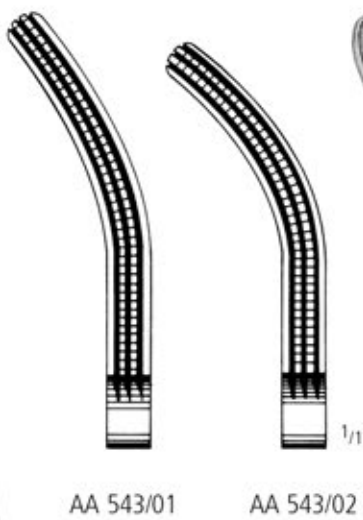

AA 543/01

AA 543/02

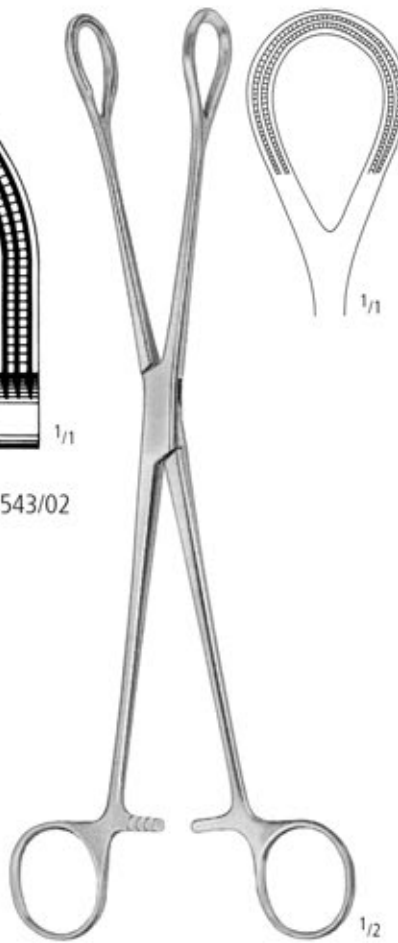

AA 558/25
25,0 cm/10"

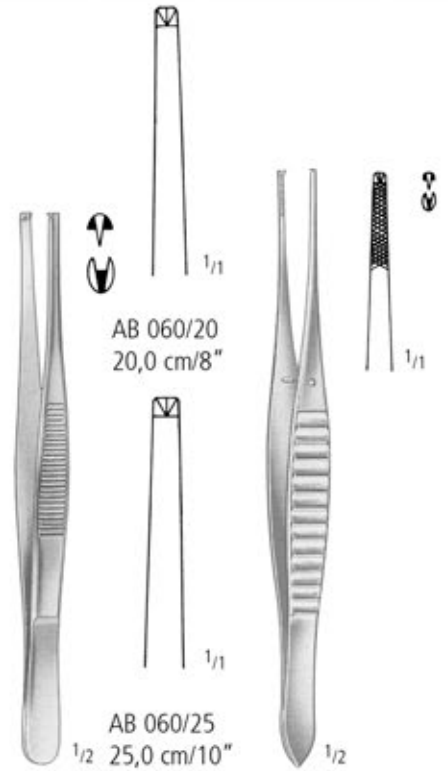

AB 060/20
20,0 cm/8"



AB 060/25
25,0 cm/10"

**1:2
STANDARD**

GILLIES 1:2
AB 430/15
15,0 cm/6"



DE BAKEY

2,0 mm
AB 862/20
20,0 cm/8"

2,0 mm
AB 862/24
24,0 cm/9 1/2"

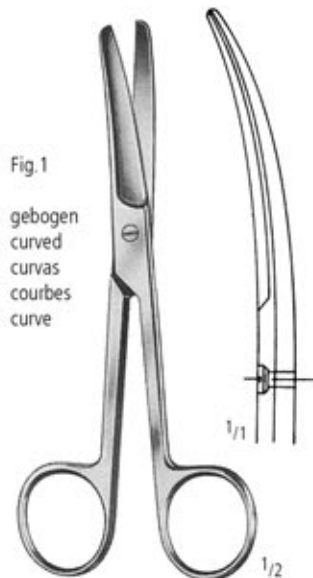

STANDARD
AC 011/15
15,5 cm/6"

Fig. 1
gebogen
curved
curvas
courbes
curve



AC 091/20
20,0 cm/8"

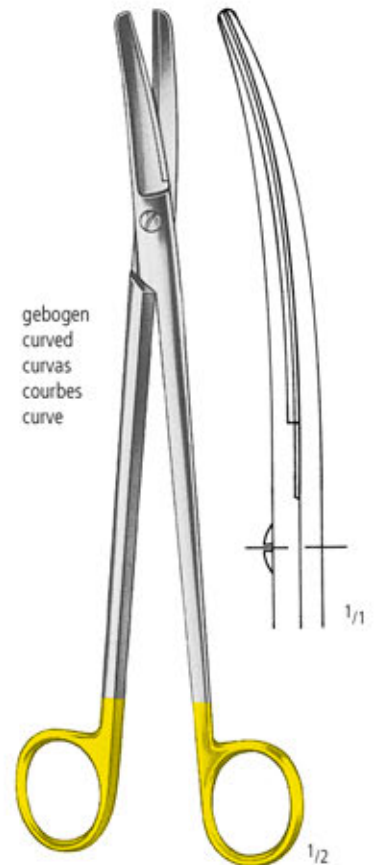

SIMS
AC 919/23
23,0 cm/9"

gebogen
curved
curvas
courbes
curve

ZS 140/00 GYNECOLOGY ABDOMINAL SET

gebogen
curved
curvas
courbes
curve

gebogen
curved
curvas
courbes
curve

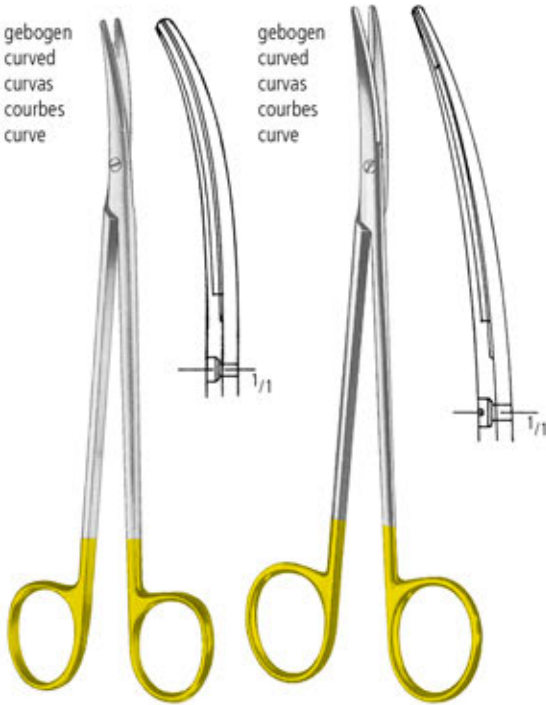

METZENBAUM
AC 941/20
20,0 cm/8"

METZENBAUM-DELICATE
AC 971/25
25,0 cm/10"

AD 010/04
No. 4



1/2

MAYO-HEGAR

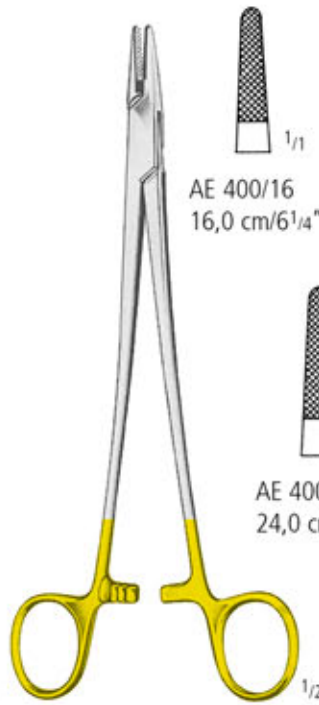

AE 400/16
16,0 cm/6 1/4"

AE 400/20
20,0 cm/8"

AE 400/24
24,0 cm/9 1/2"

1/2

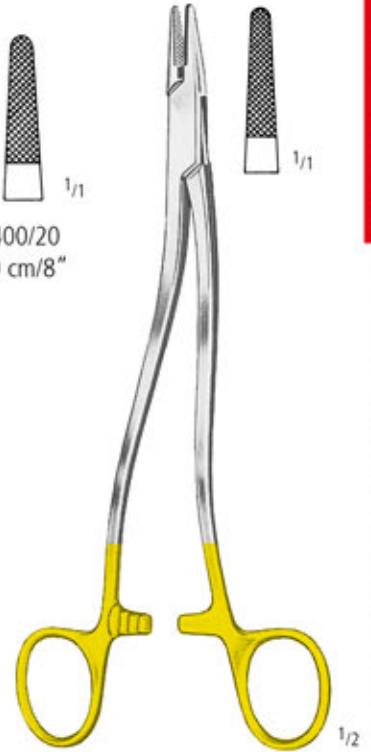

BOZEMANN
AE 476/24
24,0 cm/9 1/2"

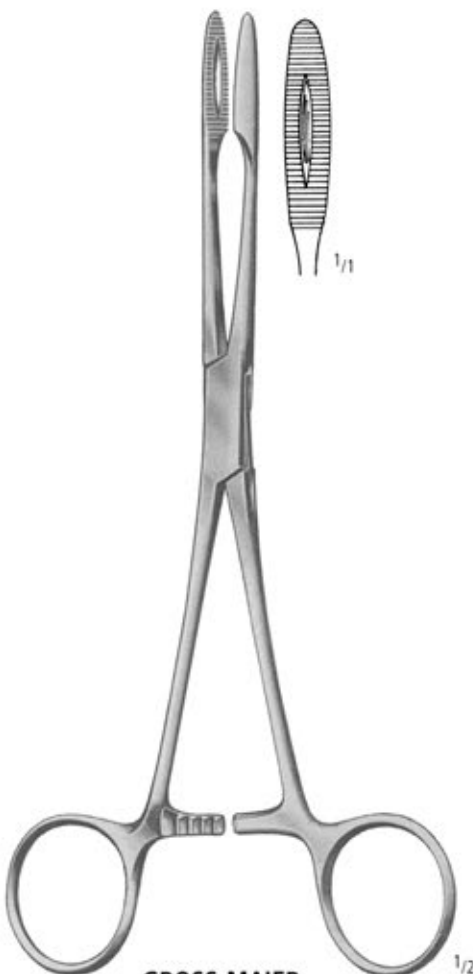

GROSS-MAIER
AF 100/27
27,0 cm/10 3/4"

1/2

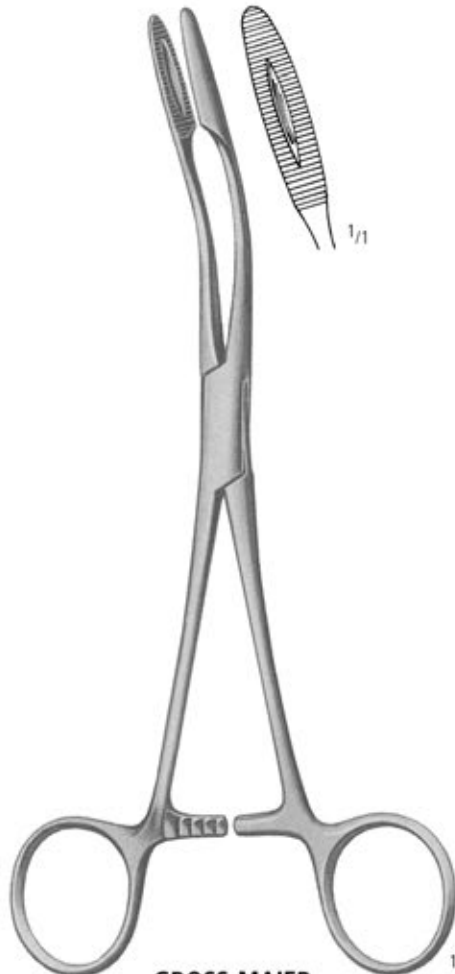

GROSS-MAIER
AF 101/27
27,0 cm/10 3/4"

1/2

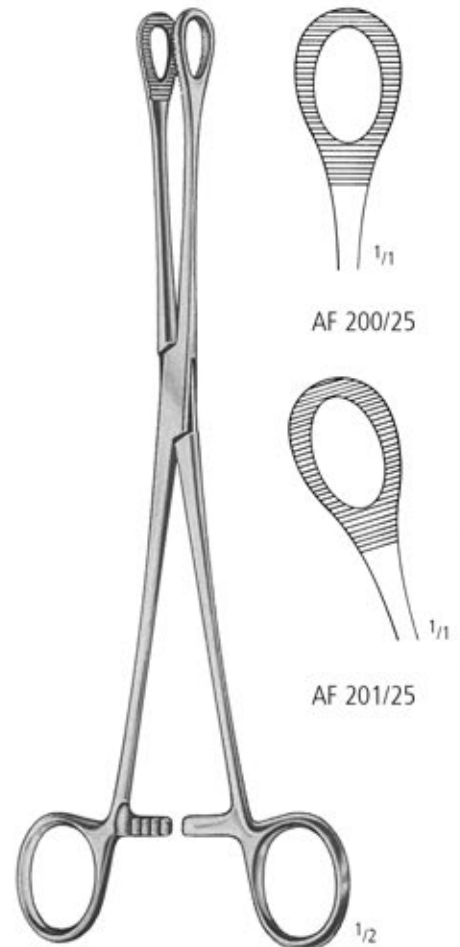

FOERSTER-BALLENGER
25,0 cm/10"

1/2

GYN

ZS 140/00

ZS 140/05

ZS 140/10

ZS 140/15

ZS 140/20

ZS 140/25

ZS 140/30

ZS 140/35

ZS 140/40

ZS 140/45

ZS 140/50

ZS 140/55

ZS 140/60

ZS 140/65

ZS 140/70

URO

ZS 981/04

ZS 981/05

ZS 981/06

ZS 981/07



FRITSCH
24,0 cm / 9¹/₂"
45 x 75 mm AK 254/75



ROUX
16,5 cm / 6¹/₂"
Fig. 1 AK 350/01
Fig. 3 AK 350/03



biegsam
malleable
maleables
malléables
malleabili



Charr./Fr.
14 AO 820/14



BREISKY
130 x 30 mm
KB 093/30



SCHRÖDER
KB 255/25
25,0 cm / 10"

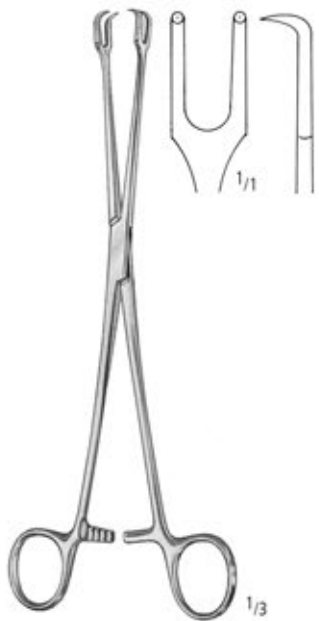

SCHRÖDER
KB 262/24
24,0 cm / 9¹/₂"

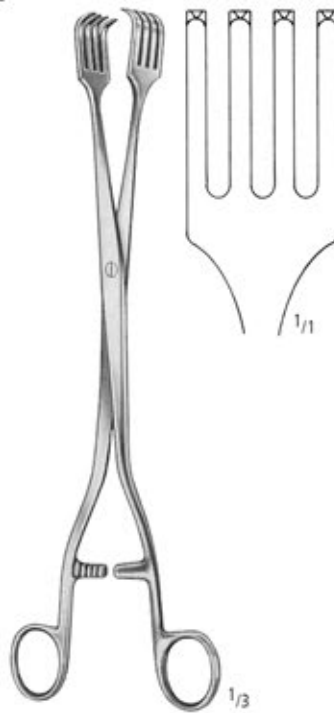

PRATT
KB 265/28
28,0 cm / 11"

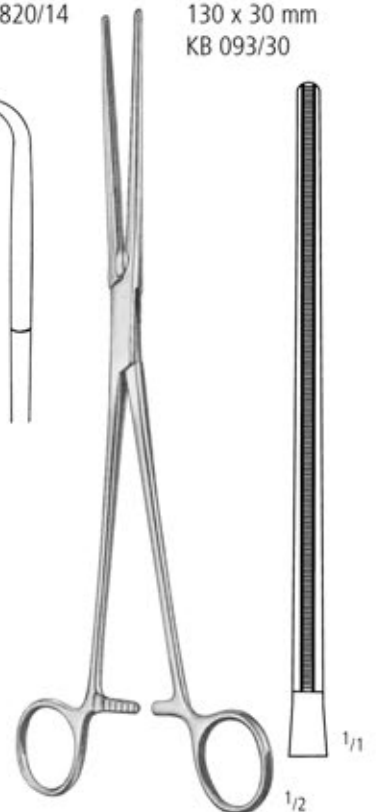

DE BAKHEY
KK 486/27
27,0 cm / 10¹/₂"



Ø x h
80 x 40 mm 0,14 l KU 300/08

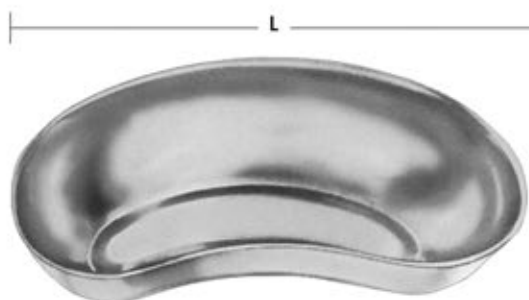

L = 250 mm KU 302/25

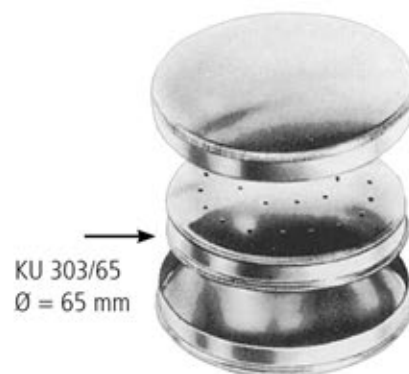

KU 303/65
Ø = 65 mm



MARTIN/BERCHTOLD
XR 803/05



XR 841/01



XR 843/04

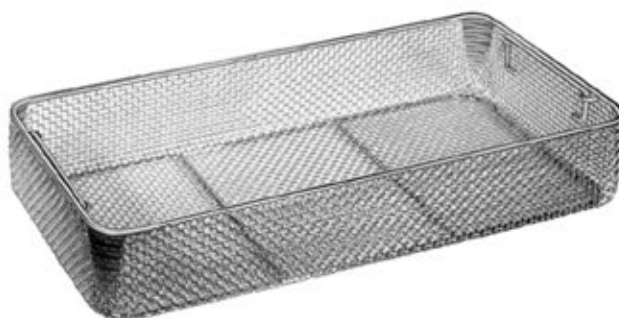

L(mm)	B(mm)	H(mm)	
540	255	50	SK 307/05



VAGINAL - HYSTERECTOMY

GYN

SET

ZS 140/05

Siebvorschlag - Suggested instrument set



ZS 140/05 VAGINAL-HYSTERECTOMY SET

Contents:		Qty
AA 200/24	ROCHESTER-PEAN ARTERY FCPS STR 24,0 CM	2
AA 210/24	OCHSNER-KOCHER ART.FCPS.STR 24,0 CM	2
AA 211/16	OCHSNER-KOCHER ART.FCPS.CVD 16,0 CM	2
AA 216/14	KOCHER-DELICATE ART.FCPS.STR 1X2T 14,0 CM	6
AA 221/02	OVERHOLT-GEISSENDOERFER FIG.2 21,0 CM	1
AA 223/01	OVERHOLT-GEISSENDOERFER FIG.1 27,0 CM	2
AA 335/04	RUMEL DISS.FORCEPS FIG.4, 23,0 CM	1
AA 543/01	PARAMETRIUM-CLAMP FIG.1,CVD 24,0 CM	1
AA 543/02	PARAMETRIUM-CLAMP FIG.2,CVD 24,0 CM	1
AB 050/20	STANDARD DRESSING FORCEPS STR 20,0 CM	2
AB 060/20	STANDARD TISSUE FCPS. 1X2 T STR 20,0 CM	3
AB 060/25	STANDARD TISSUE FCPS. 1X2 T STR 25,0 CM	1
AC 011/15	STANDARD OPER.SCS. CVD.BL/BL 15,5 CM	1
AC 091/20	SIMS GYNEC. SCISSORS CVD BL/BL 20,0 CM	1
AC 091/23	SIMS GYNEC. SCISSORS CVD BL/BL 23,0 CM	1
AC 941/18	METZENBAUM SCS TUC CVD BL/BL 18,0 CM	1
AC 941/23	METZENBAUM SCS TUC CVD BL/BL 23,0 CM	1
AD 010/04	SCALPEL HANDLE NO.4	2
AE 400/20	MAYO-HEGAR NEEDLE HOLDER TUC 20,0 CM	2
AE 487/24	WERTHEIM NEEDLE HOLDER TUC S-CVD 24,0 CM	2
AF 100/27	GROSS-MAIER DRESSING FCPS STR 27,0 CM	4
AF 201/25	FOERSTER-BALLENGER CVD SERRATED 25,0 CM	1
AK 239/28	MODELL TÜBINGEN RETRACTOR 95X20 MM 28,0 CM	1
KB 062/02	KRISTELLER VAG.SPECULA 110X30MM, FIG.2	1
KB 078/05	SCHERBAK VAGINAL SPECULA,SET COMPLETE	1
KB 093/25	BREISKY VAG.SPEC.BAYONET SH.130X25 MM	1
KB 093/30	BREISKY VAG.SPEC.BAYONET SH.130X30 MM	2
KB 093/40	BREISKY VAG.SPEC.BAYONET SH.130X40 MM	1
KB 201/32	SIMS UTERINE SOUND MALLEABLE"CM"32,0 CM	1
KB 255/25	SCHROEDER FORCEPS BOX LOCK, 25,0 CM	4
KD 055/15	ALLIS FCPS 5X6T 15,0 CM	8
KU 302/25	KIDNEY TRAY 250 MM	2
KU 303/65	INNER BOX ONLY FOR NEEDLE CASE ROUND	1
XR 803/05	ELECTR HANDLE W. CABLE FOR MARTIN/BERCH	1
XR 841/01	UNIVERSAL-ELECTRODES	1
XR 843/04	UNIVERSAL-ELECTRODES	1
SK 307/05	WIRE BASKET, 540 X 255 X 50 MM	1

Sterilization Container KYE 200/51, if required

ZS 140/05 VAGINAL-HYSTERECTOMY SET

GYN

ZS 140/00 ZS 140/05

ZS 140/10 ZS 140/25

ZS 140/30 ZS 140/35

ZS 140/40 ZS 140/45

ZS 140/55 ZS 981/04

ZS 140/55 ZS 981/04

ZS 145/05 ZS 981/01

ZS 981/02

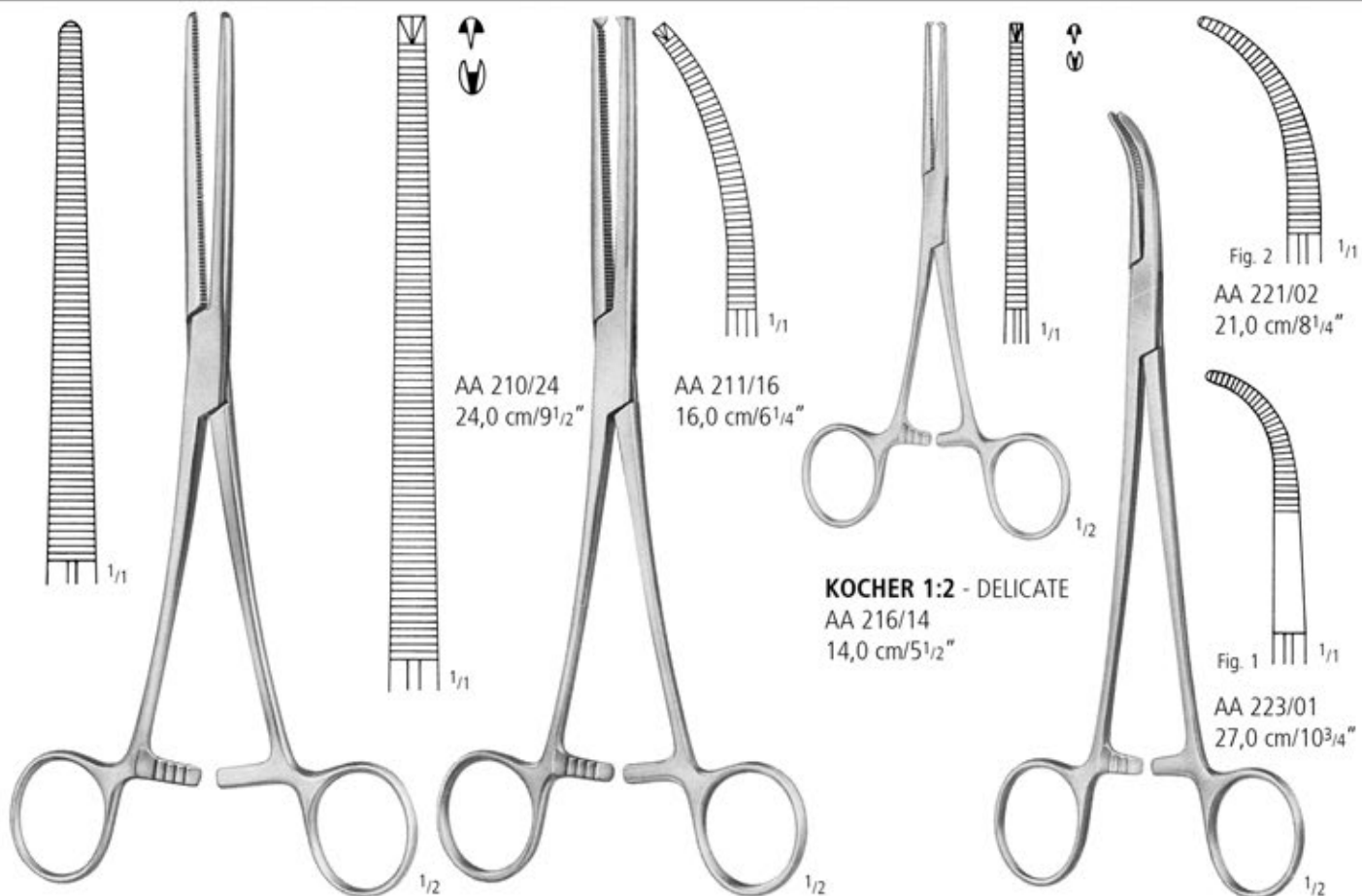

AA 210/24
24,0 cm/9 1/2"

AA 211/16
16,0 cm/6 1/4"

Fig. 2
AA 221/02
21,0 cm/8 1/4"

KOCHER 1:2 - DELICATE
AA 216/14
14,0 cm/5 1/2"

Fig. 1
AA 223/01
27,0 cm/10 3/4"

ROCHESTER-PEAN
AA 200/24
24,0 cm/9 1/2"

OCHSNER-KOCHER 1:2
24,0 cm/9 1/2"

OVERHOLT-GEISSENDOERFER
21,0 cm/8 1/4"

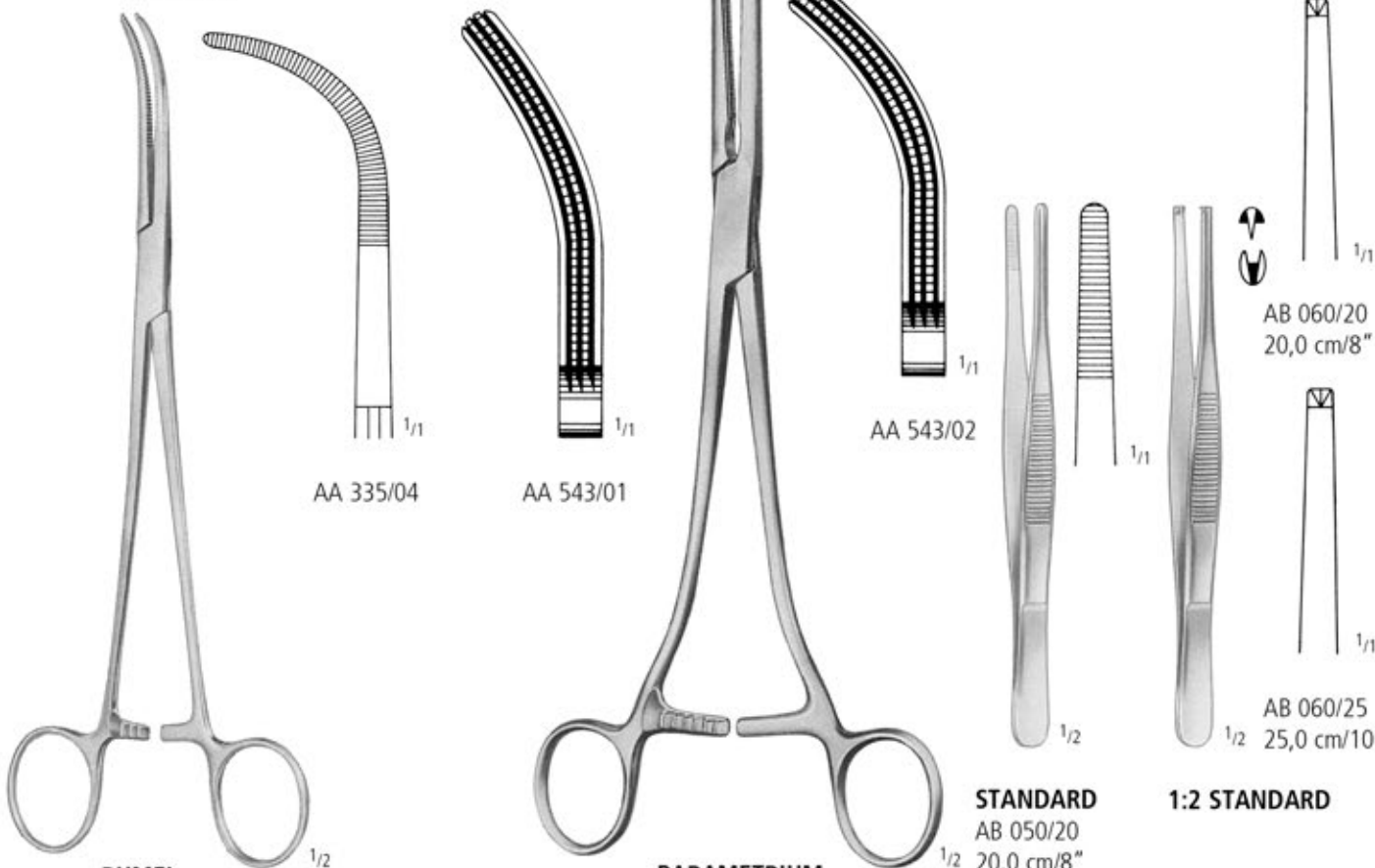

RUMEL
23,0 cm/9"

PARAMETRIUM
24,0 cm/9 1/2"

STANDARD
AB 050/20
20,0 cm/8"

1:2 STANDARD

AB 060/20
20,0 cm/8"

AB 060/25
25,0 cm/10"

URO



STANDARD

AC 011/15
15,5 cm/6"

SIMS

AC 091/20
20,0 cm/8"

AC 091/23
23,0 cm/9"

METZENBAUM

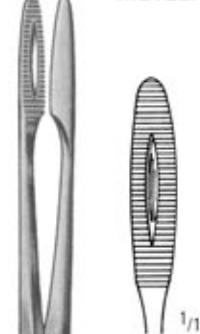

MAYO-HEGAR

AE 400/20
20,0 cm/8"



WERTHEIM

AE 487/24
24,0 cm/9 1/2"

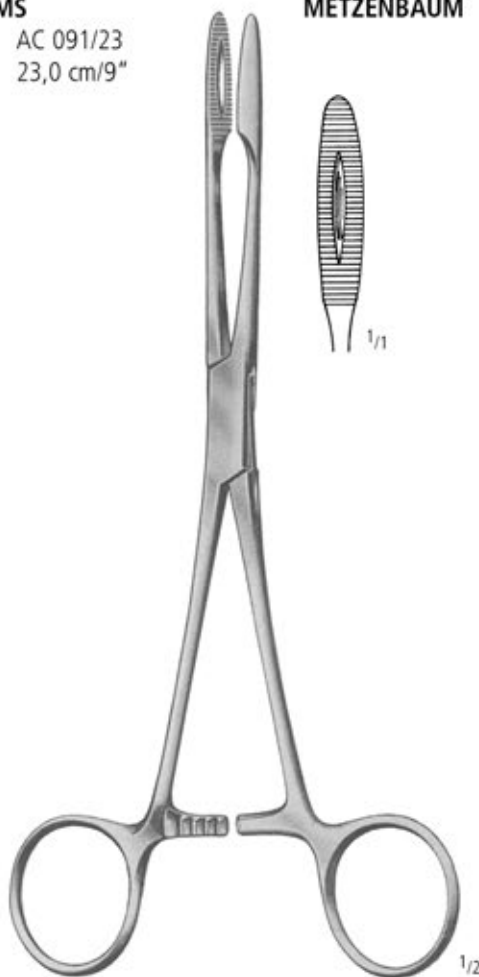

GROSS-MAIER

AF 100/27
27,0 cm/10 3/4"

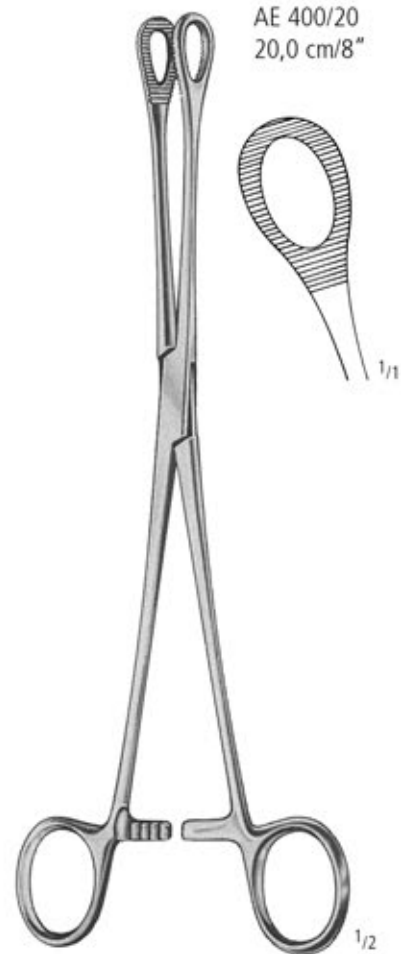

FOERSTER-BALLENGER

AF 201/25
25,0 cm/10"



MODELL TÜBINGEN
AK 239/28
28,0 cm/11"

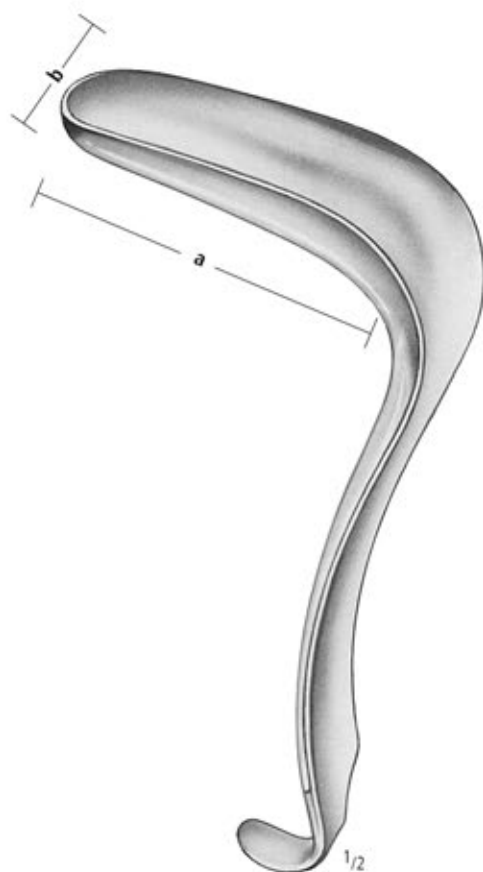

KRISTELLER
a b
Fig. 2 110 x 30 mm KB 062/02



SCHERBACK
400 g = KB 078/40

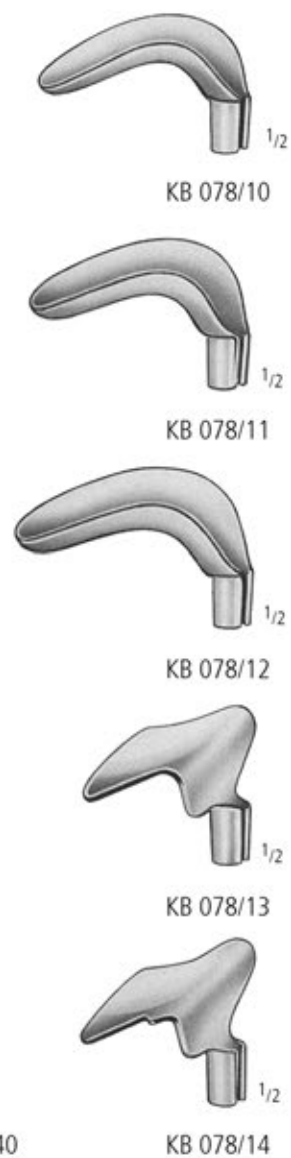

- KB 078/05 = KB 078/10
- KB 078/11
- KB 078/12
- KB 078/13
- KB 078/14
- KB 078/20
- KB 078/40



BREISKY

100 x 25 mm KB 093/25
 100 x 30 mm KB 093/30
 100 x 40 mm KB 093/40



biegsam
 malleable
 maleable
 malléable
 malleabile

SIMS

KB 201/32
 32,0 cm/12¹/₂"



SCHRÖDER
 KB 255/25
 25,0 cm/10"



BOYS-ALLIS 5:6
 KD 055/15
 15,0 cm/6"



L = 250 mm KU 302/25





MARTIN/BERCHTOLD
XR 803/05



XR 841/01



XR 843/04

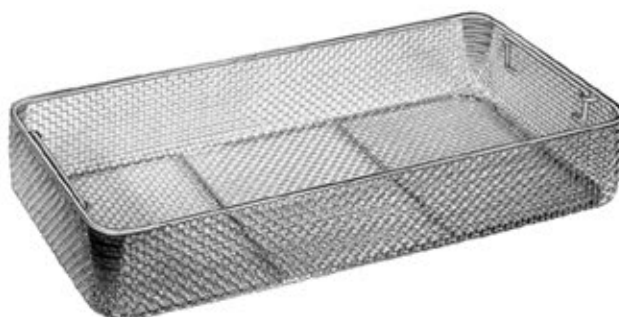

L(mm)	B(mm)	H(mm)	
540	255	50	SK 307/05

MAMMAPLASTY

GYN

SET ZS 140/10

Siebvorschlag - Suggested instrument set



ZS 140/10 MAMMAPLASTY SET

Contents:		Qty
AA 216/14	KOCHER-DELICATE ART.FCPS.STR 1X2T 14,0 CM	6
AA 221/02	OVERHOLT-GEISSENDOERFER FIG.2 21,0 CM	2
AA 348/18	BABY-MIXTER ART.FCPS CVD 18,0 CM	2
AB 060/14	STANDARD TISSUE FCPS. 1X2 T STR 14,5 CM	2
AB 060/20	STANDARD TISSUE FCPS. 1X2 T STR 20,0 CM	2
AB 080/16	TISSUE FORCEPS NARROW 1X2 TEETH 16,0 CM	1
AB 862/16	DE BAKEY ATRAUMA FCPS STR 2.0MM 16,0 CM	2
AB 862/20	DE BAKEY ATRAUMA FCPS STR 2.0MM 20,0 CM	2
AC 141/14	METZENBAUM-DELICATE BL/BL CVD 14,5 CM	1
AC 901/14	STANDARD SCS TUC CVD BL/BL 14,5 CM	1
AC 941/20	METZENBAUM SCS TUC CVD BL/BL 20,0 CM	1
AC 977/17	TOENNIS-ADSON SCS DELI TUC CVD 17,5 CM	1
AD 010/03	SCALPEL HANDLE NO.3	1
AD 010/04	SCALPEL HANDLE NO.4	1
AE 400/20	MAYO-HEGAR NEEDLE HOLDER TUC 20,0 CM	2
AE 470/15	CRILE-WOOD NEEDLE HOLDER TUC 15,0 CM	1
AF 070/27	ULRICH POLYPUS FORCEPS STRAIGHT 27,0 CM	1
AF 100/27	GROSS-MAIER DRESSING FCPS STR 27,0 CM	3
AK 050/03	RETRACTOR SHARP 3 PRONGS 16,0 CM	2
AK 100/14	CUSHING RECTRATOR 14,0 MM 20,0 CM	2
AK 350/00	ROUX RETRACTOR SET FIG.1-3	2
AK 350/03	ROUX RETRACTOR FIG.3	2
AO 821/10	GUIDE NEEDLE 10 CHARR.	1
AO 821/12	GUIDE NEEDLE 12 CHARR.	1
AO 821/14	GUIDE NEEDLE 14 CHARR.	1
KB 262/24	SCHROEDER VULSELLUM FCPS STR 2X2T 24,0 CM	1
KU 302/25	KIDNEY TRAY 250 MM	2
KU 303/65	INNER BOX ONLY FOR NEEDLE CASE ROUND	1
XR 830/03	CORDS,CONN.:MARTIN/BERCHTOLD,300 CM, BIPOL	1
XR 890/20C	BI-COAGULATION-FORCEPS,20,0 CM,1,0 MM	1
SK 305/07	WIRE BASKET, 485 X 255 X 50 MM	1

Sterilization Container KYE 200/51, if required

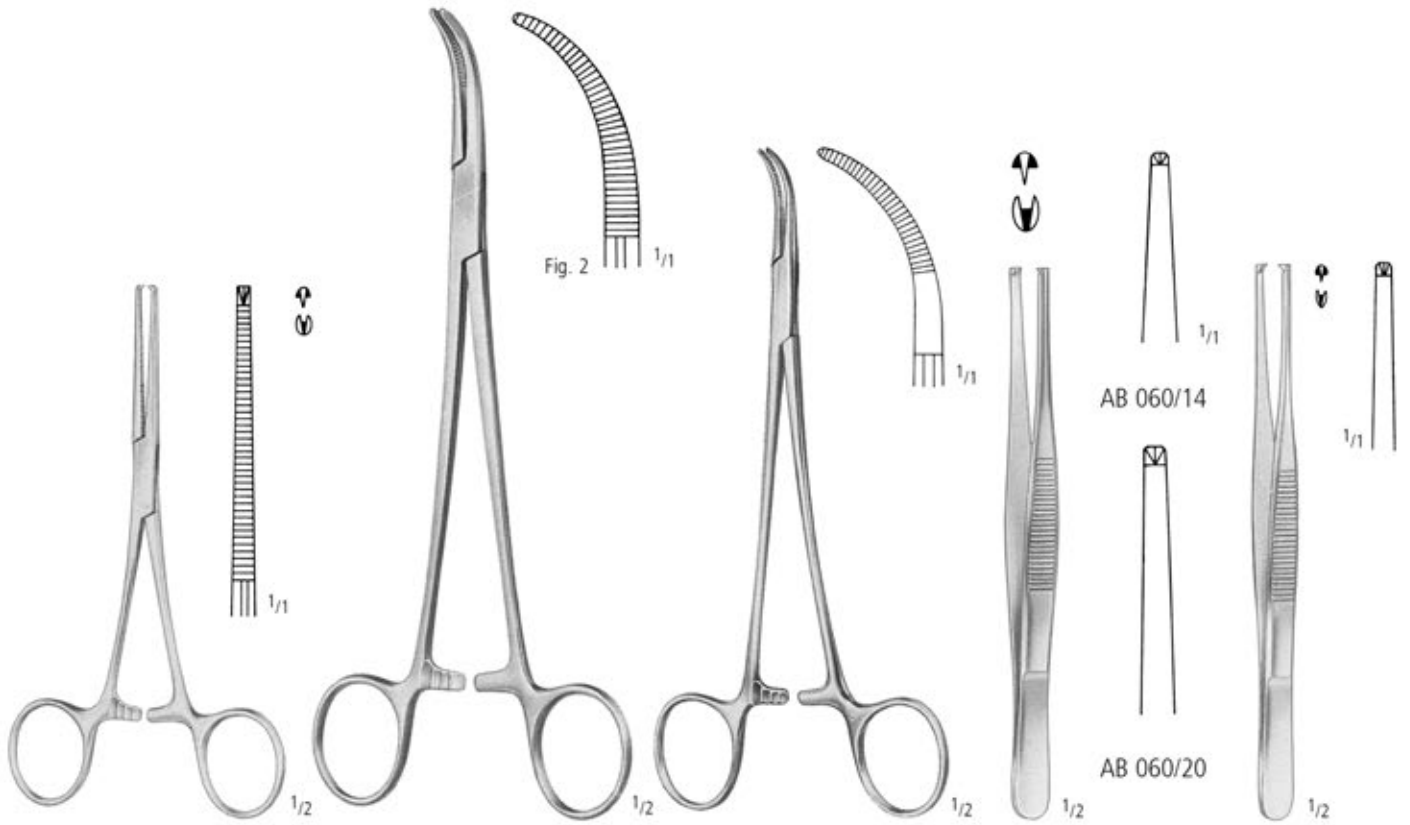

KOCHER 1:2 - DELICATE
AA 216/14
14,0 cm/5 1/2"

OVERHOLT-GEISSENDOERFER
AA 221/02
21,0 cm/8 1/4"

BABY-MIXTER
AA 348/18
18,0 cm/7"

STANDARD 1:2
20,0 cm/8"

1:2
AB 080/16
16,0 cm/6 1/4"



DE BAKY

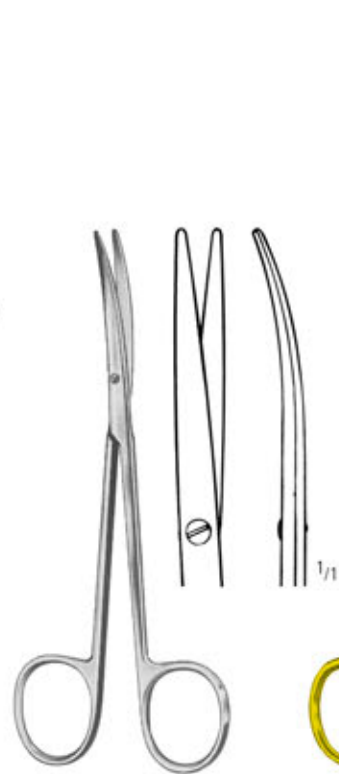

METZENBAUM-DELICATE
Fig. 1
AC 141/14
14,5 cm/5 3/4"

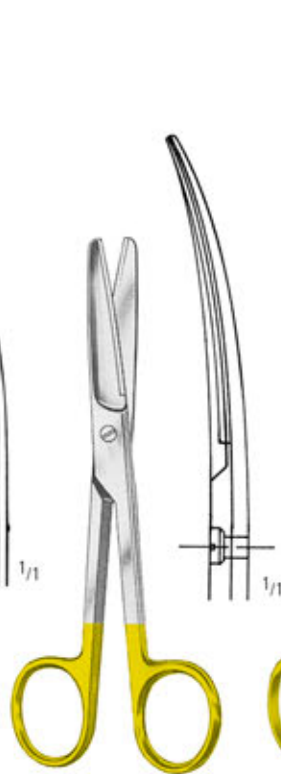

STANDARD
Fig. 1 curved:
AC 901/14
14,5 cm/5 3/4"

gebogen
curved
curvas
courbes
curve

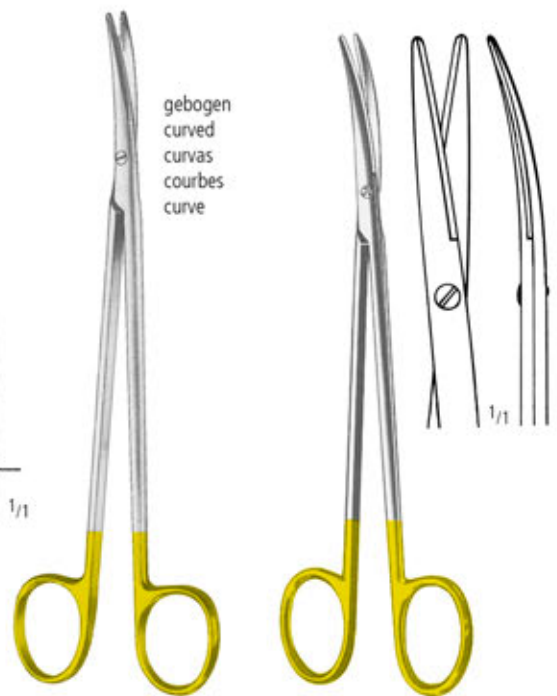

METZENBAUM
AC 941/20
20,0 cm/8"

TOENNIS-ADSON-DELICATE
AC 977/17
17,5 cm/7"



AD 010/03
No. 3



AD 010/04
No. 4



MAYO-HEGAR
AE 400/20
20,0 cm/8"



CRILE-WOOD
AE 470/15
15,0 cm/6"

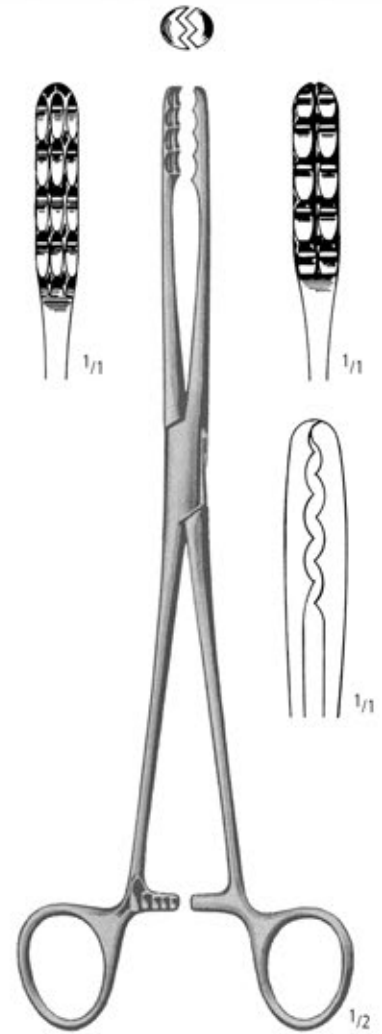

ULRICH
AF 070/27
27,0 cm/10³/₄"

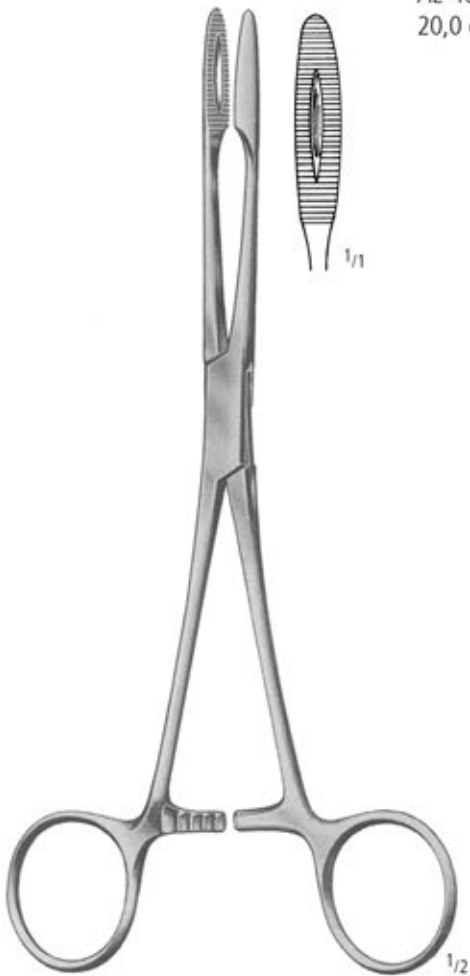

GROSS-MAIER
AF 100/27
27,0 cm/10³/₄"



AK 050/03
16,0 cm/6¹/₄"



CUSHING
AK 100/14
14 mm
20,0 cm/8"

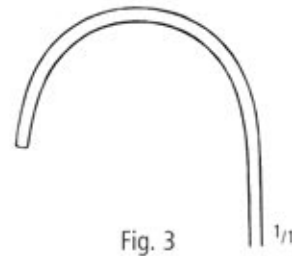
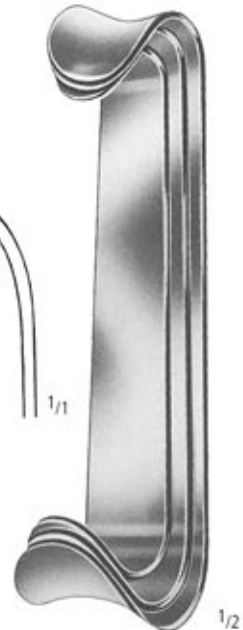

Fig. 3



ROUX
16,5 cm/6¹/₂"
Fig. 1+2+3 AK 350/00
Fig. 3 AK 350/03



Charr./Fr.

- 10 AO 821/10
- 12 AO 821/12
- 14 AO 821/14

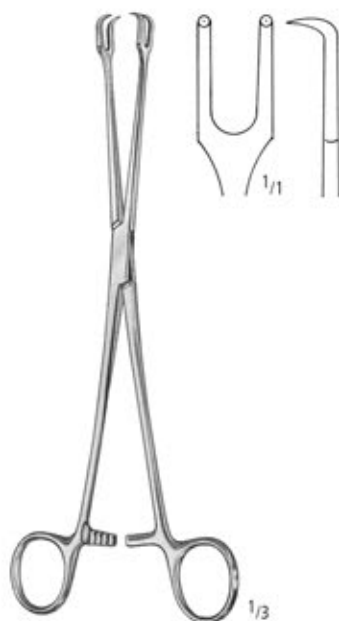

SCHRÖDER

KB 262/24
24,0 cm/9 1/2"



L = 250 mm KU 302/25

bipolar



MARTIN / BERCHTHOLD
300 cm XR 830/03

C=1,0 mm



XR 890/20C
20,0 cm/8"

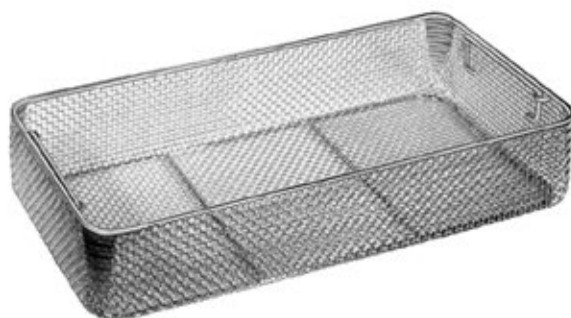

L(mm)	B(mm)	H(mm)	
485	255	70	SK 305/07

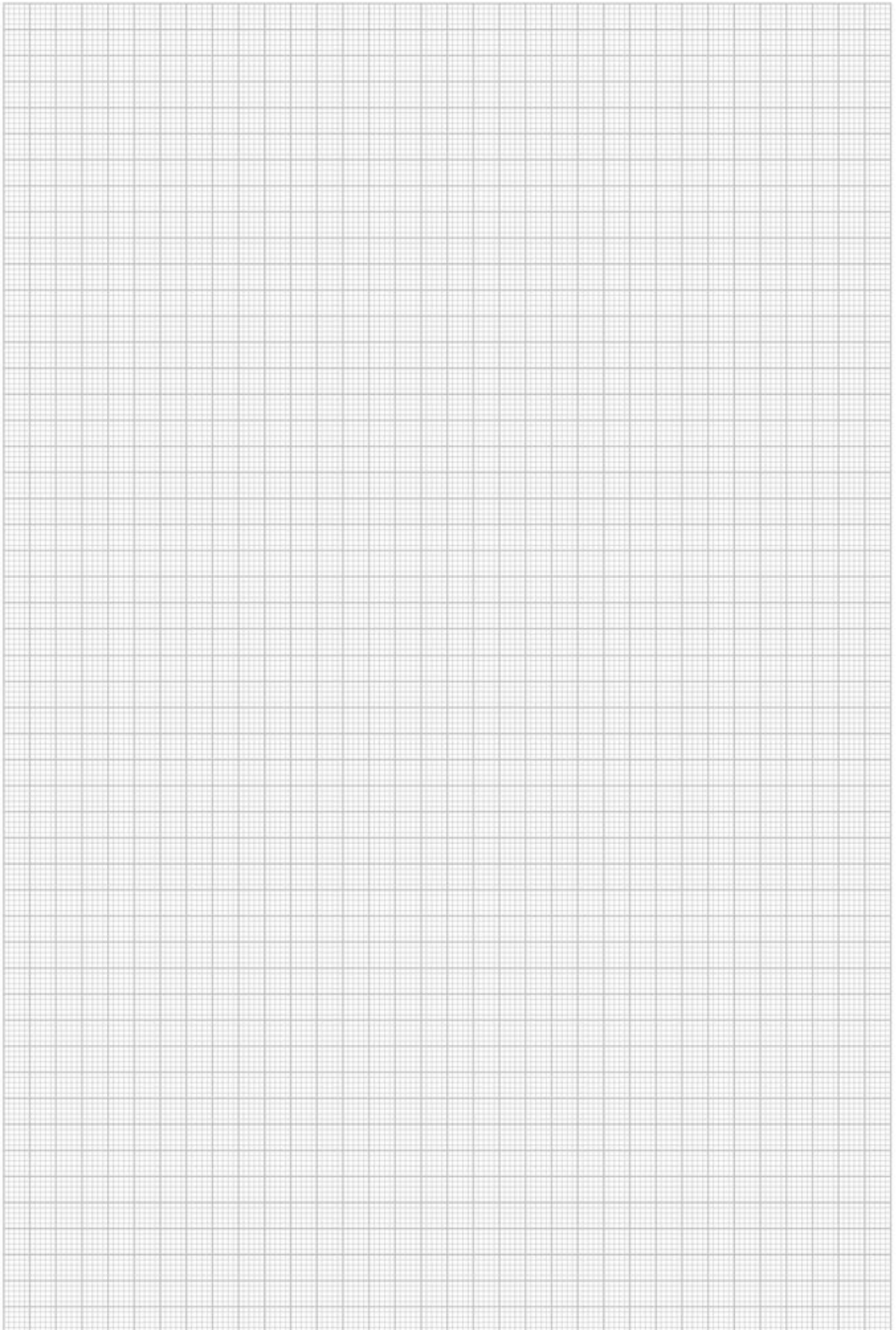

HYSTEROSCOPY
ENDOMETRIAL DIAGNOSTIC

GYN

SET

ZS 140/25

Siebvorschlag - Suggested instrument set



ZS 140/25 HYSTEROSCOPY ENDOMETRIAL DIAGNOSTIC SET

Contents:		Qty
AB 050/20	STANDARD DRESSING FCPS STR 20,0 CM	1
AF 100/27	GROSS-MAIER DRESSING FCPS STR 27,0 CM	1
AF 101/27	GROSS-MAIER DRESSING FCPS CURVED 27,0 CM	1
AO 912/00	CONNECTING PIECE	2
KB 064/02	KRISTELLER VAGINAL SPECULA SET FIG.2	1
KB 100/02	HEGAR UT.DILATOR W.SLOPED HDL 1,0 MM	1
KB 100/03	HEGAR UT.DILATOR W.SLOPED HDL 1,5 MM	1
KB 100/04	HEGAR UT.DILATOR W.SLOPED HDL 2,0 MM	1
KB 100/05	HEGAR UT.DILATOR W.SLOPED HDL 2,5 MM	1
KB 100/06	HEGAR UT.DILATOR W.SLOPED HDL 3,0 MM	1
KB 100/07	HEGAR UT.DILATOR W.SLOPED HDL 3,5 MM	1
KB 100/08	HEGAR UT.DILATOR W.SLOPED HDL 4,0 MM	1
KB 100/09	HEGAR UT.DILATOR W.SLOPED HDL 4,5 MM	1
KB 100/10	HEGAR UT.DILATOR W.SLOPED HDL 5,0 MM	1
KB 100/11	HEGAR UT.DILATOR W.SLOPED HDL 5,5 MM	1
KB 100/12	HEGAR UT.DILATOR W.SLOPED HDL 6,0 MM	1
KB 100/13	HEGAR UT.DILATOR W.SLOPED HDL 6,5 MM	1
KB 100/14	HEGAR UT.DILATOR W.SLOPED HDL 7,0 MM	1
KB 100/15	HEGAR UT.DILATOR W.SLOPED HDL 7,5 MM	1
KB 100/16	HEGAR UT.DILATOR W.SLOPED HDL 8,0 MM	1
KB 100/17	HEGAR UT.DILATOR W.SLOPED HDL 8,5 MM	1
KB 100/18	HEGAR UT.DILATOR W.SLOPED HDL 9,0 MM	1
KB 100/19	HEGAR UT.DILATOR W.SLOPED HDL 9,5 MM	1
KB 100/20	HEGAR UT.DILATOR W.SLOPED HDL 10,0 MM	1
KB 100/21	HEGAR UT.DILATOR W.SLOPED HDL 10,5 MM	1
KB 100/22	HEGAR UT.DILATOR W.SLOPED HDL 11,0 MM	1
KB 100/23	HEGAR UT.DILATOR W.SLOPED HDL 11,5 MM	1
KB 201/32	SIMS UTERINE SOUND MALLEABLE"CM"32,0 CM	1
KB 255/25	SCHROEDER FORCEPS BOX LOCK 25,0 CM	2
KB 500/00	UTERUS CURETTE SHARP RIGID 31,0 CM 6,0 MM	1
KB 500/01	UTERUS CURETTE SHARP RIGID 31,0 CM 7,0 MM	1
KB 500/03	UTERUS-CURETTE SHARP RIGID 31,0 CM 9,0 MM	1
KB 500/04	UTERUS CURETTE SHARP RIGID 31,0 CM 11,0 MM	1
KU 300/11	MIXING BOWL 116 x 50 MM	1
KU 303/65	INNER BOX ONLY FOR NEEDLE CASE ROUND	1
SK 305/07	WIRE BASKET, 485 X 255 X 70 MM	2
XP 720/43	TELESCOPE 4MM 30°	1
XP 800/07	HYSTEROSCOPY SHEATH 8,0 MM ROTATING 360°	1
XP 805/03	HYSTEROSCOPY SHEATH 3,0 MM 30°	1
XT 035/18	BASIC FIBRE OPTIC CABLE 3,5 MM DIAM.180CM	1
XT 100/01	ADAPTER PROJECTOR SIDE, STORZ	1
XT 100/11	ADAPTER ENDOSCOPE SIDE, STORZ/W+IBE/OLY/S	1

Sterilisation Container KYE 200/71, if required

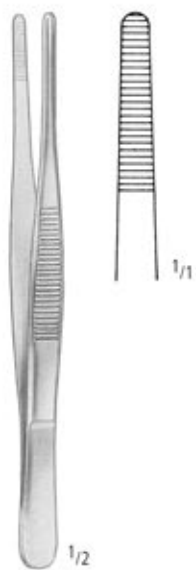

STANDARD
AB 050/20
20,0 cm/8"



GROSS-MAIER
AF 100/27
27,0 cm/10³/₄"

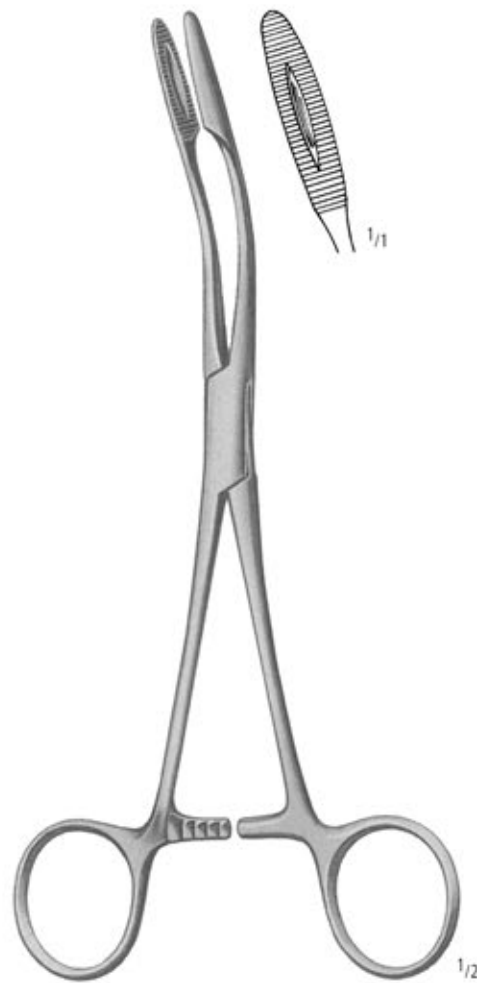

GROSS-MAIER
AF 101/27
27,0 cm/10³/₄"



AO 912/00

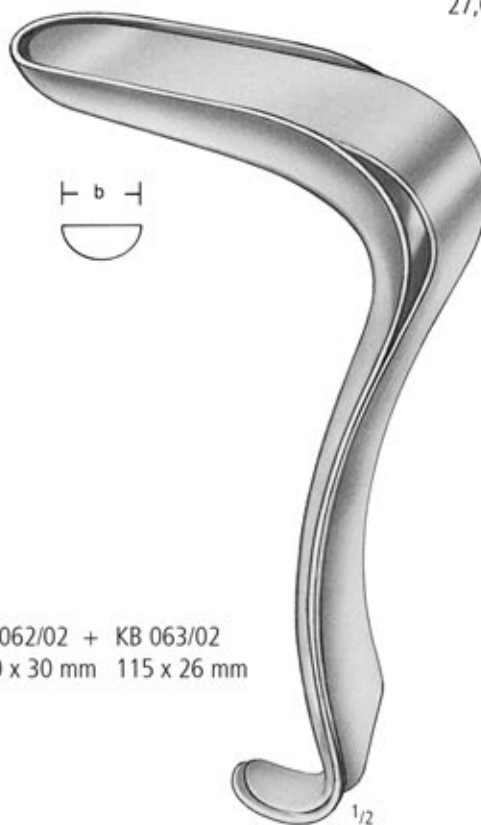

KRISTELLER
Fig. 2
KB 064/02 = KB 062/02 + KB 063/02
110 x 30 mm 115 x 26 mm



HEGAR

1,0 mm	KB 100/02	6,5 mm	KB 100/13
1,5 mm	KB 100/03	7,0 mm	KB 100/14
2,0 mm	KB 100/04	7,5 mm	KB 100/15
2,5 mm	KB 100/05	8,0 mm	KB 100/16
3,0 mm	KB 100/06	8,5 mm	KB 100/17
3,5 mm	KB 100/07	9,0 mm	KB 100/18
4,0 mm	KB 100/08	9,5 mm	KB 100/19
4,5 mm	KB 100/09	10,0 mm	KB 100/20
5,0 mm	KB 100/10	10,5 mm	KB 100/21
5,5 mm	KB 100/11	11,0 mm	KB 100/22
6,0 mm	KB 100/12	11,5 mm	KB 100/23



SCHRÖDER
KB 255/25
25,0 cm/10"



SIMS
KB 201/32
32,0 cm/12 1/2"



RECAMIER / SIMS
31,0 cm/12 1/4"

Fig. 0	6,0 mm	KB 500/00
Fig. 1	7,0 mm	KB 500/01
Fig. 3	9,0 mm	KB 500/03
Fig. 4	11,0 mm	KB 500/04



Ø x h
116 x 50 mm
0,35 l KU 300/11

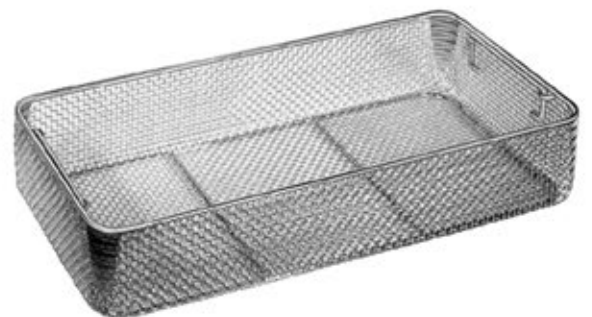

L(mm)	B(mm)	H(mm)	
485	255	70	SK 305/07

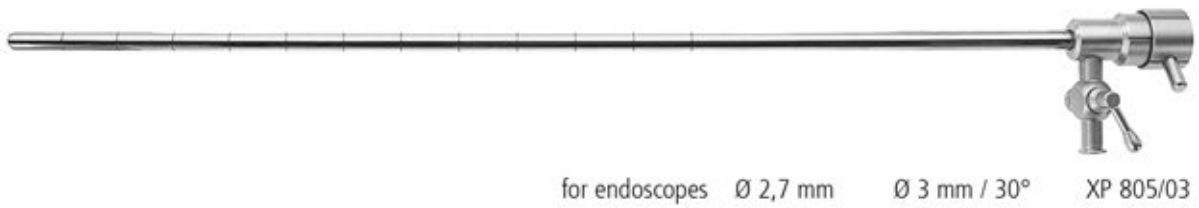
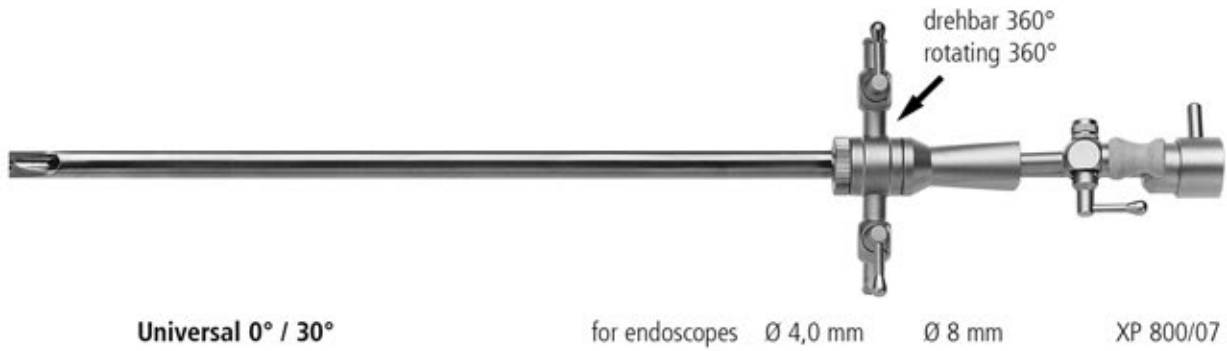
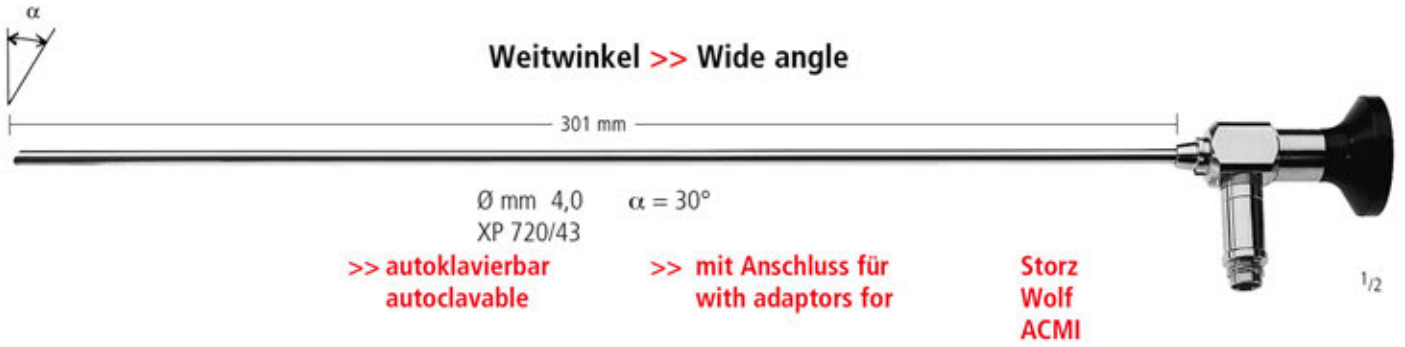

Projektor-Seite
Projector side

Endoskop-Seite
Endoscope side

XT 100/01



STORZ



XT 100/11

STORZ/WINTER + IBE
OPLYMPUS/STRYKER

ZS 140/00 ZS 140/05 ZS 140/10 ZS 140/15 ZS 140/20 ZS 140/25 ZS 140/30 ZS 140/35 ZS 140/40 ZS 140/45 ZS 140/50 ZS 140/55 ZS 981/04 ZS 981/05 ZS 981/06 ZS 981/07 ZS 981/08 ZS 981/09 ZS 981/10 ZS 981/11 ZS 981/12 ZS 981/13 ZS 981/14 ZS 981/15 ZS 981/16 ZS 981/17 ZS 981/18 ZS 981/19 ZS 981/20 ZS 981/21 ZS 981/22 ZS 981/23 ZS 981/24 ZS 981/25 ZS 981/26 ZS 981/27 ZS 981/28 ZS 981/29 ZS 981/30 ZS 981/31 ZS 981/32 ZS 981/33 ZS 981/34 ZS 981/35 ZS 981/36 ZS 981/37 ZS 981/38 ZS 981/39 ZS 981/40 ZS 981/41 ZS 981/42 ZS 981/43 ZS 981/44 ZS 981/45 ZS 981/46 ZS 981/47 ZS 981/48 ZS 981/49 ZS 981/50

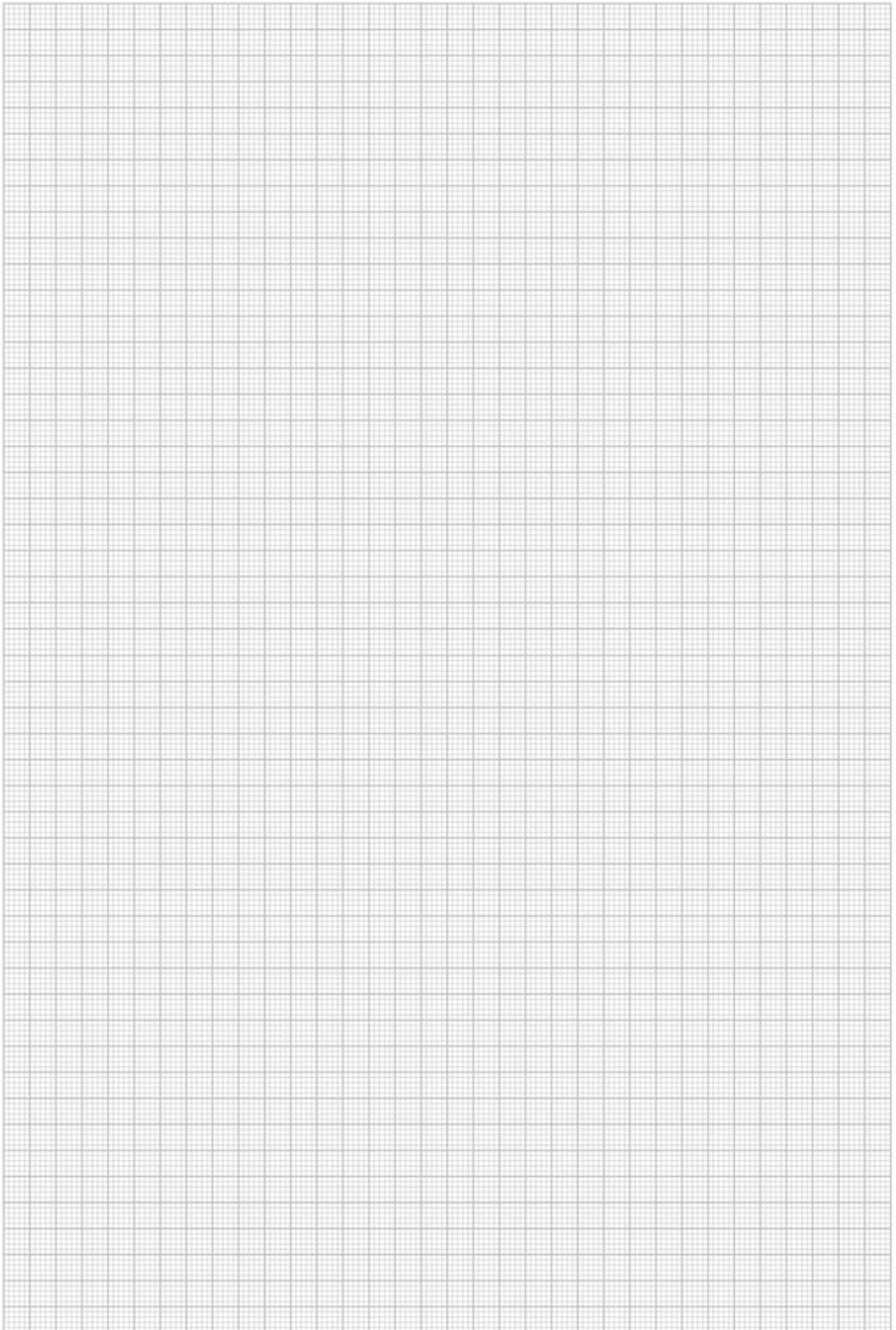

CONISATION

GYN

SET ZS 140/30

Siebvorschlag - Suggested instrument set



ZS 140/30 CONISATION SET

Contents:		Qty
AA 210/24	OCHSNER-KOCHER ART.FCPS.STR 24,0 CM	1
AB 050/20	STANDARD DRESSING FORCEPS STR 20,0 CM	1
AB 060/20	STANDARD TISSUE FCPS. 1X2 T STR 20,0 CM	1
AC 090/20	SIMS GYNEC. SCISSORS STR BL/BL 20,0 CM	1
AC 091/20	SIMS GYNEC.SCISSORS CVD BL/BL 20,0 CM	1
AD 010/03	SCALPEL HANDLE NO.3	1
AD 020/13	SCALPEL HANDLE NO.3 L	1
AE 487/24	WERTHEIM NEEDLE HOLDER TUC S-CVD 24,0 CM	1
AF 100/27	GROSS-MAIER DRESSING FCPS STR 27,0 CM	2
AF 101/27	GROSS-MAIER DRESSING FCPS CVD 27,0 CM	1
KB 064/02	KRISTELLER VAGINAL SPECULA SET FIG. 2	1
KB 078/11	BLADE ONLY FOR SCHERBACK SPECULA	1
KB 078/12	BLADE ONLY FOR SCHERBACK SPECULA	1
KB 078/20	HANDLE ONLY FOR SCHERBACK SPECULA	1
KB 078/40	WEIGHT ONLY FOR SCHERBACK SPECULA, 400G	1
KB 093/25	BREISKY VAG.SPEC.BAYONET SH.130X25 MM	1
KB 093/30	BREISKY VAG.SPEC.BAYONET SH.130X30 MM	2
KB 093/35	BREISKY VAG.SPEC.BAYONET SH.130X35 MM	1
KB 100/04	HEGAR UT.DILATOR W.SLOPED HDL 2,0 MM	1
KB 100/05	HEGAR UT.DILATOR W.SLOPED HDL 2,5 MM	1
KB 100/06	HEGAR UT.DILATOR W.SLOPED HDL 3,0 MM	1
KB 100/07	HEGAR UT.DILATOR W.SLOPED HDL 3,5 MM	1
KB 100/08	HEGAR UT.DILATOR W.SLOPED HDL 4,0 MM	1
KB 100/09	HEGAR UT.DILATOR W.SLOPED HDL 4,5 MM	1
KB 100/10	HEGAR UT.DILATOR W.SLOPED HDL 5,0 MM	1
KB 100/11	HEGAR UT.DILATOR W.SLOPED HDL 5,5 MM	1
KB 100/12	HEGAR UT.DILATOR W.SLOPED HDL 6,0 MM	1
KB 100/13	HEGAR UT.DILATOR W.SLOPED HDL 6,5 MM	1
KB 100/14	HEGAR UT.DILATOR W.SLOPED HDL 7,0 MM	1
KB 100/15	HEGAR UT.DILATOR W.SLOPED HDL 7,5 MM	1
KB 100/16	HEGAR UT.DILATOR W.SLOPED HDL 8,0 MM	1
KB 100/17	HEGAR UT.DILATOR W.SLOPED HDL 8,5 MM	1
KB 100/18	HEGAR UT.DILATOR W.SLOPED HDL 9,0 MM	1
KB 100/19	HEGAR UT.DILATOR W.SLOPED HDL 9,5 MM	1
KB 100/20	HEGAR UT.DILATOR W.SLOPED HDL 10,0 MM	1
KB 100/21	HEGAR UT.DILATOR W.SLOPED HDL 10,5 MM	1
KB 100/22	HEGAR UT.DILATOR W.SLOPED HDL 11,0 MM	1
KB 100/23	HEGAR UT.DILATOR W.SLOPED HDL 11,5 MM	1
KB 200/32	SIMS UTERINE SOUND RIGID 32,0 CM	1
KB 255/25	SCHROEDER FORCEPS BOX LOCK, 25,0 CM	2
KB 500/01	UTERUS CURETTE SHARP RIGID 31,0 CM 7,0 MM	1
KB 500/02	UTERUS CURETTE SHARP RIGID 31,0 CM 8,0 MM	1
KB 500/05	UTERUS CURETTE SHARP RIGID 31,0 CM 12,0 MM	1
KB 500/06	UTERUS CURETTE SHARP RIGID 31,0 CM 14,0 MM	1
KU 300/11	MIXING BOWL 116 x 50 MM	2
KU 302/25	KIDNEY TRAY 250 MM	1
KU 303/65	INNER BOX ONLY FOR NEEDLE CASE ROUND	1
XR 803/05	ELECTR HANDLE W. CABLE FOR MARTIN/BERCH	1
XR 841/09	UNIVERSAL-ELECTRODES	1
XR 841/10	UNIVERSAL-ELECTRODES	1
XR 843/04	UNIVERSAL-ELECTRODES	1
XR 843/05	UNIVERSAL-ELECTRODES	1
SK 307/05	WIRE BASKET, 485 X 255 X 50 MM	2

Sterilization Container KYE 200/71, if required

ZS 140/30 CONISATION SET

GYN

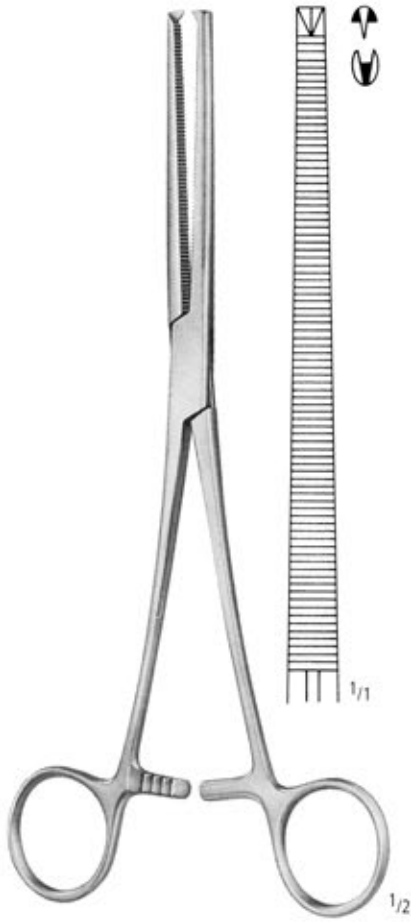

OCHSNER-KOCHER 1:2
AA 210/24
24,0 cm/9 1/2"

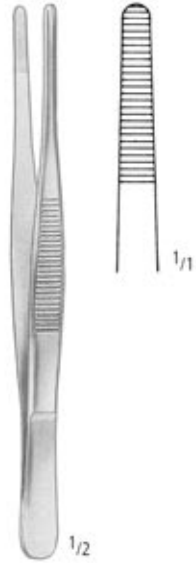

STANDARD
AB 050/20
20,0 cm/8"

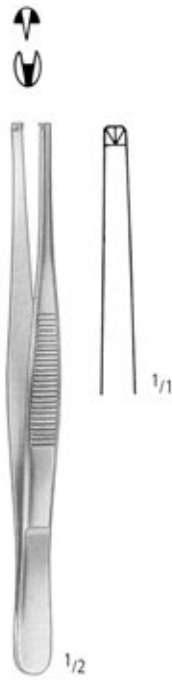

STANDARD 1:2
AB 060/20
20,0 cm/8"



gerade
straight
rectas
droits
rette

SIMS
AC 090/20
20,0 cm/8"

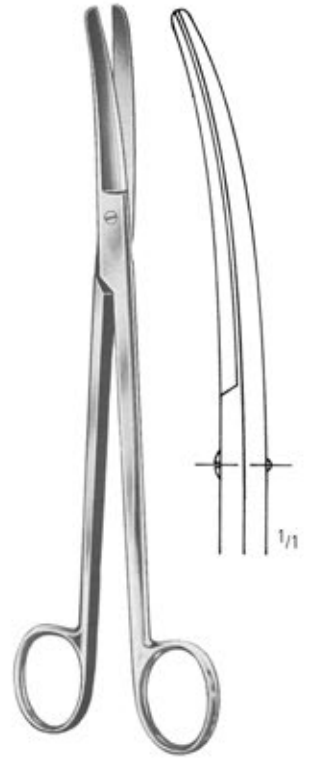

SIMS
AC 091/20
20,0 cm/8"

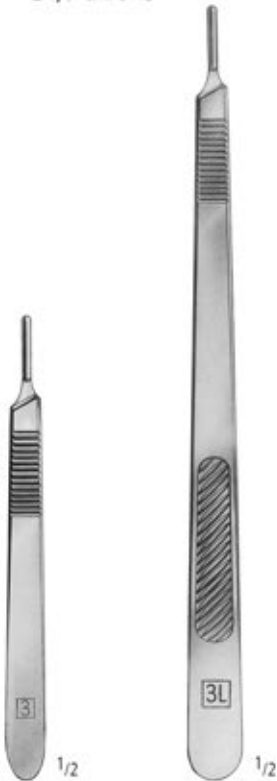

AD 010/03
No. 3

AD 020/13
No. 3L

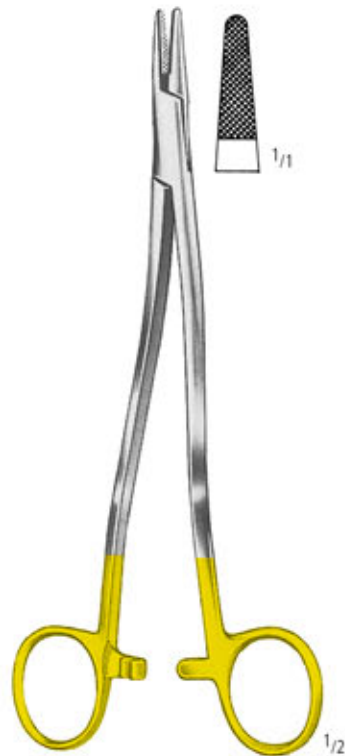

WERTHEIM
AE 487/24
24,0 cm/9 1/2"

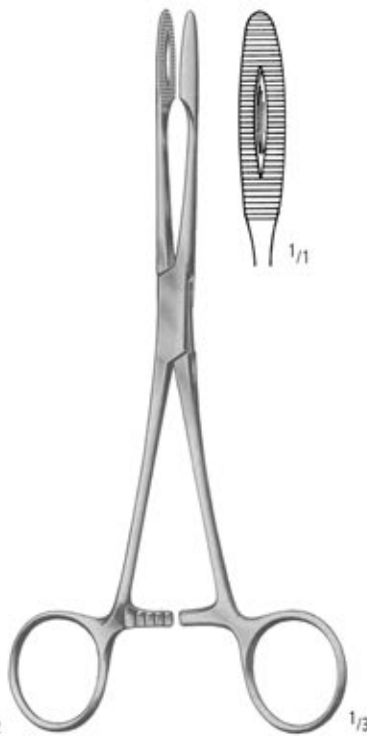

GROSS-MAIER
AF 100/27
27,0 cm/10 3/4"

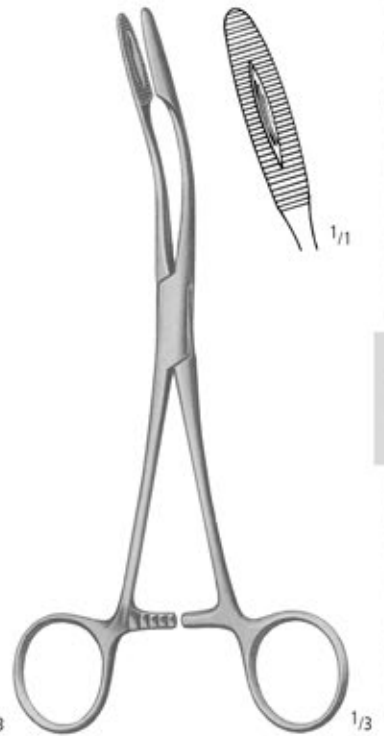

GROSS-MAIER
AF 101/27
27,0 cm/10 3/4"

ZS 140/00 ZS 140/05 ZS 140/10 ZS 140/15 ZS 140/20 ZS 140/25 ZS 140/30 ZS 140/35 ZS 140/40 ZS 140/45 ZS 140/50 ZS 140/55 ZS 140/60 ZS 140/65 ZS 140/70 ZS 140/75 ZS 140/80 ZS 140/85 ZS 140/90 ZS 140/95 ZS 981/00 ZS 981/05 ZS 981/10 ZS 981/15 ZS 981/20 ZS 981/25 ZS 981/30 ZS 981/35 ZS 981/40 ZS 981/45 ZS 981/50 ZS 981/55 ZS 981/60 ZS 981/65 ZS 981/70 ZS 981/75 ZS 981/80 ZS 981/85 ZS 981/90 ZS 981/95 ZS 981/00 ZS 981/05 ZS 981/10 ZS 981/15 ZS 981/20 ZS 981/25 ZS 981/30 ZS 981/35 ZS 981/40 ZS 981/45 ZS 981/50 ZS 981/55 ZS 981/60 ZS 981/65 ZS 981/70 ZS 981/75 ZS 981/80 ZS 981/85 ZS 981/90 ZS 981/95

URO

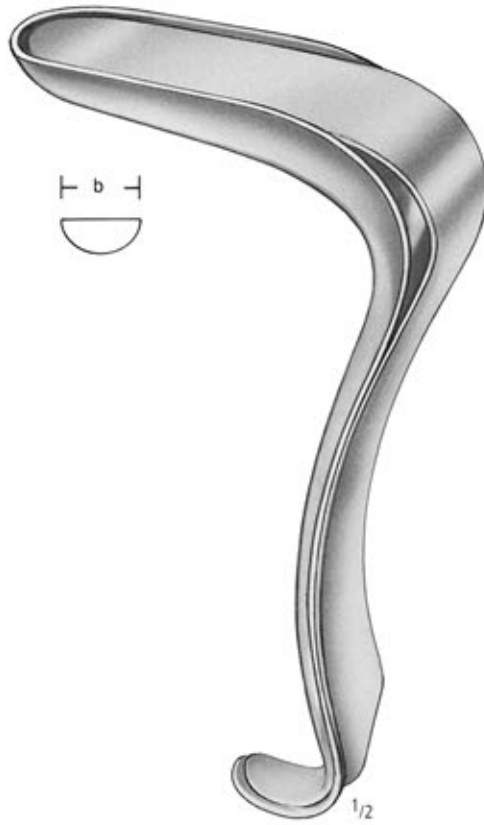

BREISKY

- 130 x 25 mm KB 093/25
- 130 x 30 mm KB 093/30
- 130 x 35 mm KB 093/35



KRISTELLER

Fig. 2

- KB 064/02 = KB 062/02 + KB 063/02
- 110 x 30 mm 115 x 26 mm

fest
rigid
rigida
rigide
rigido



- 2,0 mm KB 100/04
- 2,5 mm KB 100/05
- 3,0 mm KB 100/06
- 3,5 mm KB 100/07
- 4,0 mm KB 100/08
- 4,5 mm KB 100/09
- 5,0 mm KB 100/10
- 5,5 mm KB 100/11
- 6,0 mm KB 100/12
- 6,5 mm KB 100/13
- 7,0 mm KB 100/14
- 7,5 mm KB 100/15
- 8,0 mm KB 100/16
- 8,5 mm KB 100/17
- 9,0 mm KB 100/18
- 9,5 mm KB 100/19
- 10,0 mm KB 100/20
- 10,5 mm KB 100/21
- 11,0 mm KB 100/22
- 11,5 mm KB 100/23

SCHERBACK
400 g = KB 078/40

HEGAR

SIMS
KB 200/32
32,0 cm/12 1/2"



SCHRÖDER
KB 255/25
25,0 cm/10"



scharf
sharp
cortante
tranchante
taglienti

Ø x h
116 x 50 mm 0,35 l KU 300/11

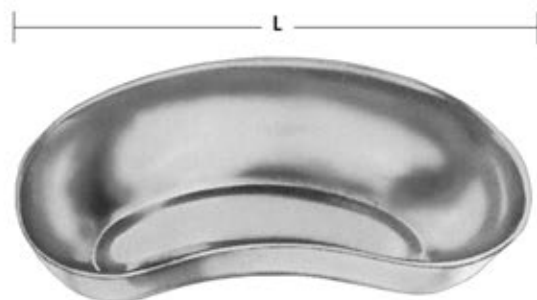

L = 250 mm KU 302/25



monopolar

universal



MARTIN / BERCHTHOLD
XR 803/05



XR 841/09



XR 841/10



XR 843/04



XR 843/05

RECAMIER / SIMS
31,0 cm/12 1/4"

- Fig. 1 7,0 mm KB 500/01
- Fig. 2 8,0 mm KB 500/02
- Fig. 5 12,0 mm KB 500/05
- Fig. 6 14,0 mm KB 500/06

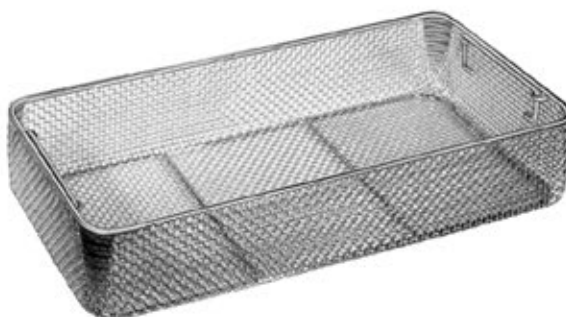

L(mm)	B(mm)	H(mm)	
485	255	70	SK 305/07

CAESAREAN SECTION

GYN

SET

ZS 140/35

Siebvorschlag - Suggested instrument set



ZS 140/35 CAESAREAN SECTION SET

Contents:		Qty
AA 200/24	ROCHESTER-PEAN ARTERY FCPS STR 24,0 CM	2
AA 210/24	OCHSNER-KOCHER ART.FCPS.STR 24,0 CM	4
AA 216/14	KOCHER-DELICATE ART.FCPS.STR 1X2T 14,0 CM	4
AA 221/02	OVERHOLT-GEISSENDOERFER FIG.2 21,0 CM	2
AA 558/25	NON-TRAUMATIC HAEMORRHOIDAL FORCEPS 25,0 CM	1
AB 050/20	STANDARD DRESSING FORCEPS STR 20,0 CM	1
AB 060/20	STANDARD TISSUE FCPS. 1X2 T STR 20,0 CM	2
AB 060/25	STANDARD TISSUE FCPS. 1X2 T STR 25,0 CM	1
AB 080/14	TISSUE FORCEPS NARROW 1X2 TEETH 14,5 CM	2
AB 862/20	DE BAKEY ATRAUMA FCPS STR 2.0MM 20,0 CM	1
AC 011/15	STANDARD OPER.SCS. CVD.BL/BL 15,5 CM	1
AC 091/20	SIMS SCISSORS CVD BL/BL 20,0 CM	1
AC 919/23	SIMS GYN SCISSORS TUC CURVED 23,0 CM	1
AC 941/23	METZENBAUM SCS TUC CVD BL/BL 23,0 CM	1
AD 010/04	SCALPEL HANDLE NO.4	1
AE 400/20	MAYO-HEGAR NEEDLE HOLDER TUC 20,0 CM	1
AE 400/24	MAYO-HEGAR NEEDLE HOLDER TUC 24,0 CM	1
AE 470/15	CRILE-WOOD NEEDLE HOLDER TUC 15,0 CM	1
AF 100/27	GROSS-MAIER DRESSING FCPS STR 27,0 CM	4
AF 101/27	GROSS-MAIER DRESSING FCPS CURVED 27,0 CM	1
AF 201/25	FOERSTER-BALLENGER CVD SERRATED 25,0 CM	4
AK 254/75	FRITSCH RETRACTOR 45X75 MM 24,0 CM	2
AK 350/02	ROUX RETRACTOR FIG.2	2
KB 500/02	UTERUS CURETTE SHARP RIGID 31,0 CM 8,0 MM	1
KB 734/30	SIMPSON OBSTETRICAL FCPS 30,0 CM	1
KU 302/25	KIDNEY TRAY 250 MM	2
XR 830/03	CORDS,CONN.MARTIN/BERCHTOLD,300CM,BIPOL	1
XR 896/20C	BI-COAGULATION-FORCEPS,20,0CM,1,0 MM	1
SK 307/05	WIRE BASKET, 540 X 255 X 50 MM	1

Sterilization Container KYE 200/51, if required

ZS 140/35 CAESAREAN SECTION SET

GYN

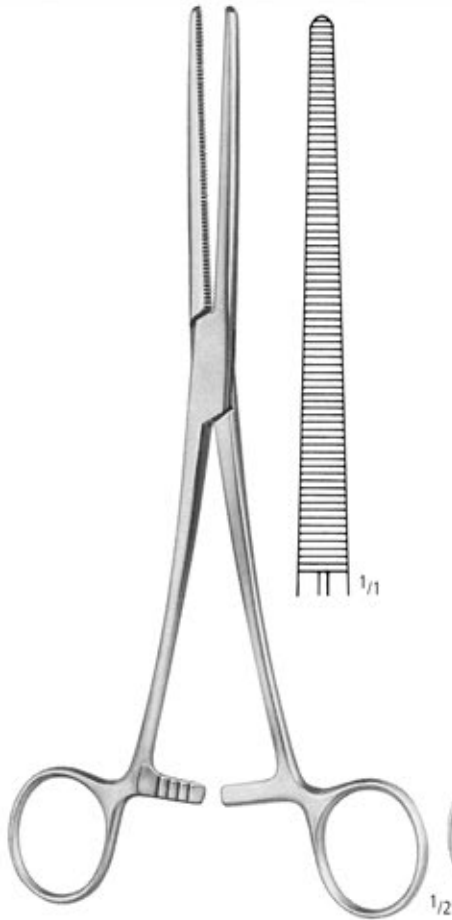

ROCHESTER-PEAN
AA 200/24
24,0 cm/9½"



OCHSNER-KOCHER 1:2
AA 210/24
24,0 cm/9½"

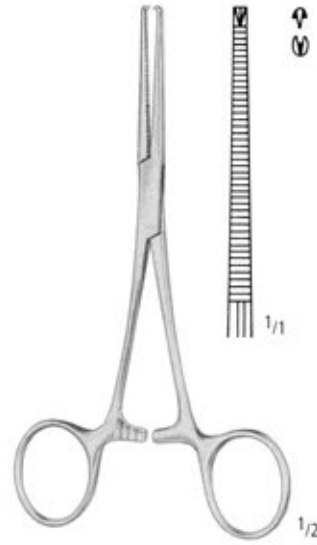

KOCHER 1:2 - DELICATE
AA 216/14
14,0 cm/5½"

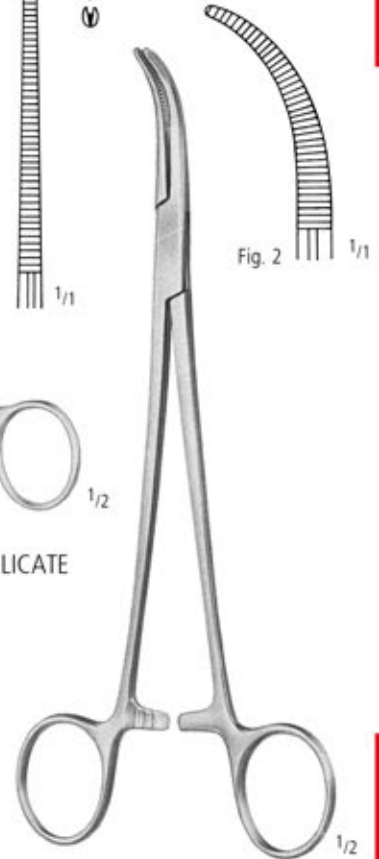

OVERHOLT-GEISSENDOERFER
AA 221/02
21,0 cm/8¼"

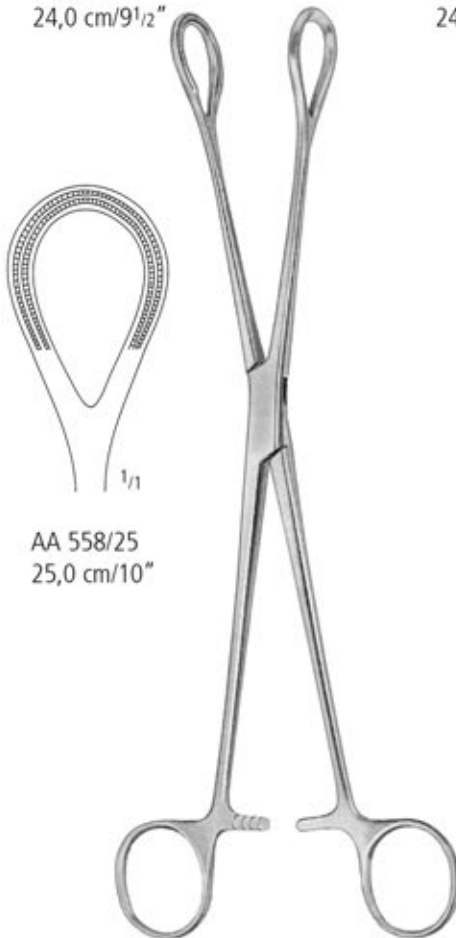

AA 558/25
25,0 cm/10"

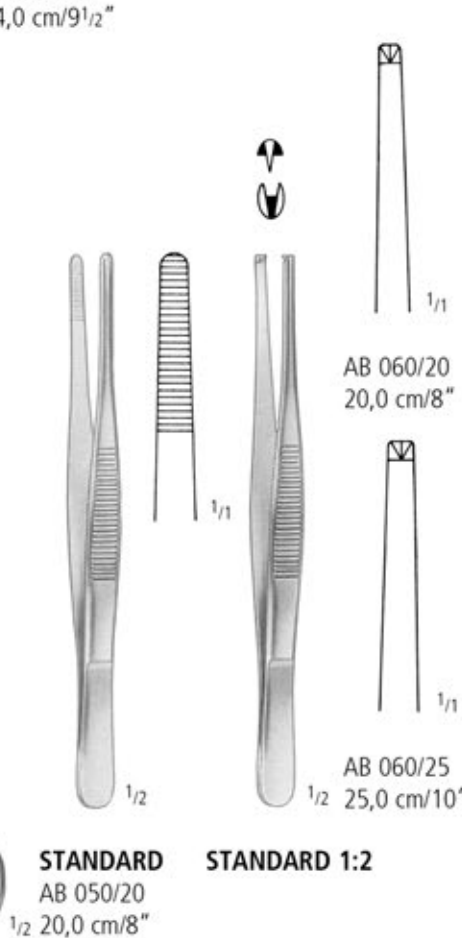

STANDARD
AB 050/20
½ 20,0 cm/8"

STANDARD 1:2

AB 060/20
20,0 cm/8"

AB 060/25
25,0 cm/10"

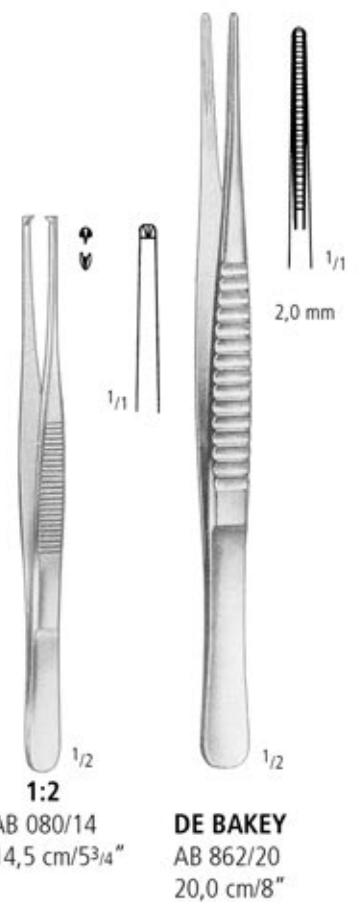

1:2
AB 080/14
14,5 cm/5¾"

DE BAKERY
AB 862/20
20,0 cm/8"

ZS 140/00 ZS 140/05 ZS 140/10 ZS 140/15 ZS 140/20 ZS 140/25 ZS 140/30 ZS 140/35 ZS 140/40 ZS 140/45 ZS 140/50 ZS 140/55 ZS 140/60 ZS 981/04 ZS 981/05 ZS 981/06 ZS 981/07 ZS 981/08 ZS 981/09 ZS 981/10 ZS 981/11 ZS 981/12 ZS 981/13 ZS 981/14 ZS 981/15 ZS 981/16 ZS 981/17 ZS 981/18 ZS 981/19 ZS 981/20 ZS 981/21 ZS 981/22 ZS 981/23 ZS 981/24 ZS 981/25 ZS 981/26 ZS 981/27 ZS 981/28 ZS 981/29 ZS 981/30 ZS 981/31 ZS 981/32 ZS 981/33 ZS 981/34 ZS 981/35 ZS 981/36 ZS 981/37 ZS 981/38 ZS 981/39 ZS 981/40 ZS 981/41 ZS 981/42 ZS 981/43 ZS 981/44 ZS 981/45 ZS 981/46 ZS 981/47 ZS 981/48 ZS 981/49 ZS 981/50

URO

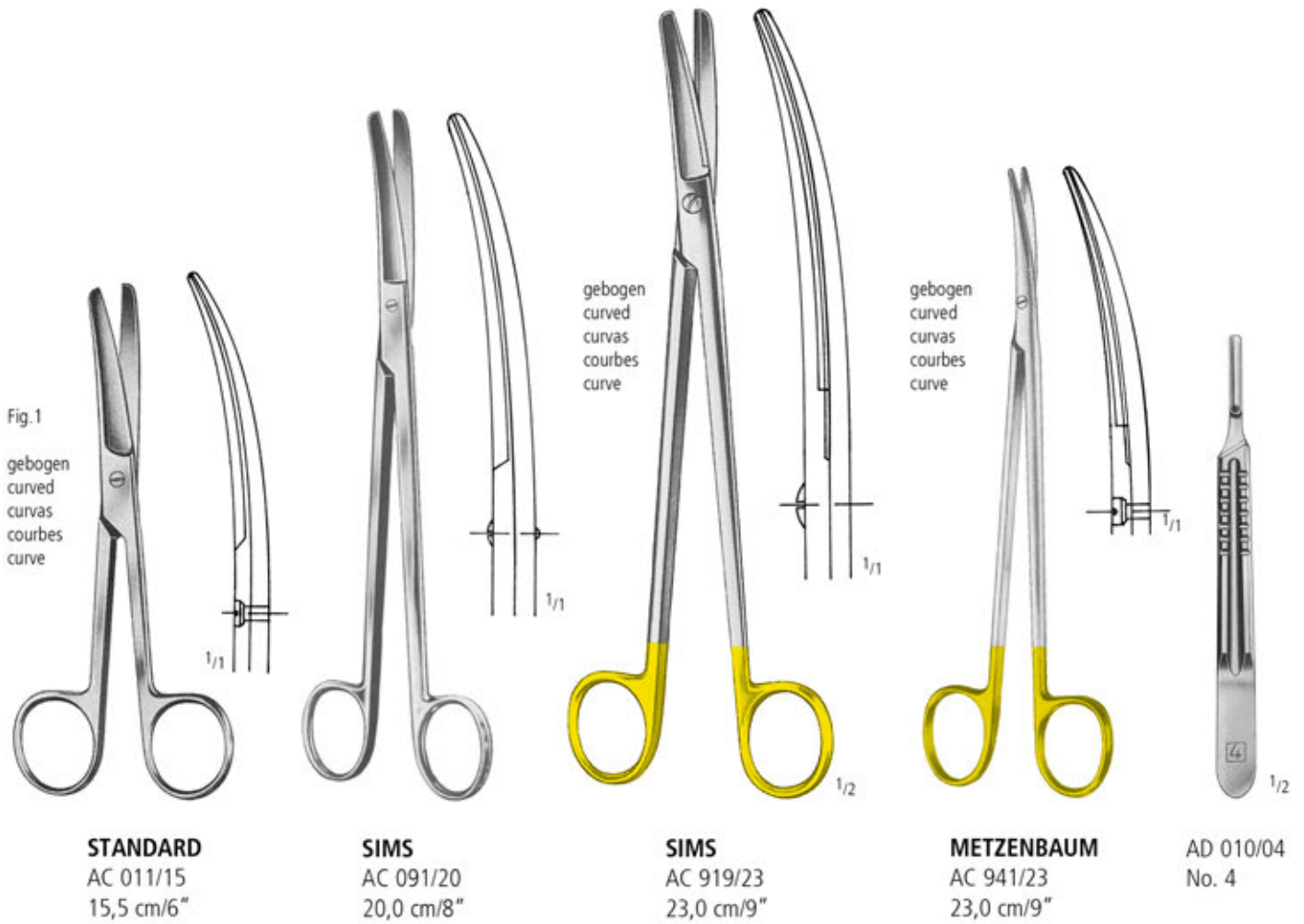

ZS 140/35 CAESAREAN SECTION SET

GYN

scharf
sharp
cortante
tranchante
taglienti



RECAMIER / SIMS
KB 500/02
Fig. 2 8,0 mm
31,0 cm / 12 1/4"

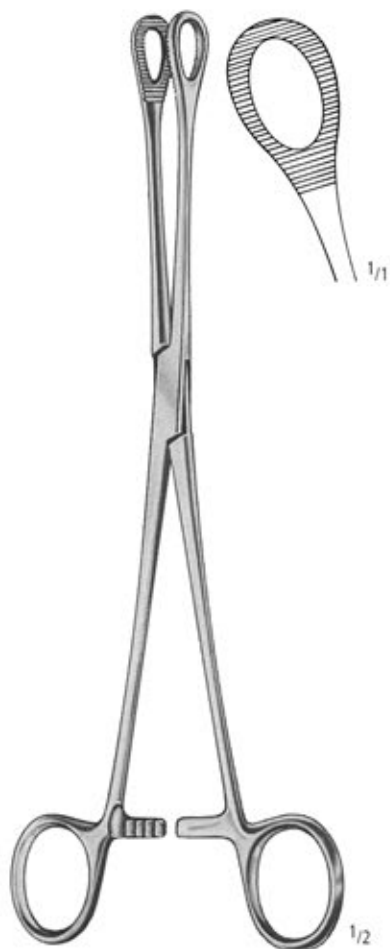

FOERSTER-BALLENGER
AF 201/25
25,0 cm / 10"

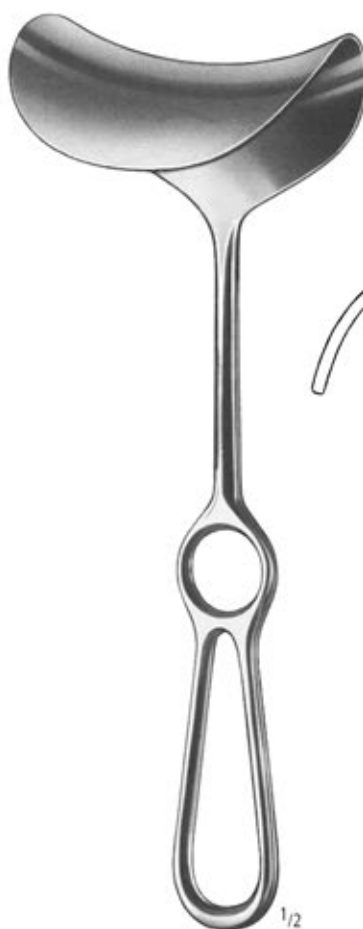

FRITSCH
AK 254/75
45 x 75 mm
24,0 cm / 9 1/2"

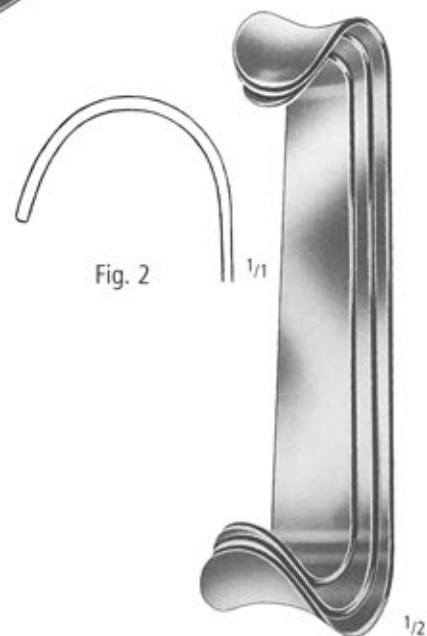

ROUX
16,5 cm / 6 1/2"
AK 350/02



SIMPSON
KB 734/30
30,0 cm / 12"



L = 250 mm KU 302/25

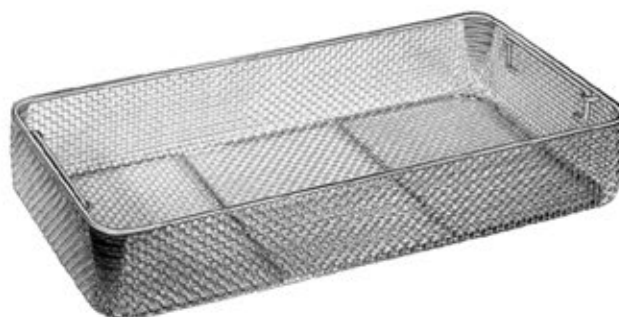

L(mm) B(mm) H(mm)
540 255 50 SK 307/05

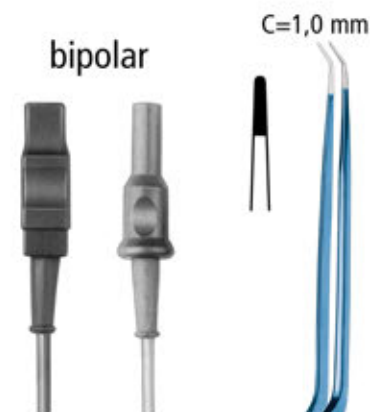

MARTIN / BERCHTHOLD
300 cm XR 830/03



XR 896/20C
20,0 cm / 8"

ZS 140/00 ZS 140/05 ZS 140/10 ZS 140/25 ZS 140/30 ZS 140/35 ZS 140/40 ZS 140/45 ZS 140/55 ZS 981/04 ZS 140/55 ZS 140/45 ZS 981/04 ZS 140/55 ZS 981/01 ZS 145/05 ZS 981/02

URO

PARTUS

GYN

SET ZS 140/40

Siebvorschlag - Suggested instrument set



ZS 140/40 PARTUS SET

Contents:		Qty
AA 200/18	ROCHESTER-PEAN ARTERY FCPS STR 18,0 CM	1
AA 210/18	OCHSNER-KOCHER FORCEPS STR 18,0 CM	1
AA 751/08	BACKHAUS TOWEL FORCEPS 8,0 CM	2
AB 050/14	STANDARD DRESSING FORCEPS STR 14,5 CM	1
AB 060/14	STANDARD TISSUE FCPS. 1X2 T STR 14,5 CM	1
AC 351/14	BRAUN-STADLER EPISIOTOMY SCS 14,0 CM	1
AC 365/13	BUSCH UMBILICAL SCISSORS 13,0 CM	1
AD 010/03	SCALPEL HANDLE NO. 3	1
AD 075/10	PCK=100 BLADES FIG.10	1
AE 100/14	MAYO-HEGAR NEEDLE HOLDER 14,0 CM	1
AR 310/02	PINARD STETHOSCOPE OF ALUMINUM 15,0 CM	1
KU 302/25	KIDNEY TRAY 250 MM	1
KU 312/20	INTRUMENT BOX 20,0 x 10,0 x 5,0 CM	1
SK 105/05	WIRE BASKET, 255 X 245 X 50 MM	1

Sterilization Container KYE 200/11, if required

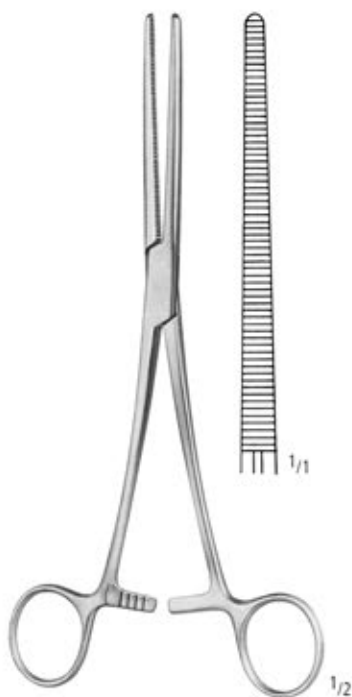

ROCHESTER-PEAN
AA 200/18
18,0 cm/7"

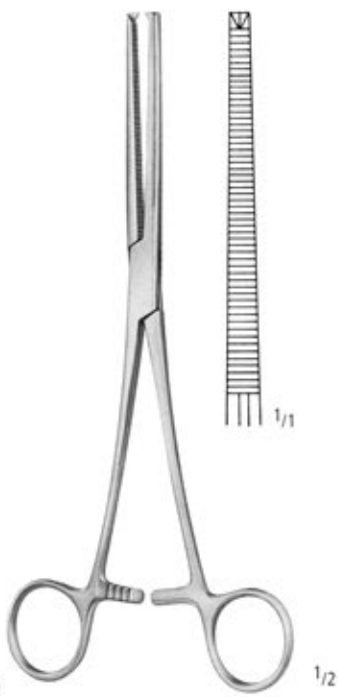

OCHSNER-KOCHER 1:2
AA 210/18
18,0 cm/7"

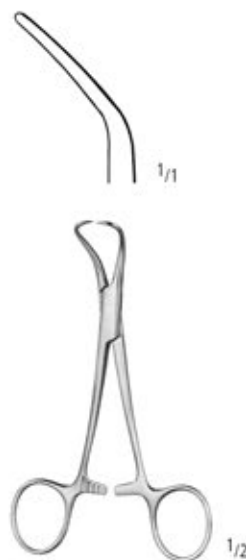

BACKHAUS
AA 751/08
8,0 cm/3"

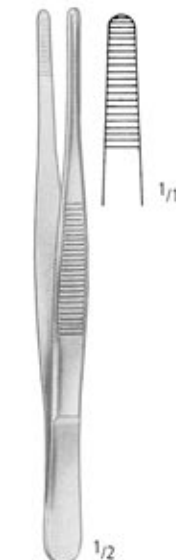

STANDARD
AB 050/14
14,5 cm/5³/₄"



1:2 STANDARD
AB 060/14
14,5 cm/5³/₄"

aus Aluminium
of aluminium
de aluminio
en aluminium
in alluminio



BRAUN-STADLER
AC 351/14
14,0 cm/5¹/₂"



BUSCH
AC 365/13
13,0 cm/5"



AD 010/03
No. 3



Fig.10
AD 075/10



MAYO-HEGAR
AE 100/14
14,0 cm/5¹/₂"



PINARD
AR 310/02



L = 250 mm KU 302/25



l x b x h
20,0 x 10,0 x 5,0 cm KU 312/20



L(mm)	B(mm)	H(mm)	
255	245	50	SK 105/05

DELIVERY

GYN

SET ZS 140/45

Siebvorschlag - Suggested instrument set



**ZS 140/45** DELIVERY SET

Contents:		Qty
AA 210/14	OCHSNER-KOCHER FCPS. STR. 14,0 CM	2
AC 365/16	BUSCH UMBILICAL SCISSORS 16,0 CM	1
AF 100/22	GROSS-MAIER DRESSING FCPS STR 22,0 CM	1

Sterilization Container KYE 351/03, if required

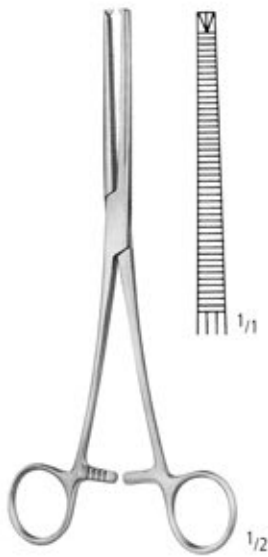

OCHSNER-KOCHER 1:2
AA 210/14
14,0 cm/5½"



BUSCH
AC 365/16
16,0 cm/6¼"

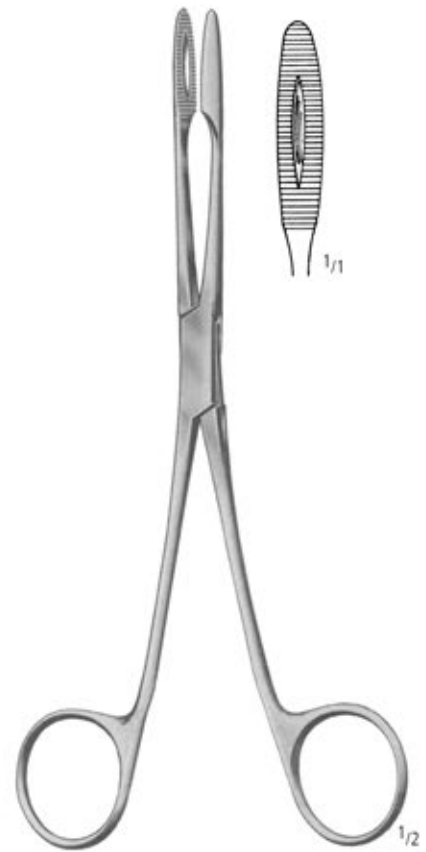

GROSS-MAIER
AF 102/22
22,0 cm/8¾"

DILATATION / CURETTAGE

GYN

SET ZS 140/55

Siebvorschlag - Suggested instrument set



ZS 140/55 DILATATION / CURETTAGE SET

Contents:		Qty
AB 050/20	STANDARD DRESSING FORCEPS STR 20,0 CM	1
AC 091/20	SIMS SCISSORS CVD BL/BL 20,0 CM	1
AF 070/27	ULRICH POLYPUS FORCEPS STR 27,0 CM	1
AF 101/27	GROSS-MAIER DRESSING FCPS CVD 27,0 CM	1
KB 046/12	GRAVE SPECIAL VAGINAL SPECULA W/SUCTION, OPEN	1
KB 055/03	KRISTELLER VAGINAL SPECULA SET FIG.3	1
KB 255/25	SCHROEDER FORCEPS BOX LOCK, 25,0 CM	2
KB 500/04	UTERINE CURETTE SHARP RIGID 31,0 CM 11 MM FIG.4	1
KB 550/06	UTERINE CURETTE BLUNT RIGID 31,0 CM 14 MM FIG.6	1
KB 550/08	UTERINE CURETTE BLUNT RIGID 31,0 CM 16 MM FIG.8	1
KB 550/09	UTERINE CURETTE BLUNT RIGID 31,0 CM 19 MM FIG.9	1
KB 550/12	UTERINE CURETTE BLUNT RIGID 31,0 CM 23 MM FIG.12	1
KB 781/03	WINTER OVUM FORCEPS FIG.3 CVD 28,0 CM	1
KU 300/11	MIXING BOWL 116 x 50 MM	1
SK 305/05	WIRE BASKET, 485 X 255 X 50 MM	1

Sterilization Container KYE 200/51, if required

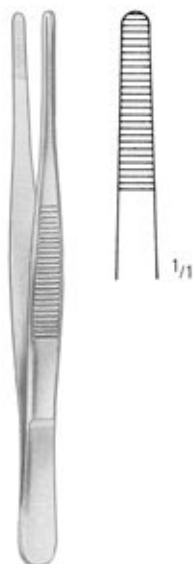

STANDARD
AB 050/20
20,0 cm/8"



SIMS
AC 091/20
20,0 cm/8"

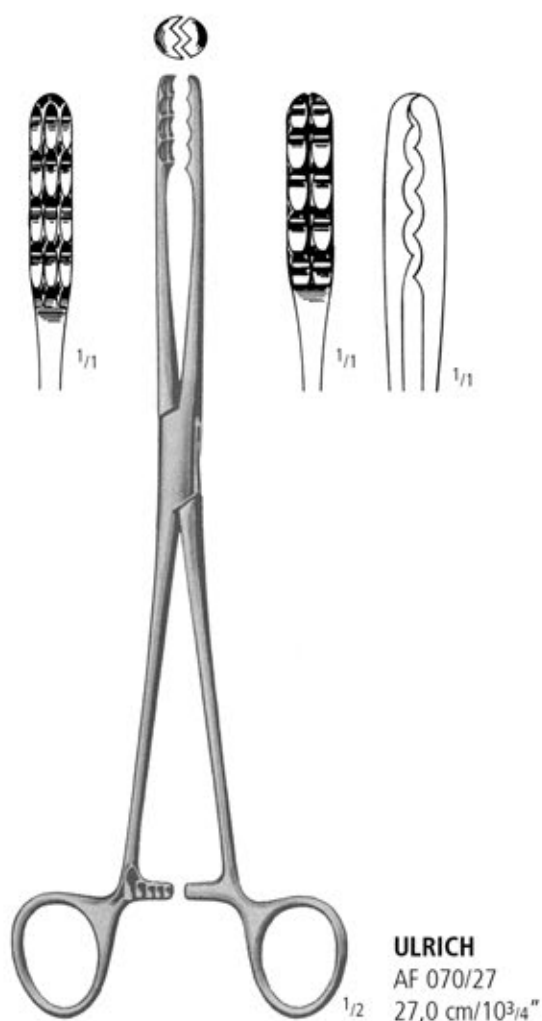

ULRICH
AF 070/27
27,0 cm/10³/₄"

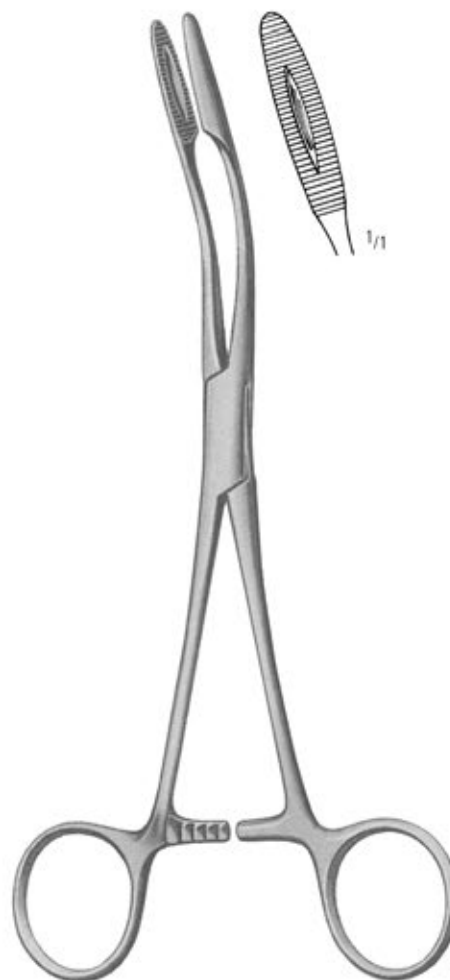

GROSS-MAIER
AF 101/27
27,0 cm/10³/₄"

101 x 35 mm

Absaugung am oberen Blatt
Suction tube on upper blade
Tubo de succión en la valva superior
Canule d'aspiration à la lame supérieure
Canula d'aspirazione alla valva superiore

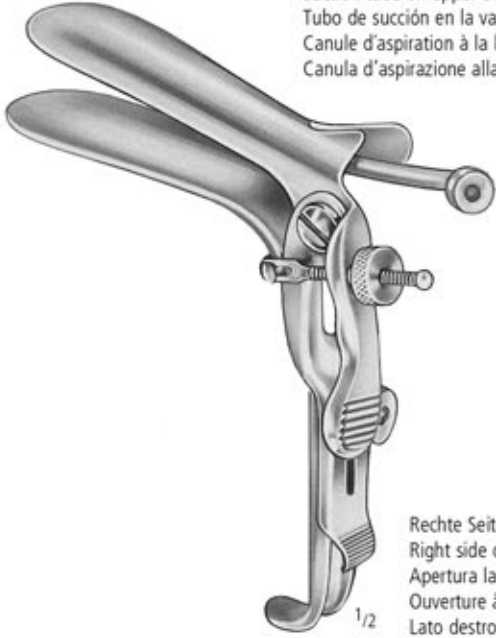

Rechte Seite offen
Right side open
Apertura lateral derecha
Ouverture à droite
Lato destro aperto

GRAVE SPECIAL
KB 046/12

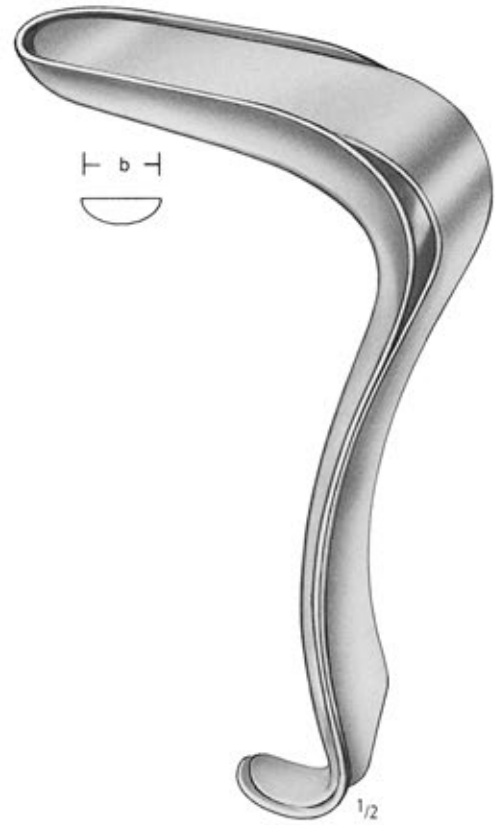

KRISTELLER

Fig. 3
KB 055/03 = KB 053/03 + KB 054/03
90 x 36 mm 100 x 32 mm



SCHRÖDER
KB 255/25
25,0 cm/10"



scharf
sharp
cortante
tranchante
taglianti

1/2

RECAMIER / SIMS

31,0 cm/12 1/4"

Fig. 4 11,0 mm KB 500/04



stumpf
blunt
romo
mousse
smusse

1/2

RECAMIER / SIMS

31,0 cm/12 1/4"

Fig. 6 14,0 mm KB 550/06

Fig. 8 16,0 mm KB 550/08

Fig. 9 19,0 mm KB 550/09

Fig. 12 23,0 mm KB 550/12

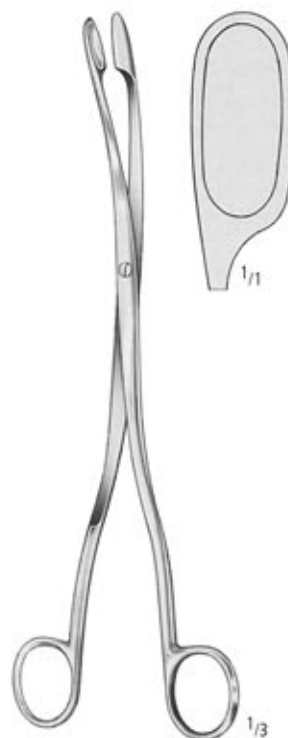

1/1

1/3

WINTER

28,0 cm/11"

Fig. 3 KB 781/03



Ø x h

116 x 50 mm

0,35 l

KU 300/11

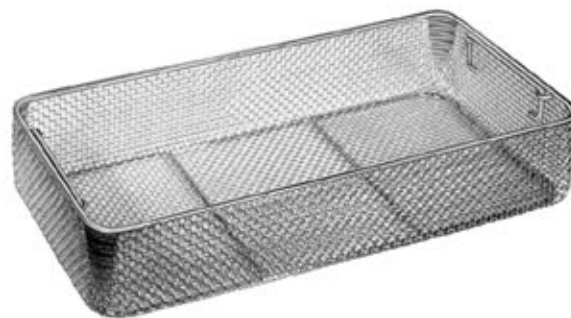

L(mm)

B(mm)

H(mm)

485

255

50

SK 305/05

HYSTEROSCOPY BASIC

Endoscopy

GYN

SET

ZS 981/04

Siebvorschlag - Suggested instrument set



ZS 981/04 HYSTEROSCOPY BASIC SET

Contents:		Qty
XK 935/20	GRASPING FORCEPS, 5 CH.	1
XK 936/20	GRASPING FORCEPS, 5 CH.	1
XK 937/20	GRASPING FORCEPS, 5 CH.	1
XM 500/00	WORKING UNIT, COMPLETE, PASSIVE, ROTATABLE	1
XM 501/25	RESECTOSCOPE SHEATH, Ø 24 CH., CERAMIC WITH OBTURATOR	1
XM 510/02	ELECTRODE LOOP 30°	1
XM 510/04	ELECTRODE LOOP STRAIGHT	1
XM 512/03	ELECTRODE, Ø 3,0 MM, VAPORISATION	1
XP 720/43	TELESCOPE, Ø 4,0 MM, 30°	1
XP 800/07	HYSTEROSCOPY SHEATH, Ø 8,0 MM, ROTATING 360°	1
XP 803/83	HYSTEROCOPY CONTINUOUS FLOW SHEATH, Ø 8,0 MM, 30°	1
SK 307/05	WIRE BASKET, 540 x 255 x 50 MM	1
SU 515/46	WIRE BASKET, 460 x 80 x 52 MM	1

Sterilizing Container KYE 200/51, if required.

Optional additional Equipment to Basic Set:

XT 035/23	BASIC FIBRE OPTIC CABLE, Ø 3,5 MM, DIAM., 230,0 CM	1
XT 100/01	ADAPTER PROJECTOR SIDE, STORZ	1
XT 100/11	ADAPTER ENDOSCOPE SIDE, STORZ	1
XT 200/00	COLD LIGHT SOURCE, XENON, 100 W, 230 VAC	1
XT 301/00	NOPACAM CAMERA SYSTEM, FUTURE 200 PAL., C-MOUNT WITH ADAPTOR, 35,0 MM	1
XT 400/19	LCD MONITOR 19", ANALOG (D-SUB), DVI-D, S-VIDEO, AV COMP, AC 100 - 240 V	1
XU 140/02	NOPAFLOW 16 L, PIN-INDEX-CONNECTION FOR CO2	1
XU 140/70	CO2-CYLINDER, PIN-INDEX, 0,75 KG CONTENTS	1
XU 170/00	HYSTEROCOPY PUMP, COMPLETE	1
XU 800/40	NOPAMOBIL 100, CLOSED	1

For further details/pictures see page 498 ff.

ZS 981/04 HYSTEROSCOPY BASIC SET

GYN

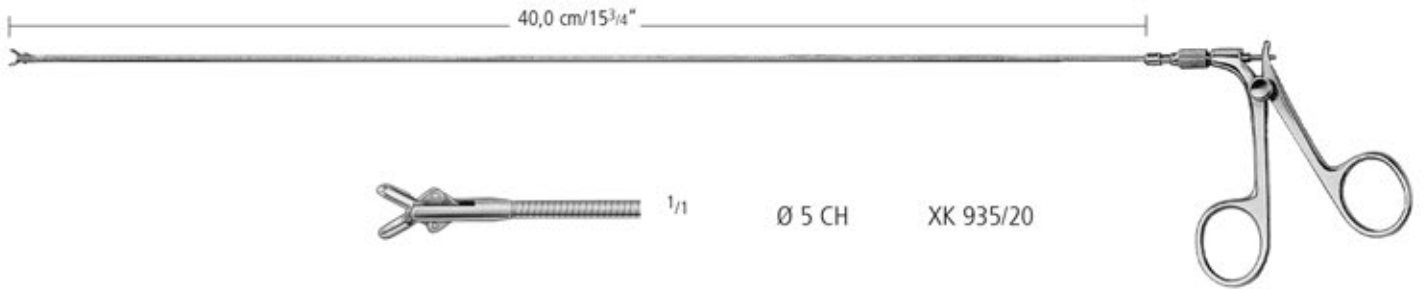

1/1 Ø 5 CH XK 935/20

1/1 Ø 5 CH XK 936/20

1/1 Ø 5 CH XK 937/20

>> Resektoskop mit Dauerspülschaft, drehbar
>> Resectoscope with continuous flow shaft, rotating

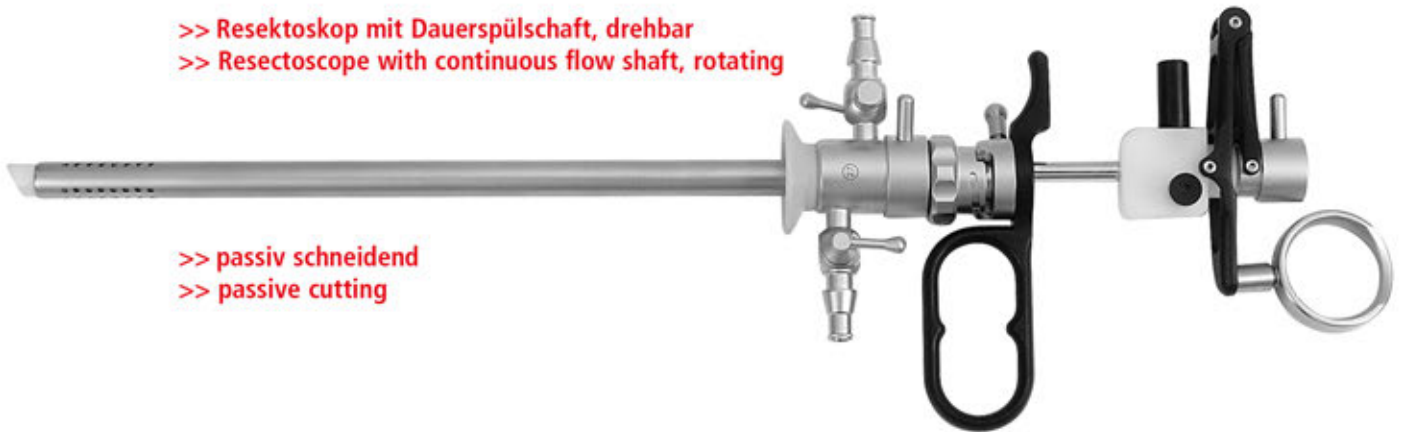

>> passiv schneidend
>> passive cutting

Ø 27 CH XM 500/00
komplett
complete
completo
complet
completo

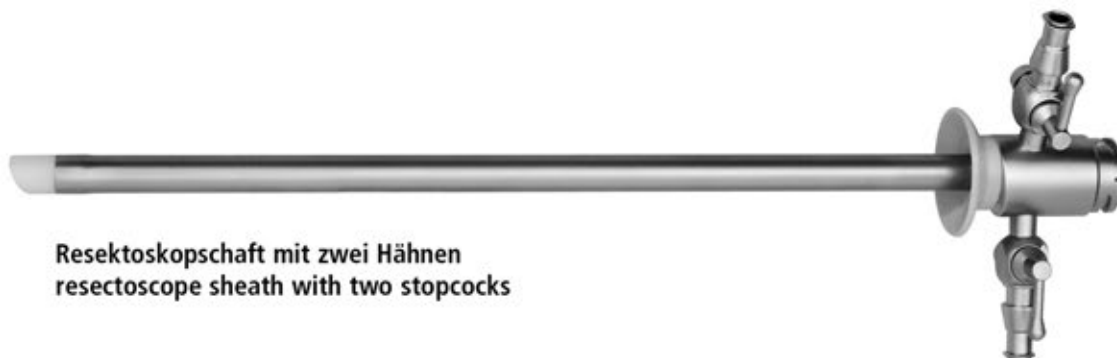

Resektoskopschaft mit zwei Hähnen
resectoscope sheath with two stopcocks

Ø 24 CH XM 501/25

ZS 981/04

URO

ZS 981/02 ZS 981/01 ZS 145/05

ZS 140/00 ZS 140/05 ZS 140/10 ZS 140/25 ZS 140/30 ZS 140/35 ZS 140/40 ZS 140/45 ZS 140/55

Ø 24 CH Schneide- und Koagulationselektroden
 Ø 24 CH Cutting and coagulation electrodes

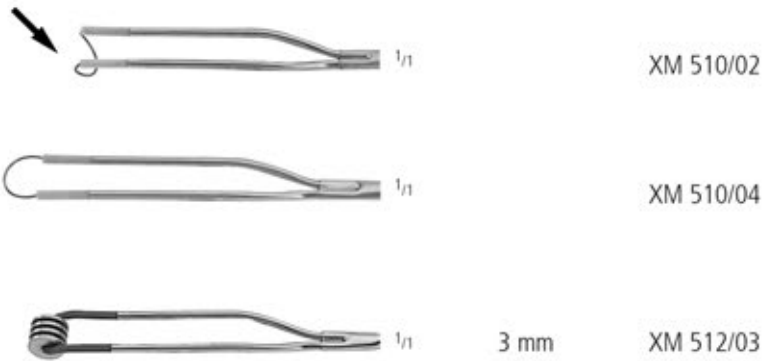

Universal 0° / 30° for endoscopes Ø 4,0 mm Ø 8 mm XP 800/07



Dauerspülschaft Continuous flow sheath for endoscopes Ø 4,0 mm Ø 8 mm / 30° XP 803/83

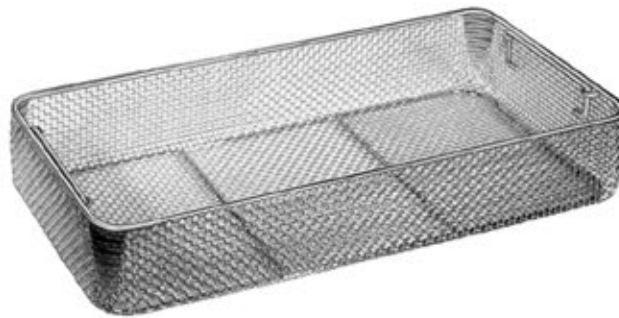

L(mm)	B(mm)	H(mm)	
540	255	50	SK 307/05



L(mm)	B(mm)	H(mm)	
460	80	52	SU 515/46

NEPHRECTOMY

URO

SET

ZS 145/05

Siebvorschlag - Suggested instrument set



ZS 145/05 NEPHRECTOMY SET

Contents:		Qty
AA 201/16	ROCHESTER-PEAN FCPS CVD 16,0 CM	12
AA 201/20	ROCHESTER-PEAN FCPS CVD 20,0 CM	4
AA 210/16	OCHSNER-KOCHER ART-FCPS.STR 16,0 CM	4
AA 345/19	MIXTER FORCEPS CVD 19,0 CM	2
AA 401/23	LAHEY GALL DUCT CLAMP 23,0 CM	2
AA 409/24	GUYON KIDNEY PEDICLE CLAMP FCPS 24,0 CM	2
AA 417/23	HERRICK KIDNEY PEDICLE CLAMP FCPS 23,0 CM	2
AA 529/21	WERTHEIM-CULLEN CLAMP-FORCEPS 21,5 CM	2
AA 751/13	BACKHAUS TOWEL FORCEPS 13,0 CM	6
AB 050/25	STANDARD DRESSING FORCEPS STR 25,0 CM	2
AB 060/25	STANDARD TISSUE FCPS. 1X2 T STR 25,0 CM	2
AB 200/25	POTTS-SMITH DRESSING FORCEPS STR 25,0 CM	2
AB 210/25	POTTS-SMITH TISS.FCPS STR 1X2 T. 25,0 CM	2
AC 070/23	MAYO OPER. SCS. STR BL/BL 23,0 CM	1
AC 071/23	MAYO OPER. SCS. CVD BL/BL 23,0 CM	1
AD 020/13	SCALPEL HANDLE NO. 3 L	1
AE 100/18	MAYO-HEGAR NEEDLE HOLDER 18,0 CM	1
AE 130/27	MASSON NEEDLE HOLDER 27,0 CM	1
AF 200/25	FOERSTER-BALLENGER STR SERRATED 25,0 CM	6
AK 247/04	RICHARDSON RETRACTOR 52X22 MM 24,0 CM	2
AK 247/05	RICHARDSON RETRACTOR 65X50 MM 24,0 CM	2
KA 681/17	DOYEN PERIOST.RASPATORY CVD LEFT 17,0 CM	1
KA 683/17	DOYEN PERIOST.RASPATORY CVD RIGHT 17,0 CM	1
KA 689/20	ALEXANDER RASPATORIES 20,0 CM	1
KA 762/19	SEMB BONE HOLDING FCPS W.RATCHET 19,0 CM	1
KA 853/22	STILLE-LUER BONE RONGEURS CVD. 22,0 CM	1
KA 892/27	LISTON-KEY(TUDOR-EDWARDS)BONE CUTT. FCPS	1
KD 055/25	ALLIS FCPS 5X6T 25,0 CM	4
KD 111/20	BABCOCK TISSUE FCPS 20,0 CM	4
SK 305/07	WIRE BASKET, 485 X 255 X 50 MM	1

Sterilization Container KYE 200/51, if required

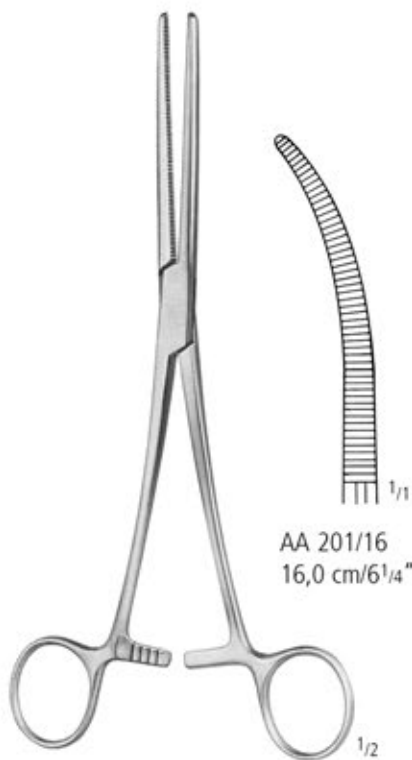

AA 201/16
16,0 cm/6¹/₄"

ROCHESTER-PEAN

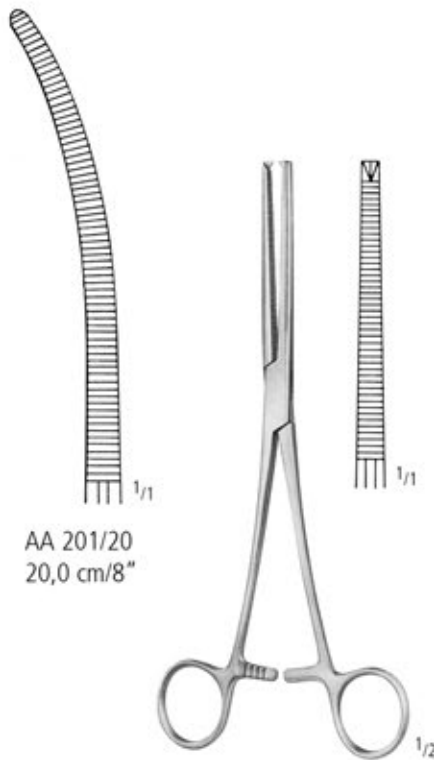

AA 201/20
20,0 cm/8"

OCHSNER-KOCHER 1:2

AA 210/16
16,0 cm/6¹/₄"

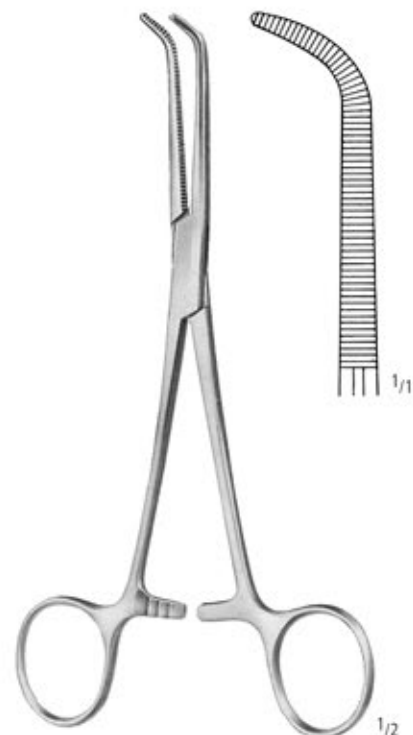

MIXTER
AA 345/19
19,0 cm/7¹/₂"

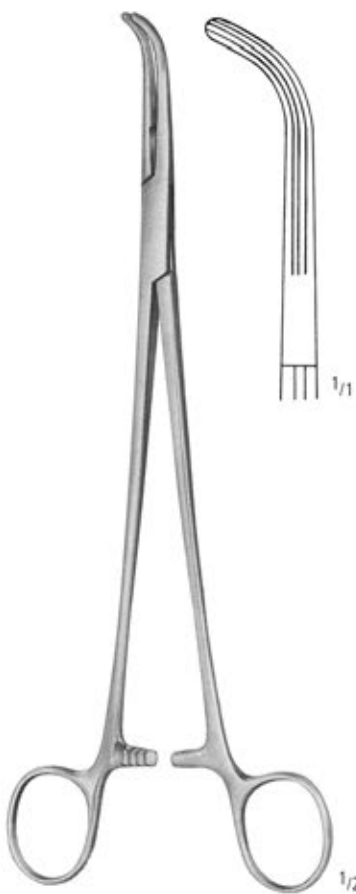

LAHEY
AA 401/23
23,0 cm/9"

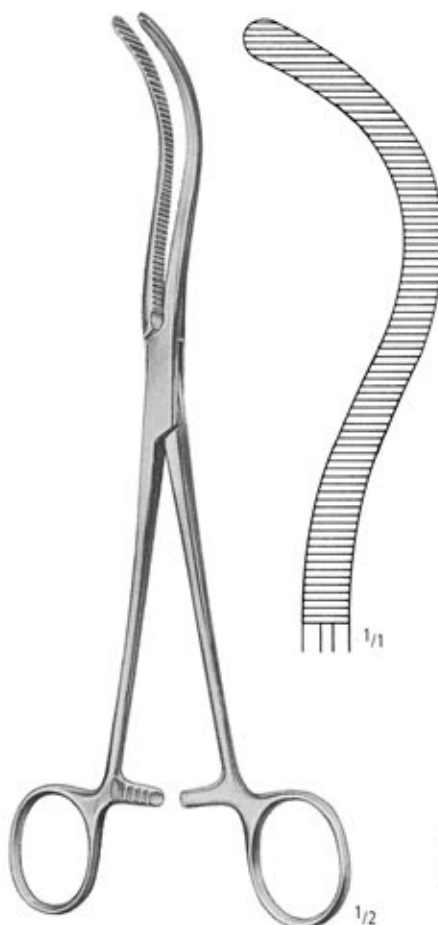

GUYON
AA 409/24
24,0 cm/9¹/₂"

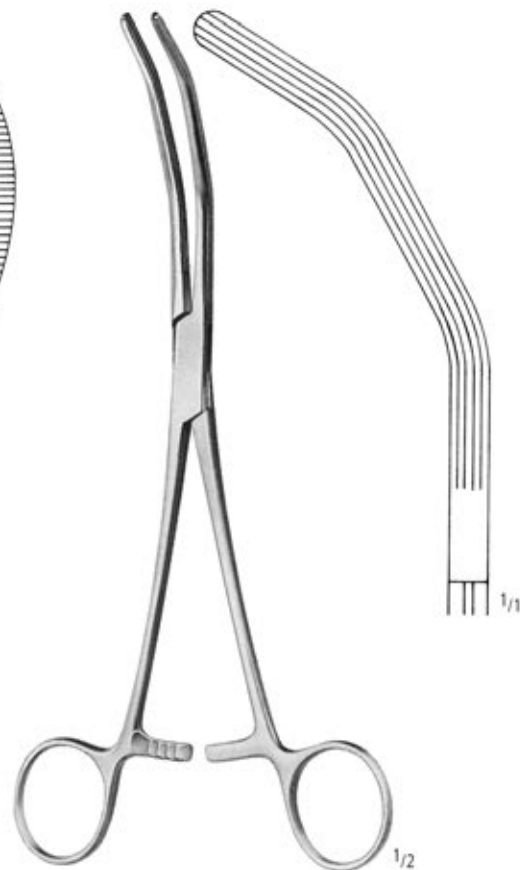

HERRICK
AA 417/23
23,0 cm/9"



WERTHEIM-CULLEN
AA 529/21
21,5 cm/8½"

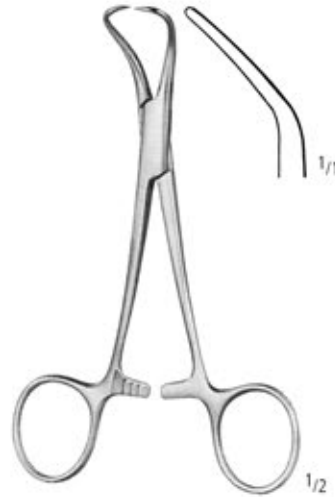

BACKHAUS
AA 751/13
13,0 cm/5"



STANDARD
AB 050/25
25,0 cm/10"

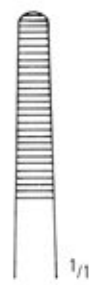

STANDARD 1:2
AB 060/25
25,0 cm/10"



POTTS-SMITH
AB 200/25
25,0 cm/10"



POTTS-SMITH 1:2
AB 210/25
25,0 cm/10"



MAYO
AC 070/23
23,0 cm/9"



MAYO
AC 071/23
23,0 cm/9"



AD 020/13
No. 3L



MAYO-HEGAR
AE 100/18
18,0 cm/7"





MASSON
AE 130/27
27,0 cm/10³/₄"

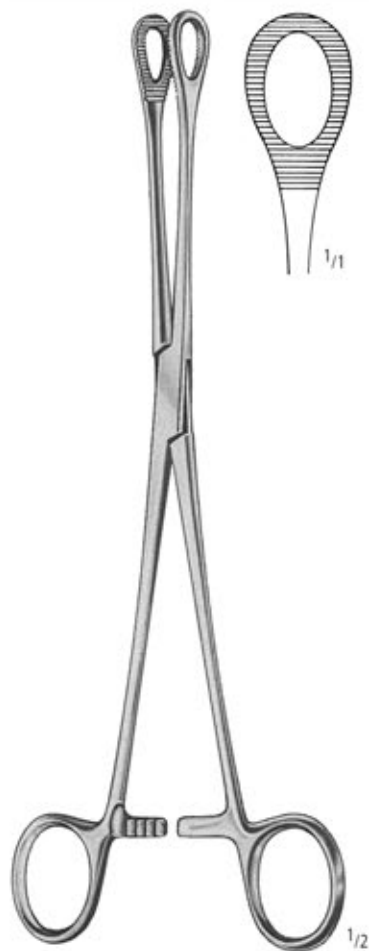

FOERSTER-BALLEGER
AF 200/25
25,0 cm/10"

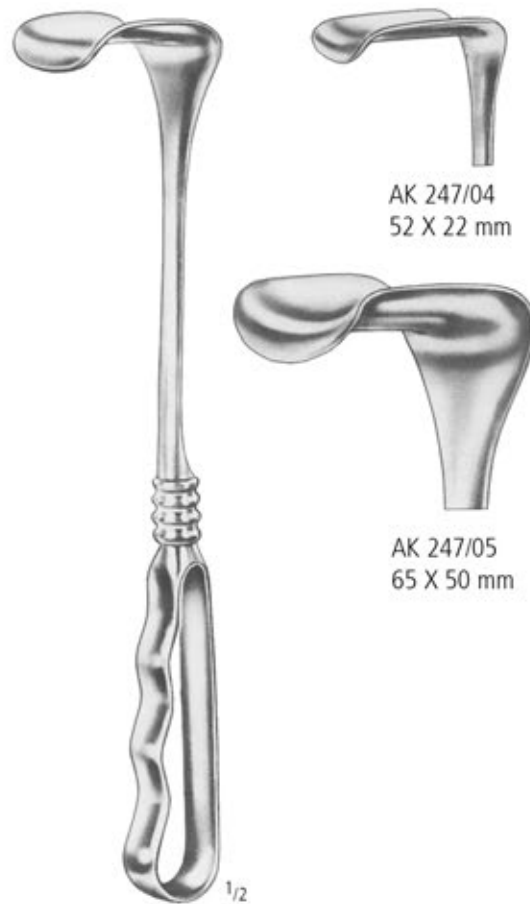

RICHARDSON (KELLY)
24,0 cm/9¹/₂"



DOYEN
17,0 cm/6³/₄"



ALEXANDER
KA 689/20
20,0 cm/8"

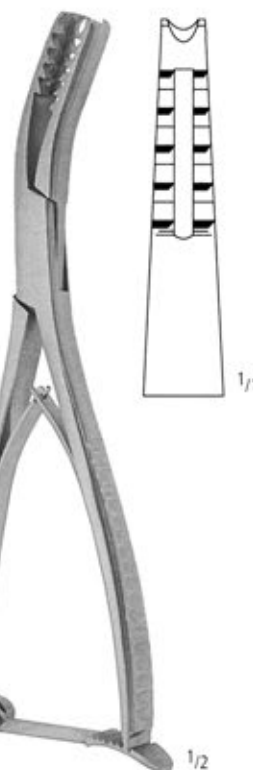

SEMB
KA 762/19
19,0 cm/7¹/₂"



STILLE-LUER
KA 853/22
22,0 cm/8³/₄"



**LISTON-KEY
(TUDOR-EDWARDS)**
KA 892/27
27,0 cm/10¹/₂"

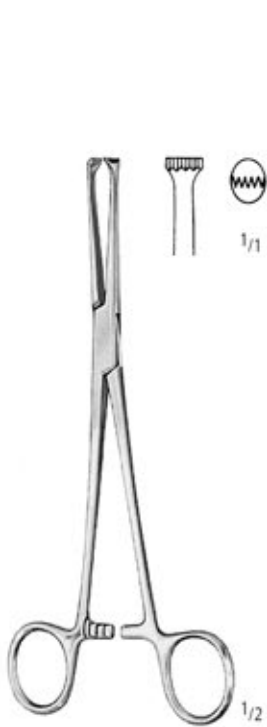

ALLIS 5:6
KD 055/25
25,0 cm/10"

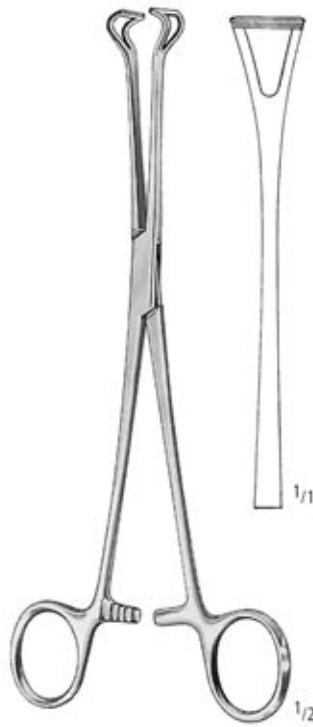

BABCOCK
KD 111/20
20,0 cm/8"

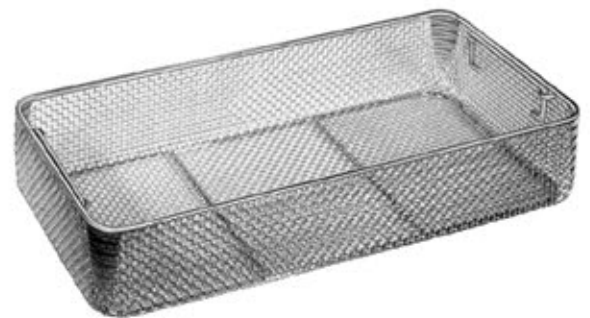

L(mm)	B(mm)	H(mm)	
485	255	70	SK 305/07

RESECTOSCOPY BASIC

Endoscopy

URO

SET ZS 981/01

Siebvorschlag - Suggested instrument set



ZS 981/01 RESECTOSCOPY BASIC SET

Contents:		Qty
XM 500/00	WORKING UNIT, COMPLETE, PASSIVE ROTATABLE	1
XM 500/11	WORKING ELEMENT, ONLY, ACTIVE VERSION	1
XM 502/01	DEFLECTING OBTURATOR, Ø 24 CH	1
XM 502/02	VISUAL OBTURATOR, Ø 24 CH	1
XM 510/01	ELECTRODE KNIFE	1
XM 510/02	ELECTRODE LOOP 30°	1
XM 512/02	ELECTRODE BALL, Ø 3,0 MM	1
XP 720/40	TELESCOPE, Ø 4,0 MM, 0°	1
XP 720/43	TELESCOPE, Ø 4,0 MM, 30°	1
XP 880/00	ELLIK EVACUATOR COMPLETE	1
XR 824/13	CONNECTION CABLE STORZ/ERBE, 300,0 CM	1
SK 307/05	WIRE BASKET, 540 x 255 x 50 MM	1
SU 515/46	WIRE BASKET, 460 x 80 x 52 MM	1

Sterilizing Container KYE 200/51, if required.

Optional additional Equipment to Basic Set:

XT 035/23	BASIC FIBRE OPTIC CABLE, Ø 3,5 MM, DIAM., 230,0 CM	1
XT 100/01	ADAPTER PROJECTOR SIDE, STORZ	1
XT 100/11	ADAPTER ENDOSCOPE SIDE, STORZ	1
XT 170/00	COLD LIGHT SOURCES, 110-230 VAC/50/60 HZ	1
XT 302/00	NOPACAM CAMERA, PAL, C-MOUNT WITH TV ADAPTOR, 21,0 MM	1
XT 400/19	LCD MONITOR 19", ANALOG (D-SUB), DVI-D, S-VIDEO, AV COMP, AC 100 - 240 V	1
XU 174/00	UROLOGY PUMP, COMPLETE	1
XU 800/40	NOPAMOBIL 100, CLOSED	1

For further details/pictures see page 498 ff.

>> Resektoskop mit Dauerspülschaft, drehbar
>> Resectoscope with continuous flow shaft, rotating

>> aktiv schneidend
>> active cutting

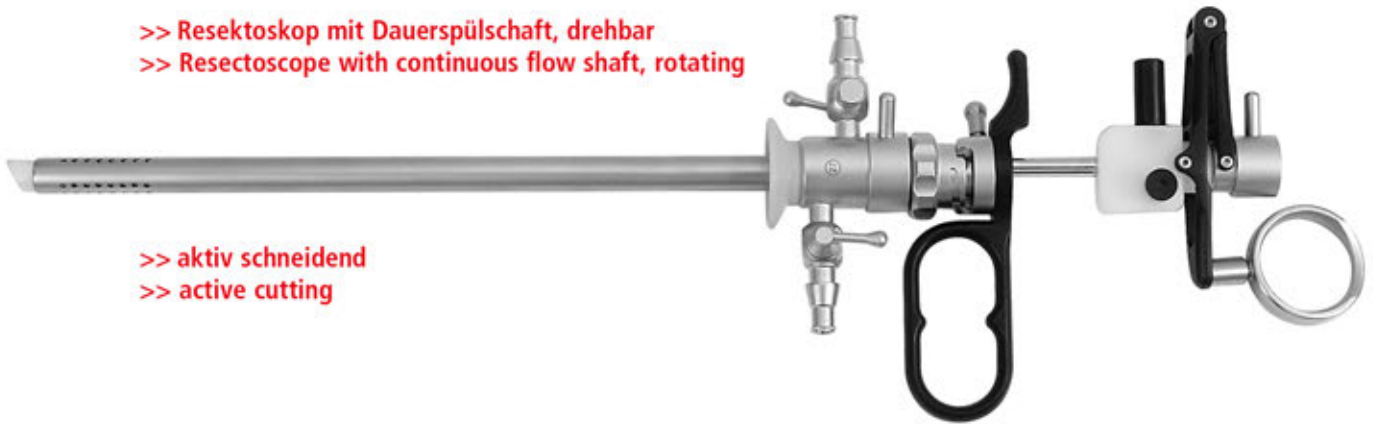

XM 500/11
Arbeitselement, allein
Working element, only

Ø 27 CH XM 500/00
komplett
complete
completo
complet
completo



Krümmbarer Obturator
deflecting obturator

Ø 24 CH XM 502/01



Sichtobturator
visual obturator

Ø 24 CH XM 502/02



XM 510/01



XM 510/02



3 mm XM 512/02

ZS 140/00 ZS 140/05 ZS 140/10 ZS 140/25 ZS 140/30 ZS 140/35 ZS 140/40 ZS 140/45 ZS 140/55 ZS 981/04 ZS 140/55 ZS 140/55 ZS 140/55 ZS 145/05

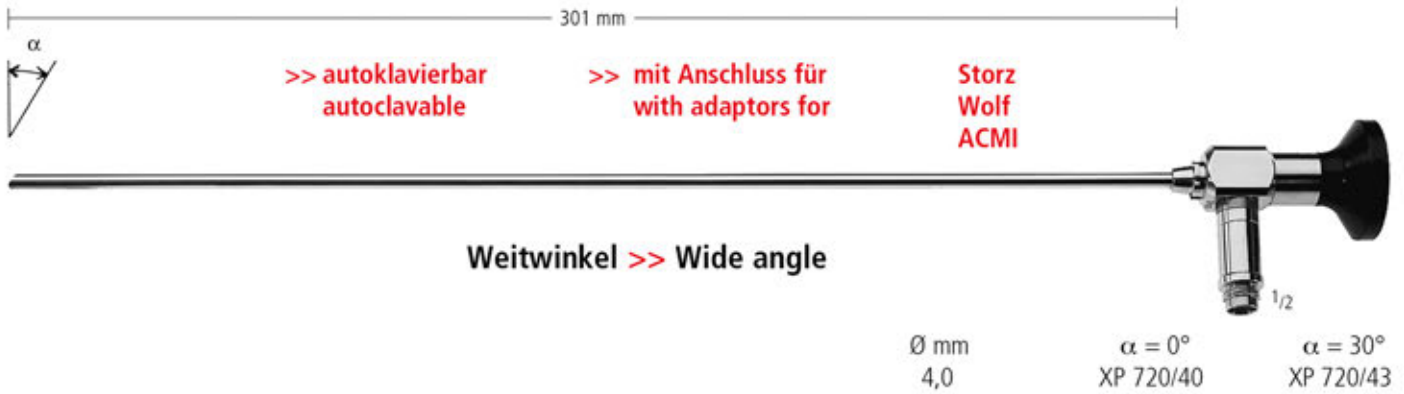

ELLIK Evakuator
 XP 880/00
 komplett
 complete
 completo
 complet
 completo



STORZ / ERBE
 300 cm XR 824/13

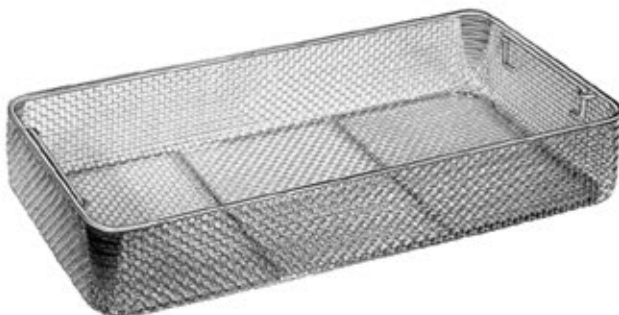

L(mm) B(mm) H(mm)
 540 255 50 SK 307/05



L(mm) B(mm) H(mm)
 460 80 52 SU 515/46

CYSTOSCOPY BASIC

Endoscopy

URO

SET ZS 981/02

Siebvorschlag - Suggested instrument set



ZS 981/02 CYSTOSCOPY BASIC SET

Contents:		Qty
XK 935/20	GRASPING FORCEPS, 5 CH.	1
XK 936/20	GRASPING FORCEPS, 5 CH.	1
XK 937/20	GRASPING FORCEPS, 5 CH.	1
XP 830/19	CYSTOSCOPY SHEATH, 19 CH.	1
XP 830/23	CYSTOSCOPY SHEATH, 23 CH.	1
XP 840/02	ALBARRAN DOUBLE	1
XP 845/02	OPTIC BRIDGE 2 CHANNEL	1
XP 850/35	ELECTRODE 5 CH.	1
XP 850/45	ELECTRODE 5 CH.	1
XP 850/57	ELECTRODE 7 CH.	1
XP 850/64	STONE BASKET, 4 WIRES	1
XP 850/80	HANDLE	1
XP 720/43	TELESCOPE, Ø 4,0 MM, 30°	1
SK 307/05	WIRE BASKET, 540 x 255 x 50 MM	1
SU 515/46	WIRE BASKET, 460 x 80 x 52 MM	1

Sterilizing Container KYE 200/51, if required.

Optional additional Equipment to Basic Set see:

XT 035/23	BASIC FIBRE OPTIC CABLE, Ø 3,5 MM, DIAM., 230,0 CM	1
XT 100/01	ADAPTER PROJECTOR SIDE, STORZ	1
XT 100/11	ADAPTER ENDOSCOPE SIDE, STORZ	1
XT 170/00	COLD LIGHT SOURCES, 110-230 VAC/50/60 HZ	1
XT 302/00	NOPACAM CAMERA, PAL, C-MOUNT WITH TV ADAPTOR, 21,0 MM	1
XT 400/19	LCD MONITOR 19", ANALOG (D-SUB), DVI-D, S-VIDEO, AV COMP, AC 100 - 240 V	1
XU 174/00	UROLOGY PUMP, COMPLETE	1
XU 800/40	NOPAMOBIL 100, CLOSED	1

For further details/pictures see page 498 ff.

ZS 981/02 CYSTOSCOPY BASIC SET

GYN

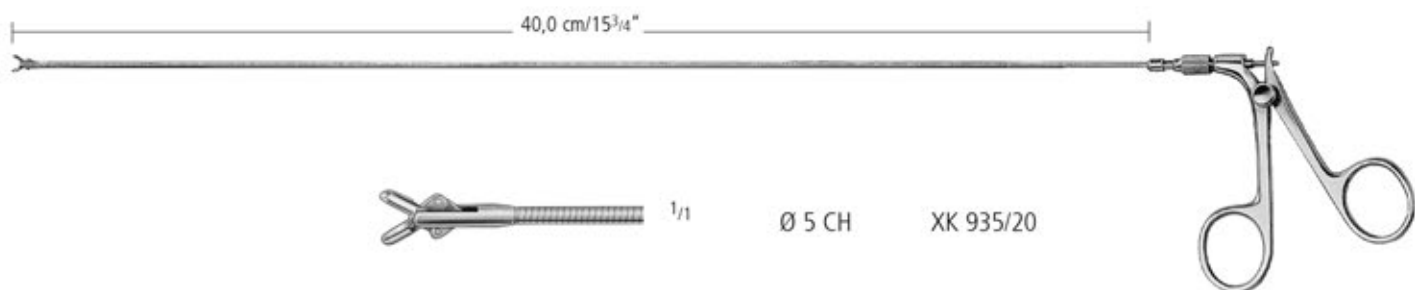

 1/1 Ø 5 CH XK 935/20

 1/1 Ø 5 CH XK 936/20

 1/1 Ø 5 CH XK 937/20

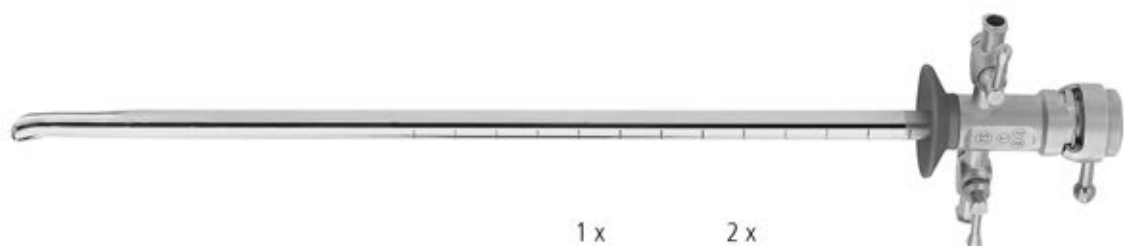

		1 x	2 x
XP 830/19	19 CH	5	4
XP 830/23	23 CH	9	6

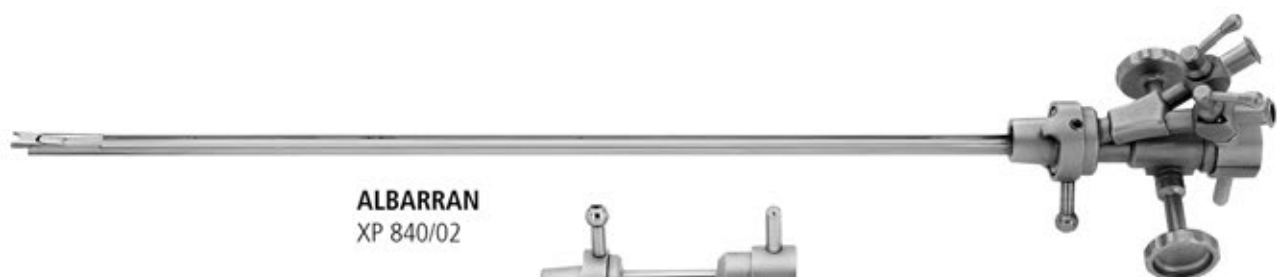

ALBARRAN
XP 840/02



XP 845/02



 Ø 5 CH XP 850/35

 Ø 5 CH XP 850/45

 Ø 7 CH XP 850/57

URO

ZS 981/01 ZS 145/05

ZS 981/02

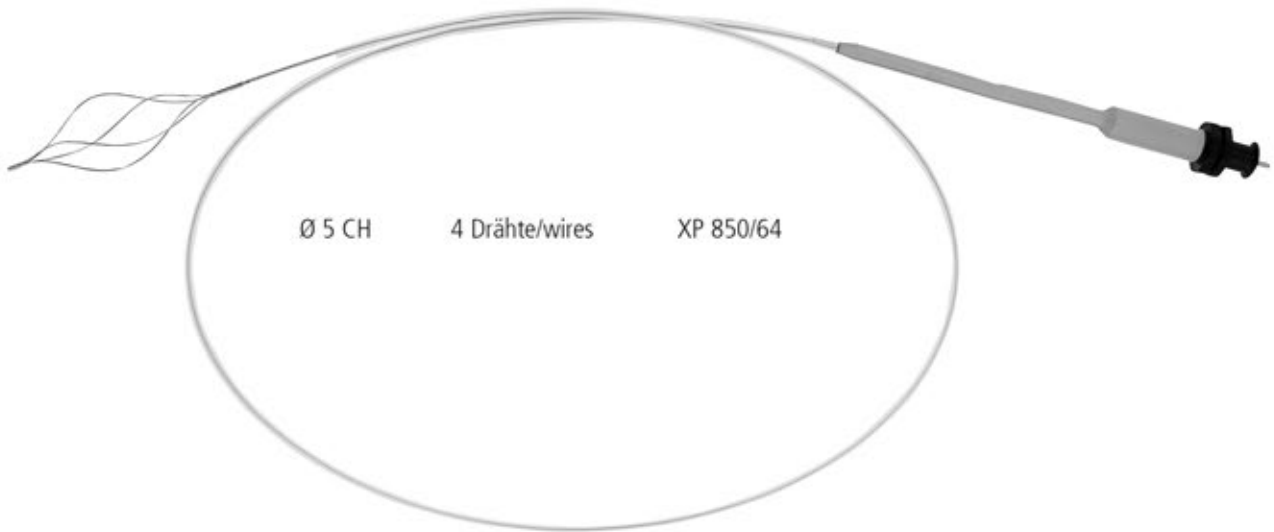

Ø 5 CH 4 Drähte/wires XP 850/64



XP 850/80

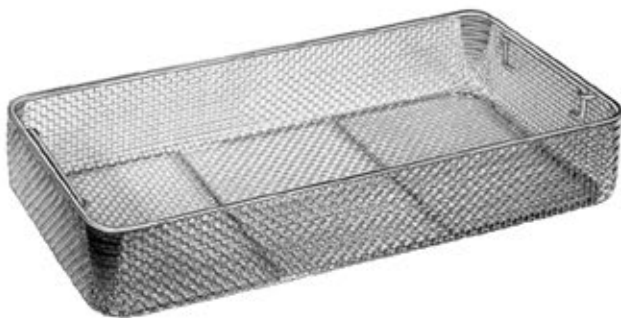
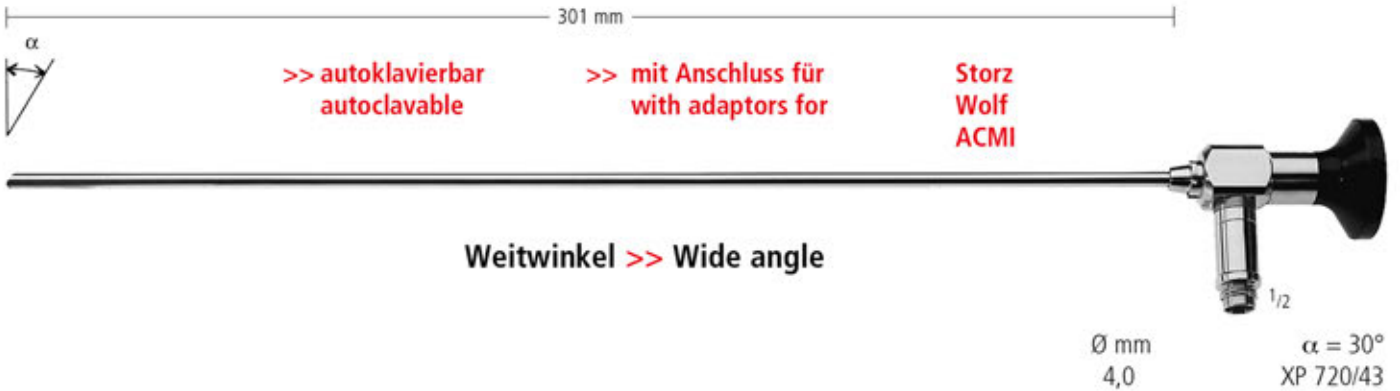

L(mm)	B(mm)	H(mm)	
540	255	50	SK 307/05



L(mm)	B(mm)	H(mm)	
460	80	52	SU 515/46

KLEMMEN
HEMOSTATS
PINZAS HEMOSTATICAS
PINCES HEMOSTATIQUES
PINZE EMOSTATICHE

AA

nopa[®] instruments

Weitere Klemmen finden Sie in unserem Katalog „Allgemeines Instrumentarium“ in Gruppe AA.

For further hemostats kindly refer to our catalogue „General Instruments“, section AA.

Para pinzas hemostaticas adicionales, por favor consulte nuestro catálogo de „Instrumental de uso general“, grupo AA.

Pour des pinces hemostatiques supplémentaires, consultez notre catalogue „Instrumentation Generale“, section AA.

Per gli altri pinze emostatiche, consultare il nostro catalogo „Strumentazione Generale“, gruppo AA.



AA KLEMMEN HEMOSTATS PINZAS HEMOSTATICAS PINCES HEMOSTATIQUES PINZE EMOSTATICHE

Arterienklemmen
 Artery Forceps
 Pinzas hemostáticas
 Pincas hémostatiques
 Pinze emostatiche



SPENCER-WELLS

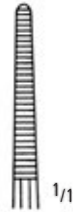

AA 110/13
13,0 cm/5"

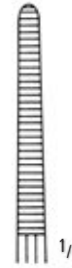

AA 110/14
14,0 cm/5 1/2"

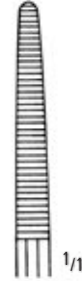

AA 110/15
15,5 cm/6"

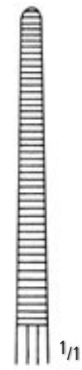

AA 110/18
18,0 cm/7"

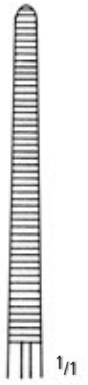

AA 110/20
20,0 cm/8"



AA 111/13
13,0 cm/5"



AA 111/14
14,0 cm/5 1/2"



AA 111/15
15,5 cm/6"

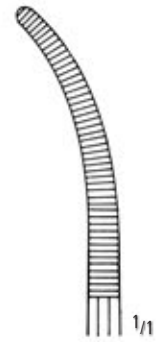

AA 111/18
18,0 cm/7"



AA 111/20
20,0 cm/8"

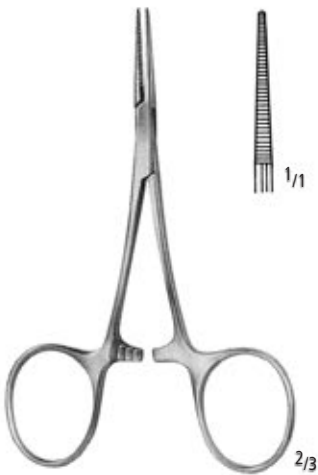

HARTMANN
 AA 114/10
 10,0 cm/4"

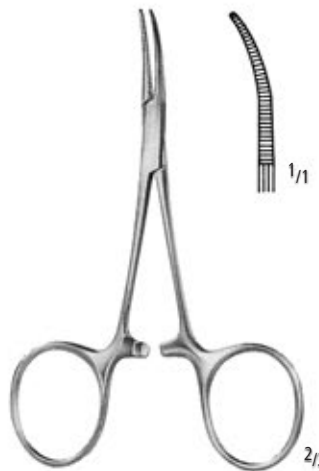

HARTMANN
 AA 115/10
 10,0 cm/4"

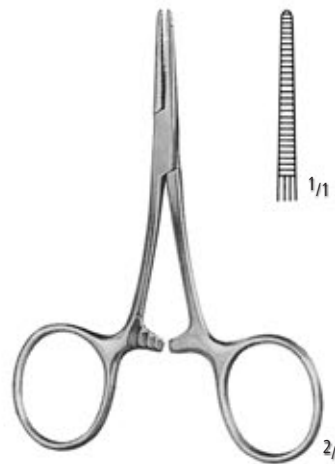

CARREL
 AA 116/08
 8,5 cm/3 1/2"

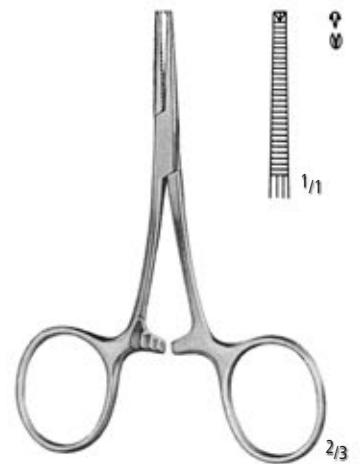

TERRIER 1:2
 AA 118/08
 8,5 cm/3 1/2"

Feine Arterienklemmen
 Fine Artery Forceps
 Pinzas hemostáticas finas
 Pincas hémostatiques fines
 Pinze emostatiche fine

AA

AB

AC

AD

AE

AF

AK

AL

AO

AP

AR

KB

KI

KC

KU

KYE

X

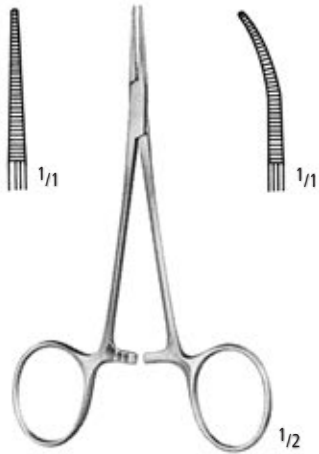

MICRO-MOSQUITO

AA 130/10 AA 131/10
 AA 130/12 AA 131/12

10,0 cm/4"
 12,0 cm/4³/₄"

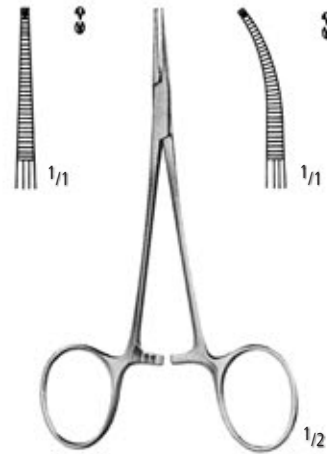

MICRO-MOSQUITO 1:2

AA 132/10 AA 133/10
 AA 132/12 AA 133/12

WILLIAM STEWART HALSTED

was professor of surgery in the Johns Hopkins University. In 1890 he had bronze casts made of his own hands. On these casts the first surgical rubber gloves were moulded.

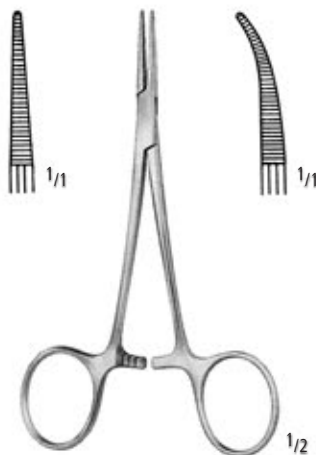

HALSTED-MOSQUITO

AA 150/12 AA 151/12
 AA 150/14 AA 151/14

12,5 cm/5"
 14,0 cm/5¹/₂"

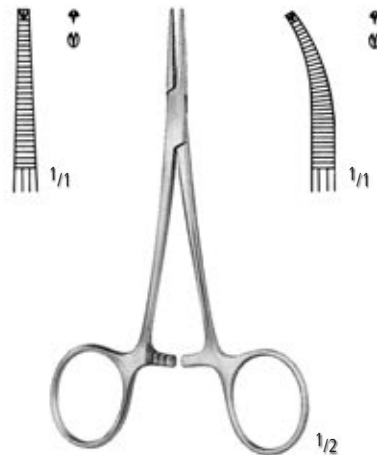

HALSTED-MOSQUITO 1:2

AA 152/12 AA 153/12
 AA 152/14 AA 153/14

AA KLEMMEN HEMOSTATS PINZAS HEMOSTATICAS PINCES HEMOSTATIQUES PINZE EMOSTATICHE

Arterienklemmen
 Artery Forceps
 Pinzas hemostáticas
 Pincas hémostatiques
 Pinze emostatiche

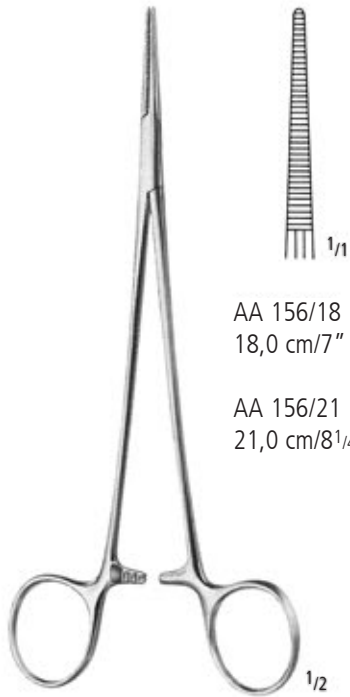

AA 156/18
 18,0 cm/7"

AA 156/21
 21,0 cm/8 1/4"

HALSTED



AA 157/18
 18,0 cm/7"

AA 157/21
 21,0 cm/8 1/4"

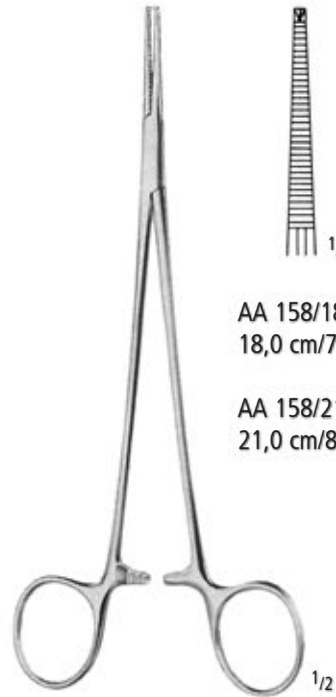

AA 158/18
 18,0 cm/7"

AA 158/21
 21,0 cm/8 1/4"

HALSTED 1:2



AA 159/18
 18,0 cm/7"

AA 159/21
 21,0 cm/8 1/4"

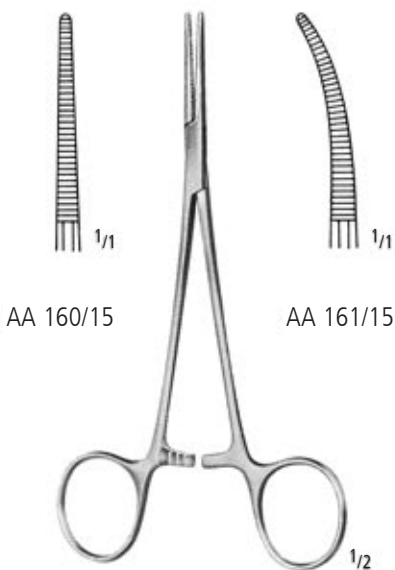

AA 160/15

AA 161/15

LERICHE
 15,0 cm/6"

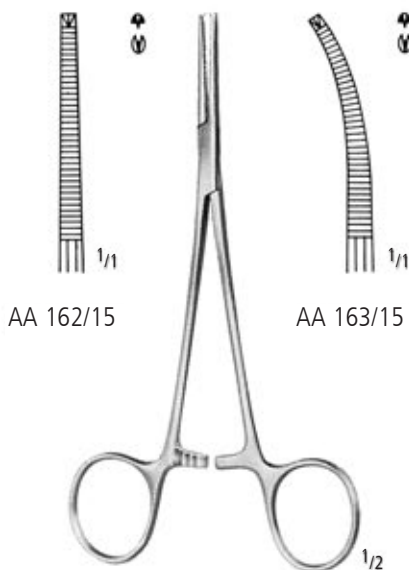

AA 162/15

AA 163/15

LERICHE 1:2
 15,0 cm/6"

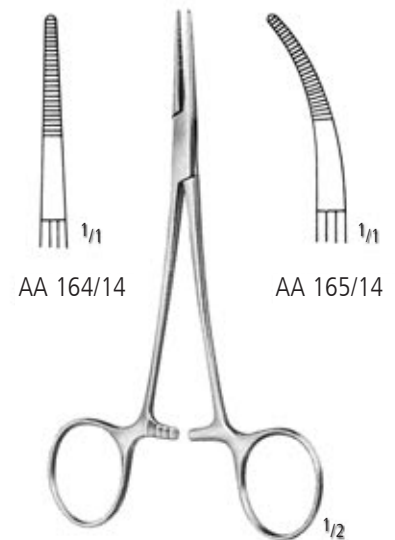

AA 164/14

AA 165/14

PROVIDENCE-HOSPITAL
 14,0 cm/5 1/2"

KLEMMEN HEMOSTATS PINZAS HEMOSTATICAS PINCES HEMOSTATIQUES PINZE EMOSTATICHE

Arterienklemmen
 Artery Forceps
 Pinzas hemostáticas
 Pincas hémostatiques
 Pinze emostatiche

AA

AB

AC

AD

AE

AF

AK

AL

AO

AP

AR

KB

KI

KC

KU

KYE

X

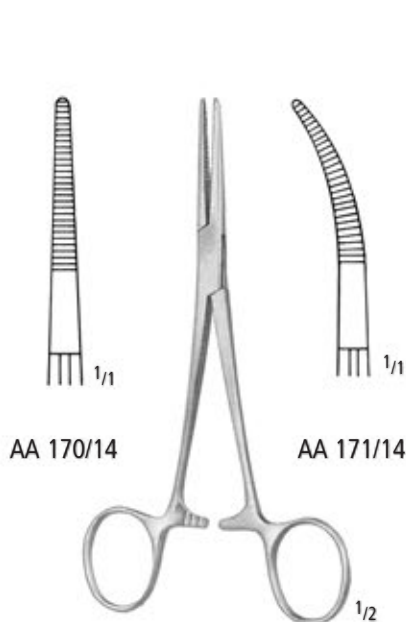

AA 170/14

AA 171/14

KELLY
 14,0 cm/5 1/2"

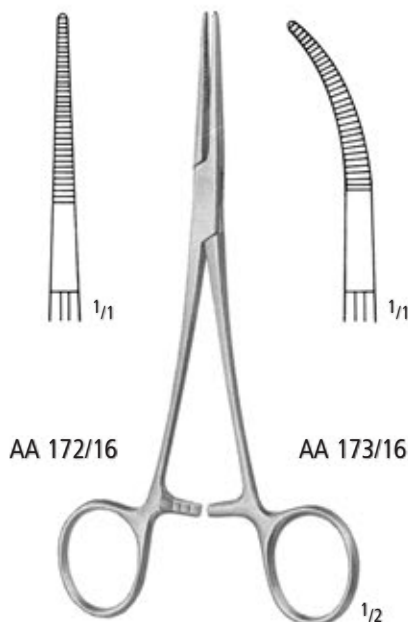

AA 172/16

AA 173/16

KELLY-RANKIN
 16,0 cm/6 1/4"

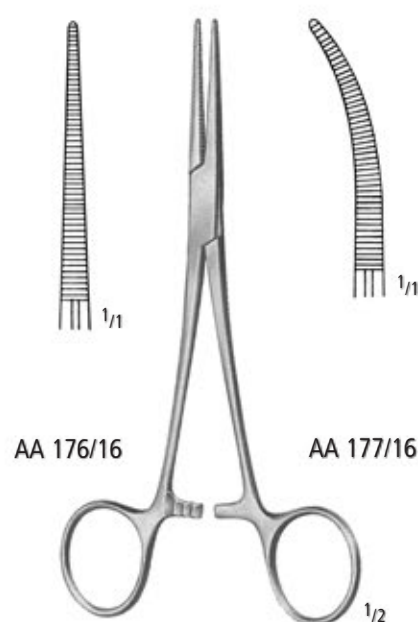

AA 176/16

AA 177/16

COLLER
 AA 176/14 14,0 cm/5 1/2" AA 177/14
 AA 176/16 16,0 cm/6 1/4" AA 177/16

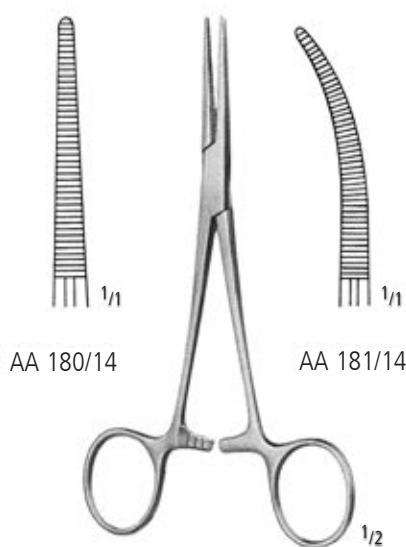

AA 180/14

AA 181/14

CRILE
 14,0 cm/5 1/2"

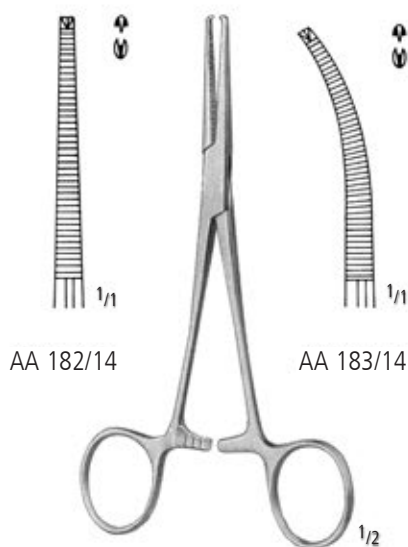

AA 182/14

AA 183/14

CRILE 1:2
 14,0 cm/5 1/2"

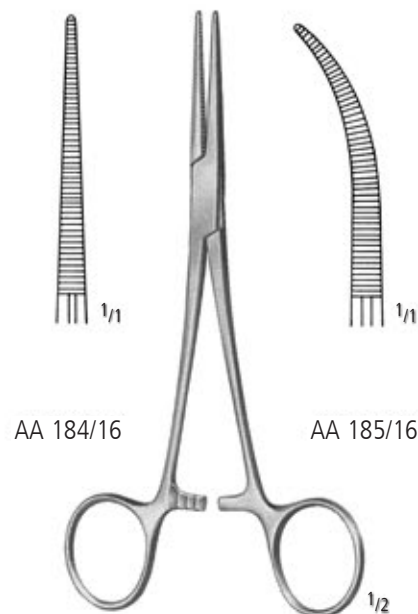

AA 184/16

AA 185/16

CRILE-RANKIN
 16,0 cm/6 1/4"

Arterienklemmen
 Artery Forceps
 Pinzas hemostáticas
 Pincas hémostatiques
 Pinze emostatiche

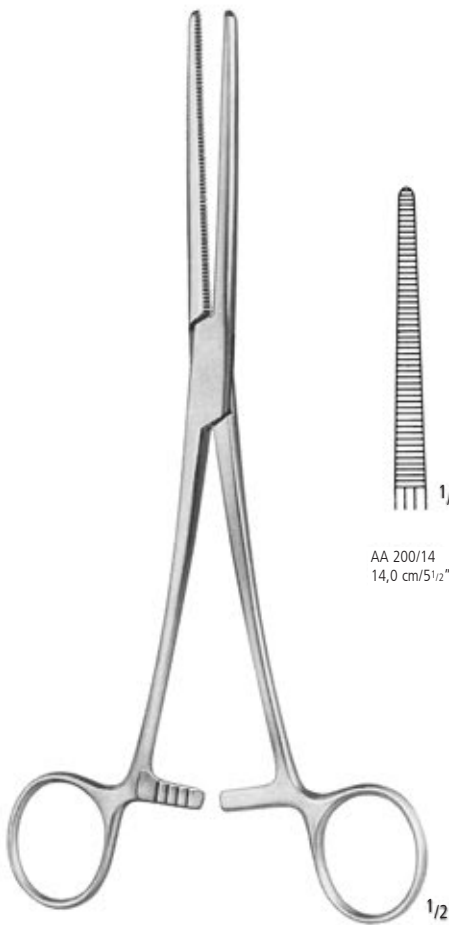

ROCHESTER-PEAN

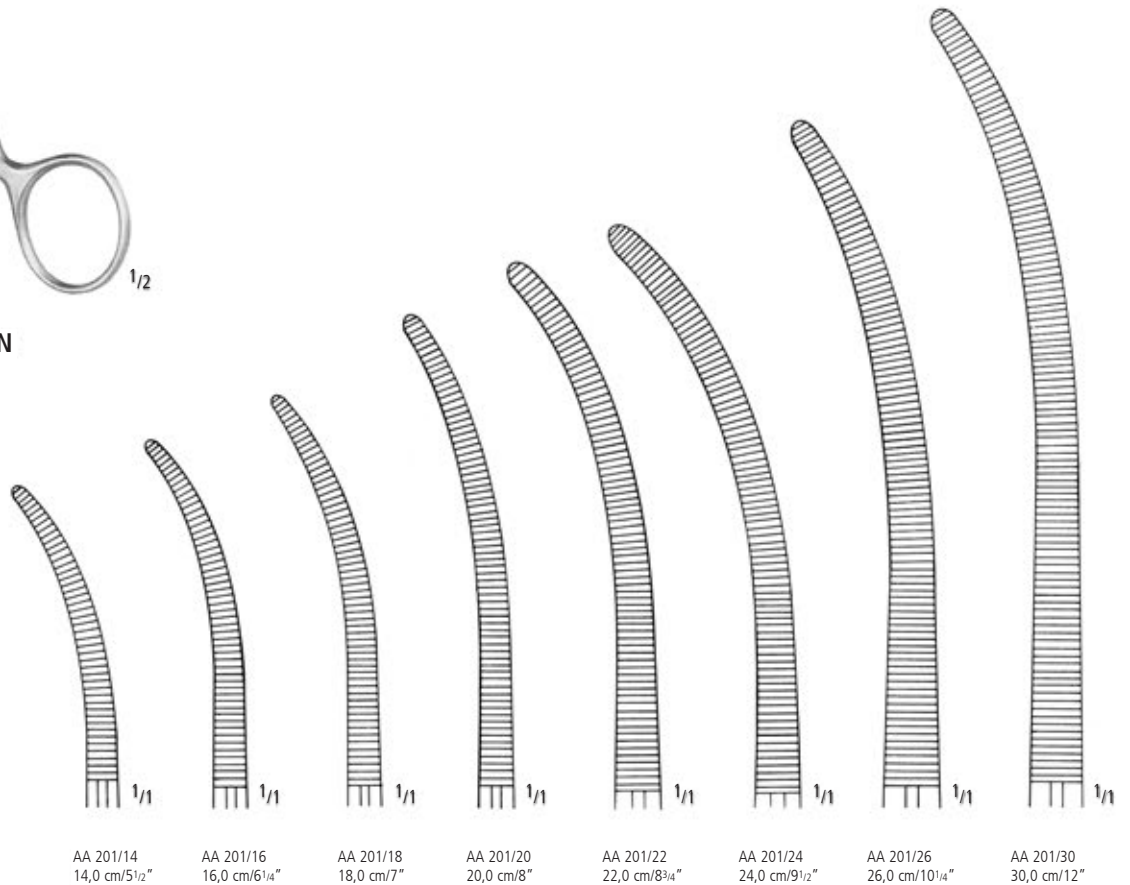
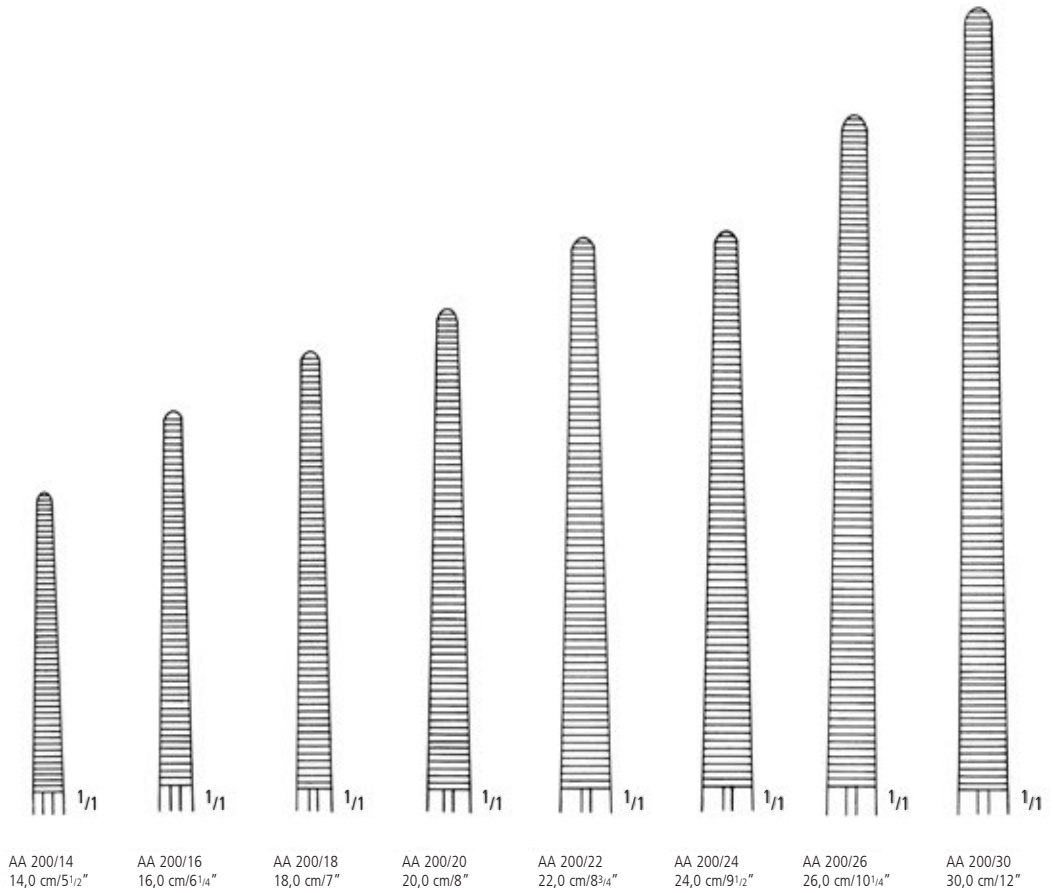

KLEMMEN HEMOSTATS PINZAS HEMOSTATICAS PINCES HEMOSTATIQUES PINZE EMOSTATICHE

Arterienklemmen
 Artery Forceps
 Pinzas hemostáticas
 Pincas hémostatiques
 Pinze emostatiche

AA

AB

AC

AD

AE

AF

AK

AL

AO

AP

AR

KB

KI

KC

KU

KYE

X

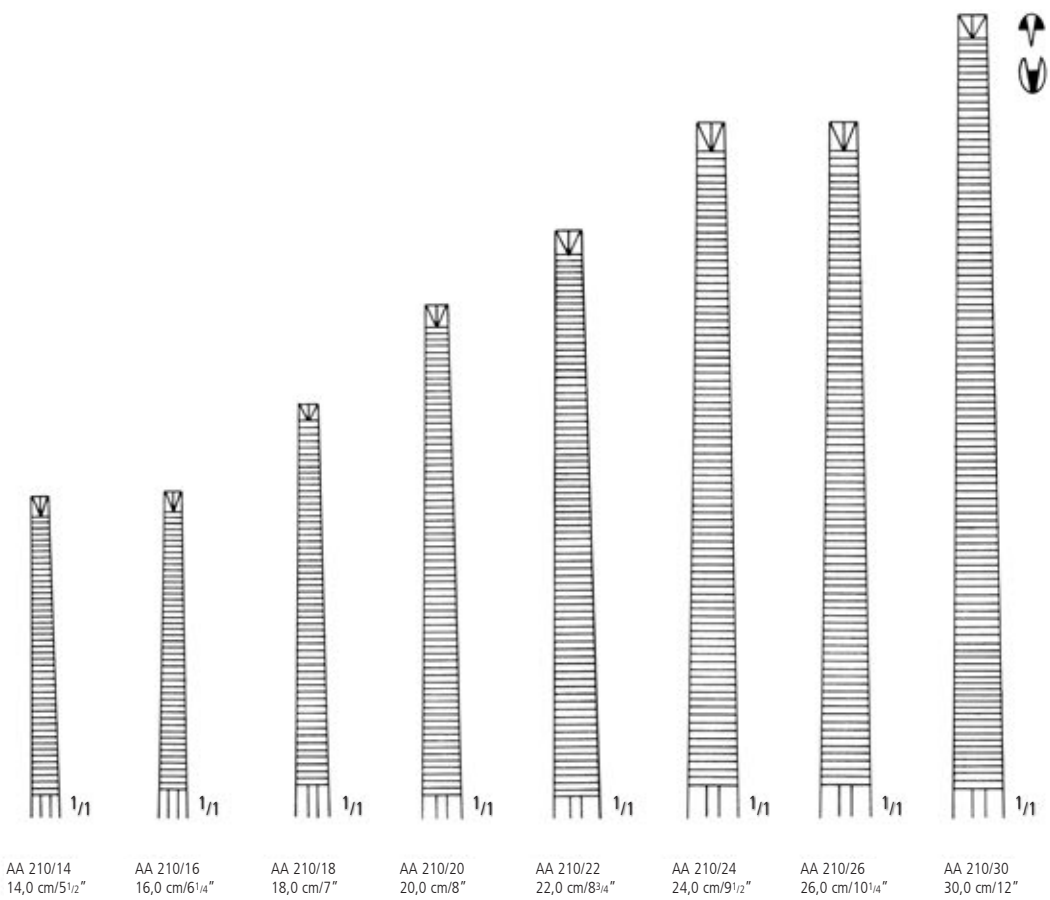
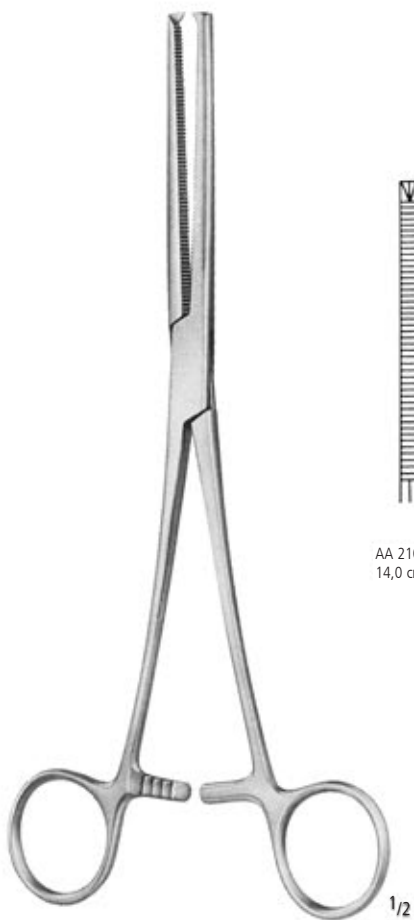

AA 210/14
14,0 cm/5 1/2"

AA 210/16
16,0 cm/6 1/4"

AA 210/18
18,0 cm/7"

AA 210/20
20,0 cm/8"

AA 210/22
22,0 cm/8 3/4"

AA 210/24
24,0 cm/9 1/2"

AA 210/26
26,0 cm/10 1/4"

AA 210/30
30,0 cm/12"

OCHSNER-KOCHER 1:2

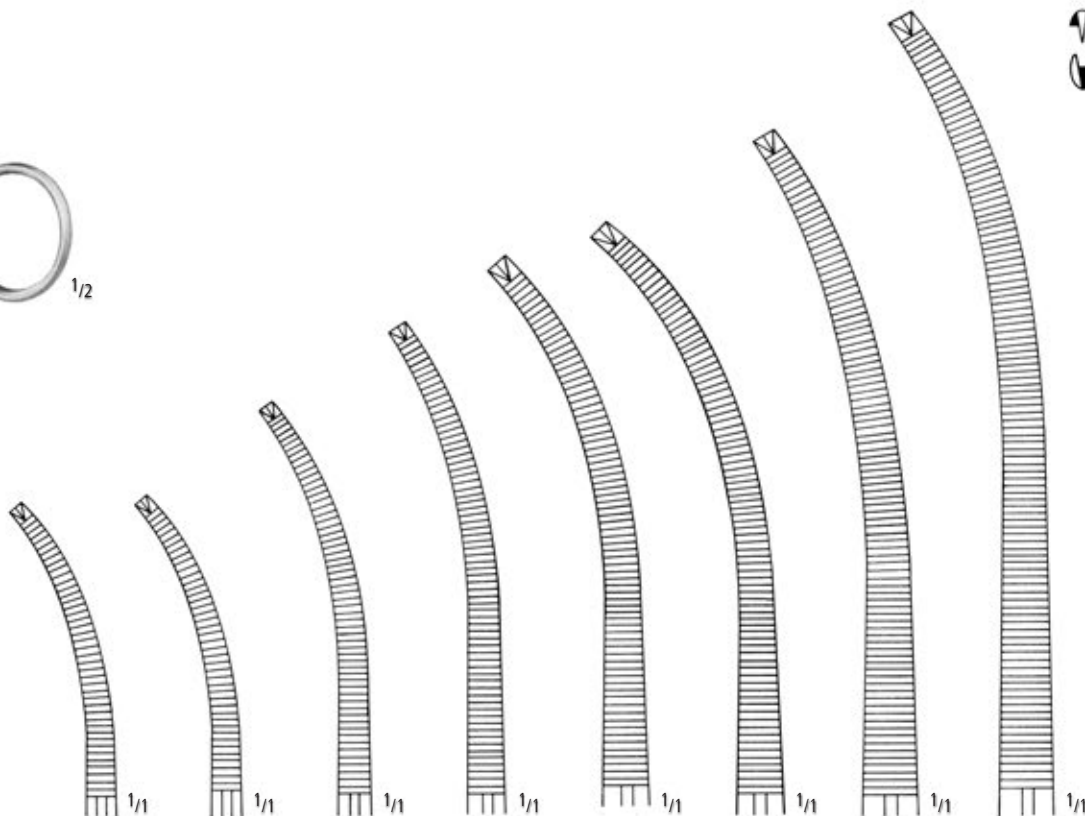

AA 211/14
14,0 cm/5 1/2"

AA 211/16
16,0 cm/6 1/4"

AA 211/18
18,0 cm/7"

AA 211/20
20,0 cm/8"

AA 211/22
22,0 cm/8 3/4"

AA 211/24
24,0 cm/9 1/2"

AA 211/26
26,0 cm/10 1/4"

AA 211/30
30,0 cm/12"

Grazile Arterienklemmen
 Delicate Artery Forceps
 Pinzas hemostáticas delgadas
 Pincas hémostatiques graciles
 Pinze emostatiche delicate

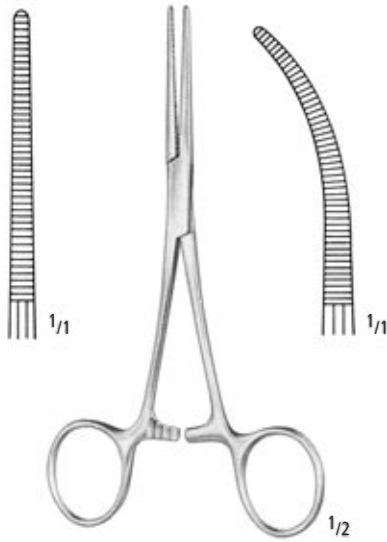

PEAN - DELICATE

AA 214/13	AA 215/13
AA 214/14	AA 215/14
AA 214/16	AA 215/16

13,0 cm/5"
 14,0 cm/5 1/2"
 16,0 cm/6 1/4"

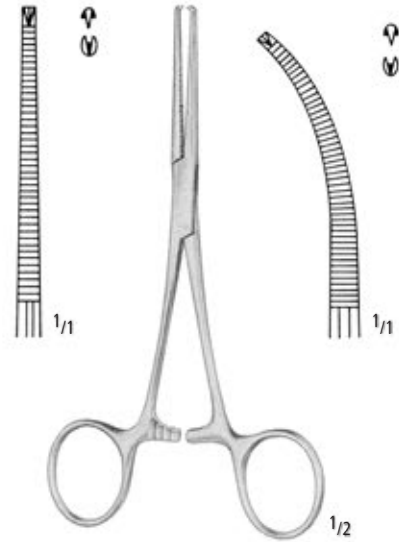

KOCHER 1:2 - DELICATE

AA 216/13	AA 217/13
AA 216/14	AA 217/14
AA 216/16	AA 217/16

JULES PEAN, born 1830, died 1898, was the most important French gynecological surgeon of his time. He studied at Paris 1860. 1864 Pean was the first surgeon in Paris to perform an ovariectomy. By the use of Pean pins he introduced forceps pressure for control of hemorrhage, thus he invented the most used surgical instrument, next to the scalpel.

ALBERT J. OCHSNER, born 1858, died 1925. He devoted much time to attending and participating in medical discussions and was member of all leading societies in his fields.

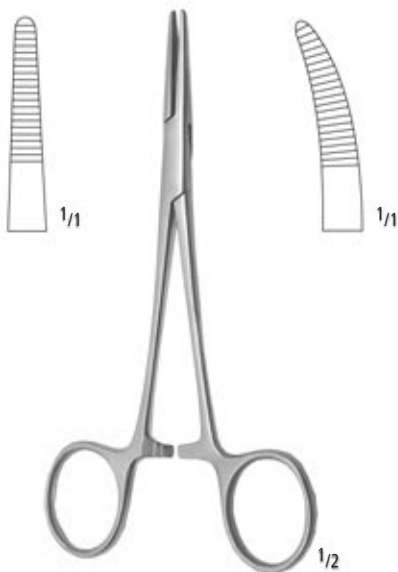

CAIRNS

AA 218/15	15,0 cm/6"	AA 219/15
-----------	------------	-----------



DUNHILL

AA 220/13
 13,0 cm/5"

Arterienklemmen, Präparier- und Ligaturklemmen
 Artery Forceps, Dissecting and Ligature Forceps
 Pinzas hemostáticas, Pinzas para preparaciones y ligaduras
 Pincas hémostatiques, Pincas à disséquer et à ligatures
 Pinze emostatiche, Pinze per preparazioni e legature

AA

AB

AC

AD

AE

AF

AK

AL

AO

AP

AR

KB

KI

KC

KU

KYE

X



OVERHOLT-GEISSENDOERFER

21,0 cm/8¹/₄"
 27,0 cm/10³/₄"

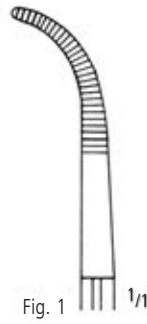

Fig. 1 1/1

AA 221/01
 AA 223/01



Fig. 2 1/1

AA 221/02
 AA 223/02

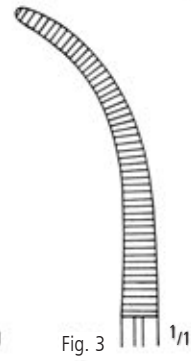

Fig. 3 1/1

AA 221/03
 AA 223/03

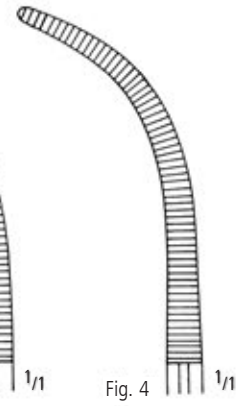

Fig. 4 1/1

AA 221/04
 AA 223/04

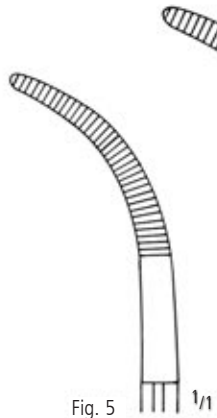

Fig. 5 1/1

AA 221/05
 AA 223/05

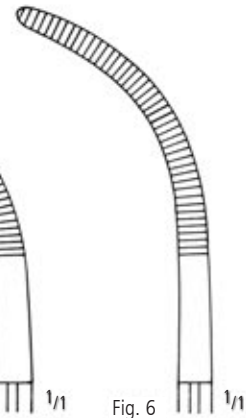

Fig. 6 1/1

AA 221/06
 AA 223/06



Fig. 7 1/1

AA 221/07
 AA 223/07

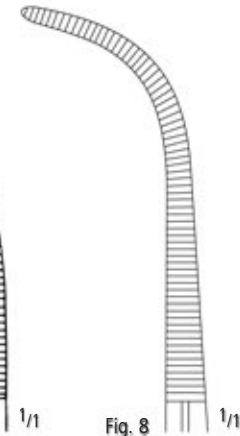

Fig. 8 1/1

AA 224/08



BABY-OVERHOLT

AA 225/13
 13,5 cm/5¹/₄"

Präparier- und Ligaturklemmen
 Dissecting and Ligature Forceps
 Pinzas para preparaciones y ligaduras
 Pincès à disséquer et à ligatures
 Pinze per preparazioni e legature

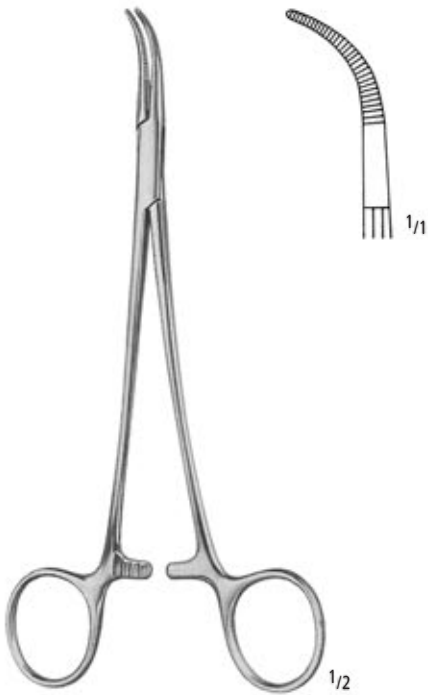

OVERHOLT
 AA 229/01
 18,5 cm/7¹/₃"

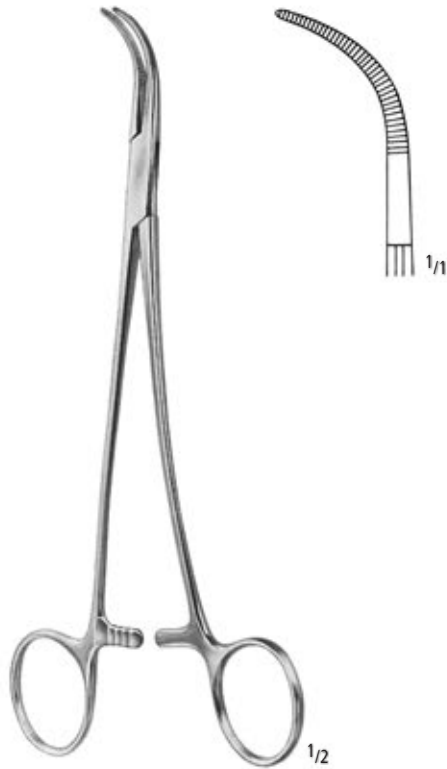

OVERHOLT
 AA 229/02
 20,5 cm/8"

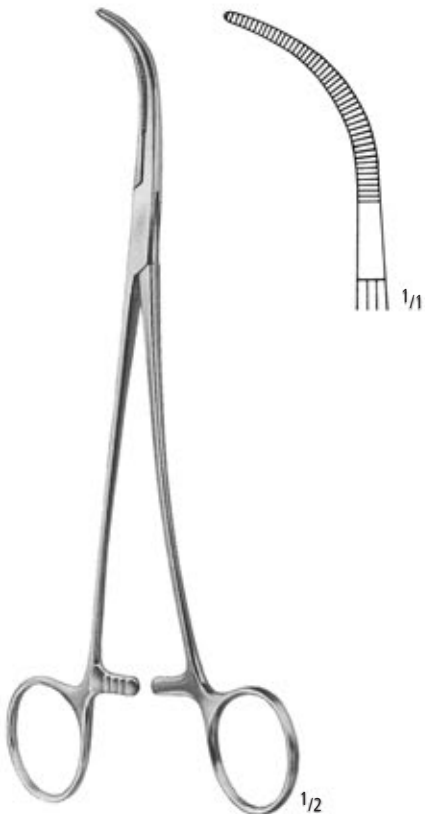

OVERHOLT
 AA 229/03
 21,0 cm/8¹/₄"

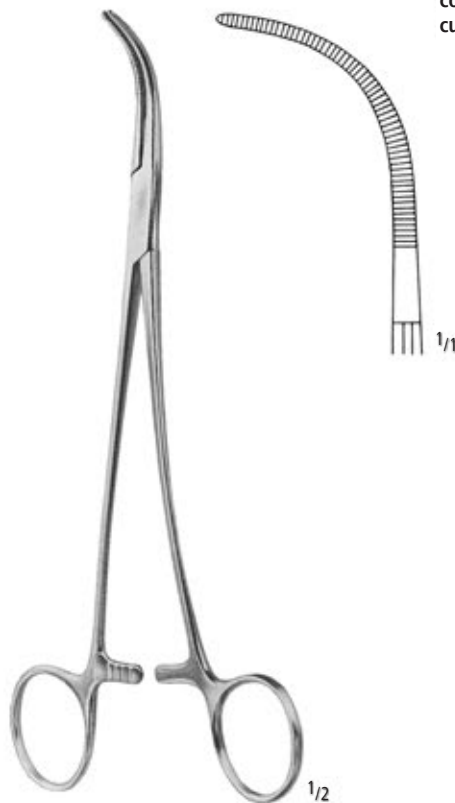

OVERHOLT
 AA 229/04
 21,5 cm/8¹/₂"

S-förmig gebogen
 S-shaped
 curvas en S
 courbes en S
 curve in S

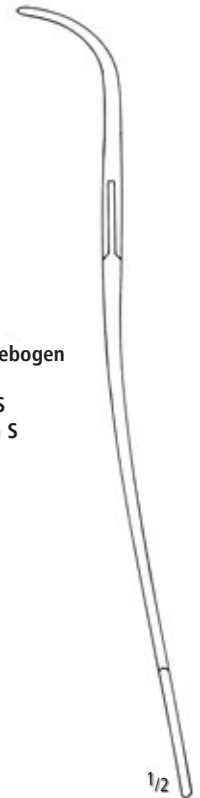

KLEMMEN HEMOSTATS PINZAS HEMOSTATICAS PINCES HEMOSTATIQUES PINZE EMOSTATICHE

Arterienklemmen, Präparier- und Ligaturklemmen
 Artery Forceps, Dissecting and Ligature Forceps
 Pinzas hemostáticas, Pinzas para preparaciones y ligaduras
 Pincas hémostatiques, Pincas à disséquer et à ligatures
 Pinze emostatiche, Pinze per preparazioni e legature

AA

AB

AC

AD

AE

AF

AK

AL

AO

AP

AR

KB

KI

KC

KU

KYE

X



BABY-ADSON
 AA 235/14
 14,0 cm/5 1/2"

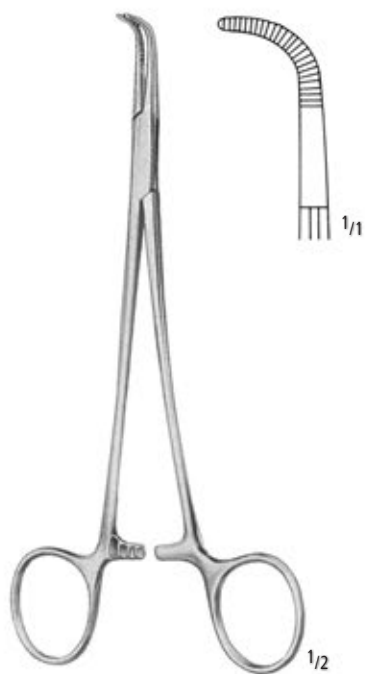

BABY-ADSON
 AA 237/18
 18,0 cm/7"



AA 238/18

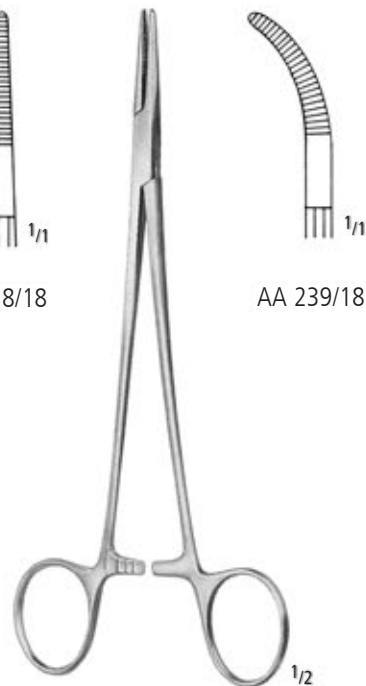

AA 239/18

ADSON
 18,5 cm/7 1/3"

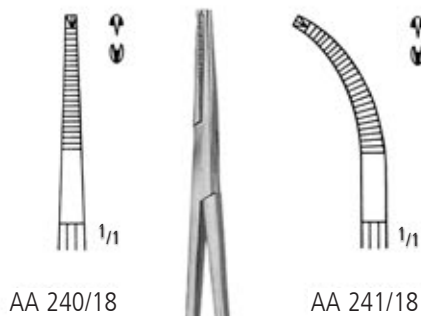

AA 240/18

AA 241/18

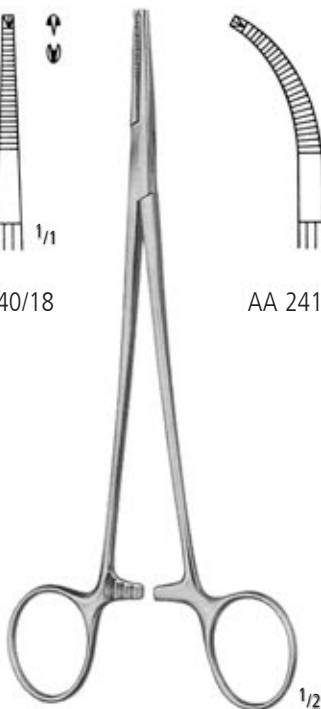

ADSON 1:2
 18,5 cm/7 1/3"



MEEKER

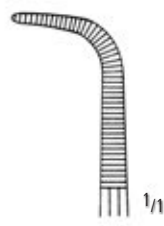

AA 251/18
 18,0 cm/7"

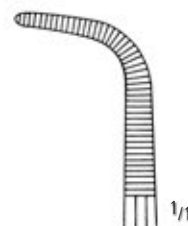

AA 251/28
 28,0 cm/11"

AA

KLEMMEN HEMOSTATS PINZAS HEMOSTATICAS PINCES HEMOSTATIQUES PINZE EMOSTATICHE

Arterienklemmen
 Artery Forceps
 Pinzas hemostáticas
 Pincas hémostatiques
 Pinze emostatiche

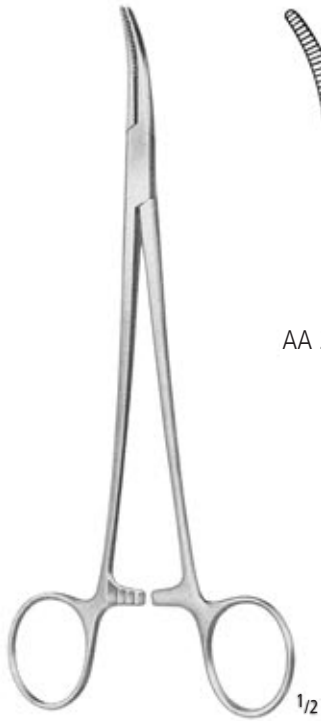

AA 295/01

SCHNIDT-SAWTELL

19,0 cm/7 1/2"



1/1



1/1

AA 295/02

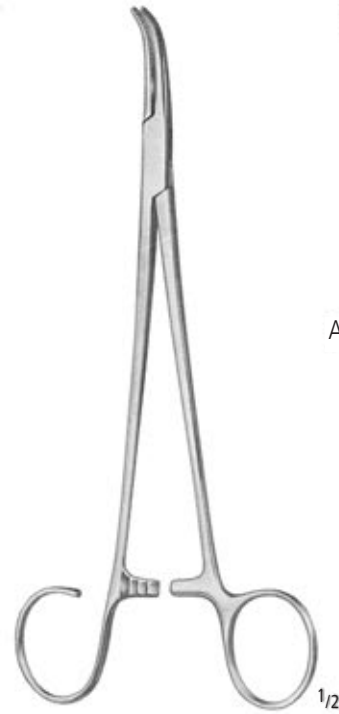

AA 297/01

SCHNIDT-SAWTELL

19,0 cm/7 1/2"



1/1



1/1

AA 297/02

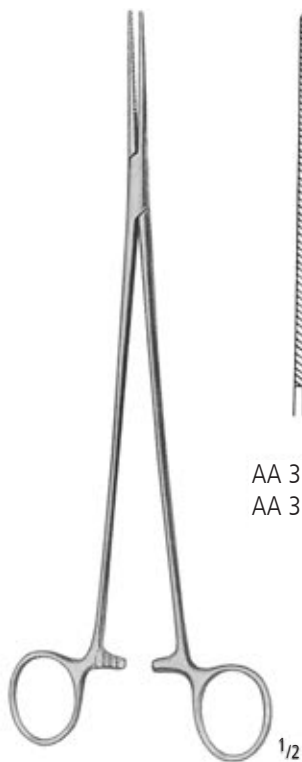

AA 310/20
 AA 310/26

BENGOLEA

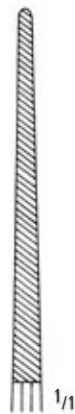

1/1

20,0 cm/8"
 26,0 cm/10 1/2"



1/1

AA 311/20
 AA 311/26

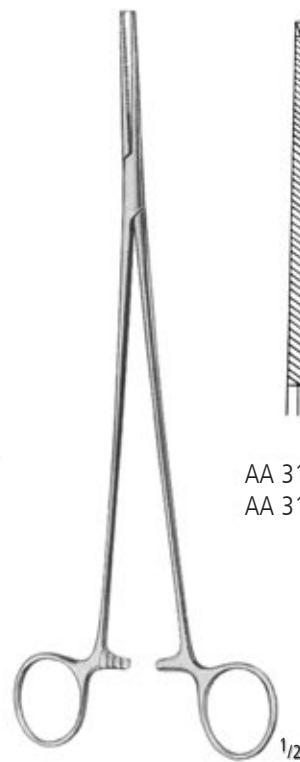

AA 312/20
 AA 312/26

BENGOLEA 1:2



1/1

20,0 cm/8"
 26,0 cm/10 1/2"



1/1

AA 313/20
 AA 313/26

Präparier- und Ligaturklemmen
 Dissecting and Ligature Forceps
 Pinzas para preparaciones y ligaduras
 Pincès à disséquer et à ligatures
 Pinze per preparazioni e legature

AA

AB

AC

AD

AE

AF

AK

AL

AO

AP

AR

KB

KI

KC

KU

KYE

X



RUMEL
 23,0 cm/9"



AA 335/01

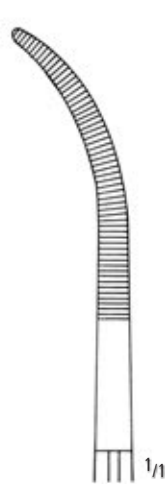

AA 335/02

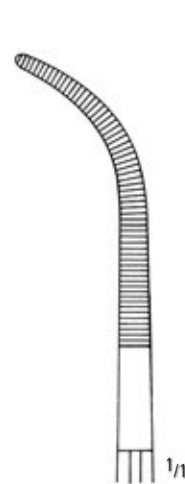

AA 335/03

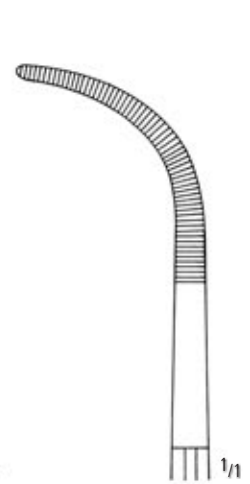

AA 335/04

Präparier- und Ligaturklemmen
 Dissecting and Ligature Forceps
 Pinzas para preparaciones y ligaduras
 Pincès à disséquer et à ligatures
 Pinze per preparazioni e legature

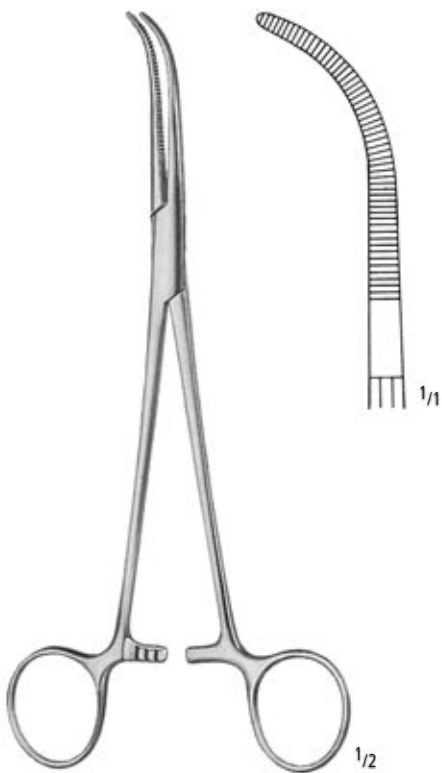

JOHNS HOPKINS
 AA 338/20
 20,0 cm/8"

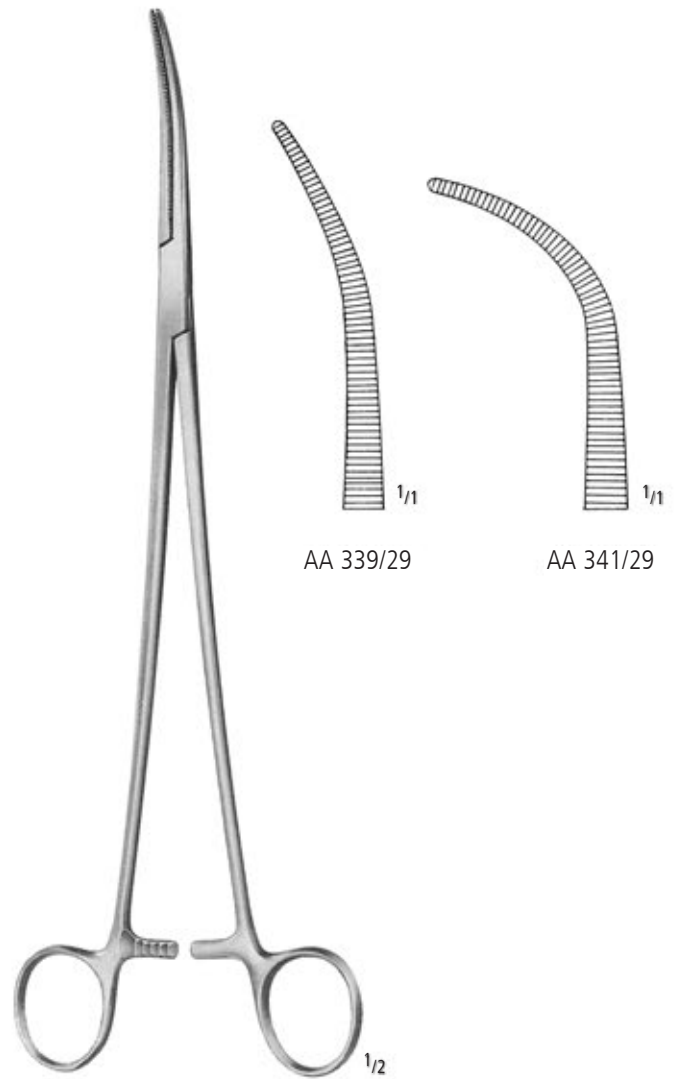

ZENKER
 29,5 cm/11 1/2"

Präparier- und Ligaturklemmen
 Dissecting and Ligature Forceps
 Pinzas para preparaciones y ligaduras
 Pincas à disséquer et à ligatures
 Pinze per preparazioni e legature

AA

AB

AC

AD

AE

AF

AK

AL

AO

AP

AR

KB

KI

KC

KU

KYE

X

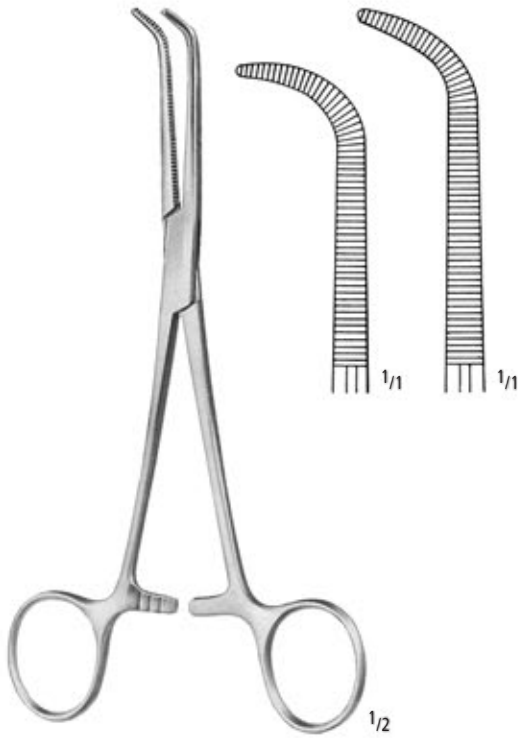

MIXTER
 15,5 cm/6" AA 345/15
 19,0 cm/7 1/2" AA 345/19

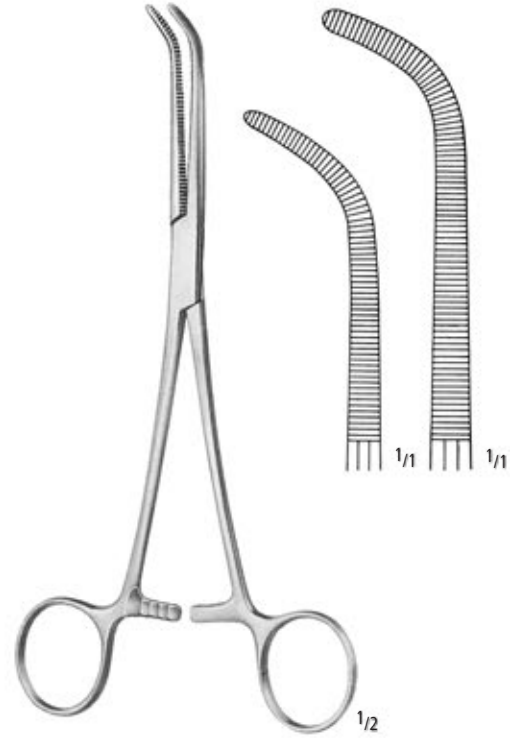

MIXTER-O'SHAUGNESSY
 15,5 cm/6" AA 347/15
 19,0 cm/7 1/2" AA 347/19

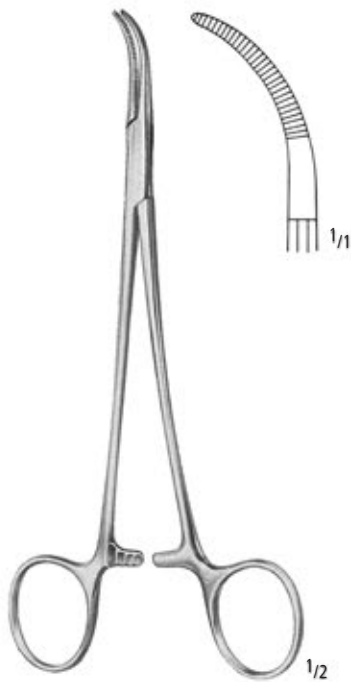

BABY-MIXTER
 AA 348/18
 18,0 cm/7"

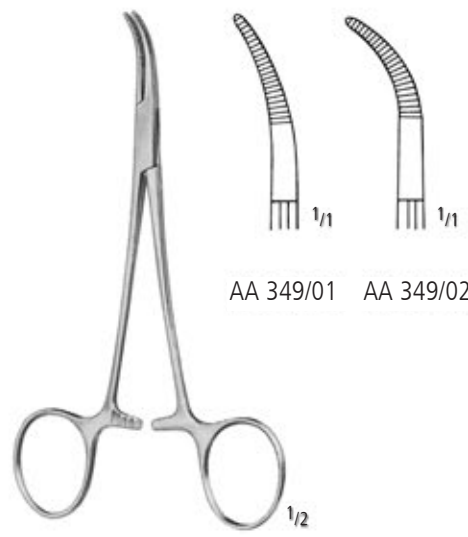

AA 349/01 AA 349/02

BABY-MIXTER
 14,0 cm/5 1/2"

Präparier- und Ligaturklemmen
 Dissecting and Ligature Forceps
 Pinzas para preparaciones y ligaduras
 Pincès à disséquer et à ligatures
 Pinze per preparazioni e legature

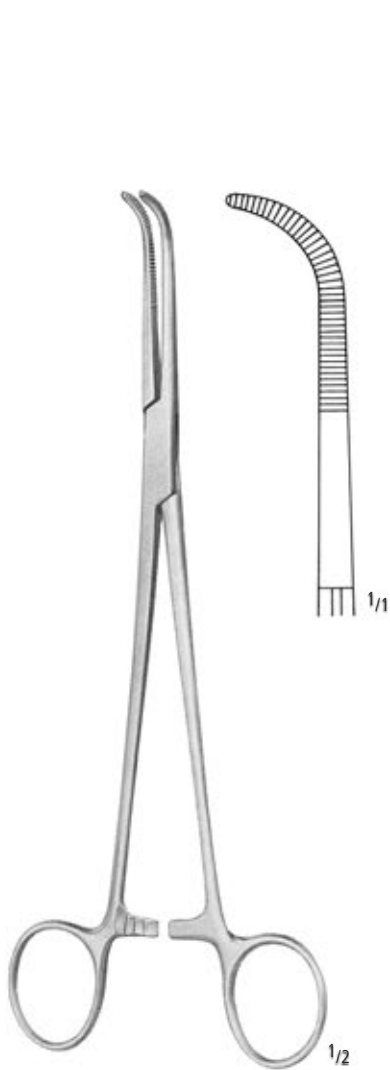

MIXTER
 AA 355/23
 23,0 cm/9"



BRIDGE
 28,0 cm/11"



LAWRENCE
 AA 361/28
 28,0 cm/11"

Präparier- und Ligaturklemmen
 Dissecting and Ligature Forceps
 Pinzas para preparaciones y ligaduras
 Pincès à disséquer et à ligatures
 Pinze per preparazioni e legature

AA

AB

AC

AD

AE

AF

AK

AL

AO

AP

AR

KB

KI

KC

KU

KYE

X



KANTROWITZ

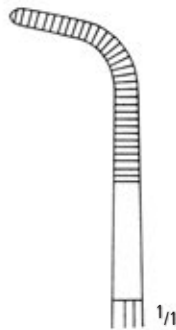

AA 363/20
20,0 cm/8"

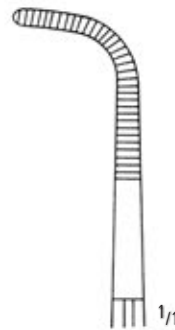

AA 363/24
24,0 cm/9 1/2"

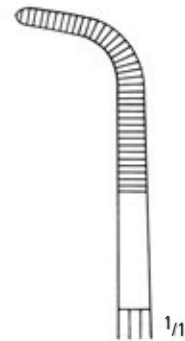

AA 363/28
28,0 cm/11"



GEMINI

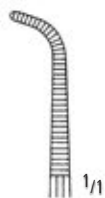

AA 365/14
14,0 cm/5 1/2"



AA 365/18
18,0 cm/7"



AA 365/22
22,0 cm/8 3/4"

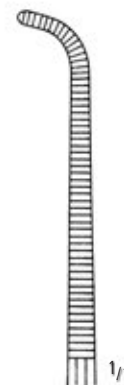

AA 365/25
25,0 cm/10"

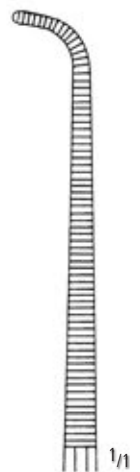

AA 365/28
28,0 cm/11"

Präparier- und Ligaturklemmen
 Dissecting and Ligature Forceps
 Pinzas para preparaciones y ligaduras
 Pincès à disséquer et à ligatures
 Pinze per preparazioni e legature

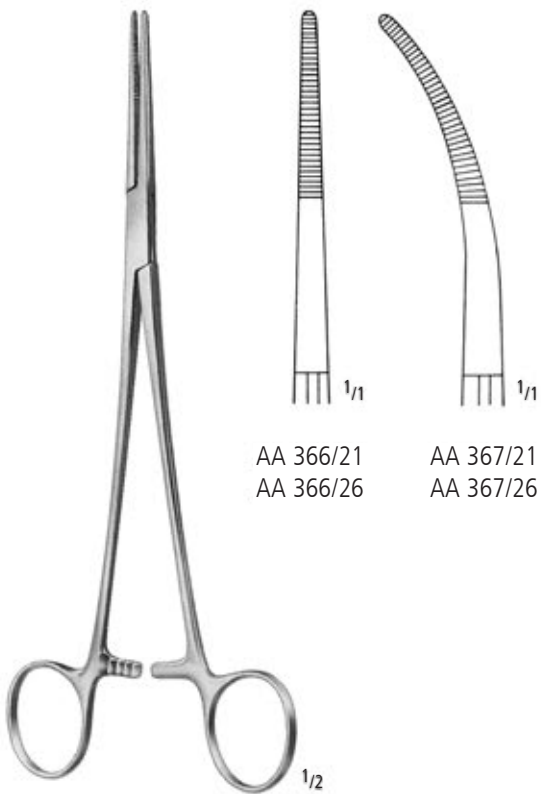

AA 366/21
 AA 366/26

AA 367/21
 AA 367/26

TOENNIS
 21,0 cm/8¹/₄"
 26,0 cm/10¹/₂"

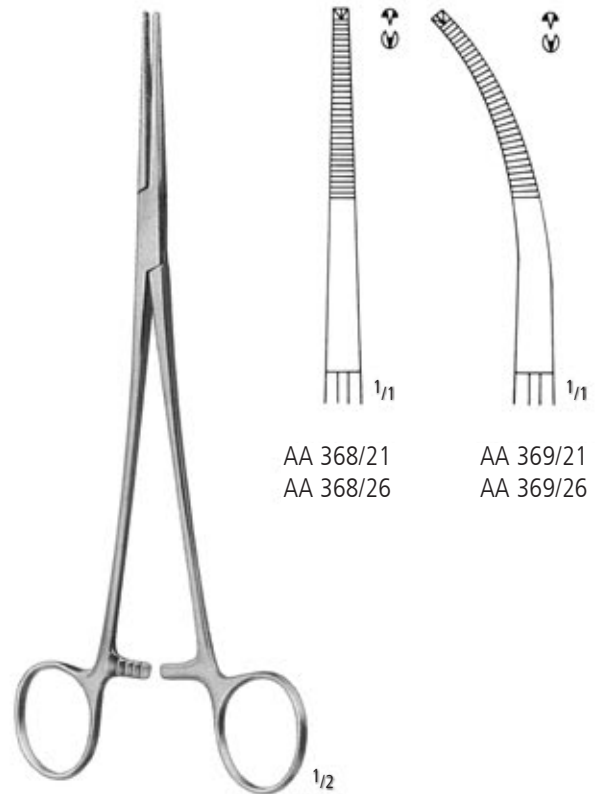

AA 368/21
 AA 368/26

AA 369/21
 AA 369/26

TOENNIS 1:2
 21,0 cm/8¹/₄"
 26,0 cm/10¹/₂"

Gallenkanal- und Nierenstielklemmen
 Gall Duct and Kidney Pedicle Clamp Forceps
 Pinzas-clamps para conducto biliar y pedúnculos renales
 Pincas-clamps pour voies biliaires et pédicules rénaux
 Pinze per vie biliari e peduncoli renali

AA

AB

AC

AD

AE

AF

AK

AL

AO

AP

AR

KB

KI

KC

KU

KYE

X

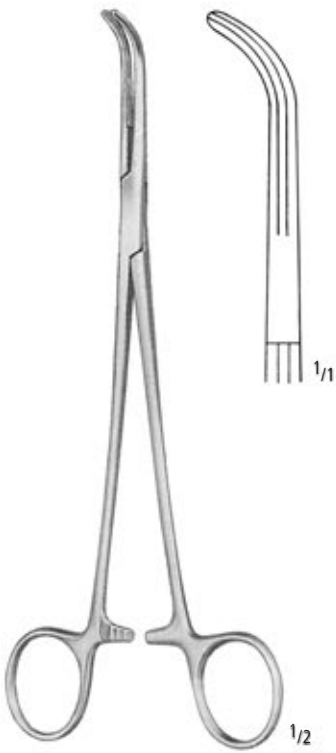

LAHEY
 AA 401/19
 19,0 cm/7½"

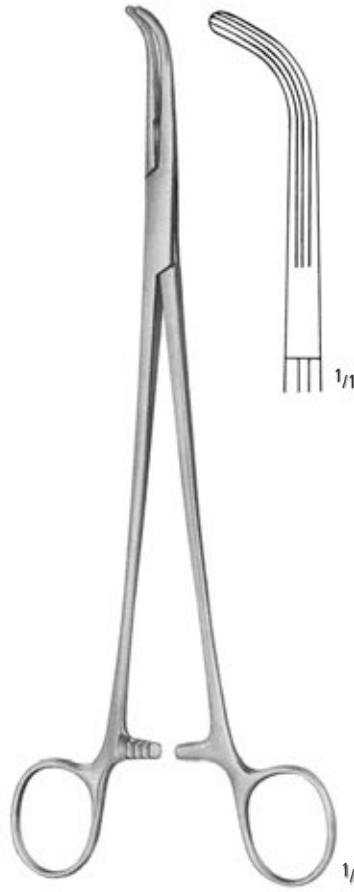

LAHEY
 AA 401/23
 23,0 cm/9"



LOWER
 AA 403/18
 18,0 cm/7"

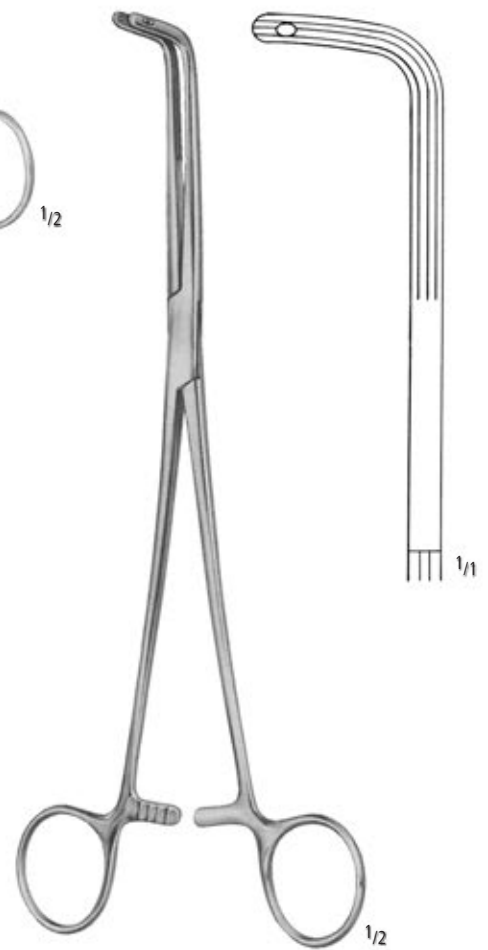

FINOCCHIETTO
 AA 405/24
 24,0 cm/9½"

Nierenstielklemmen
 Kidney Pedicle Clamp Forceps
 Pinzas-clamps para pedúnculos renales
 Pincas-clamps pour pédicules rénaux
 Pinze per peduncoli renali

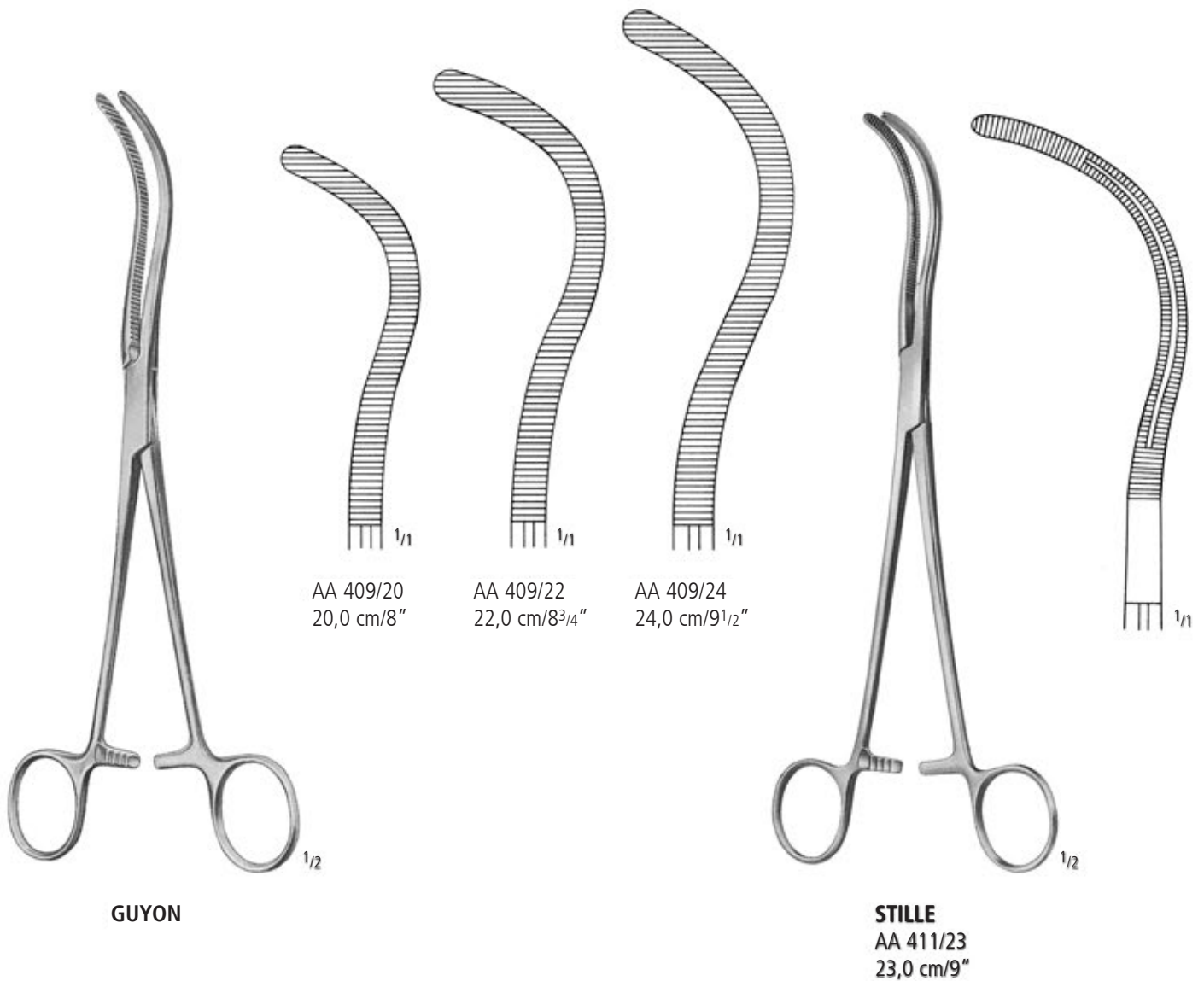

Nierenstielklemmen
Kidney Pedicle Clamp Forceps
Pinzas-clamps para pedúnculos renales
Pincas-clamps pour pédicules rénaux
Pinze per peduncoli renali

AA

AB

AC

AD

AE

AF

AK

AL

AO

AP

AR

KB

KI

KC

KU

KYE

X

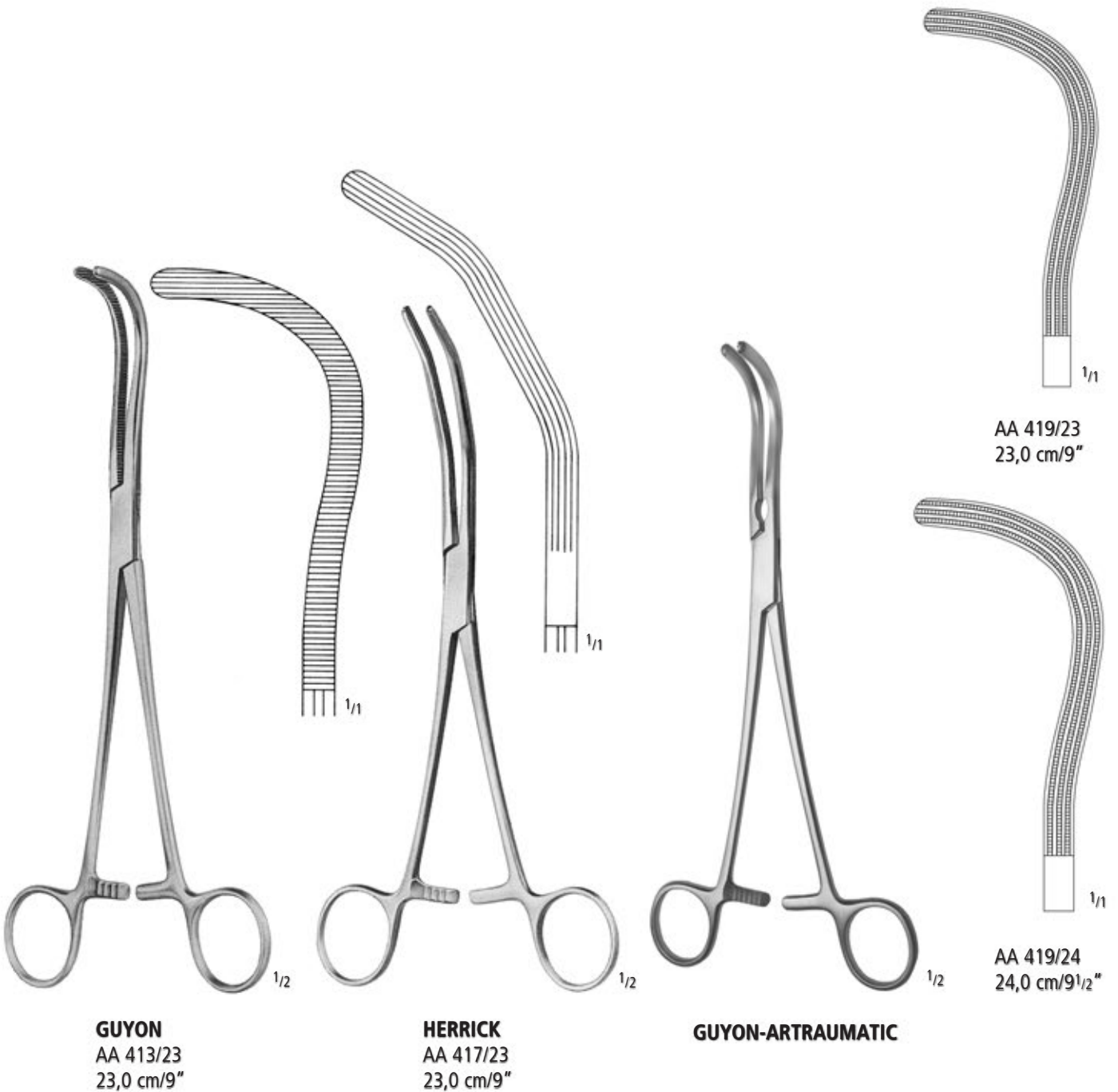

Gallenkanalklemmen
 Gall Duct Forceps
 Pinzas-clamps para conducto biliar
 Pincas-clamps pour voies biliaires
 Pinze per vie biliari

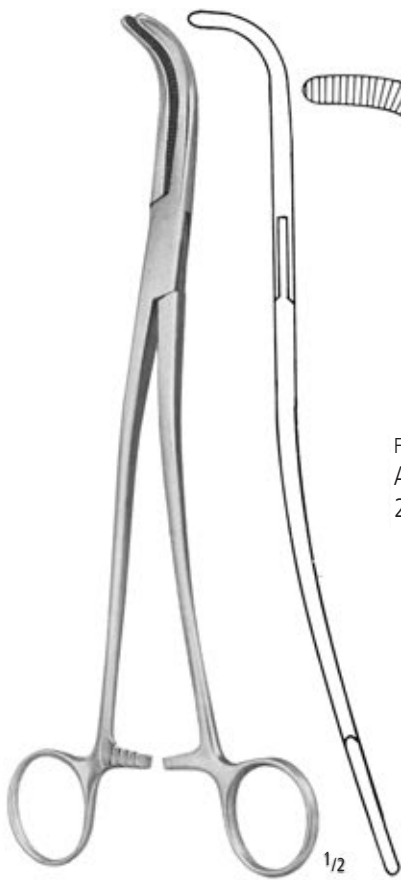

GRAY

Fig. 1
 AA 423/22
 22,0 cm/8³/₄"

Fig. 2
 AA 423/23
 23,0 cm/9"

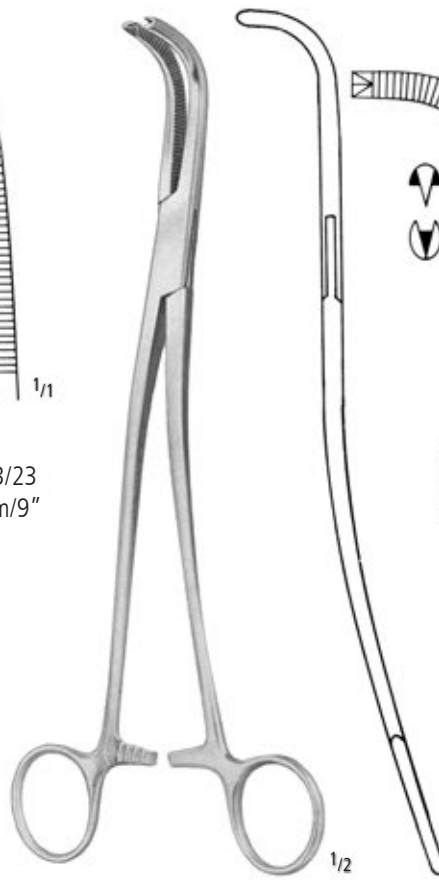

GRAY 1:2

Fig. 1
 AA 425/22
 22,0 cm/8³/₄"

Fig. 2
 AA 425/23
 23,0 cm/9"

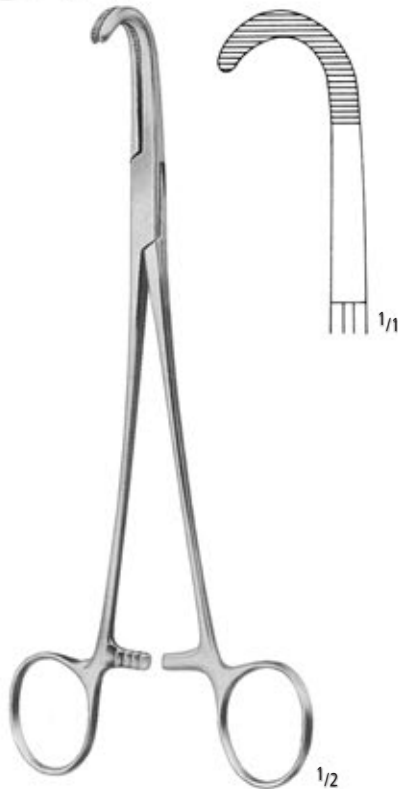

DESJARDINS
 AA 429/21
 21,0 cm/8¹/₄"

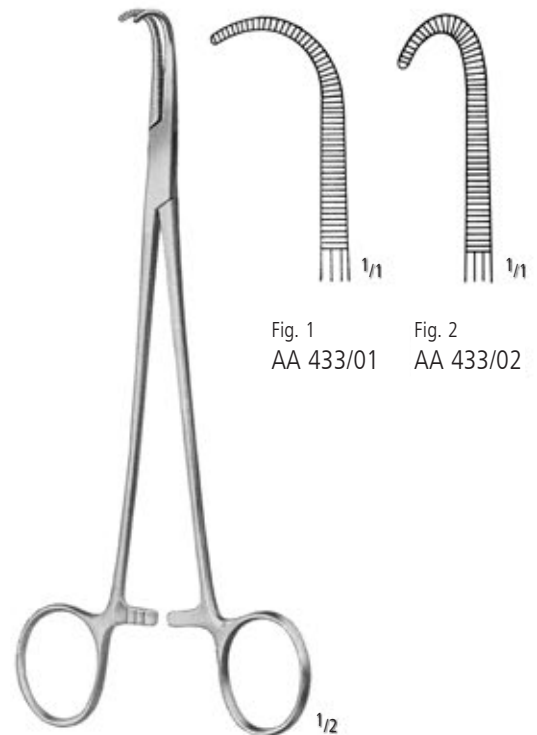

NEGUS
 19,0 cm/7¹/₂"

Fig. 1
 AA 433/01

Fig. 2
 AA 433/02

KLEMMEN HEMOSTATS PINZAS HEMOSTATICAS PINCES HEMOSTATIQUES PINZE EMOSTATICHE

Präparier- und Ligaturklemmen, Hysterektomieklemmen
 Dissecting and Ligature Forceps, Hysterectomy Forceps
 Pinzas para preparaciones y ligaduras, Pinzas-clamps para histerec-
 tomía
 Pincers à disséquer et à ligatures, Pincers à hystérectomie
 Pinze per preparazioni e legature, Pinze per isterectomia

AA

AB

AC

AD

AE

AF

AK

AL

AO

AP

AR

KB

KI

KC

KU

KYE

X

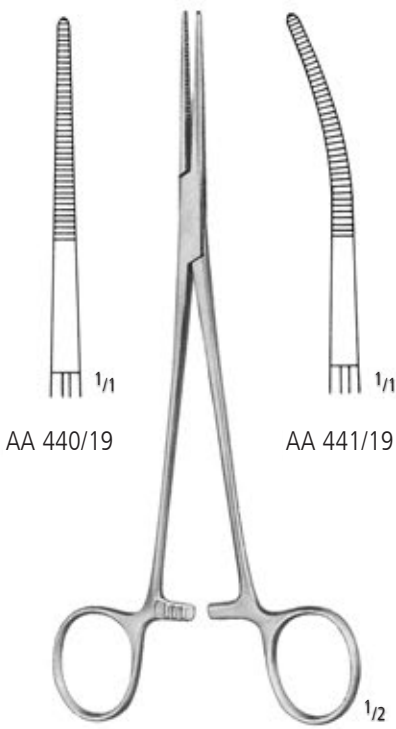

BIRKETT
 19,0 cm/7 1/2"

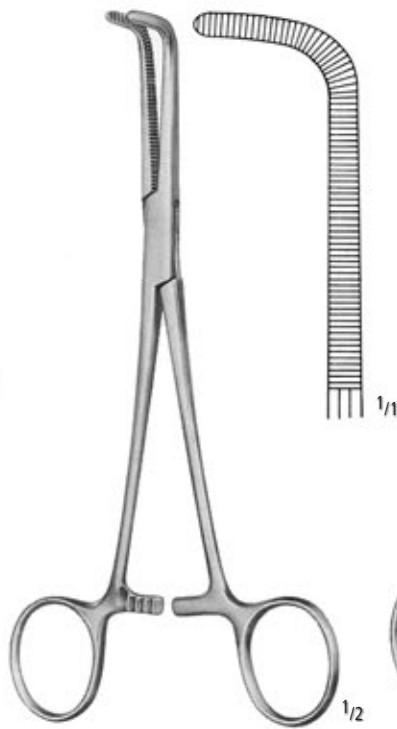

WIKSTROEM
 AA 443/19
 19,0 cm/7 1/2"

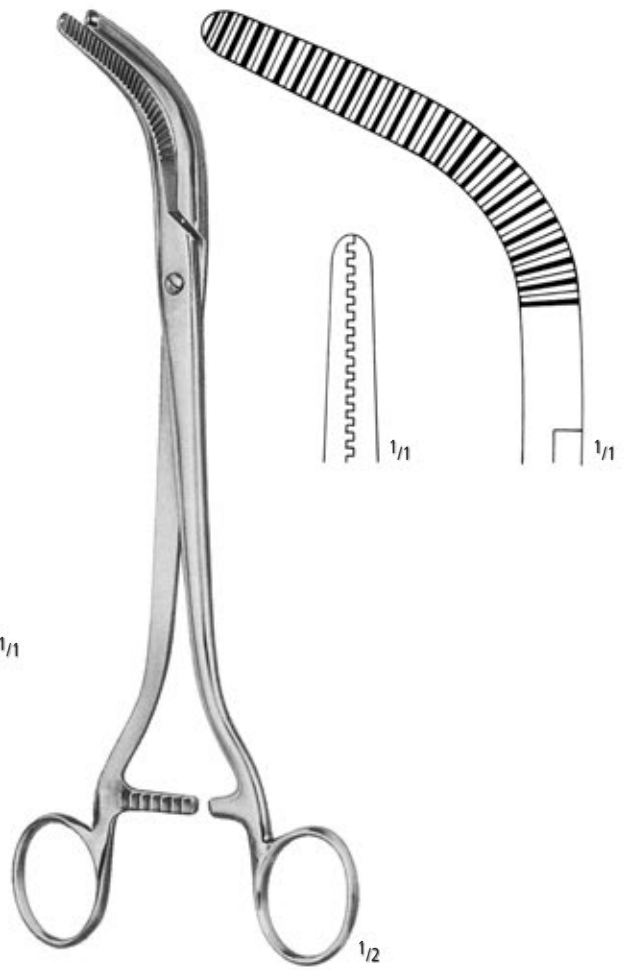

WERTHEIM
 AA 500/27
 27,0 cm/10 3/4"

Hysterektomieklemmen
 Hysterectomy Forceps
 Pinzas-clamps para histerectomía
 Pincas à hystérectomie
 Pinze per isterectomia

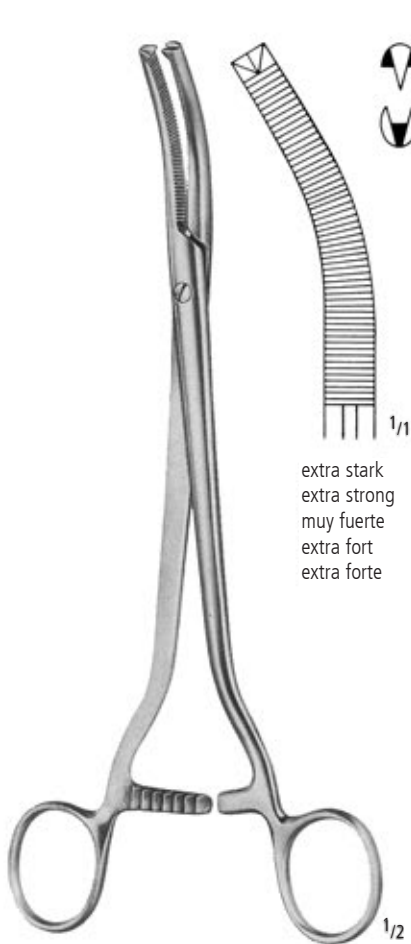

extra stark
 extra strong
 muy fuerte
 extra fort
 extra forte

WERTHEIM 1:2
 AA 501/24
 24,0 cm/9 1/2"

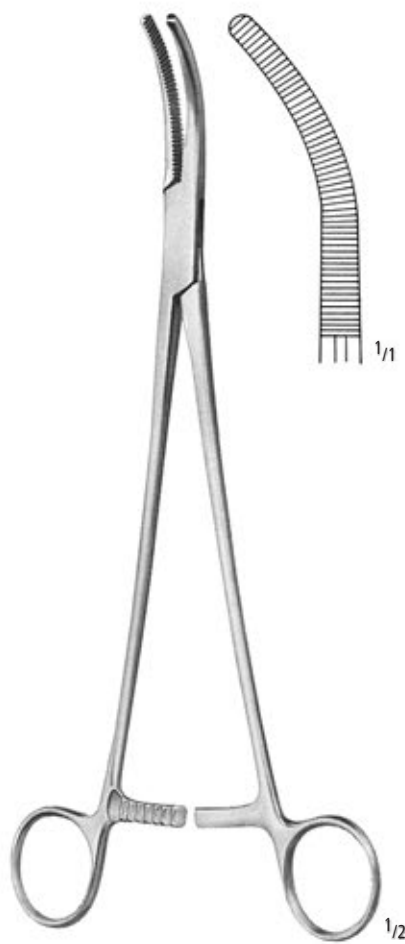

WERTHEIM
 AA 502/25
 25,0 cm/10"

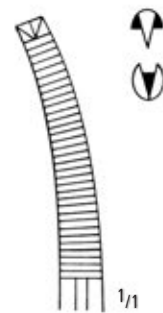

AA 503/23
 leicht gebogen
 slightly curved
 curva ligeramente
 courbure légère
 curva leggera

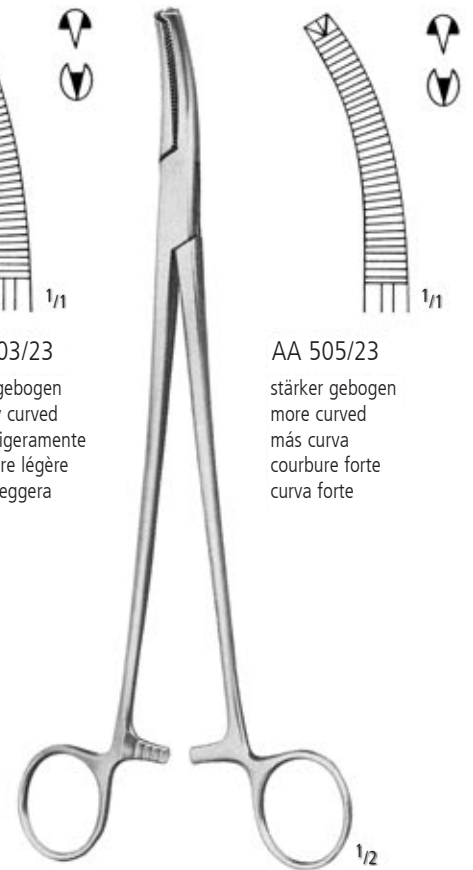

AA 505/23
 stärker gebogen
 more curved
 más curva
 courbure forte
 curva forte

WERTHEIM 1:2
 23,0 cm/9"

Hysterektomieklemmen
 Hysterectomy Forceps
 Pinzas-clamps para histerectomía
 Pincès à hystérectomie
 Pinze per isterectomia

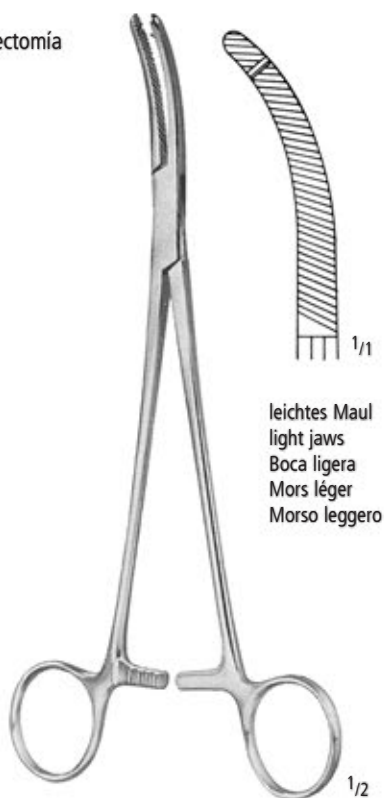

leichtes Maul
 light jaws
 Boca ligera
 Mors léger
 Morso leggero

HEANEY
 AA 507/21
 21,0 cm/8¹/₄"

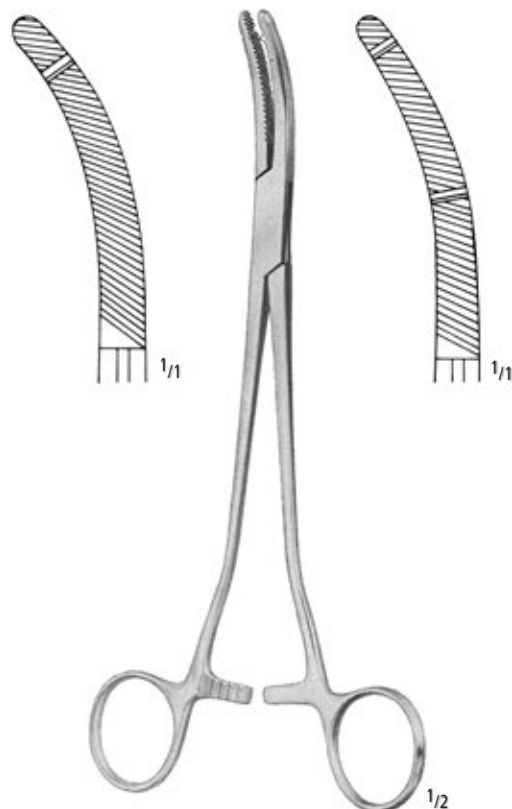

HEANEY
 AA 511/21 21,0 cm/8¹/₄" AA 513/21
 AA 511/23 23,0 cm/9" AA 513/23

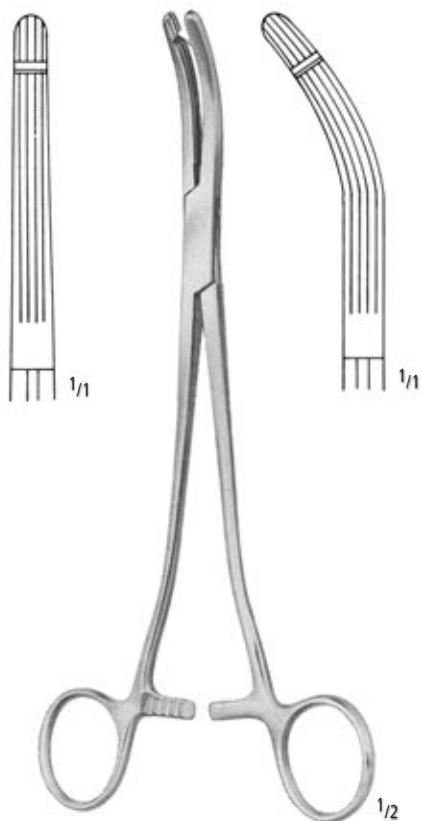

HEANEY-BALLANTINE
 AA 514/21 21,0 cm/8¹/₄" AA
 515/21

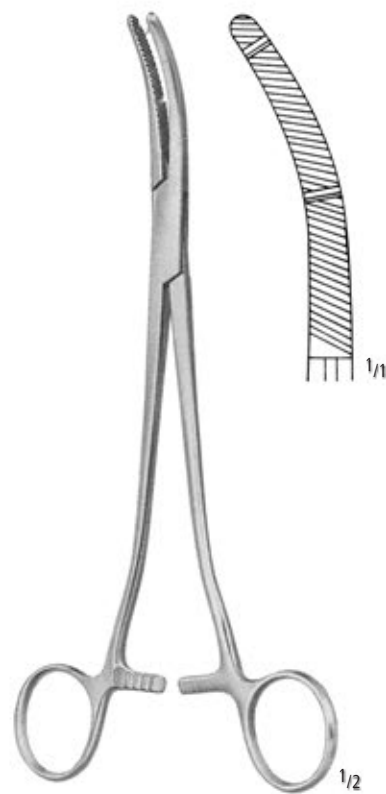

HEANEY-KANTER
 AA 517/21
 21,0 cm/8¹/₄"

AA
 AB
 AC
 AD
 AE
 AF
 AK
 AL
 AO
 AP
 AR
 KB
 KI
 KC
 KU
 KYE
 X

Hysterektomieklemmen
 Hysterectomy Forceps
 Pinzas-clamps para histerectomía
 Pincès à hystérectomie
 Pinze per isterectomia

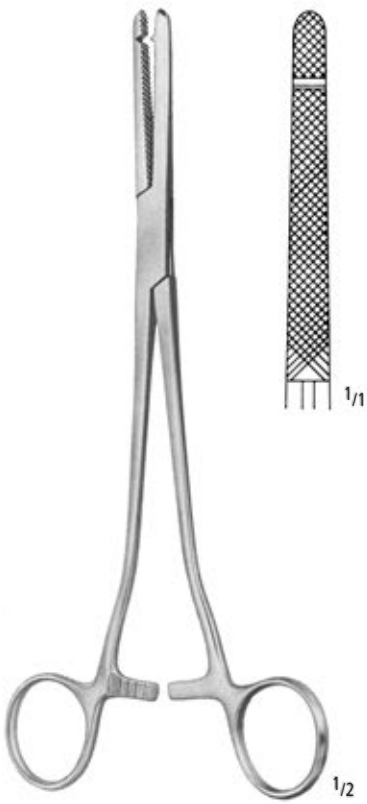

HEANEY-REZAK
 AA 519/21
 21,0 cm/8¹/₄"

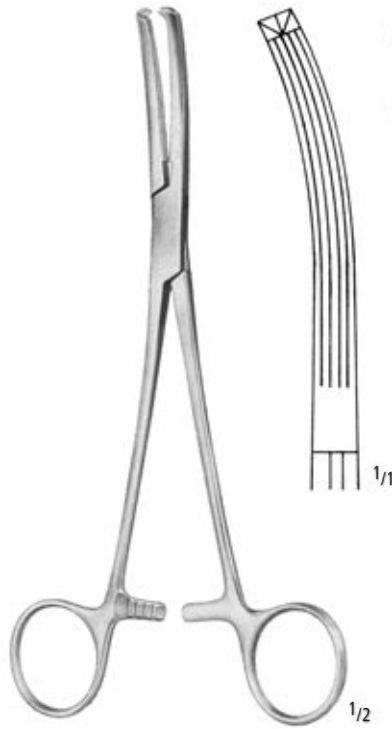

LONG
 AA 521/19
 19,0 cm/7¹/₂"

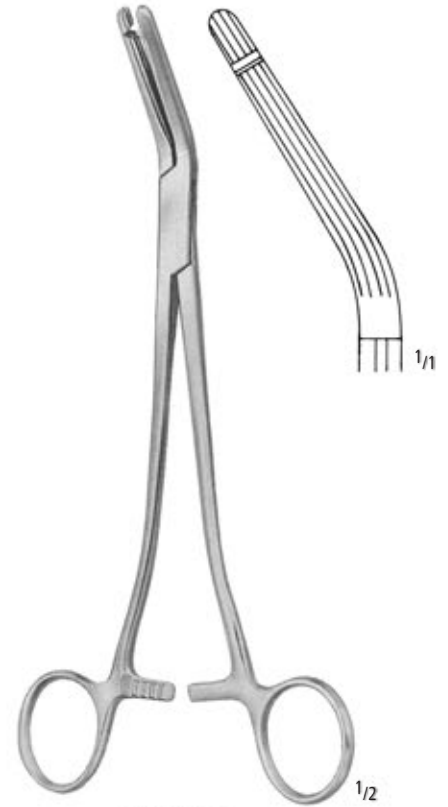

GARLAND
 AA 523/21
 21,0 cm/8¹/₄"



AA 524/20
 20,0 cm/8"



AA 524/21
 21,0 cm/8¹/₄"



AA 524/25
 25,0 cm/10"

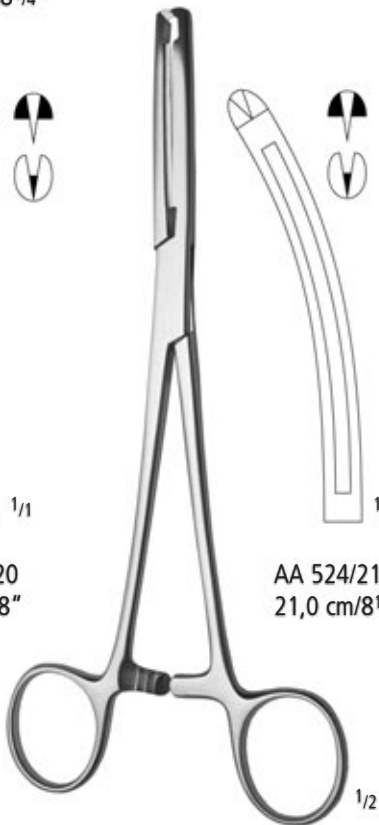

MAGINOT

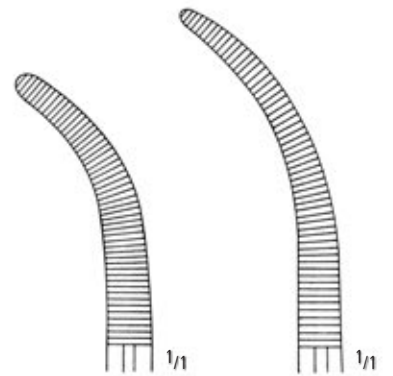

AA 525/23
 23,0 cm/9"

AA 527/24
 24,0 cm/9¹/₂"

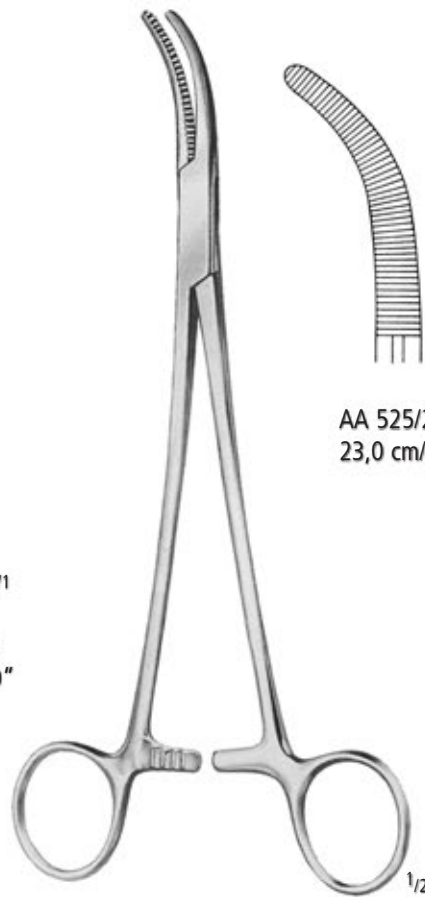

MOYNIHAN

Hysterektomieklemmen
 Hysterectomy Forceps
 Pinzas-clamps para histerectomía
 Pincas à hystérectomie
 Pinze per isterectomia



WERTHEIM-CULLEN
 AA 529/21
 21,5 cm/8½"

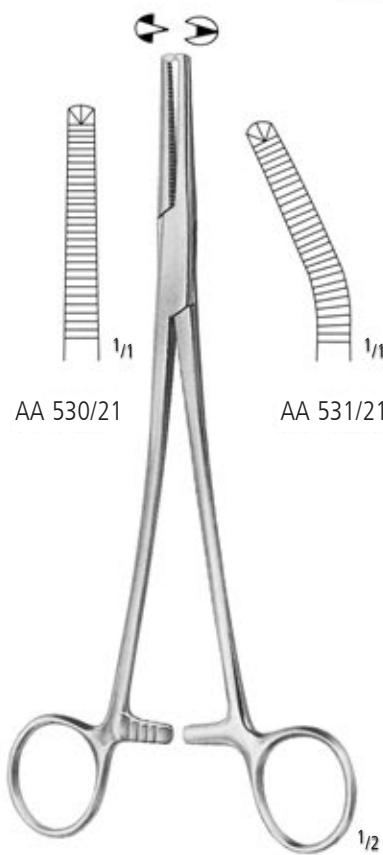

PHANEUF 1:2
 21,5 cm/8½"

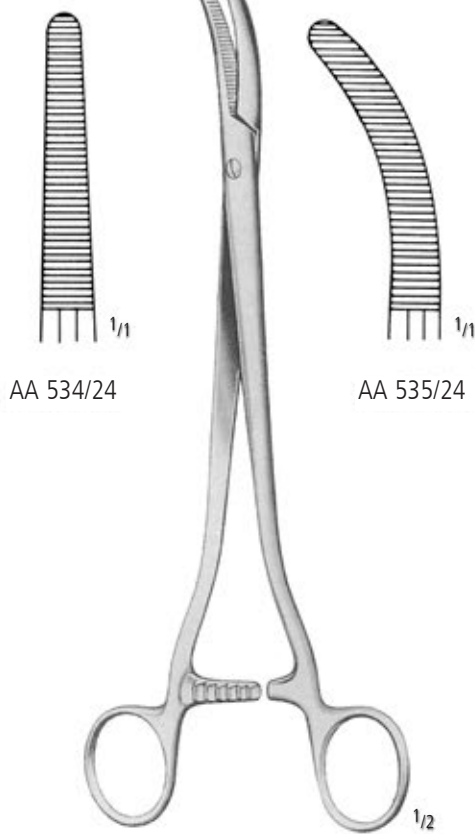

SEGOND-LANDAU
 24,0 cm/9½"

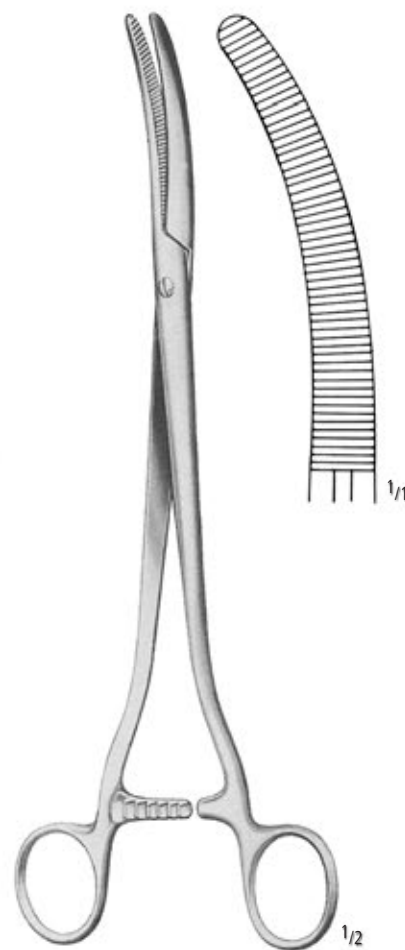

FAURE
 AA 537/25
 25,0 cm/10"

SEGOND
 24,0 cm/9½"

AA
 AB
 AC
 AD
 AE
 AF
 AK
 AL
 AO
 AP
 AR
 KB
 KI
 KC
 KU
 KYE
 X

Parametriumklemmen
 Parametrium Forceps
 Pinzas-clamps para parametrium
 Pincas-clamps pour parametrium
 Pinze per parametrium



PARAMETRIUM
 21,0 cm/8 1/4"

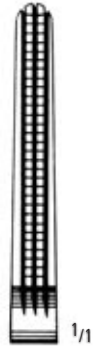

AA 540/00



AA 541/01



AA 541/02

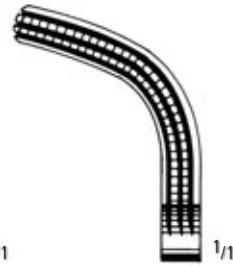

AA 541/03

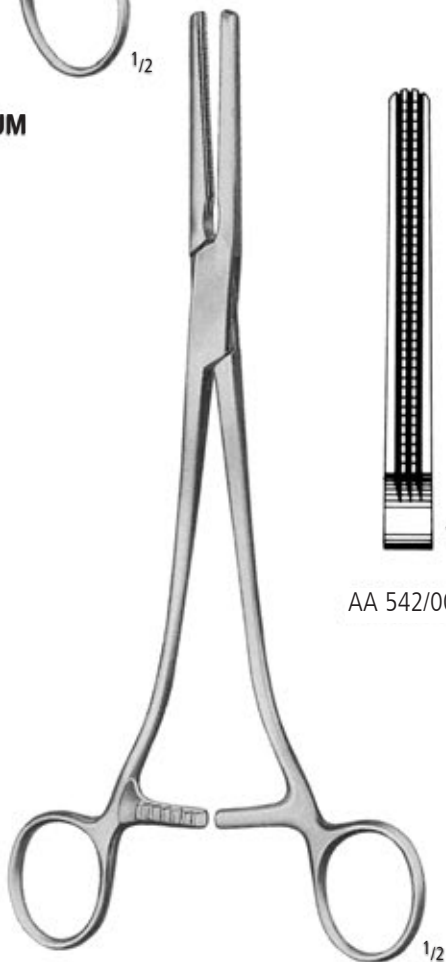

PARAMETRIUM
 24,0 cm/9 1/2"

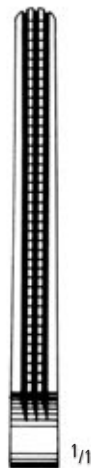

AA 542/00



AA 543/01

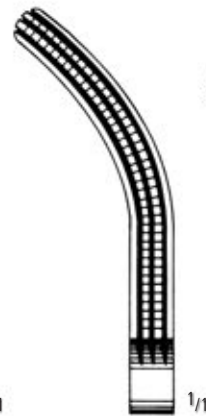

AA 543/02



AA 543/03

Tuchklemmen
Towel Forceps
Pinzas para compresas, Pinzas de campo
Pinces à champs, Pinces à compresses
Pinze per fissare le compresse (Fissatele)

AA

AB

AC

AD

AE

AF

AK

AL

AO

AP

AR

KB

KI

KC

KU

KYE

X



1/2

SCHAEDEL
AA 710/09
9,0 cm/3 1/2"



1/2

JONES
5,0 cm/2" AA 711/05
9,0 cm/3 1/2" AA 711/09



1/2

ENGL. MODELL
AA 717/09
9,0 cm/3 1/2"



1/2

DOYEN
AA 721/18
18,0 cm/7"



1/2

BERNHARD
AA 726/16
16,5 cm/6 1/2"



1/2

LANE
15,0 cm/6" AA 730/15
18,0 cm/7" AA 730/18
20,0 cm/8" AA 730/20

Tuchklemmen
Towel Forceps
Pinzas para compresas, Pinzas de campo
Pinces à champs, Pinces à compresses
Pinze per fissare le compresse (Fissatele)



AA 749/11
11,0 cm/4¹/₃"

- mit Schlauch- oder Kabelhalter
- with clip for tubing or cable
- con porta-tubo o porta-cable
- avec clamp porte-tube ou porte-corton d'alimentation
- con porta tubo o porta cavo



BACKHAUS

- | | |
|---|-----------|
| 8,0 cm/3" | AA 751/08 |
| 11,0 cm/4 ¹ / ₃ " | AA 751/11 |
| 13,0 cm/5" | AA 751/13 |
| 15,0 cm/6" | AA 751/15 |

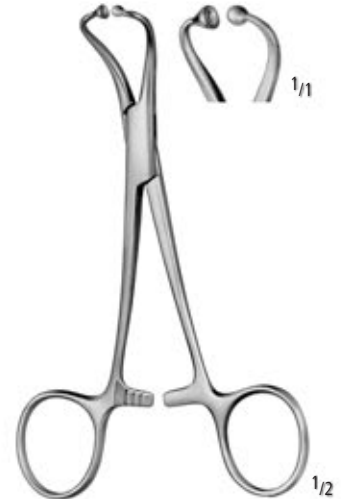

BALL & SOCKET

- | | |
|---|-----------|
| 11,0 cm/4 ¹ / ₃ " | AA 753/11 |
| 13,0 cm/5" | AA 753/13 |

für Papiertücher
for paper tissues
para servilletas de papel
pour serviettes en papier
per tessuti di carta



ROEDER

- | | |
|------------|-----------|
| 13,0 cm/5" | AA 761/13 |
| 15,0 cm/6" | AA 761/15 |



LORNA

- | | |
|------------|-----------|
| 10,0 cm/4" | AA 763/10 |
| 13,0 cm/5" | AA 763/13 |

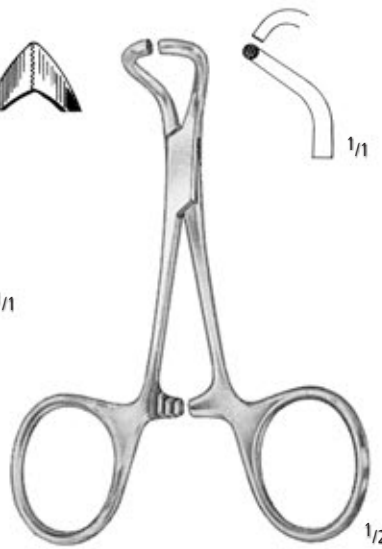

TOHOKU-JAPAN

- | | |
|------------|-----------|
| 10,0 cm/4" | AA 764/10 |
| 13,0 cm/5" | AA 764/13 |

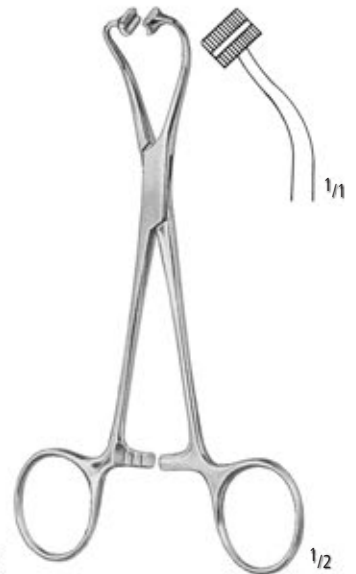

PEERS

- | |
|---|
| AA 765/14 |
| 14,5 cm/5 ³ / ₄ " |

Schlauchklemmen
Tubing Clamps
Pinzas para tubos
Presses-tube
Pinze serratubi

AA

AB

AC

AD

AE

AF

AK

AL

AO

AP

AR

KB

KI

KC

KU

KYE

X

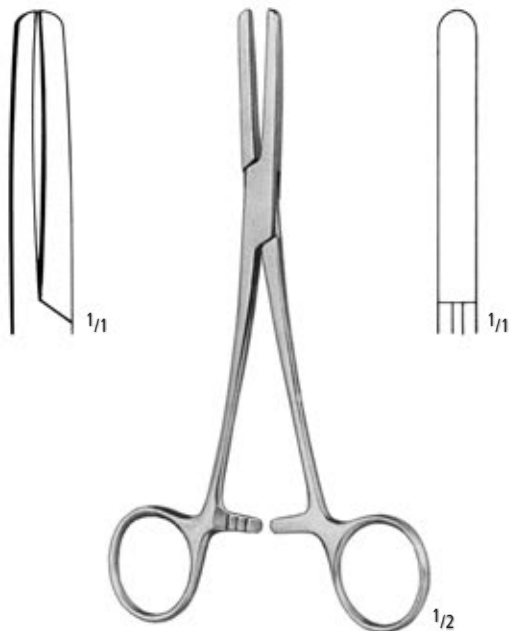

PRESBYTERIAN

16,5 cm/6¹/₂" AA 790/16
18,0 cm/7" AA 790/18



KLINIKUM BERLIN

AA 792/14
14,5 cm/5³/₄"
mit langer Sperre
with long ratchet
con cremallera larga
à crémaillère extra longue
con cremagliera extra lunga



AA 794/15

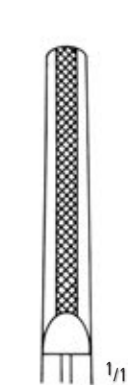

AA 794/18



AA 794/20

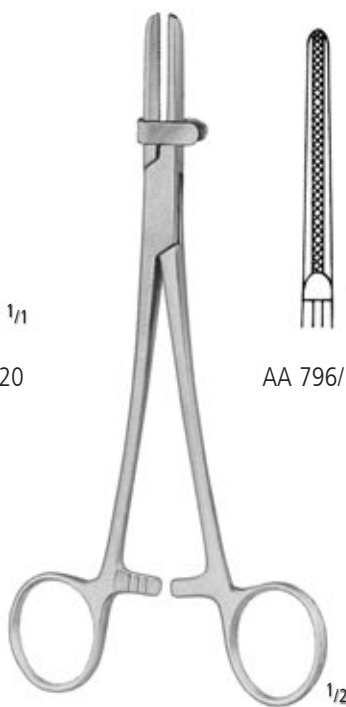

AA 796/15

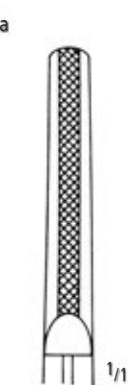

AA 796/18

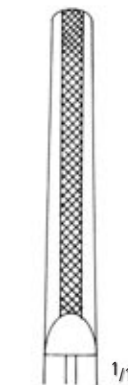

AA 796/20

AA 794/15 15,5 cm/6"
AA 794/18 18,0 cm/7"
AA 794/20 20,0 cm/8"

AA 796/15
AA 796/18
AA 796/20



PINZETTEN

FORCEPS

PINZAS

PINCES

PINZE

AB

nopa[®] instruments

Weitere Pinzetten finden Sie in unserem Katalog „Allgemeines Instrumentarium“ in Gruppe AB.

For further forceps kindly refer to our catalogue „General Instruments“, section AB.

Para pinzas adicionales, por favor consulte nuestro catálogo de „Instrumental de uso general“, grupo AB.

Pour des pinces supplémentaires, consultez notre catalogue „Instrumentation Generale“, section AB.

Per gli altri pinze, consultare il nostro catalogo „Strumentazione Generale“, gruppo AB.





PINZETTEN FORCEPS PINZAS PINCES PINZE

Anatomische Pinzetten, Chirurgische Pinzetten
 Dressing Forceps, Tissue Forceps
 Pinzas de disección, Pinzas de disección con dientes
 Pincers à dissection, Pincers à griffes
 Pinze anatomiche per dissezione, Pinze chirurgiche a denti di topo



1/2

STANDARD

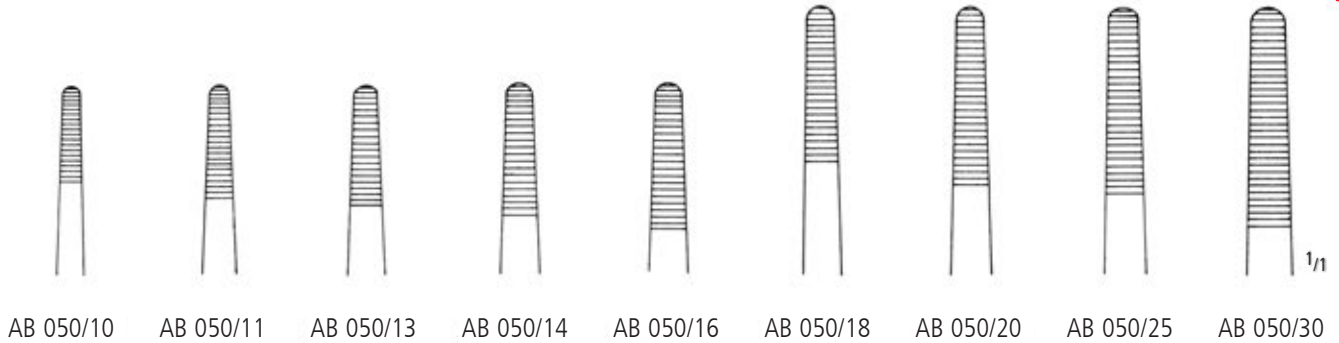

AB 050/10 AB 050/11 AB 050/13 AB 050/14 AB 050/16 AB 050/18 AB 050/20 AB 050/25 AB 050/30

10,5 cm/4 1/4"	AB 050/10
11,5 cm/4 1/2"	AB 050/11
13,0 cm/5"	AB 050/13
14,5 cm/5 3/4"	AB 050/14
16,0 cm/6 1/4"	AB 050/16
18,0 cm/7"	AB 050/18
20,0 cm/8"	AB 050/20
25,0 cm/10"	AB 050/25
30,0 cm/12"	AB 050/30



1/2

1:2
STANDARD

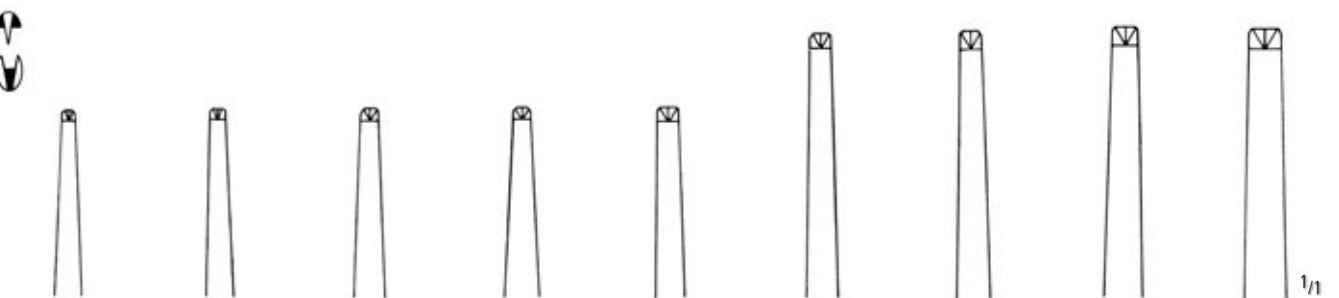

AB 060/10 AB 060/11 AB 060/13 AB 060/14 AB 060/16 AB 060/18 AB 060/20 AB 060/25 AB 060/30

10,5 cm/4 1/4"	AB 060/10
11,5 cm/4 1/2"	AB 060/11
13,0 cm/5"	AB 060/13
14,5 cm/5 3/4"	AB 060/14
16,0 cm/6 1/4"	AB 060/16
18,0 cm/7"	AB 060/18
20,0 cm/8"	AB 060/20
25,0 cm/10"	AB 060/25
30,0 cm/12"	AB 060/30

AA
 AB
 AC
 AD
 AE
 AF
 AK
 AL
 AO
 AP
 AR
 KB
 KI
 KC
 KU
 KYE
 X

AB PINZETTEN FORCEPS PINZAS PINCES PINZE

Anatomische Pinzetten, Chirurgische Pinzetten
 Dressing Forceps, Tissue Forceps
 Pinzas de disección, Pinzas de disección con dientes
 Pincés à dissection, Pincés à griffes
 Pinze anatomiche per dissezione, Pinze chirurgiche a denti di topo

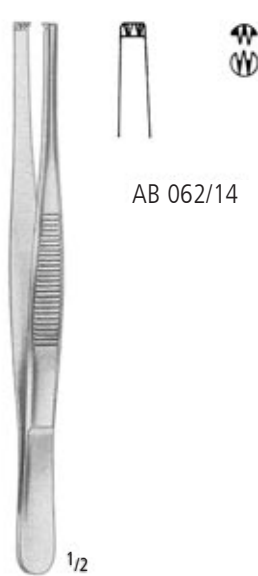

AB 062/14



AB 064/14

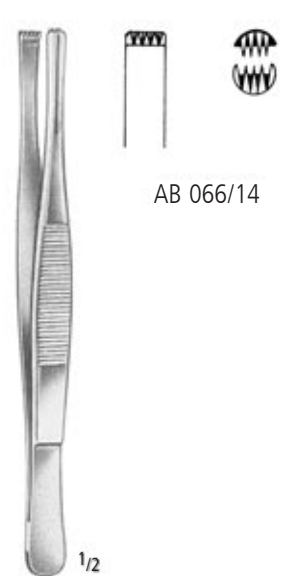

AB 066/14

2:3

3:4

4:5

- 13,0 cm/5"
- 14,5 cm/5³/₄"
- 16,0 cm/6¹/₄"
- 18,0 cm/7"
- 20,0 cm/8"
- 25,0 cm/10"
- 30,0 cm/12"

- AB 062/13
- AB 062/14
- AB 062/16
- AB 062/18
- AB 062/20
- AB 062/25
- AB 062/30

- AB 064/13
- AB 064/14
- AB 064/16

- AB 066/13
- AB 066/14
- AB 066/16

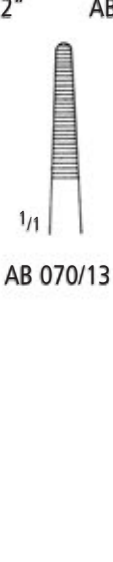

AB 070/13

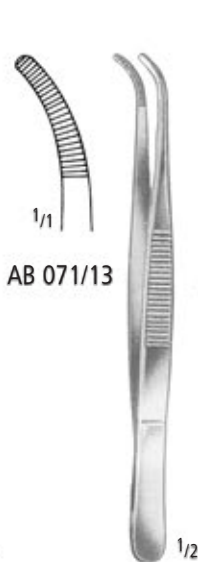

AB 071/13

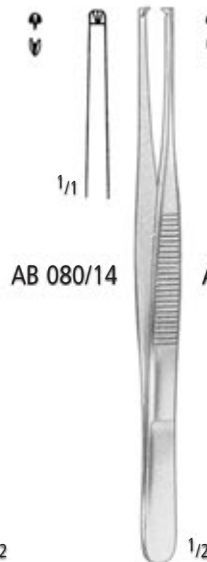

AB 080/14



AB 081/14



AB 083/14



AB 084/14

1:2

1:2

1:2

schmal - narrow - estrechas - étroites - strette

fein - delicate - finas - fines - fine

10,5 cm/4 ¹ / ₄ "	AB 070/10	AB 071/10	AB 080/10	AB 081/10
11,5 cm/4 ¹ / ₂ "	AB 070/11	AB 071/11	AB 080/11	AB 081/11
13,0 cm/5"	AB 070/13	AB 071/13	AB 080/13	AB 081/13
14,5 cm/5 ³ / ₄ "	AB 070/14	AB 071/14	AB 080/14	AB 081/14
16,0 cm/6 ¹ / ₄ "	AB 070/16	AB 071/16	AB 080/16	AB 081/16
18,0 cm/7"	AB 070/18	AB 071/18	AB 080/18	AB 081/18
20,0 cm/8"	AB 070/20	AB 071/20	AB 080/20	AB 081/20
23,0 cm/9"	AB 070/23		AB 080/23	
25,0 cm/10"	AB 070/25	AB 071/25	AB 080/25	AB 081/25
30,0 cm/12"	AB 070/30	AB 071/30	AB 080/30	AB 081/30

AB 083/13	AB 084/13
AB 083/14	AB 084/14

PINZETTEN FORCEPS PINZAS PINCES PINZE

Anatomische Pinzetten, Chirurgische Pinzetten
 Dressing Forceps, Tissue Forceps
 Pinzas de disección, Pinzas de disección con dientes
 Pincers à dissection, Pincers à griffes
 Pinze anatomiche per dissezione, Pinze chirurgiche a denti di topo

MODELL USA

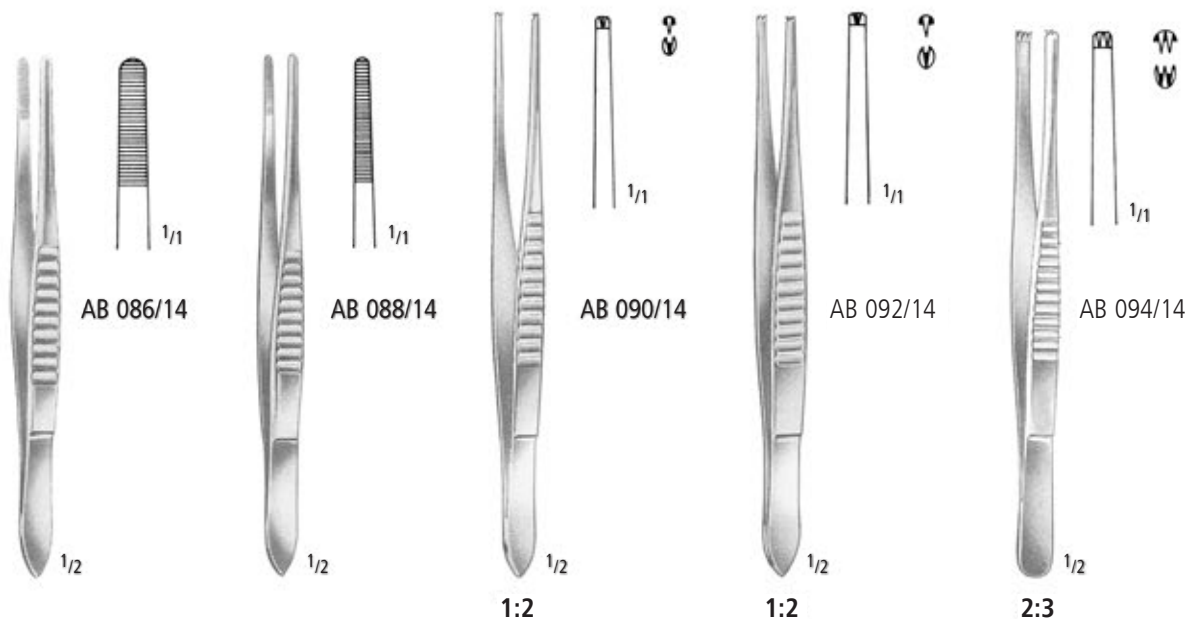

schmal - narrow - estrechas - étroites - strette

- 12,0 cm/4³/₄" AB 086/12
- 13,0 cm/5" AB 086/13
- 14,5 cm/5³/₄" AB 086/14
- 15,5 cm/6" AB 086/15
- 18,0 cm/7" AB 086/18
- 21,0 cm/8¹/₄" AB 086/21
- 25,0 cm/10" AB 086/25
- 31,0 cm/12¹/₄" AB 086/31

- AB 088/12
- AB 088/13
- AB 088/14
- AB 088/15

- AB 090/13
- AB 090/14
- AB 090/15

- AB 092/12
- AB 092/13
- AB 092/14
- AB 092/15
- AB 092/18
- AB 092/21
- AB 092/25
- AB 092/31

- AB 094/12
- AB 094/13
- AB 094/14
- AB 094/15
- AB 094/18
- AB 094/21
- AB 094/25
- AB 094/31

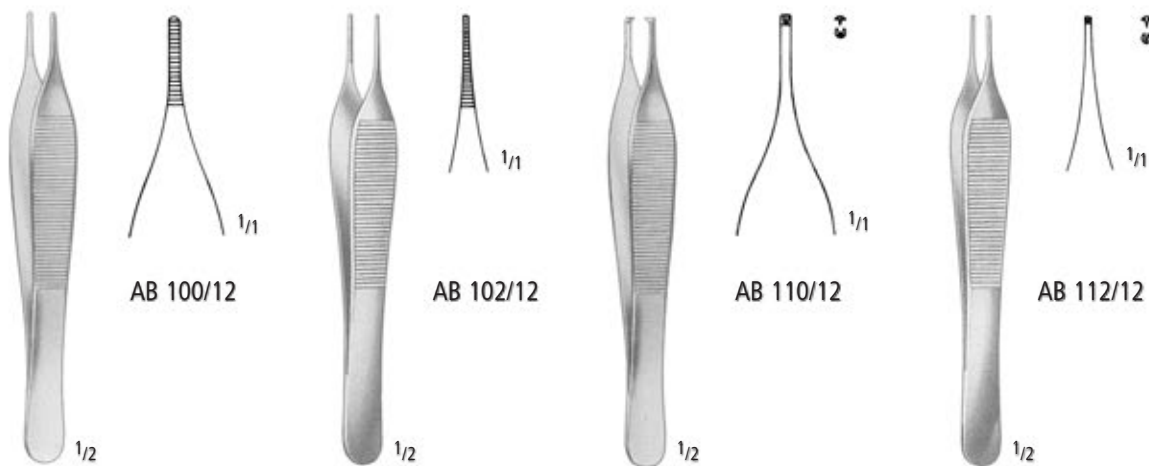

- 12,0 cm/4³/₄"
- 15,0 cm/6"

- ADSON**
 AB 100/12
 AB 100/15

- MICRO-ADSON**
 AB 102/12
 AB 102/15

- ADSON 1:2**
 AB 110/12
 AB 110/15

- MICRO-ADSON 1:2**
 AB 112/12
 AB 112/15

AA
AB
 AC
 AD
 AE
 AF
 AG
 AH
 AI
 AJ
 AK
 AL
 AM
 AN
 AO
 AP
 AQ
 AR
 AS
 AT
 AU
 AV
 AW
 AX

AB PINZETTEN FORCEPS PINZAS PINCES PINZE

Anatomische Pinzetten, Chirurgische Pinzetten
 Dressing Forceps, Tissue Forceps
 Pinzas de disección, Pinzas de disección con dientes
 Pincés à dissection, Pincés à griffes
 Pinze anatomiche per dissezione, Pinze chirurgiche a denti di topo

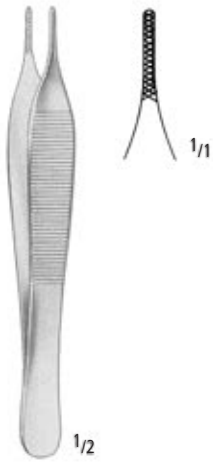

ADSON
 AB 114/12
 12,0 cm/4³/₄"

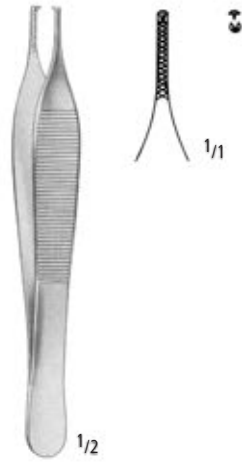

ADSON 1:2
 AB 115/12
 12,0 cm/4³/₄"

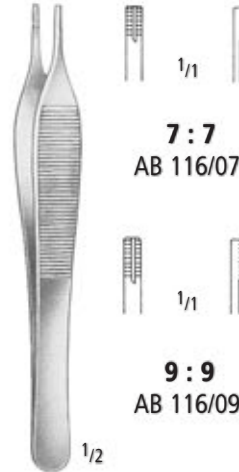

ADSON-BROWN
 12,0 cm/4³/₄"



ADSON-BROWN
 AB 117/09
 12,0 cm/4³/₄"

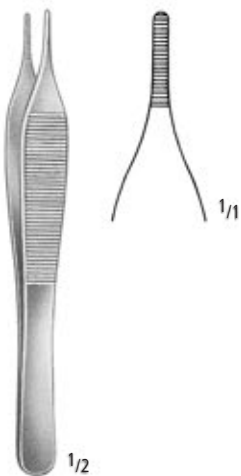

EWALD
 AB 118/01
 12,0 cm/4³/₄"

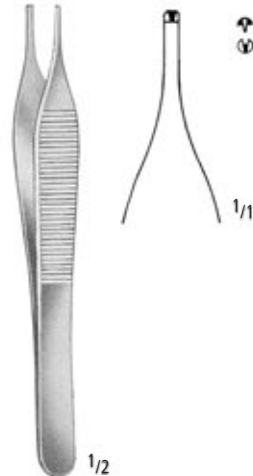

EWALD 1:2
 AB 118/02
 12,0 cm/4³/₄"



McINDOE
 AB 119/15
 15,0 cm/6"



AB 120/12
 AB 120/15

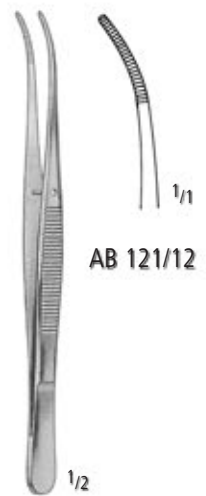

SEMKEN
 12,5 cm/5"
 15,5 cm/6"
 AB 121/12
 AB 121/15

PINZETTEN FORCEPS PINZAS PINCES PINZE

Anatomische Pinzetten, Chirurgische Pinzetten
 Dressing Forceps, Tissue Forceps
 Pinzas de disección, Pinzas de disección con dientes
 Pincers à dissection, Pincers à griffes
 Pinze anatomiche per dissezione, Pinze chirurgiche a denti di topo

AA
AB
 AC
 AD
 AE
 AF
 AG
 AH
 AI
 AJ
 AK
 AL
 AM
 AN
 AO
 AP
 AQ
 AR
 AS
 AT
 AU
 AV
 AW
 AX

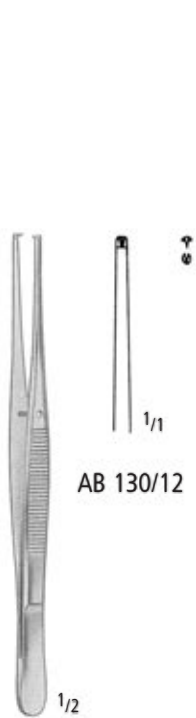

AB 130/12

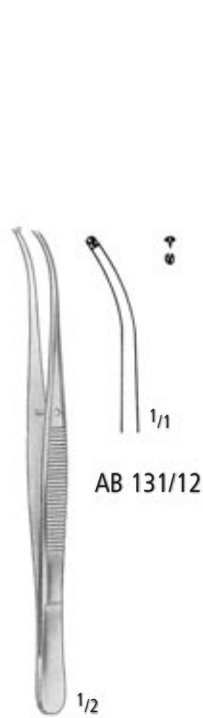

AB 131/12



TAYLOR
 AB 140/17
 17,5 cm/7"



TAYLOR
 AB 141/17
 17,5 cm/7"



TAYLOR
 AB 142/17
 17,5 cm/7"



TAYLOR
 AB 143/17
 17,5 cm/7"

SEMKEN 1:2
 AB 130/12 12,5 cm/5"
 AB 130/15 15,5 cm/6"
 AB 131/12
 AB 131/15



TAYLOR
 1:2
 AB 150/17
 17,5 cm/7"



TAYLOR
 1:2
 AB 151/17
 17,5 cm/7"



TAYLOR
 1:2
 AB 152/17
 17,5 cm/7"



TAYLOR
 1:2
 AB 153/17
 17,5 cm/7"

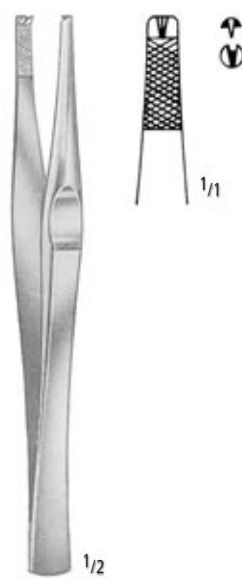

LANE
 1:2
 AB 156/14 14,5 cm/5³/₄"
 AB 156/20 20,0 cm/8"



LANE
 2:3
 AB 158/14
 AB 158/20

AB PINZETTEN FORCEPS PINZAS PINCES PINZE

Anatomische Pinzetten, Chirurgische Pinzetten
 Dressing Forceps, Tissue Forceps
 Pinzas de disección, Pinzas de disección con dientes
 Pincers à dissection, Pincers à griffes
 Pinze anatomiche per dissezione, Pinze chirurgiche a denti di topo

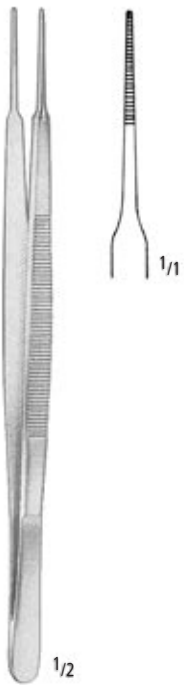

GERALD
 AB 160/18 18,0 cm/7"



GERALD
 AB 161/18



GERALD 1:2
 AB 170/18 18,0 cm/7"



GERALD 1:2
 AB 171/18



CUSHING
 AB 180/17 17,5 cm/7"



CUSHING
 AB 181/17



CUSHING 1:2
 AB 190/17 17,5 cm/7"



CUSHING 1:2
 AB 191/17

PINZETTEN FORCEPS PINZAS PINCES PINZE

Anatomische Pinzetten, Chirurgische Pinzetten
 Dressing Forceps, Tissue Forceps
 Pinzas de disección, Pinzas de disección con dientes
 Pincès à dissection, Pincès à griffes
 Pinze anatomiche per dissezione, Pinze chirurgiche a denti di topo

AA
AB
 AC
 AD
 AE
 AF
 AK
 AL
 AO
 AP
 AR
 KB
 KI
 KC
 KU
 KYE
 X



AB 200/18

POTTS-SMITH

1/2



AB 201/18



AB 210/18

**POTTS-SMITH
 1:2**

1/2



AB 211/18

18,0 cm/7"
 21,0 cm/8 1/4"
 25,0 cm/10"

AB 200/18
 AB 200/21
 AB 200/25

AB 201/18
 AB 201/21
 AB 201/25

AB 210/18
 AB 210/21
 AB 210/25

AB 211/18
 AB 211/21
 AB 211/25



BROPHY

1/2



AB 251/20



**BROPHY
 1:2**

1/2



AB 261/20

20,0 cm/8"

AB 250/20

AB 260/20

AB PINZETTEN FORCEPS PINZAS PINCES PINZE

Anatomische Pinzetten, Chirurgische Pinzetten
 Dressing Forceps, Tissue Forceps
 Pinzas de disección, Pinzas de disección con dientes
 Pincés à dissection, Pincés à griffes
 Pinze anatomiche per dissezione, Pinze chirurgiche a denti di topo

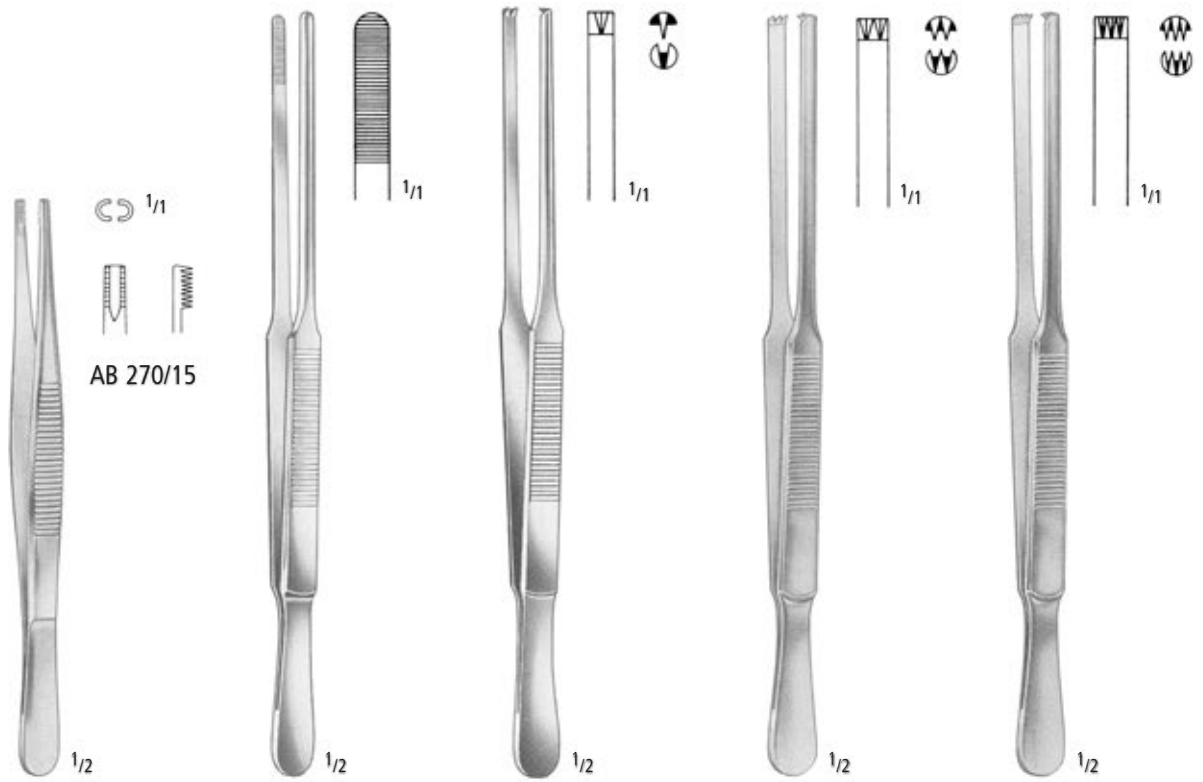

BROWN
 15,0 cm/6"
 20,0 cm/8"
 25,0 cm/10"
 AB 270/15
 AB 270/20
 AB 270/25

DUEHRSSSEN
 AB 290/20

DUEHRSSSEN 1:2
 AB 292/20

DUEHRSSSEN 2:3
 AB 294/20

DUEHRSSSEN 3:4
 AB 296/20

PINZETTEN FORCEPS PINZAS PINCES PINZE

Anatomische Pinzetten, Chirurgische Pinzetten
 Dressing Forceps, Tissue Forceps
 Pinzas de disección, Pinzas de disección con dientes
 Pincers à dissection, Pincers à griffes
 Pinze anatomiche per dissezione, Pinze chirurgiche a denti di topo



WANGENSTEEN
 AB 306/23
 23,0 cm/9"



STILLE-BARRAYA 3:4
 18,0 cm/7"
 20,0 cm/8"
 25,0 cm/10"

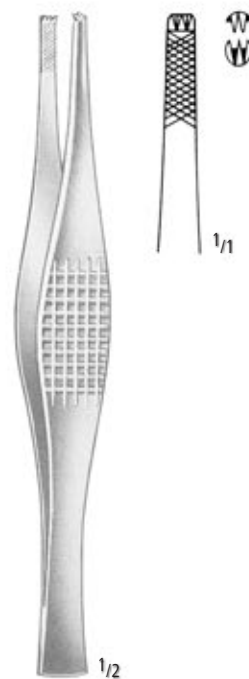

FERRIS-SMITH 2:3
 AB 320/18
 18,0 cm/7"

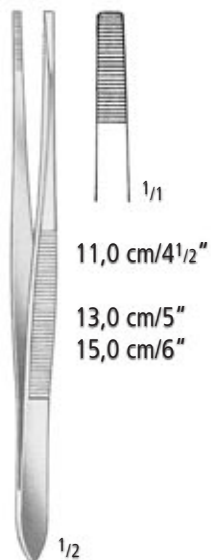

STILLE
 AB 370/11
 AB 370/13
 AB 370/15



STILLE 1:2
 AB 380/15
 15,0 cm/6"



STILLE 2:3
 AB 382/15
 15,0 cm/6"

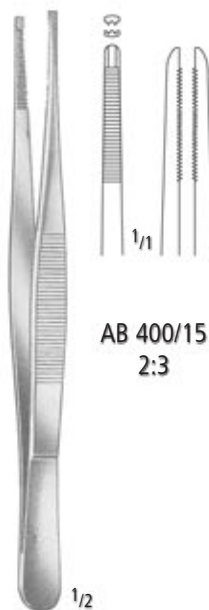

ADLERKREUTZ

15,0 cm/6"
 20,0 cm/8"
 25,0 cm/10"

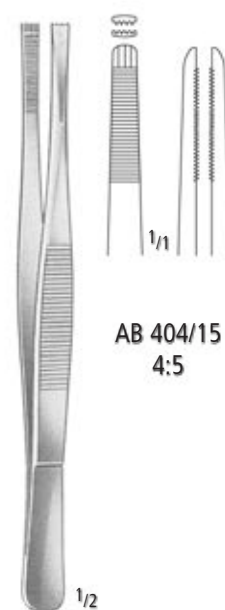

AB 400/15
 2:3
 AB 404/15
 4:5
 AB 404/15
 AB 404/20
 AB 404/25

AA
 AB
 AC
 AD
 AE
 AF
 AK
 AL
 AO
 AP
 AR
 KB
 KI
 KC
 KU
 KYE
 X

AB PINZETTEN FORCEPS PINZAS PINCES PINZE

Fasspinzetten
 Grasping Forceps
 Pinzas para coger
 Pincas pour saisir les tissus
 Pinze per afferrare tessuti

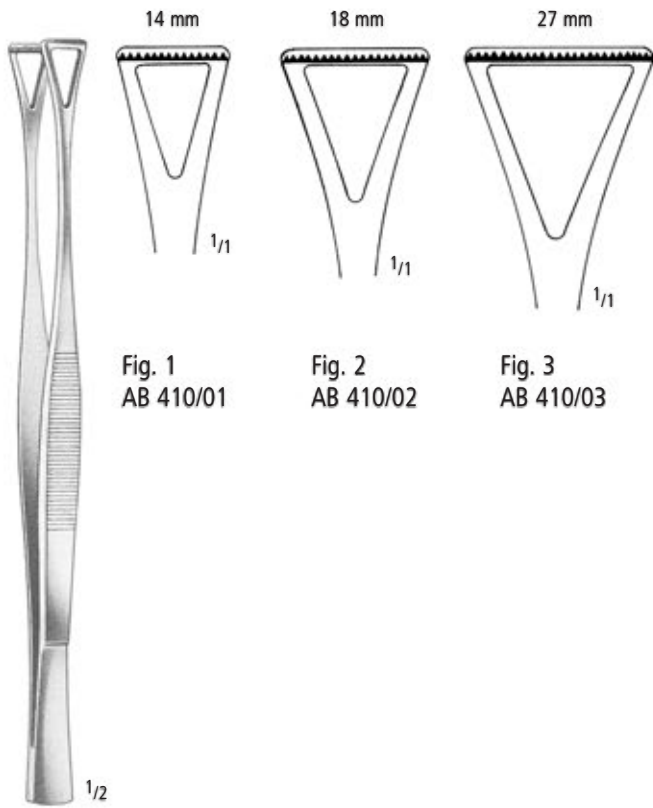
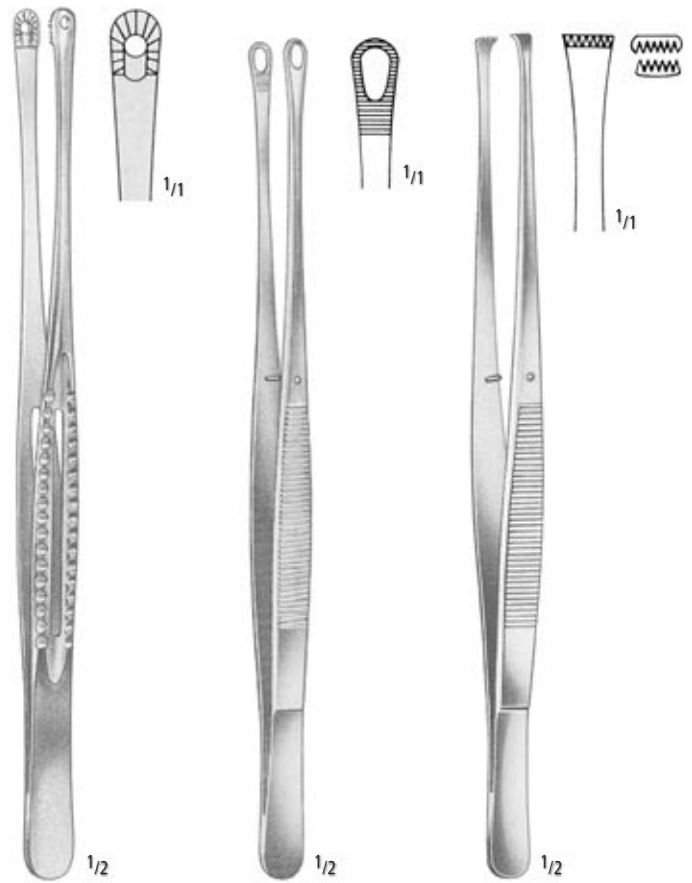

Fig. 1
 AB 410/01

Fig. 2
 AB 410/02

Fig. 3
 AB 410/03

COLLIN-DUVAL
 20,0 cm/8"



MAYO-RUSS.
 AB 414/23
 23,0 cm/9"

SINGLEY-TUTTLE
 AB 416/23
 23,0 cm/9"

NELSON
 AB 418/23
 23,0 cm/9"

PINZETTEN FORCEPS PINZAS PINCES PINZE

Chirurgische Pinzetten, Fasspinzetten
 Tissue Forceps, Grasping Forceps
 Pinzas de disección con dientes, Pinzas para coger
 Pincés à griffes, Pincés pour saisir les tissus
 Pinze chirurgiche a denti di topo, Pinze per afferrare tessuti



GILLIES 1:2
 AB 430/15
 15,0 cm/6"



WAUGH 1:2
 AB 434/20
 20,5 cm/8"



AB 440/10
 10,5 cm/4 1/4"

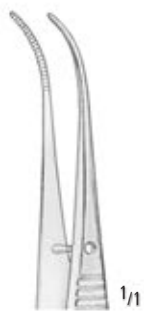

AB 441/10

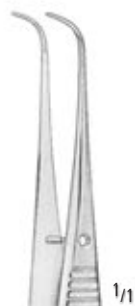

AB 443/10



1:2
AB 444/10
 10,5 cm/4 1/4"



AB 445/10



AB 447/10

AA
AB
 AC
 AD
 AE
 AF
 AK
 AL
 AO
 AP
 AR
 KB
 KI
 KC
 KU
 KYE
 X

AB PINZETTEN FORCEPS PINZAS PINCES PINZE

Chirurgische Pinzetten, Fasspinzetten
 Tissue Forceps, Grasping Forceps
 Pinzas de disección con dientes, Pinzas para coger
 Pincès à griffes, Pincès pour saisir les tissus
 Pinze chirurgiche a denti di topo, Pinze per afferrare tessuti



AB 480/15

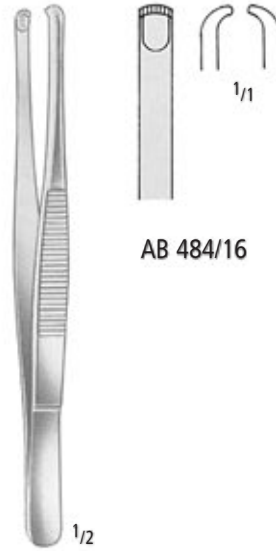

AB 484/16

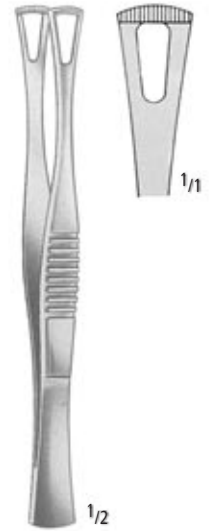

DUVAL
 AB 486/14
 14,5 cm/5³/₄"

RUSS. MODELL
 15,0 cm/6"
 20,0 cm/8"
 25,0 cm/10"
 AB 480/15
 AB 480/20
 AB 480/25

DURANTE
 14,5 cm/5³/₄"
 16,0 cm/6¹/₄"
 20,0 cm/8"
 AB 484/14
 AB 484/16
 AB 484/20



BONNEY 1:2
 AB 490/18
 18,0 cm/7"

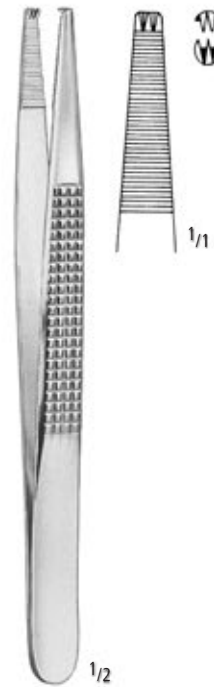

BONNEY 2:3
 AB 492/18
 18,0 cm/7"

PINZETTEN FORCEPS PINZAS PINCES PINZE

Fasspinzetten
Grasping Forceps
Pinzas para coger
Pincers pour saisir les tissus
Pinze per afferrare tessuti



AB 506/01
Ø 3,0 mm

AB 506/02
Ø 3,0 mm

SAMII
24,0 cm/9 1/2"

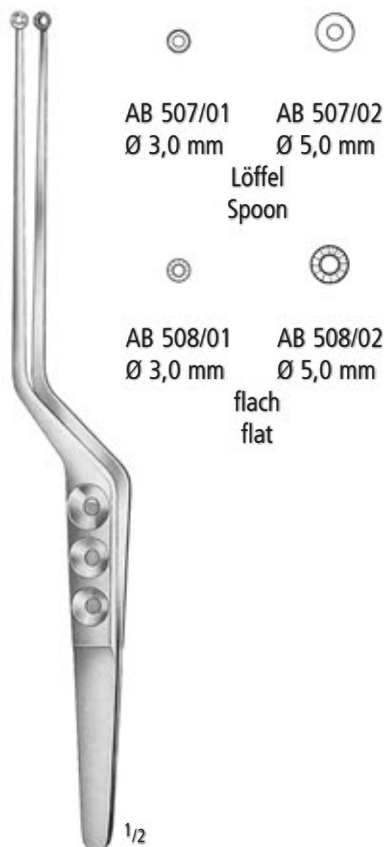

AB 507/01
Ø 3,0 mm

AB 507/02
Ø 5,0 mm

Löffel
Spoon

AB 508/01
Ø 3,0 mm

AB 508/02
Ø 5,0 mm

flach
flat

22,0 cm/8 3/4"



AB 509/01
Ø 3,0 mm

AB 509/02
Ø 5,0 mm

Kürette
Curette

HEIFETZ
22,0 cm/8 3/4"



HUNT
AB 510/20
20,0 cm/8"



16,0 cm/6 1/4"
18,0 cm/7"
20,0 cm/8"
22,0 cm/8 3/4"
24,0 cm/9 1/2"

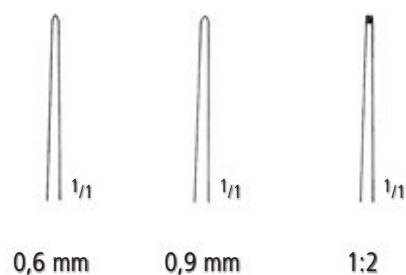

0,6 mm

0,9 mm

1:2

AB 515/16

AB 515/18

AB 515/20

AB 515/22

AB 515/24

AB 516/16

AB 516/18

AB 516/20

AB 516/22

AB 516/24

AB 517/16

AB 517/18

AB 517/20

AA
AB
AC
AD
AE
AF
AK
AL
AO
AP
AR
KB
KI
KC
KU
KYE
X

AB PINZETTEN FORCEPS PINZAS PINCES PINZE

Mikro-Pinzetten, Knüpfpinzetten mit Plateau
 Micro Forceps, Suture Tying Forceps with platform
 Micro-Pinzas, Pinzas de ligadura con plataforma
 Micro-Pinces, Pinces à ligature avec plate-forme
 Micro-Pinze, Pinze per ligature con piattaforma

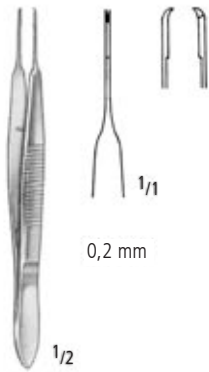

1:2
 AB 530/09
 9,5 cm/3³/₄"

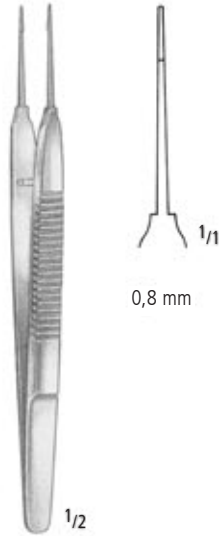

AUSTIN
 AB 532/14
 14,0 cm/5¹/₂"

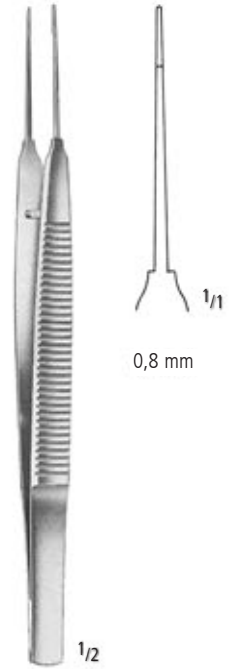

AUSTIN
 AB 532/18
 18,0 cm/7"

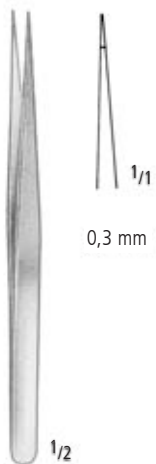

AB 534/12
 12,0 cm/4³/₄"



VISE
 AB 534/13
 13,5 cm/5¹/₄"

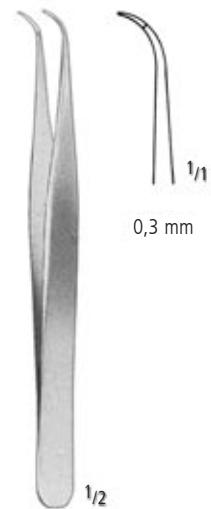

VISE
 AB 535/13
 13,5 cm/5¹/₄"

PINZETTEN FORCEPS PINZAS PINCES PINZE

Mikro-Pinzetten, Knüpfpinzetten mit Plateau, Gefäßdilator
 Micro Forceps, Suture Tying Forceps with platform, Vessel Dilator
 Micro-Pinzas, Pinzas de ligadura con plataforma, Dilatador para vasos
 Micro-Pinces, Pinces à ligature avec plate-forme, Dilatateur pour vaisseaux
 Micro-Pinze, Pinze per ligature con piattaforma, Dilatatore per vasi



AB 536/14
 14,0 cm/5 1/2"



AB 538/14 1:2
 14,0 cm/5 1/2"



AB 540/14 1:2
 14,0 cm/5 1/2"

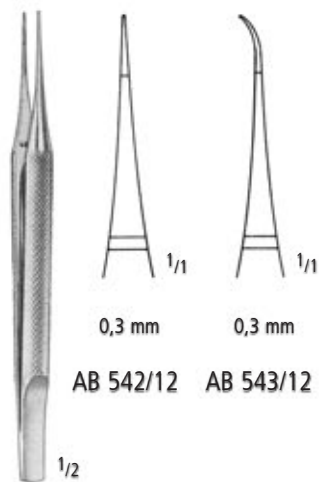

12,0 cm/4 3/4" AB 542/12 AB 543/12
 15,0 cm/6" AB 542/15 AB 543/15

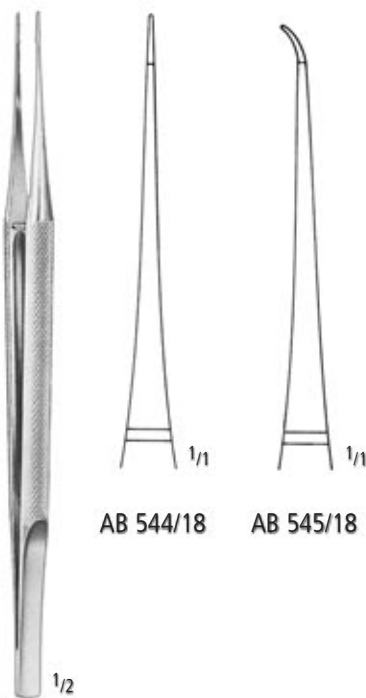

18,0 cm/7"

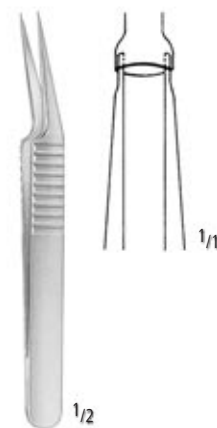

AB 546/11
 11,0 cm/4 1/3"

AA
AB
 AC
 AD
 AE
 AF
 AK
 AL
 AO
 AP
 AR
 KB
 KI
 KC
 KU
 KYE
 X

AB PINZETTEN FORCEPS PINZAS PINCES PINZE

Atraumatische Pinzetten
 Non-traumatic Vascular Tissue Forceps
 Pinzas Atrauma
 Pincas Atrauma
 Pinze Atrauma

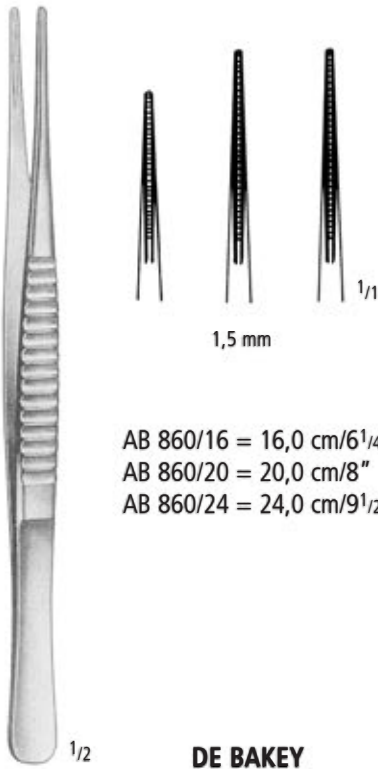

1,5 mm

AB 860/16 = 16,0 cm/6¹/₄"
 AB 860/20 = 20,0 cm/8"
 AB 860/24 = 24,0 cm/9¹/₂"

DE BAKAY

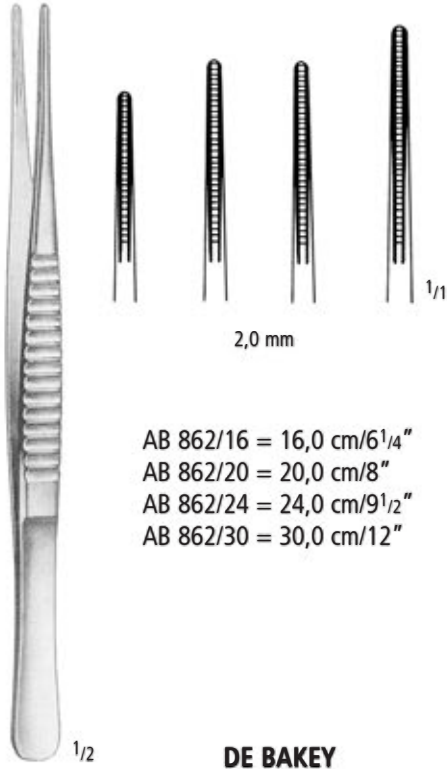

2,0 mm

AB 862/16 = 16,0 cm/6¹/₄"
 AB 862/20 = 20,0 cm/8"
 AB 862/24 = 24,0 cm/9¹/₂"
 AB 862/30 = 30,0 cm/12"

DE BAKAY

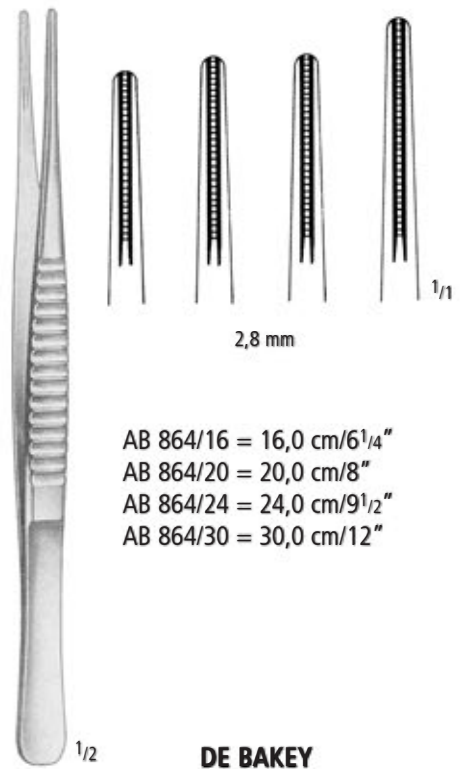

2,8 mm

AB 864/16 = 16,0 cm/6¹/₄"
 AB 864/20 = 20,0 cm/8"
 AB 864/24 = 24,0 cm/9¹/₂"
 AB 864/30 = 30,0 cm/12"

DE BAKAY

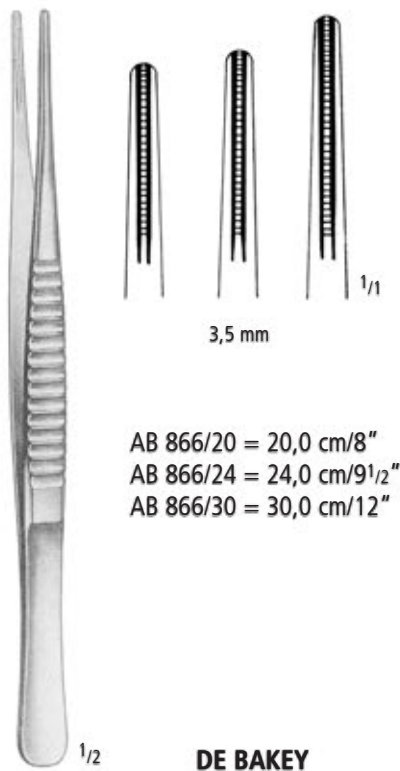

3,5 mm

AB 866/20 = 20,0 cm/8"
 AB 866/24 = 24,0 cm/9¹/₂"
 AB 866/30 = 30,0 cm/12"

DE BAKAY

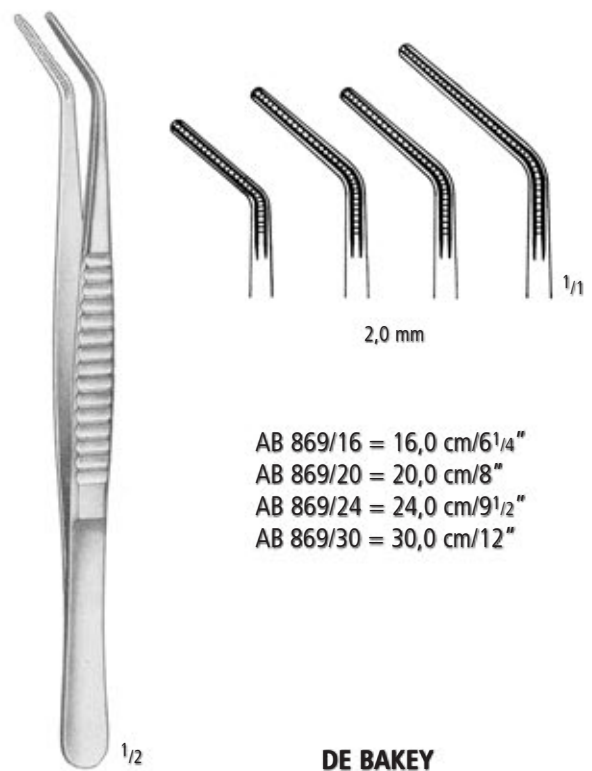

2,0 mm

AB 869/16 = 16,0 cm/6¹/₄"
 AB 869/20 = 20,0 cm/8"
 AB 869/24 = 24,0 cm/9¹/₂"
 AB 869/30 = 30,0 cm/12"

DE BAKAY

PINZETTEN FORCEPS PINZAS PINCES PINZE

Pinzetten mit Hartmetalleinsätzen
 Dissecting Forceps with Tungsten Carbide Inserts
 Pinzas de disección con bocas de carburo de tungsteno
 Pincés à dissection avec mors en carbure de tungstène
 Pinze per dissezione con punte di carburo di tungsteno

AA
 AB
 AC
 AD
 AE
 AF
 AK
 AL
 AO
 AP
 AR
 KB
 KI
 KC
 KU
 KYE
 X

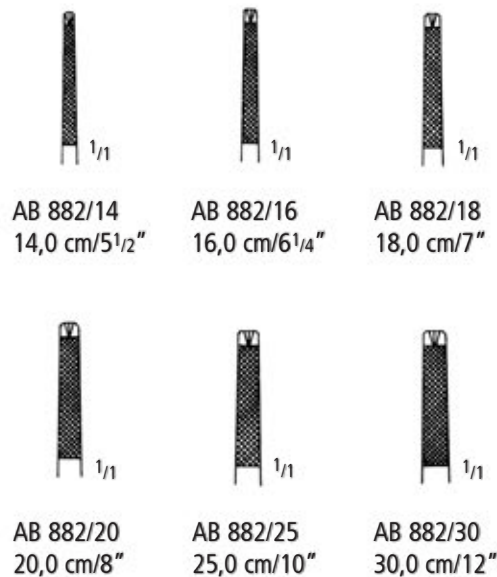
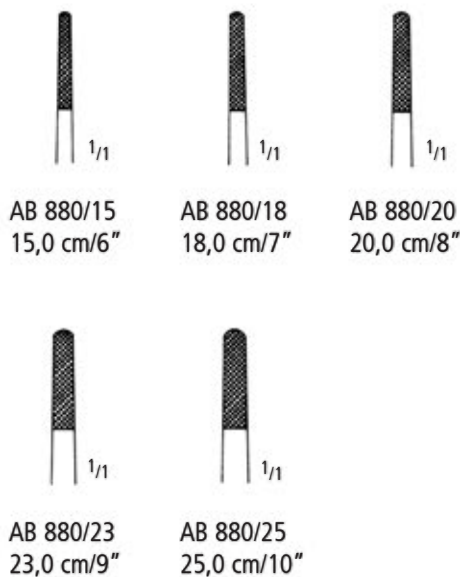

AB PINZETTEN FORCEPS PINZAS PINCES PINZE

Pinzetten mit Hartmetalleinsätzen
 Dissecting Forceps with Tungsten Carbide Inserts
 Pinzas de disección con bocas de carburo de tungsteno
 Pincas à dissection avec mors en carbure de tungstène
 Pinze per dissezione con punte di carburo di tungsteno

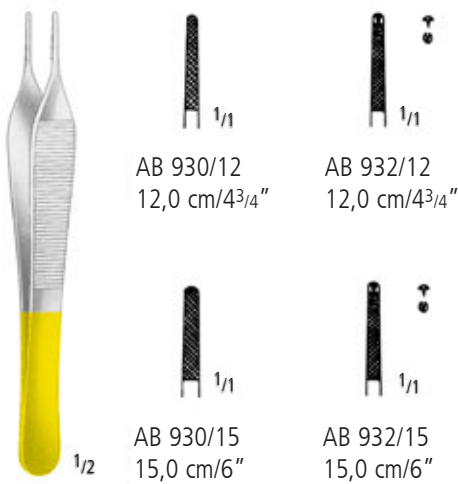

ADSON

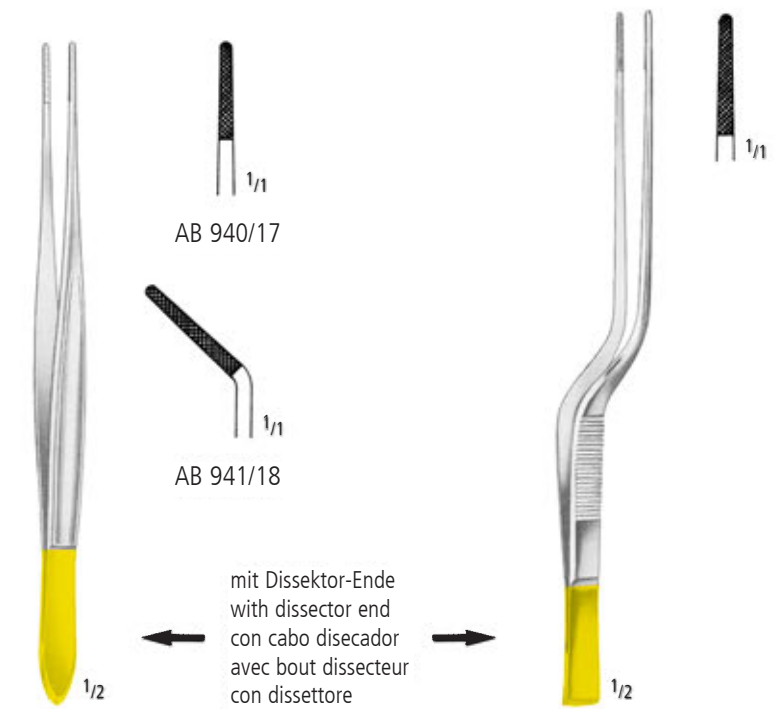

CUSHING
17,5 cm/7"

CUSHING-TAYLOR
AB 943/18
18,0 cm/7"

PINZETTEN FORCEPS PINZAS PINCES PINZE

Pinzetten mit Hartmetalleinsätzen
 Dissecting Forceps with Tungsten Carbide Inserts
 Pinzas de disección con bocas de carburo de tungsteno
 Pincès à dissection avec mors en carbure de tungstène
 Pinze per dissezione con punte di carburo di tungsteno

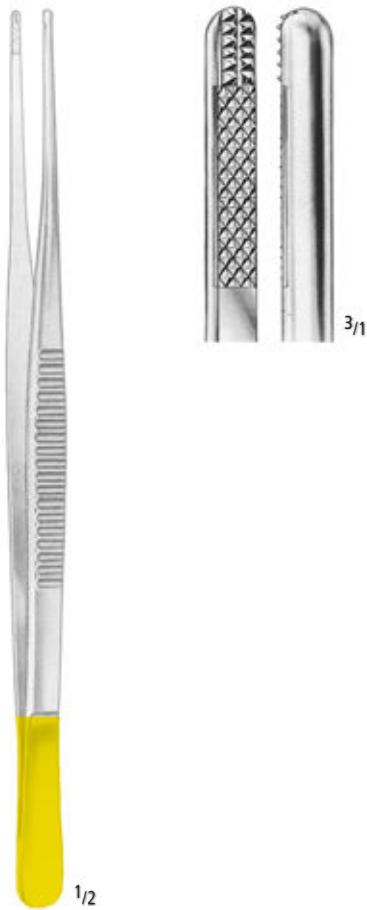

DE BAKY
 16,0 cm/6 1/4"
 20,0 cm/8"
 24,0 cm/9 1/2"

1,5 mm	2,0 mm
AB 944/16	AB 946/16
AB 944/20	AB 946/20
AB 944/24	AB 946/24



BONNEY 1:2
 AB 948/18
 18,0 cm/7"



WANGENSTEEN

AB 950/15
 15,0 cm/6"

AB 950/23
 23,0 cm/9"

AA
 AB
 AC
 AD
 AE
 AF
 AK
 AL
 AO
 AP
 AR
 KB
 KI
 KC
 KU
 KYE
 X

SCHEREN
SCISSORS
TIJERAS
CISEAUX
FORBICI

AC

nopa[®] instruments

Weitere Scheren finden Sie in unserem Katalog „Allgemeines Instrumentarium“ in Gruppe AC.

For further scissors kindly refer to our catalogue „General Instruments“, section AC.

Para tijeras adicionales, por favor consulte nuestro catálogo de „Instrumental de uso general“, grupo AC.

Pour des ciseaux supplémentaires, consultez notre catalogue „Instrumentation Generale“, section AC.

Per gli altri forbici, consultare il nostro catalogo „Strumentazione Generale“, gruppo AC.



nopa® SC
SUPER CUT



Besonderheit:

nopa Super Cut Scheren haben eine rasierklingenscharfe Schneide, kombiniert mit einer mikrogezahnten Schneide.

>> Diese Scheren sind durch schwarze Ringe gekennzeichnet.

Features:

nopa Super Cut scissors have a razor-like edge combined with one micro serrated blade.

>> Black rings for easy identification.

Verfügbare Modelle / Available Patterns

Im Katalog durch * markiert. / Marked in catalog with *.

AC 020/13 SC STANDARD OPER.SCS STR. SH/BL 13,0 CM SC
AC 020/14 SC STANDARD OPER.SCS STR. SH/BL 14,0 CM SC
AC 021/13 SC STANDARD OPER.SCS CVD. SH/BL 13,0 CM SC
AC 021/14 SC STANDARD OPER.SCS CVD. SH/BL 14,0 CM SC
AC 070/14 SC MAYO OPER. SCS STR. BL/BL 14,5 CM SC
AC 070/17 SC MAYO OPER. SCS STR. BL/BL 17,0 CM SC
AC 070/23 SC MAYO OPER. SCS STR. BL/BL 23,0 CM SC
AC 071/14 SC MAYO OPER. SCS CVD. BL/BL 14,5 CM SC
AC 071/17 SC MAYO OPER. SCS CVD. BL/BL 17,0 CM SC
AC 071/23 SC MAYO OPER. SCS CVD. BL/BL 23,0 CM SC
AC 073/17 SC MAYO-STILLE OPER. SCS CVD. BL/BL 17,0 CM SC
AC 100/14 SC METZENBAUM SCS STR. BL/BL 14,0 CM SC
AC 101/14 SC METZENBAUM SCS CVD. BL/BL 14,0 CM SC
AC 110/18 SC METZENBAUM-NELSON SCS STR.BL/BL 18,0 CM SC
AC 110/20 SC METZENBAUM-NELSON SCS STR.BL/BL 20,0 CM SC
AC 110/23 SC METZENBAUM-NELSON SCS STR.BL/BL 23,0 CM SC
AC 111/18 SC METZENBAUM-NELSON SCS CVD.BL/BL 18,0 CM SC
AC 111/20 SC METZENBAUM-NELSON SCS CVD.BL/BL 20,0 CM SC
AC 111/23 SC METZENBAUM-NELSON SCS CVD.BL/BL 23,0 CM SC
AC 141/14 SC METZENBAUM-DELICATE SCS BL/BL CVD. 14,5 CM SC
AC 151/18 SC METZENBAUM-DELICATE SCS BL/BL CVD. 18,0 CM SC
AC 214/15 SC REYNOLDS DISS. SCS STR. SH/SH 15,0 CM SC
AC 214/18 SC REYNOLDS DISS. SCS CVD. SH/SH 18,0 CM SC
AC 450/11 SC IRIS SCS STR. SH/SH 11,5 CM SC
AC 451/11 SC IRIS SCS CVD. SH/SH 11,5 CM SC
AC 460/11 SC STRABISMUS SCS STR. BL/BL 11,5 CM SC
AC 461/11 SC STRABISMUS SCS CVD. BL/BL 11,5 CM SC
AC 476/11 SC STEVENS TENOTOMY SCS STR. BL/BL 11,5 CM SC
AC 477/11 SC STEVENS TENOTOMY SCS CVD. BL/BL 11,5 CM SC

Chirurgische Scheren
Operating Scissors
Tijeras para cirugía
Ciseaux à chirurgie
Forbici per chirurgia



Original 13,0 cm

**STANDARD
STANDARD**

Fig.1
gerade
straight
rectas
droits
rette

- | | |
|-----------|---|
| AC 010/10 | 10,5 cm/4 ¹ / ₄ " |
| AC 010/11 | 11,5 cm/4 ¹ / ₂ " |
| AC 010/13 | 13,0 cm/5" |
| AC 010/14 | 14,5 cm/5 ³ / ₄ " |
| AC 010/15 | 15,5 cm/6" |
| AC 010/16 | 16,5 cm/6 ¹ / ₂ " |
| AC 010/17 | 17,5 cm/7" |
| AC 010/18 | 18,5 cm/7 ¹ / ₃ " |
| AC 010/20 | 20,0 cm/8" |

Fig.1
gebogen
curved
curvas
courbes
curve



Original 13,0 cm



Original 14,5 cm

**STANDARD
STANDARD**

Fig.2
gerade
straight
rectas
droits
rette

- | | |
|------------|---|
| AC 020/10 | 10,5 cm/4 ¹ / ₄ " |
| AC 020/11 | 11,5 cm/4 ¹ / ₂ " |
| AC 020/13* | 13,0 cm/5" |
| AC 020/14* | 14,5 cm/5 ³ / ₄ " |
| AC 020/15 | 15,5 cm/6" |
| AC 020/16 | 16,5 cm/6 ¹ / ₂ " |
| AC 020/17 | 17,5 cm/7" |
| AC 020/18 | 18,5 cm/7 ¹ / ₃ " |
| AC 020/20 | 20,0 cm/8" |

Fig.2
gebogen
curved
curvas
courbes
curve



Original 14,5 cm



Original 16,5 cm

**STANDARD
STANDARD**

Fig.3
gerade
straight
rectas
droits
rette

- | | |
|-----------|---|
| AC 030/10 | 10,5 cm/4 ¹ / ₄ " |
| AC 030/11 | 11,5 cm/4 ¹ / ₂ " |
| AC 030/13 | 13,0 cm/5" |
| AC 030/14 | 14,5 cm/5 ³ / ₄ " |
| AC 030/15 | 15,5 cm/6" |
| AC 030/16 | 16,5 cm/6 ¹ / ₂ " |
| AC 030/17 | 17,5 cm/7" |
| AC 030/18 | 18,5 cm/7 ¹ / ₃ " |
| AC 030/20 | 20,0 cm/8" |

Fig.3
gebogen
curved
curvas
courbes
curve



Original 16,5 cm

SCHEREN SCISSORS TIJERAS CISEAUX FORBICI

Chirurgische Scheren
Operating Scissors
Tijeras para cirugía
Ciseaux à chirurgie
Forbici per chirurgia



Original 13,0 cm



GRAZIL

Fig.1
gerade
straight
rectas
droits
rette

AC 040/13
AC 040/14

13,0 cm/5"
14,5 cm/5³/₄"

Original 13,0 cm



GRAZIL

Fig. 1
gebogen
curved
curvas
courbes
curve

AC 041/13
AC 041/14



Original 14,5 cm



GRAZIL

Fig.2
gerade
straight
rectas
droits
rette

AC 042/13
AC 042/14

13,0 cm/5"
14,5 cm/5³/₄"

Original 14,5 cm



GRAZIL

Fig. 2
gebogen
curved
curvas
courbes
curve

AC 043/13
AC 043/14



Original 14,5 cm



GRAZIL

Fig.3
gerade
straight
rectas
droits
rette

AC 046/13
AC 046/14

13,0 cm/5"
14,5 cm/5³/₄"

Original 14,5 cm



GRAZIL

Fig. 3
gebogen
curved
curvas
courbes
curve

AC 047/13
AC 047/14



AA
AB
AC
AD
AE
AF
AK
AL
AO
AP
AR
KB
KI
KC
KU
KYE
X

AC SCHEREN SCISSORS TIJERAS CISEAUX FORBICI

Chirurgische Scheren
Operating Scissors
Tijeras para cirugía
Ciseaux à chirurgie
Forbici per chirurgia



Inzisionsscheren
Incision Scissors
Tijeras para incision
Ciseaux à incision
Forbici per incisioni

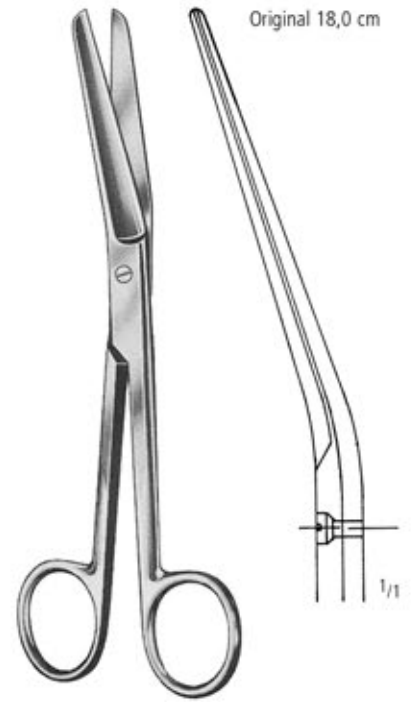

AC 052/13 = 13,0 cm/5"
AC 052/14 = 14,5 cm/5³/₄"

AC 054/15
15,5 cm/6"

RICHTER
AC 056/14
14,5 cm/5³/₄"

FERGUSSON
AC 058/16 = 16,5 cm/6¹/₂"
AC 058/18 = 18,0 cm/7"

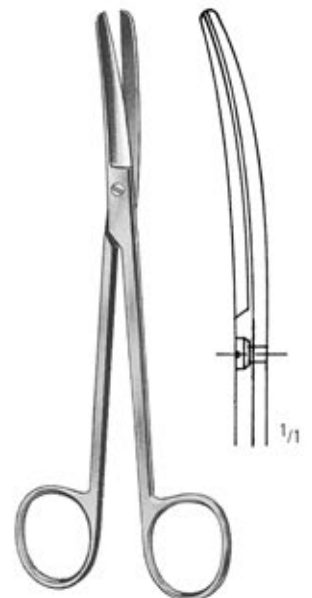
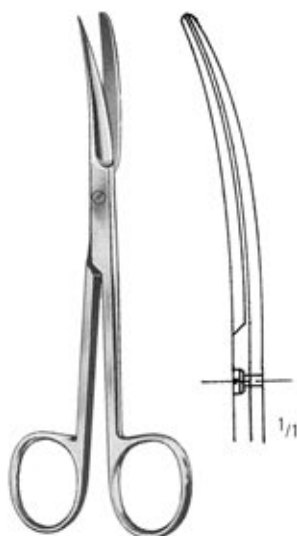

DEAVER
AC 060/14 14,0 cm/5¹/₂"

AC 061/14

AC 062/15

MIXTER
15,5 cm/6"

AC 063/15

SCHEREN SCISSORS TIJERAS CISEAUX FORBICI

Chirurgische und Gynäkologische Scheren
 Operating and Gynecological Scissors
 Tijeras para cirugía y ginecología
 Ciseaux à chirurgie et à gynécologie
 Forbici per chirurgia e ginecologia

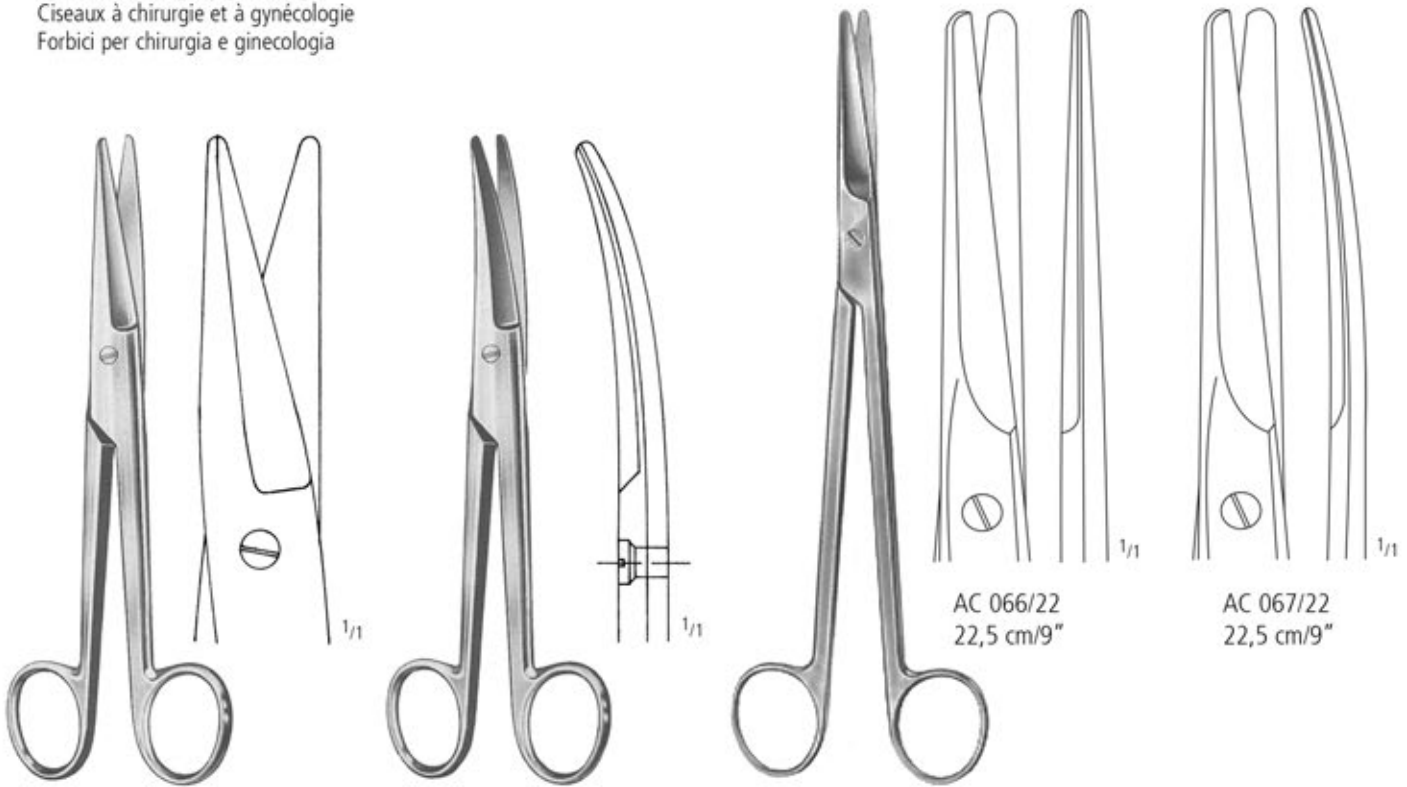

MAYO-NOBLE

AC 064/17

17,0 cm/6³/₄"

AC 065/17

MAYO-HARRINGTON

AC 066/22
22,5 cm/9"

AC 067/22
22,5 cm/9"



MAYO

MAYO-STILLE

14,5 cm/5 ³ / ₄ "	AC 070/14*	AC 071/14*		
15,0 cm/6"			AC 072/15	AC 073/15
17,0 cm/6 ³ / ₄ "	AC 070/17*	AC 071/17*	AC 072/17	AC 073/17*
19,5 cm/7 ³ / ₄ "			AC 072/19	AC 073/19
21,0 cm/8 ¹ / ₄ "			AC 072/21	AC 073/21
23,0 cm/9"	AC 070/23*	AC 071/23*		
28,0 cm/11"	AC 070/28	AC 071/28		

* Auch erhältlich als SC * Also available as SC

AA
AB
AC
AD
AE
AF
AG
AH
AI
AJ
AK
AL
AM
AN
AO
AP
AQ
AR
AS
AT
AU
AV
AW
AX
AY
AZ

AC SCHEREN SCISSORS TIJERAS CISEAUX FORBICI

Gynäkologische und Bauchdecken-Scheren
 Gynecological and Abdominal Scissors
 Tijeras para ginecología y Tijeras abdominales
 Ciseaux à gynécologie et Ciseaux abdominaux
 Forbici per ginecologia e Forbici addominali



DOYEN
 AC 080/16
 16,0 cm/6¹/₄"

DOYEN
 AC 082/16
 16,0 cm/6¹/₄"

DOYEN
 AC 083/16
 16,0 cm/6¹/₄"

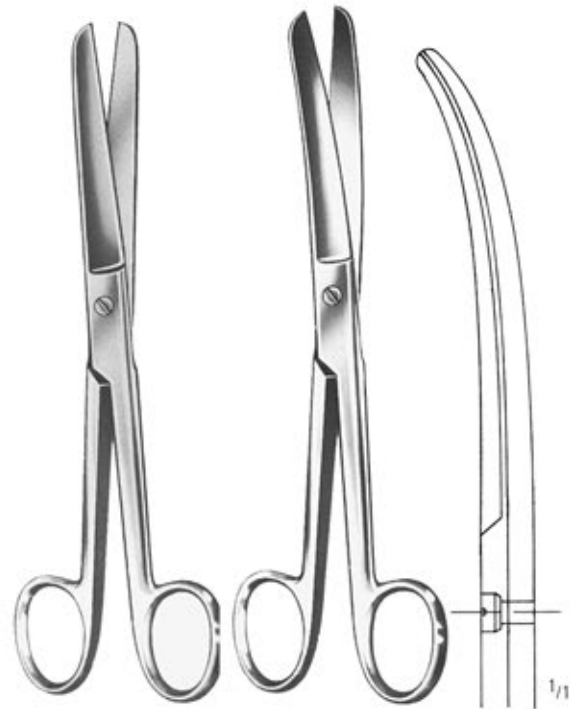

DOYEN
 AC 084/18
 17,5 cm/7"

DOYEN
 AC 085/18
 17,5 cm/7"

Fistelscheren
 Fistula Scissors
 Tijeras para fistulas
 Ciseaux pour fistules
 Forbici per fistole



AC 086/16
 AC 086/18

KELLY
 16,0 cm/6¹/₄"
 18,0 cm/7"

AC 087/16
 AC 087/18

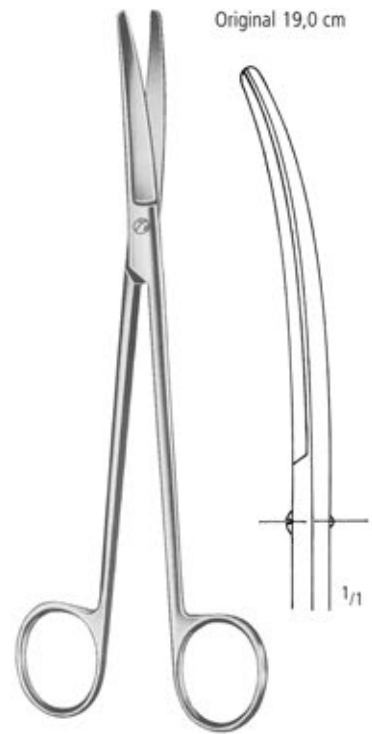

WERTHEIM
 14,5 cm/5³/₄"
 19,5 cm/7³/₄"
 22,5 cm/9"

AC 089/14
 AC 089/19
 AC 089/22

SCHEREN SCISSORS TIJERAS CISEAUX FORBICI

Gynäkologische Scheren
Gynecological Scissors
Tijeras para ginecología
Ciseaux à gynécologie
Forbici per ginecologia



20,0 cm/8"
23,0 cm/9" AC 090/20
AC 090/23



AC 092/20
AC 092/23

SIMS

gerade
straight
rectas
droits
rette



AC 094/20
AC 094/23



AC 091/20
AC 091/23



Original 20,0 cm



AC 093/20
AC 093/23

SIMS

gebogen
curved
curvas
courbes
curve



AC 095/20
AC 095/23



DUBOIS
AC 096/27
27,0 cm/10³/₄"

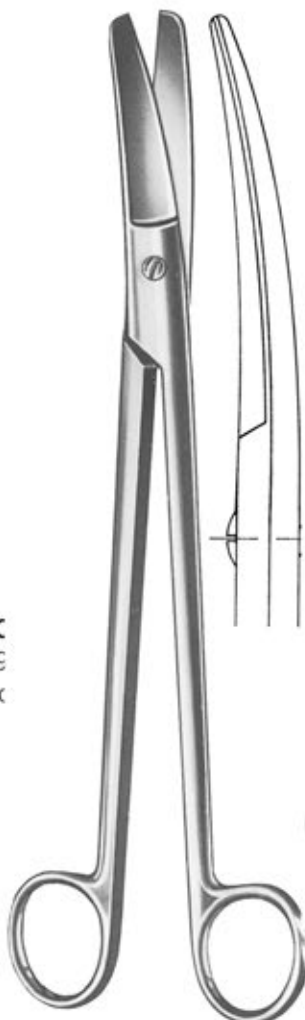

DUBC
AC 09
27,0 c

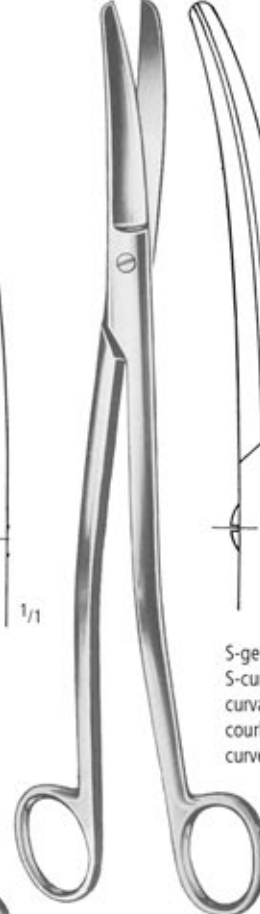

SIEBOLD
AC 098/24
24,0 cm/9¹/₂"



S-gebogen
S-curved
curva forma S
courbes en S
curve in S

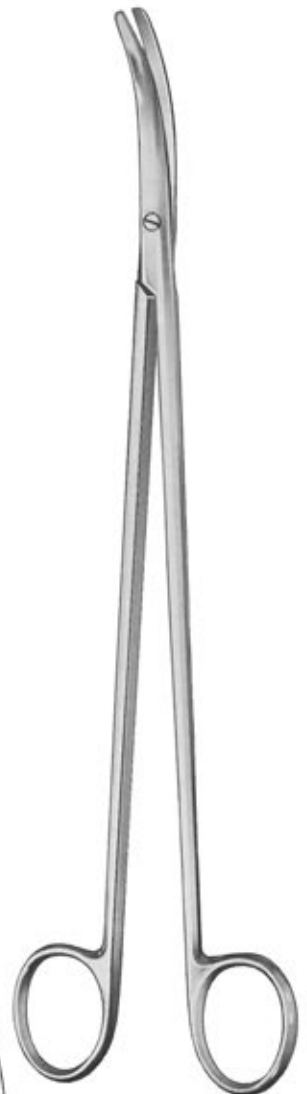

CARDINALE
AC 099/28
28,0 cm/11"

AA
AB
AC
AD
AE
AF
AK
AL
AO
AP
AR
KB
KI
KC
KU
KYE
X

AC SCHEREN SCISSORS TIJERAS CISEAUX FORBICI

Präparierscheren
Dissecting Scissors
Tijeras para preparaciones
Ciseaux à dissection
Forbici per preparazioni

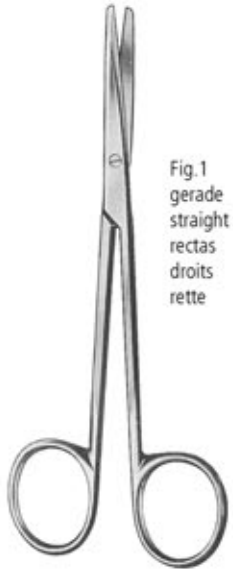

Fig. 1
gerade
straight
rectas
droits
rette

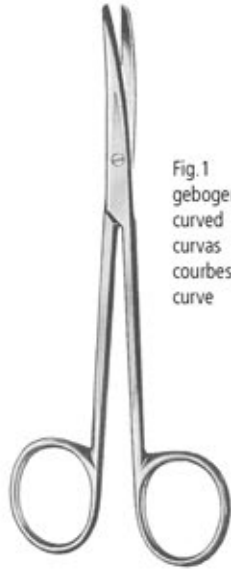

Fig. 1
gebogen
curved
curvas
courbes
curve



1/1

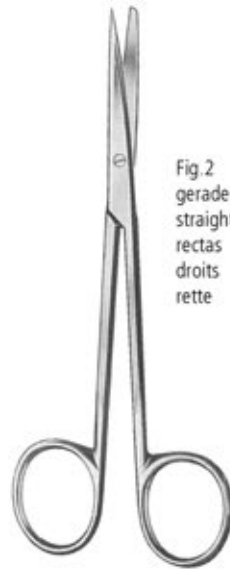

Fig. 2
gerade
straight
rectas
droits
rette

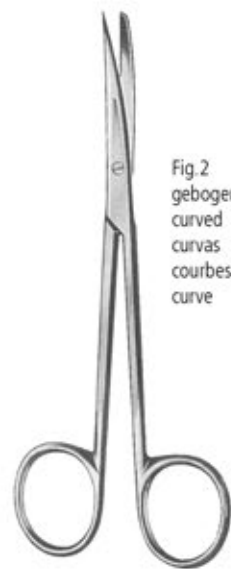

Fig. 2
gebogen
curved
curvas
courbes
curve



1/1

METZENBAUM

AC 100/14*
14,5 cm/5³/₄"

AC 101/14*
14,5 cm/5³/₄"

METZENBAUM

AC 102/14
14,5 cm/5³/₄"

AC 103/14
14,5 cm/5³/₄"

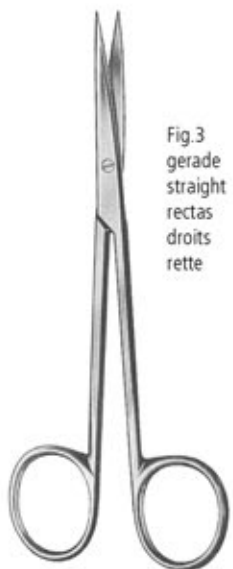

Fig. 3
gerade
straight
rectas
droits
rette

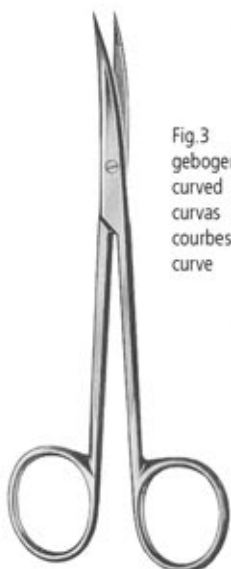
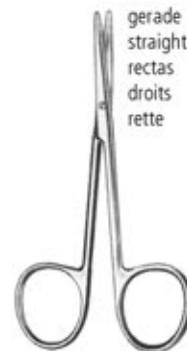

Fig. 3
gebogen
curved
curvas
courbes
curve



1/1



gerade
straight
rectas
droits
rette

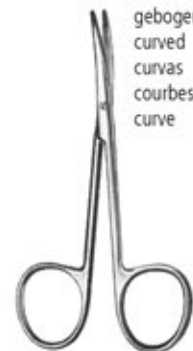

gebogen
curved
curvas
courbes
curve



1/1

METZENBAUM

AC 104/14
14,5 cm/5³/₄"

AC 105/14
14,5 cm/5³/₄"

METZENBAUM-BABY

AC 108/11
11,5 cm/4¹/₂"

AC 109/11

SCHEREN SCISSORS TIJERAS CISEAUX FORBICI

Präparierscheren
Dissecting Scissors
Tijeras para preparaciones
Ciseaux à dissection
Forbici per preparazioni

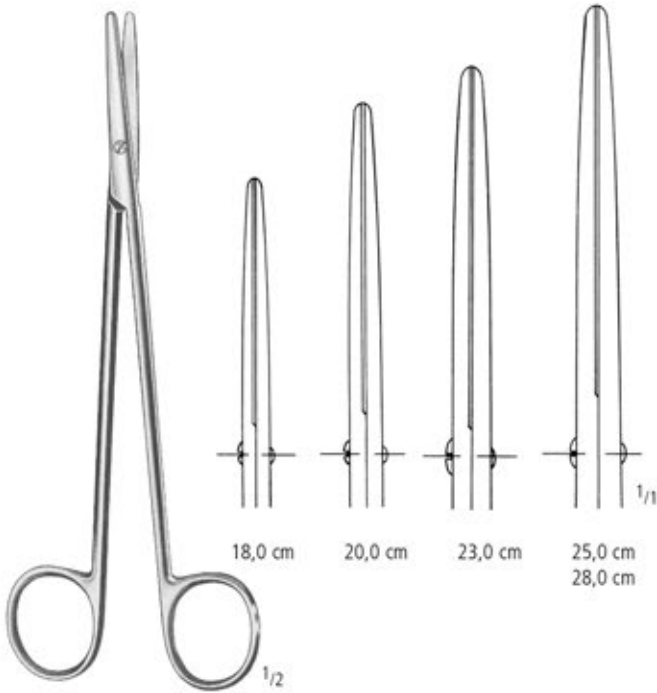

METZENBAUM-NELSON



METZENBAUM-NELSON



Fig. 1



Fig. 2



Fig. 3



18,0 cm/7"	AC 110/18*	AC 111/18*	AC 120/18	AC 121/18	AC 130/18	AC 131/18
20,0 cm/8"	AC 110/20*	AC 111/20*	AC 120/20	AC 121/20	AC 130/20	AC 131/20
23,0 cm/9"	AC 110/23*	AC 111/23*	AC 120/23	AC 121/23	AC 130/23	AC 131/23
25,0 cm/10"	AC 110/25	AC 111/25	AC 120/25	AC 121/25	AC 130/25	AC 131/25
28,0 cm/11"	AC 110/28	AC 111/28	AC 120/28	AC 121/28	AC 130/28	AC 131/28
30,0 cm/12"	AC 110/30	AC 111/30	AC 120/30	AC 121/30	AC 130/30	AC 131/30

Präparierscheren, DELICATE
 Dissecting Scissors, DELICATE
 Tijeras para preparaciones, DELICATE
 Ciseaux à dissection, DELICATE
 Forbici per preparazioni, DELICATE

METZENBAUM-DELICATE

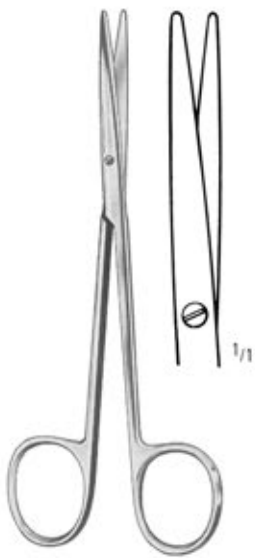

Fig. 1
 AC 140/14
 14,5 cm/5³/₄"



Fig. 1
 AC 141/14*
 14,5 cm/5³/₄"



Fig. 3
 AC 142/14
 14,5 cm/5³/₄"

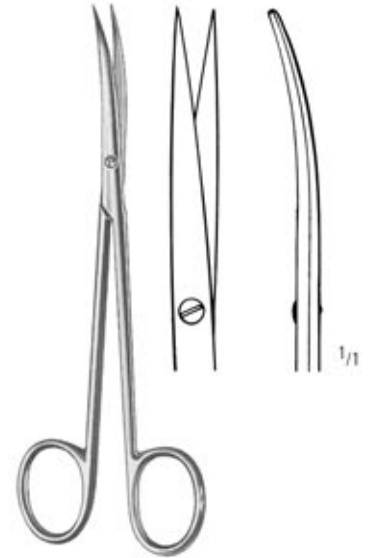

Fig. 3
 AC 143/14
 14,5 cm/5³/₄"

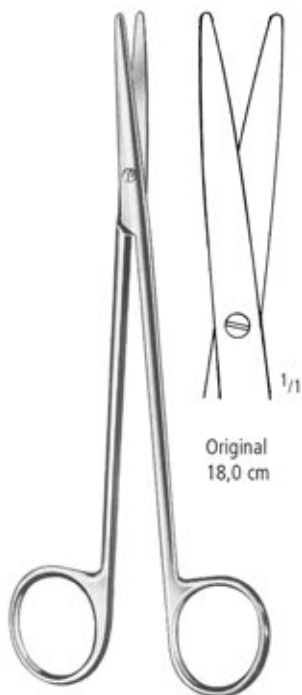

Fig. 1

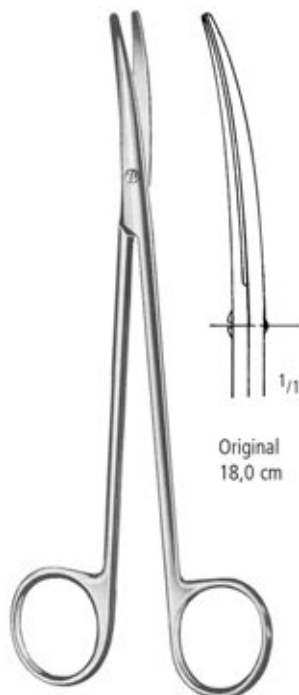

Fig. 1

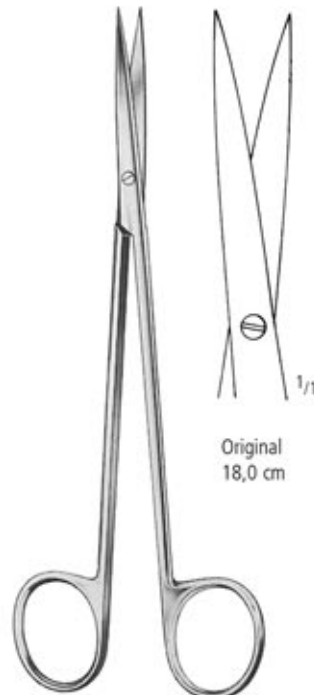

Fig. 3

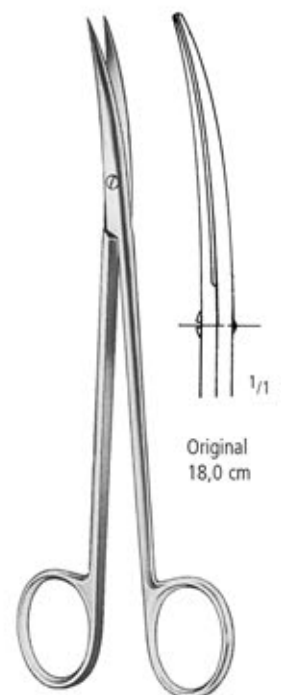

Fig. 3

18,0 cm/7"	AC 150/18	AC 151/18*	AC 152/18	AC 153/18
20,0 cm/8"	AC 150/20	AC 151/20	AC 152/20	AC 153/20
23,0 cm/9"	AC 150/23	AC 151/23	AC 152/23	AC 153/23
25,0 cm/10"			AC 152/25	AC 153/25
28,0 cm/11"			AC 152/28	AC 153/28
30,0 cm/12"			AC 152/30	AC 153/30

SCHEREN SCISSORS TIJERAS CISEAUX FORBICI

Präparierscheren
Dissecting Scissors
Tijeras para preparaciones
Ciseaux à dissection
Forbici per preparazioni

AA
AB
AC
AD
AE
AF
AG
AH
AI
AJ
AK
AL
AM
AN
AO
AP
AQ
AR
AS
AT
AU
AV
AW
AX
AY
AZ

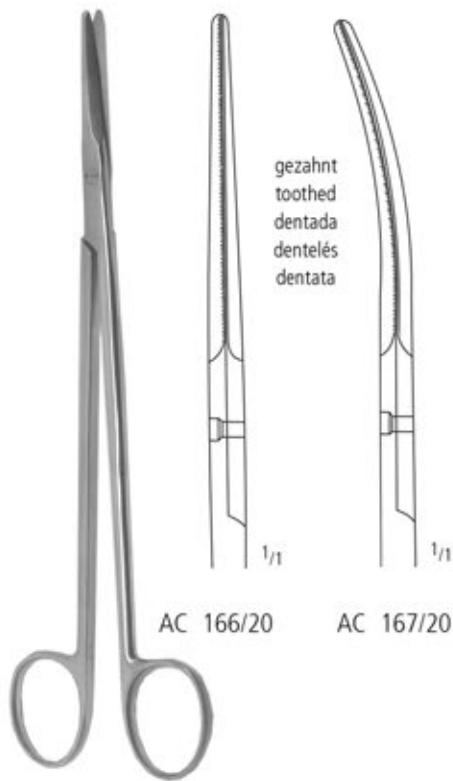

GORNEY
19,5 cm/7³/₄"

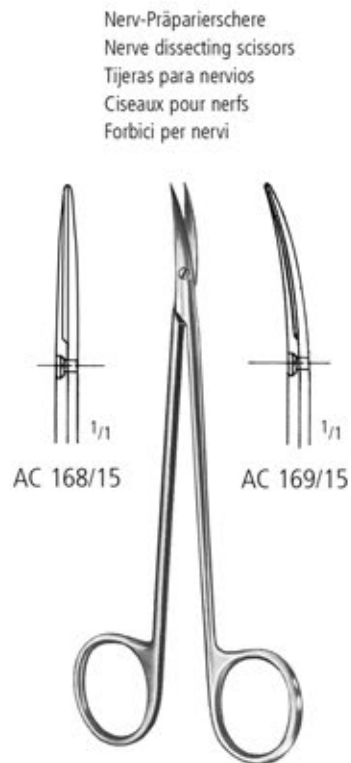

Nerv-Präparierschere
Nerve dissecting scissors
Tijeras para nervios
Ciseaux pour nerfs
Forbici per nervi

15,0 cm/6"



LEXER
AC 170/16
16,0 cm/6¹/₄"



LEXER
AC 171/16
16,0 cm/6¹/₄"



FOMON
AC 173/13
13,5 cm/5¹/₄"

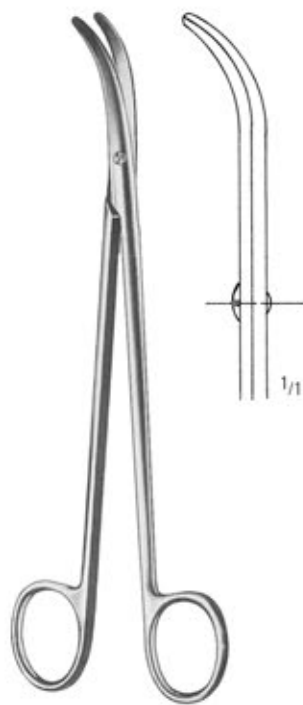

THOREK
AC 175/19
19,0 cm/7¹/₂"



LEXER-BABY
AC 176/10
10,0 cm/4"

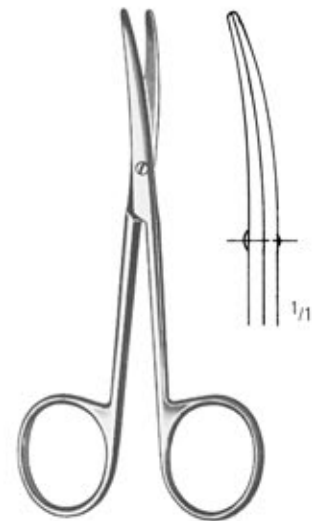

LEXER-BABY
AC 177/10
10,0 cm/4"

AC SCHEREN SCISSORS TIJERAS CISEAUX FORBICI

Präparierscheren
Dissecting Scissors
Tijeras para preparaciones
Ciseaux à dissection
Forbici per preparazioni

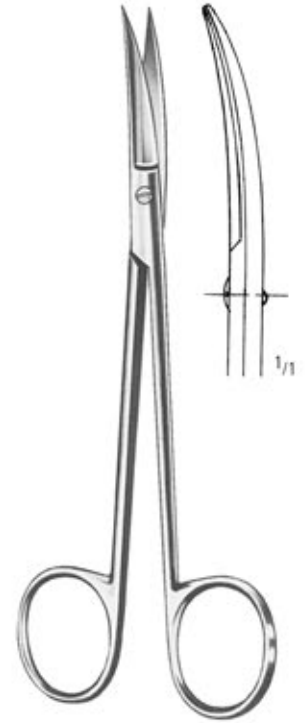
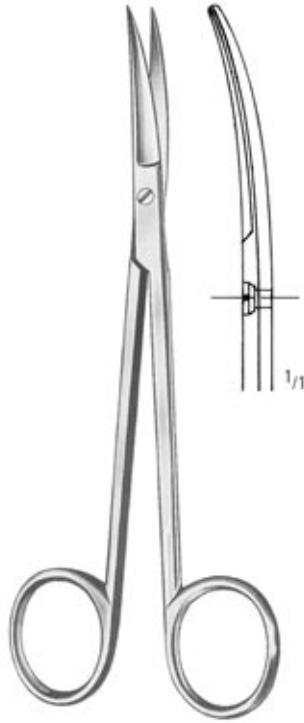

SANVENERO

AC 200/14
14,0 cm/5 1/2"

AC 201/14
14,0 cm/5 1/2"

JOSEPH

AC 204/14
14,0 cm/5 1/2"

AC 205/14
14,0 cm/5 1/2"

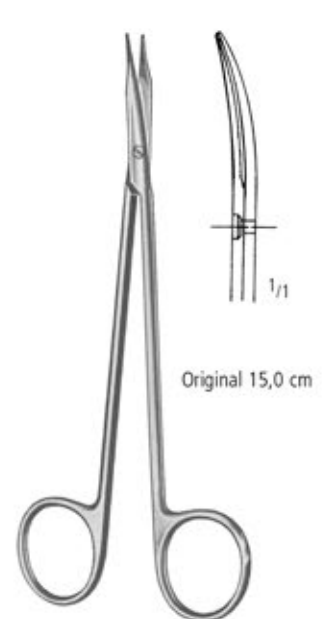
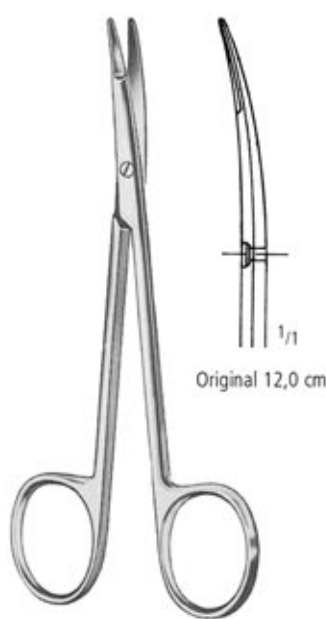

KILNER (RAGNELL)

AC 208/12	12,0 cm/4 3/4"	AC 210/12
AC 208/15	15,0 cm/6"	AC 210/15
AC 208/18	18,0 cm/7"	AC 210/18
AC 208/20	20,0 cm/8"	AC 210/20

REYNOLDS

AC 214/15*	15,0 cm/6"	AC 215/15
AC 214/18*	18,0 cm/7"	AC 215/18

SCHEREN SCISSORS TIJERAS CISEAUX FORBICI

Episiotomie- und Nabelschnurscheren
 Episiotomy and Umbilical Scissors
 Tijeras para episiotomia, Tijeras umbilicales
 Ciseaux à épisiotomie et pour le cordon ombilical
 Forbici per episiotomia, Forbici ombelicale



BRAUN-STADLER
 AC 351/14
 14,0 cm/5½"

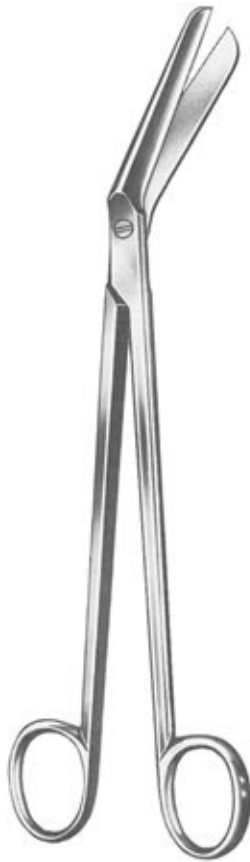

BRAUN-STADLER
 20,0 cm/8" AC 351/20
 22,0 cm/8¾" AC 351/22

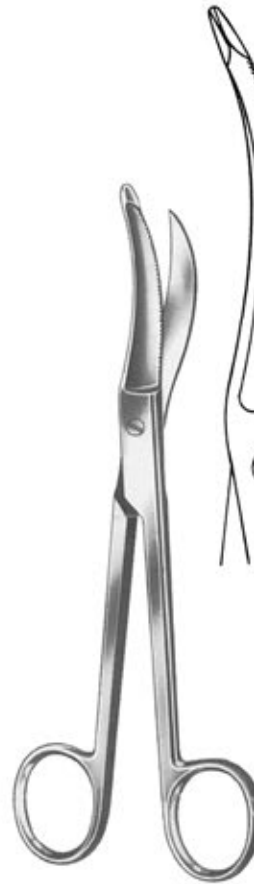

WALDMANN
 AC 353/18
 18,0 cm/7"



AC 354/20
 20,0 cm/8"



MARBACH
 AC 355/15
 15,5 cm/6"



MOD. USA
 AC 360/10
 10,5 cm/4¼"



SCHUMACHER
 AC 362/16
 16,0 cm/6¼"



BUSCH
 13,0 cm/5" AC 365/13
 16,0 cm/6¼" AC 365/16

AA
 AB
AC
 AD
 AE
 AF
 AG
 AH
 AI
 AJ
 AK
 AL
 AM
 AN
 AO
 AP
 AQ
 AR
 AS
 AT
 AU
 AV
 AW
 AX

Feine chirurgische Scheren
 Fine Operating Scissors
 Tijeras finas para cirugía
 Ciseaux fins à chirurgie
 Forbici fini per chirurgia



WAGNER
 12,0 cm/4³/₄"

gerade
 straight
 rectas
 droits
 rette



Fig. 1
 AC 404/01



Fig. 2
 AC 404/02



Fig. 3
 AC 404/03

gebogen
 curved
 curvas
 courbes
 curve



Fig. 1
 AC 405/01



Fig. 2
 AC 405/02



Fig. 3
 AC 405/03



AC 408/11
 11,0 cm/4¹/₃"



AC 409/11
 11,0 cm/4¹/₃"

SCHEREN SCISSORS TIJERAS CISEAUX FORBICI

Feine Scheren
 Fine Scissors
 Tijeras finas
 Ciseaux fins
 Forbici fini

AA
 AB
 AC
 AD
 AE
 AF
 AG
 AH
 AI
 AJ
 AK
 AL
 AM
 AN
 AO
 AP
 AQ
 AR
 AS
 AT
 AU
 AV
 AW
 AX

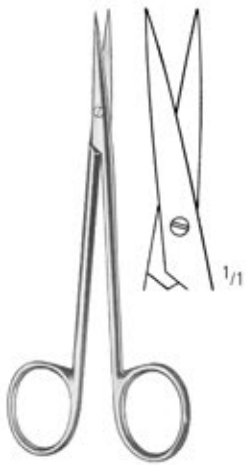

AC 410/11
 11,5 cm/4 1/2"

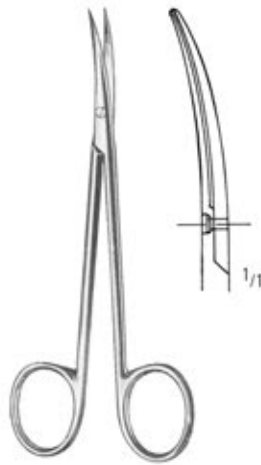

AC 411/11
 11,5 cm/4 1/2"

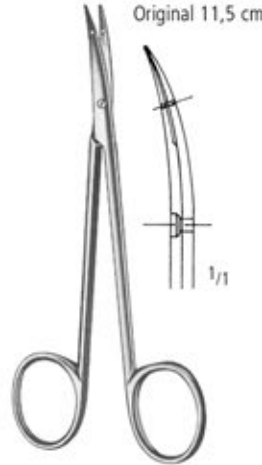

LITTLER
 AC 412/11 11,5 cm/4 1/2"
 AC 412/14 14,0 cm/5 1/2"

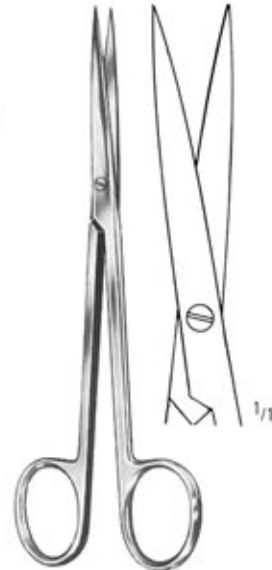

BROPHY (SULLIVAN)
 AC 414/14
 14,5 cm/5 3/4"

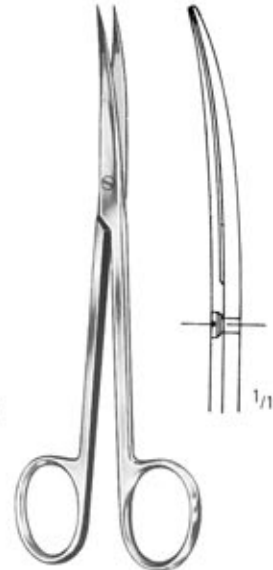

AC 415/14
 14,5 cm/5 3/4"

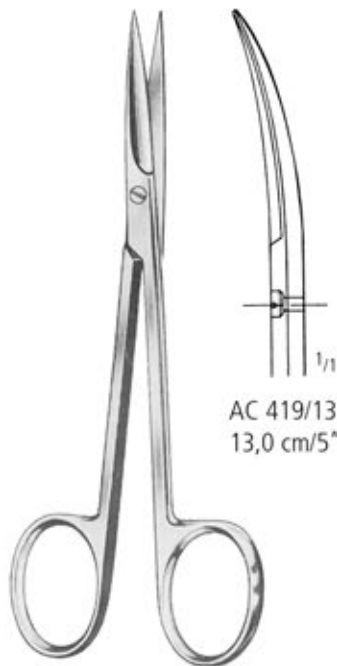

AC 418/13
 13,0 cm/5"

AC 419/13
 13,0 cm/5"



AC 422/10
 AC 422/11

10,5 cm/4 1/4"
 11,5 cm/4 1/2"



AC 423/10
 AC 423/11



AC 424/11
 11,5 cm/4 1/2"

Feine Scheren
 Fine Scissors
 Tijeras finas
 Ciseaux fins
 Forbici fini

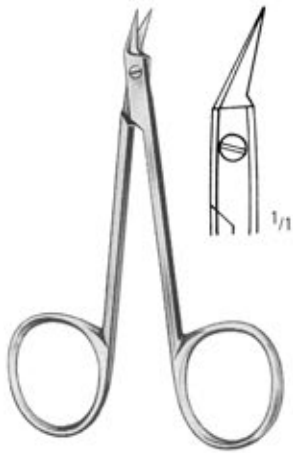

O'BRIEN
 AC 427/09
 9,0 cm/3 1/2"

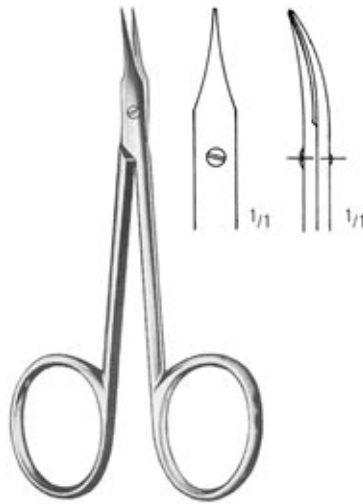

WALTON
 AC 429/10
 10,0 cm/4"

sehr fein
 extra delicate
 muy finas
 très fin
 molto sottile



AC 430/08
 8,0 cm/3"

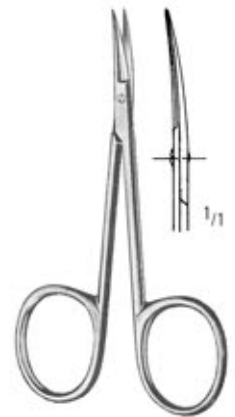

MOD. BONN
 AC 431/08
 8,0 cm/3"

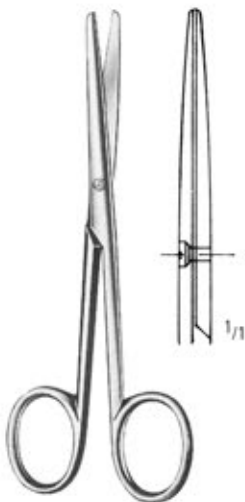

LANDOLT
 AC 434/12
 12,5 cm/5"

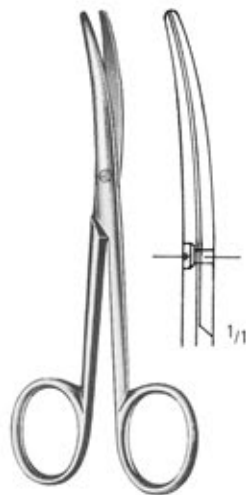

LANDOLT
 AC 435/12
 12,5 cm/5"

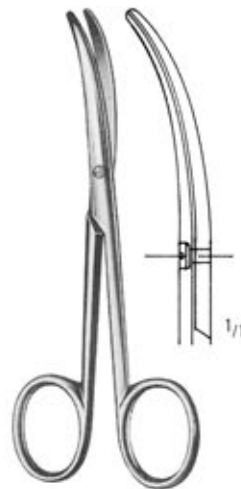

LANDOLT
 AC 436/12
 12,5 cm/5"

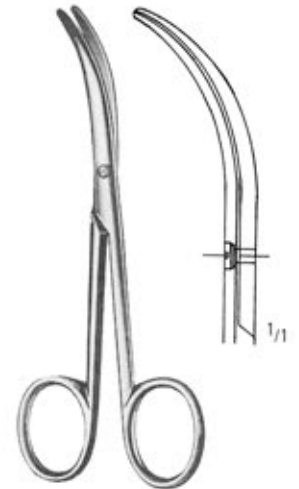

LANDOLT
 AC 437/12
 12,5 cm/5"

SCHEREN SCISSORS TIJERAS CISEAUX FORBICI

Ligaturscheren
Ligature Scissors
Tijeras para ligaduras
Ciseaux à ligatures
Forbici per legatura



SPENCER

9,0 cm/3¹/₂" AC 500/09
10,5 cm/4¹/₄" AC 500/10
12,5 cm/5" AC 500/13



SPENCER-DELICATE

AC 501/11
11,0 cm/4¹/₃"



LITTAUER

AC 502/14
14,0 cm/5¹/₂"



AC 503/16
16,0 cm/6¹/₄"



EISELSBERG

AC 504/12
11,0 cm/4¹/₃"



SCHOEMAKER-LOTH

AC 505/12
12,5 cm/5"



AC 506/11
11,5 cm/4¹/₂"

AA
AB
AC
AD
AE
AF
AK
AL
AO
AP
AR
KB
KI
KC
KU
KYE
X

Ligaturscheren
Ligature Scissors
Tijeras para ligaduras
Ciseaux à ligatures
Forbici per legatura

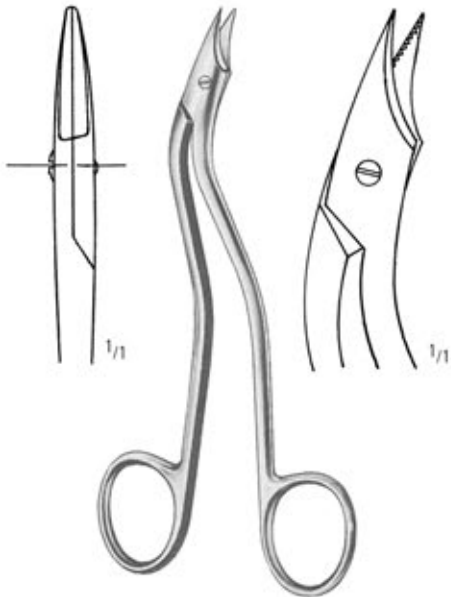

HEATH
AC 507/15
15,0 cm/6"



gezahnt
saw edge
dentadas
dentelés
dentata

AC 509/12
12,0 cm/4³/₄"



SHORTBENT
AC 513/09
9,0 cm/3¹/₂"



NORTHBENT
AC 514/12
12,5 cm/5"



BUCK
14,5 cm/5³/₄" AC 516/14
18,0 cm/7" AC 516/18

SCHEREN SCISSORS TIJERAS CISEAUX FORBICI

Mikroscheren
Micro Scissors
Micro Tijeras
Micro Ciseaux
Micro Forbici

- >> Alle unsere Mikroscheren werden von Fachkräften mit jahrelanger Erfahrung hergestellt. Die Endkontrolle findet unter dem Mikroskop statt. Um Ihnen ein ermüdungsfreies Arbeiten zu ermöglichen, wird dem Federdruck größte Aufmerksamkeit gewidmet.
- >> Bitte wählen Sie unter Rund- oder Flachgriffscheren.

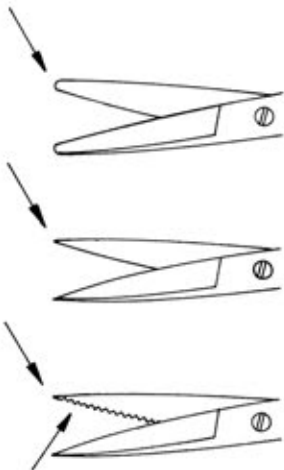

Dissection: **Gebogene Blätter, abgerundete Spitzen** ermöglichen eine gute und sichere Dissektion, ohne Nerven und Blutgefäße zu beschädigen.

Adventitia: **Gerade Blätter, sehr scharfe Spitzen** gewährleisten präzises Anfrischen von Gefäßenden.

Nerve: Ein Blatt ist **fein gezahnt**, um ein Herausgleiten des Nervs zu vermeiden.

- >> All our Micro Scissors are manufactured by skilled craftsmen with many years of experience. Final inspection is carried out under a microscope. Careful attention is paid to the closing pressure of the spring handle, to ensure precise work during surgeries, without fatigue.
- >> Round or flat handle scissors according to your preference.

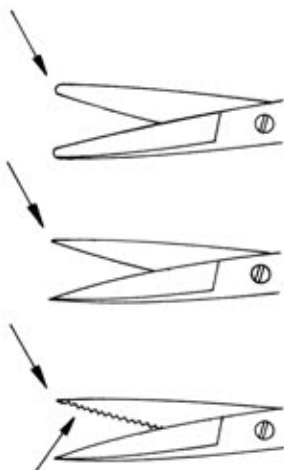

Dissection: **Curved blades, slightly rounded tips** ensure safe dissection without damage to nerves and vessels.

Adventitia: **Straight blades, very sharp tips** for finest trimming of vessel ends.

Nerve: One blade is **fine-toothed** to avoid slipping of the nerve.

AA

AB

AC

AD

AE

AF

AK

AL

AO

AP

AR

KB

KI

KC

KU

KYE

X

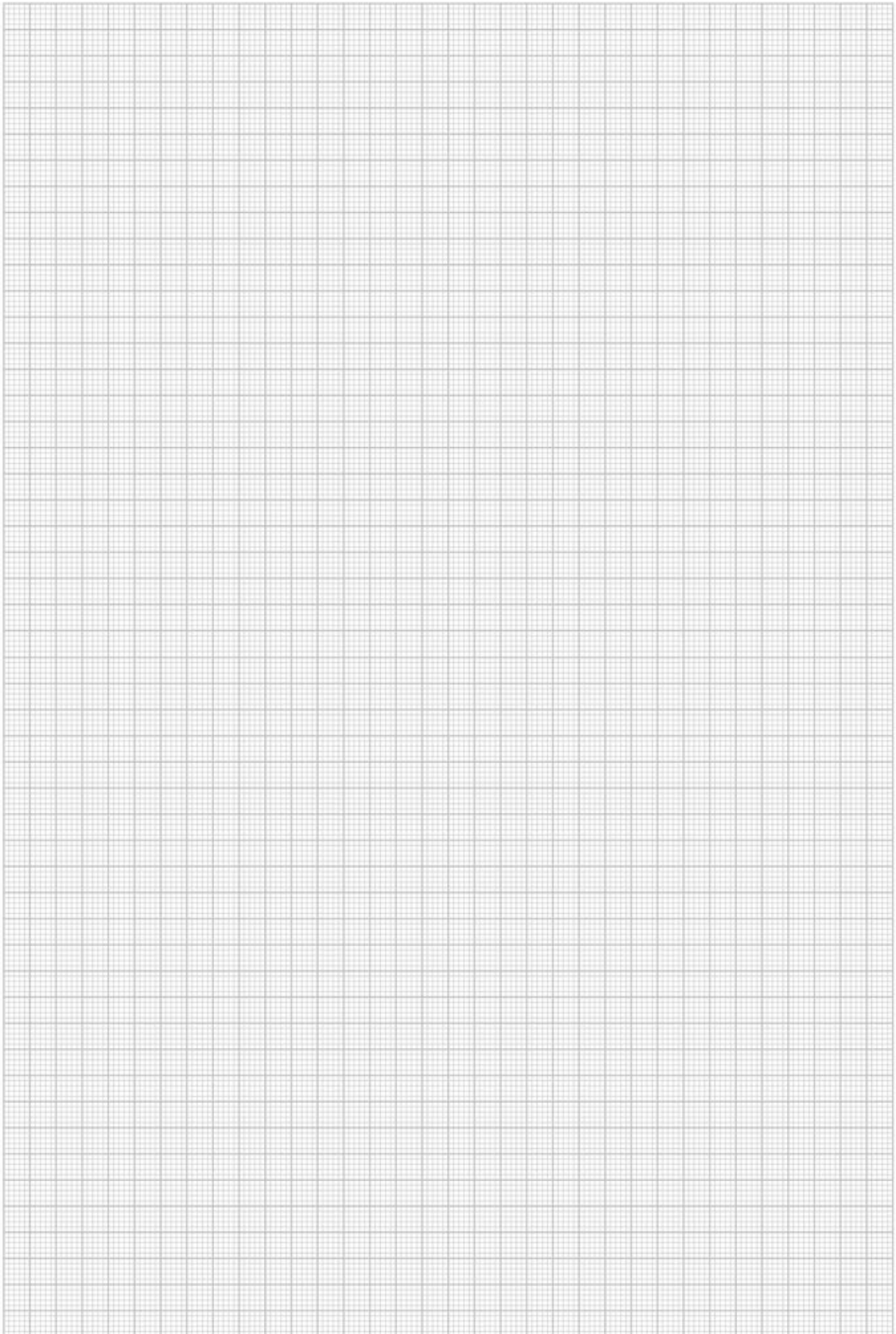

SCHEREN SCISSORS TIJERAS CISEAUX FORBICI

Mikroscheren
Micro Scissors
Micro Tijeras
Micro Ciseaux
Micro Forbici

AA

AB

AC

AD

AE

AF

AK

AL

AO

AP

AR

KB

KI

KC

KU

KYE

X



14,5 cm/5³/₄"



Dissection
AC 801/15

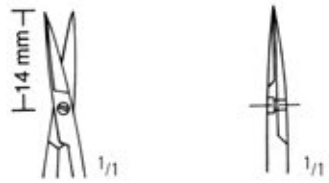

Adventitia
AC 803/15



18,0 cm/7"



Dissection
AC 801/18



Adventitia
AC 803/18

AC SCHEREN SCISSORS TIJERAS CISEAUX FORBICI

Mikroscheren
 Micro Scissors
 Micro Tijeras
 Micro Ciseaux
 Micro Forbici

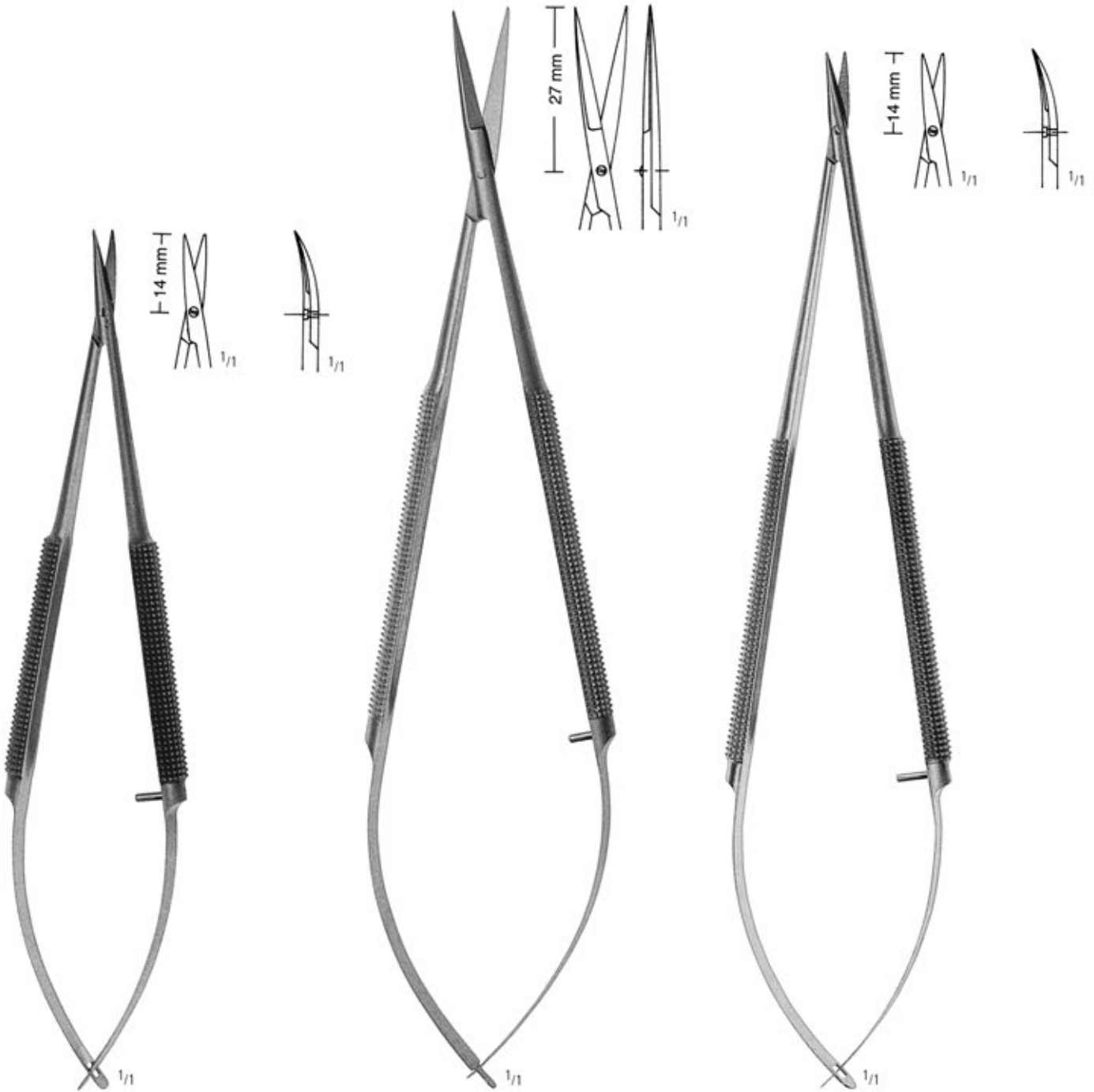

AC 807/14
 14,5 cm/5³/₄"

AC 812/18
 18,0 cm/7"

AC 817/18
 18,0 cm/7"

SCHEREN SCISSORS TIJERAS CISEAUX FORBICI

Mikroschere
Micro Scissors
Micro Tijeras
Micro Ciseaux
Micro Forbici

AA

AB

AC

AD

AE

AF

AK

AL

AO

AP

AR

KB

KI

KC

KU

KYE

X



11,0 cm/4 1/3"

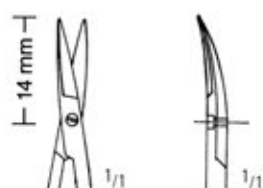

Dissection
AC 821/11

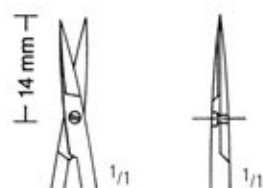

Adventitia
AC 830/11



15,0 cm/6"

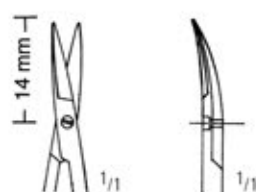

Dissection
AC 823/15

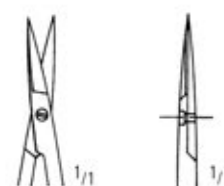

Adventitia
AC 832/15

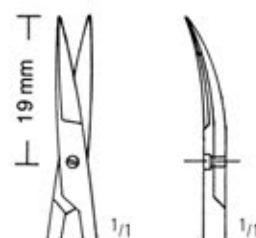

Dissection
AC 825/15

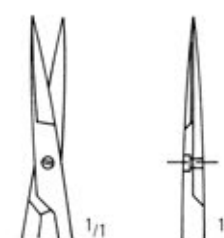

Adventitia
AC 834/15

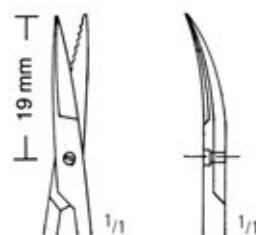

Dissection
AC 827/15

>> Nerve >>

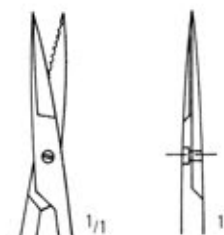

Adventitia
AC 836/15

AC SCHEREN SCISSORS TIJERAS CISEAUX FORBICI

Mikroscheren
Micro Scissors
Micro Tijeras
Micro Ciseaux
Micro Forbici



18,5 cm/7¹/₃"



AC 850/19



AC 851/19



16,0 cm/6¹/₄"
20,0 cm/8"
22,5 cm/9"



AC 860/16
AC 860/20
AC 860/22



AC 861/16
AC 861/20
AC 861/22



AC 862/16
AC 862/20
AC 862/22



AC 863/16
AC 863/20
AC 863/22



AC 864/16
AC 864/20
AC 864/22



AC 865/16
AC 865/20
AC 865/22

SCHEREN SCISSORS TIJERAS CISEAUX FORBICI

Mikroscheren
Micro Scissors
Micro Tijeras
Micro Ciseaux
Micro Forbici



18,0 cm/7"



AC 870/01
25°



AC 870/02
45°



AC 870/03
60°



AC 870/04
90°



AC 870/05
125°



18,0 cm/7"



AC 871/01
25°



AC 871/02
45°



AC 871/03
60°



AC 871/04
90°



AC 871/05
125°

AA
AB
AC
AD
AE
AF
AK
AL
AO
AP
AR
KB
KI
KC
KU
KYE
X



nopa® TUC®

SC Super Cut

SUPER CUT TUC



Besonderheit:

Nutzen Sie die Vorteile von Hartmetalleinsätzen.

nopa TUC Super Cut Scheren haben eine rasierklingscharfe Schneide, kombiniert mit einer mikrogezahnten Schneide.

>> Diese Scheren sind durch schwarz/goldene Ringe gekennzeichnet.

Features:

Use the advantages of Tungsten Carbide.

nopa TUC Super Cut scissors have a razor-like edge combined with one micro serrated blade.

>> Black/golden rings for easy identification.

Verfügbare Modelle / Available Patterns

Im Katalog durch * markiert. / Marked in catalog with *.

AC 902/14 SC STANDARD SCS TUC STR. SH/BL 14,5 CM SC
AC 903/14 SC STANDARD SCS TUC CVD. SH/BL 14,5 CM SC
AC 910/14 SC MAYO DISS. SCS TUC STR. BL/BL 14,5 CM SC
AC 910/17 SC MAYO DISS. SCS TUC STR. BL/BL 17,0 CM SC
AC 911/14 SC MAYO DISS. SCS TUC CVD. BL/BL 14,5 CM SC
AC 911/17 SC MAYO DISS. SCS TUC CVD. BL/BL 17,0 CM SC
AC 916/15 SC MAYO-STILLE SCS TUC STR. BL/BL 15,0 CM SC
AC 916/17 SC MAYO-STILLE SCS TUC STR. BL/BL 17,0 CM SC
AC 917/15 SC MAYO-STILLE SCS TUC CVD. BL/BL 15,0 CM SC
AC 917/17 SC MAYO-STILLE SCS TUC CVD. BL/BL 17,0 CM SC
AC 930/14 SC METZENBAUM SCS TUC STR. BL/BL 14,5 CM SC
AC 931/14 SC METZENBAUM SCS TUC CVD. BL/BL 14,5 CM SC
AC 940/18 SC METZENBAUM SCS TUC STR. BL/BL 18,0 CM SC
AC 940/20 SC METZENBAUM SCS TUC STR. BL/BL 20,0 CM SC
AC 941/18 SC METZENBAUM SCS TUC CVD. BL/BL 18,0 CM SC
AC 941/20 SC METZENBAUM SCS TUC CVD. BL/BL 20,0 CM SC
AC 941/23 SC METZENBAUM SCS TUC CVD. BL/BL 23,0 CM SC
AC 941/25 SC METZENBAUM SCS TUC CVD. BL/BL 25,0 CM SC
AC 941/28 SC METZENBAUM SCS TUC CVD. BL/BL 28,0 CM SC
AC 960/14 SC METZENBAUM-DEL. SCS TUC STR. BL/BL 14,5 CM SC
AC 961/14 SC METZENBAUM-DEL. SCS TUC CVD. BL/BL 14,5 CM SC
AC 970/18 SC METZENBAUM-DEL. SCS TUC STR. BL/BL 18,0 CM SC
AC 970/20 SC METZENBAUM-DEL. SCS TUC STR. BL/BL 20,0 CM SC
AC 971/18 SC METZENBAUM-DEL. SCS TUC CVD. BL/BL 18,0 CM SC
AC 971/20 SC METZENBAUM-DEL. SCS TUC CVD. BL/BL 20,0 CM SC
AC 974/11 SC STEVENS TENOTOMY SCS STR. POINTED 11,5 CM SC
AC 975/11 SC STEVENS TENOTOMY SCS CVD. POINTED 11,5 CM SC
AC 984/11 SC IRIS SCS TUC STR. SH/SH 11,5 CM SC
AC 985/11 SC IRIS SCS TUC CVD. SH/SH 11,5 CM SC

AC SCHEREN SCISSORS TIJERAS CISEAUX FORBICI

Scheren mit Hartmetalleinlagen
 Scissors with Tungsten Carbide Inserts
 Tijeras con filos de carburo de tungsteno
 Ciseaux avec plaquettes en carbure de tungstène
 Forbici con taglio al carburo di tungsteno

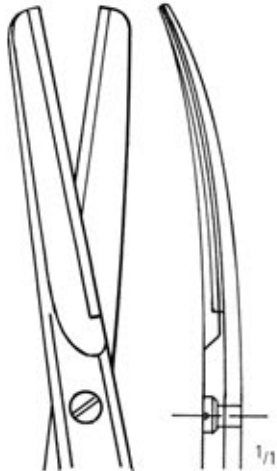

STANDARD
 Fig. 1

straight: 14,5 cm/5³/₄"
 AC 900/14
 curved: AC 901/14

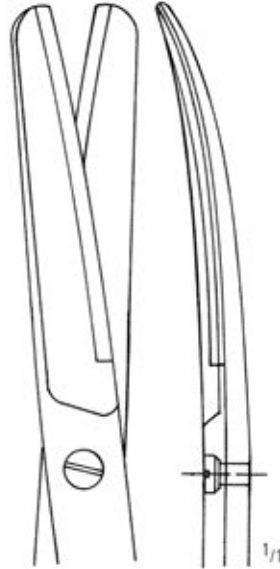

16,5 cm/6¹/₂"
 AC 900/16
 AC 901/16

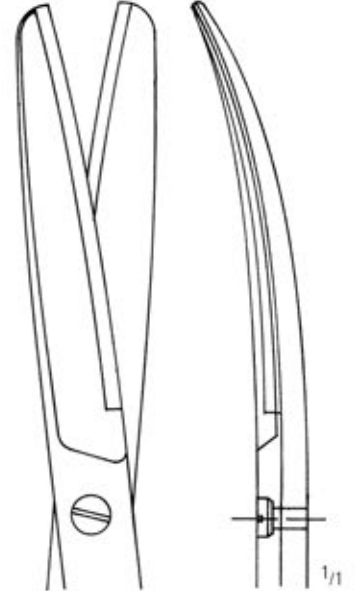

18,5 cm/7¹/₃"
 AC 900/18
 AC 901/18

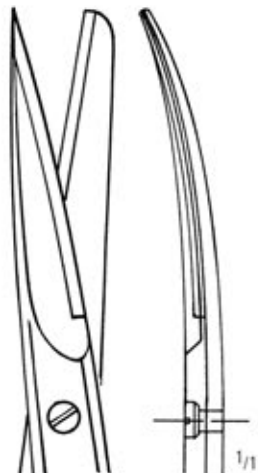

STANDARD
 Fig. 2

straight: 14,5 cm/5³/₄"
 AC 902/14*
 curved: AC 903/14*

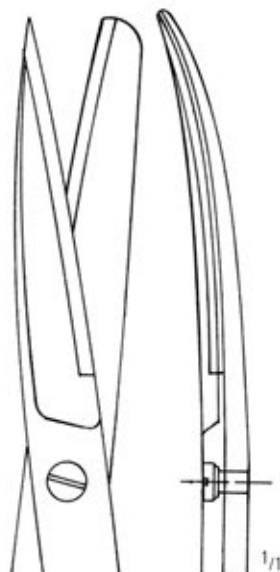

16,5 cm/6¹/₂"
 AC 902/16
 AC 903/16

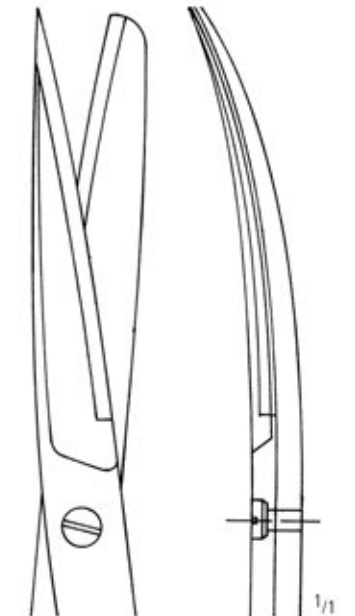

18,5 cm/7¹/₃"
 AC 902/18
 AC 903/18

SCHEREN SCISSORS TIJERAS CISEAUX FORBICI

Scheren mit Hartmetalleinlagen
 Scissors with Tungsten Carbide Inserts
 Tijeras con filos de carburo de tungsteno
 Ciseaux avec plaquettes en carbure de tungstène
 Forbici con taglio al carburo di tungsteno

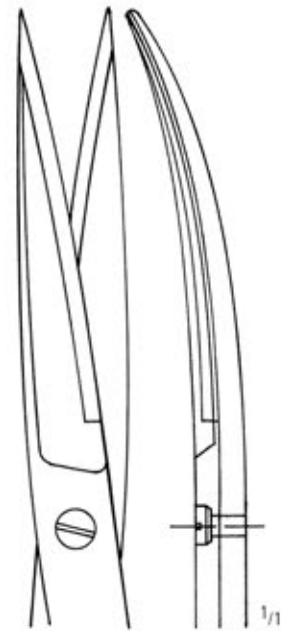
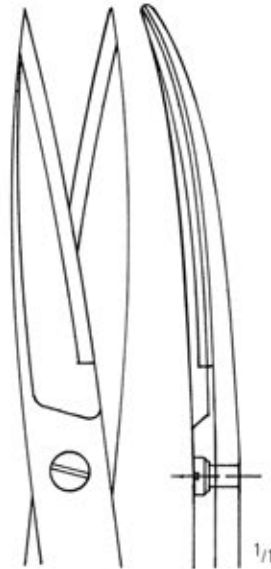
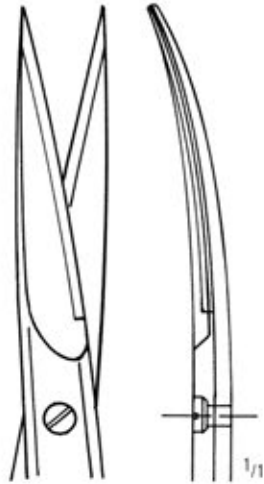

STANDARD
 Fig. 3

straight: 14,5 cm/5³/₄"
 AC 904/14
 curved: AC 905/14

16,5 cm/6¹/₂"
 AC 904/16
 AC 905/16

18,5 cm/7¹/₃"
 AC 904/18
 AC 905/18

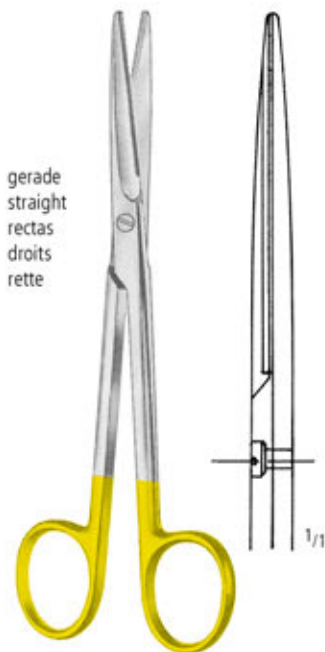

gerade
 straight
 rectas
 droits
 rette

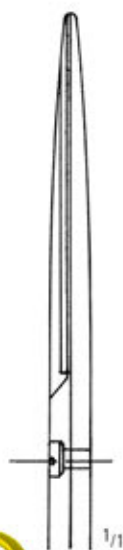

Original 17,0 cm



gebogen
 curved
 curvas
 courbes
 curve

MAYO
 AC 910/14*
 AC 910/17*
 AC 910/23

14,5 cm/5¹/₂"
 17,0 cm/6³/₄"
 23,0 cm/9"

MAYO
 AC 911/14*
 AC 911/17*
 AC 911/23

* Auch erhältlich als SC * Also available as SC

AA
 AB
AC
 AD
 AE
 AF
 AG
 AH
 AI
 AJ
 AK
 AL
 AM
 AN
 AO
 AP
 AQ
 AR
 AS
 AT
 AU
 AV
 AW
 AX

AC SCHEREN SCISSORS TIJERAS CISEAUX FORBICI

Scheren mit Hartmetalleinlagen
 Scissors with Tungsten Carbide Inserts
 Tijeras con filos de carburo de tungsteno
 Ciseaux avec plaquettes en carbure de tungstène
 Forbici con taglio al carburo di tungsteno



PARAMETRIUM



1/1



1/1

AC 915/01
22,5 cm/9"

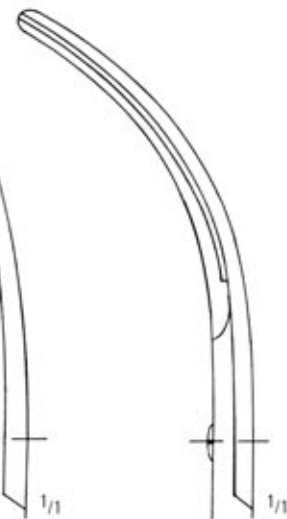

1/1

AC 915/02
23,0 cm/9"



1/2

MAYO-STILLE
 AC 916/15*
 AC 916/17*



1/1



1/1

Original 17,0 cm

15,0 cm/6"
 17,0 cm/6³/₄"



1/1



1/2

MAYO-STILLE
 AC 917/15*
 AC 917/17*

SCHEREN SCISSORS TIJERAS CISEAUX FORBICI

Scheren mit Hartmetalleinlagen
 Scissors with Tungsten Carbide Inserts
 Tijeras con filos de carburo de tungsteno
 Ciseaux avec plaquettes en carbure de tungstène
 Forbici con taglio al carburo di tungsteno

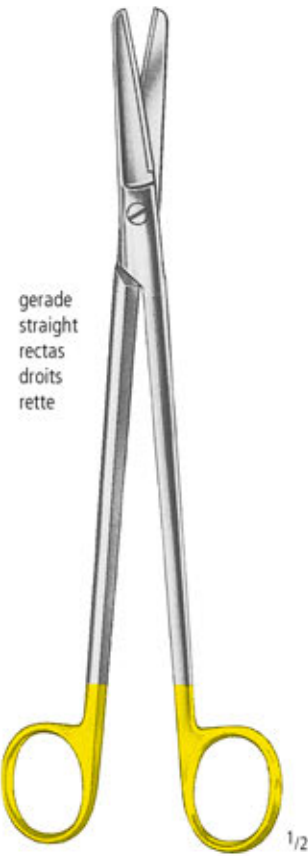

gerade
straight
rectas
droits
rette

SIMS
 AC 918/23
 23,0 cm/9"

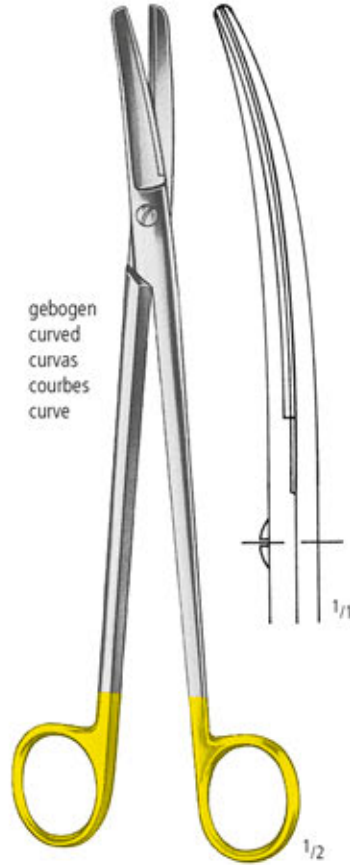

gebogen
curved
curvas
courbes
curve

SIMS
 AC 919/23
 23,0 cm/9"



AC 920/20
 20,0 cm/8"

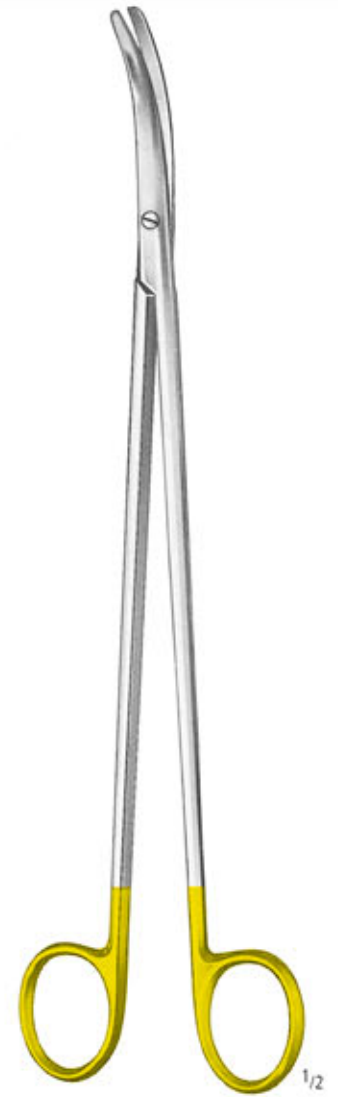

CARDINALE
 AC 921/28
 28,0 cm/11"

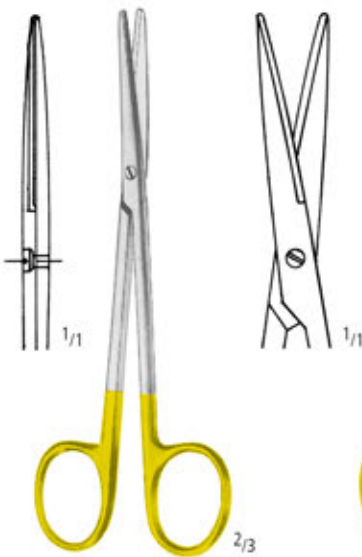

AC 922/11
 11,5 cm/4 1/2"

METZENBAUM

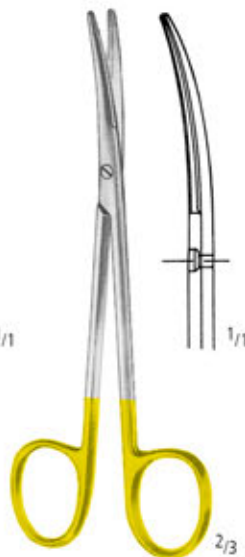

AC 923/11
 11,5 cm/4 1/2"



AC 930/14*
 14,5 cm/5 3/4"

METZENBAUM

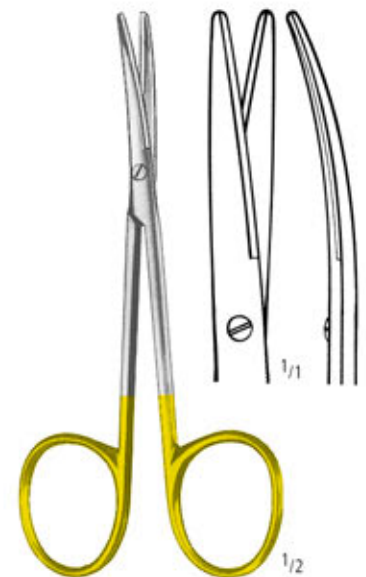

AC 931/14*
 14,5 cm/5 3/4"

* Auch erhältlich als SC * Also available as SC

AA
 AB
 AC
 AD
 AE
 AF
 AG
 AH
 AI
 AJ
 AK
 AL
 AM
 AN
 AO
 AP
 AQ
 AR
 AS
 AT
 AU
 AV
 AW
 AX

AC SCHEREN SCISSORS TIJERAS CISEAUX FORBICI

Scheren mit Hartmetalleinlagen
 Scissors with Tungsten Carbide Inserts
 Tijeras con filos de carburo de tungsteno
 Ciseaux avec plaquettes en carbure de tungstène
 Forbici con taglio al carburo di tungsteno

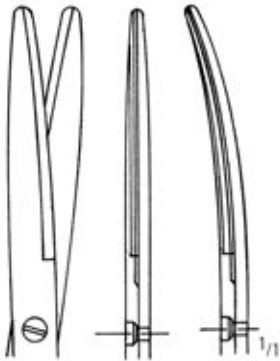

Original 18,0 cm

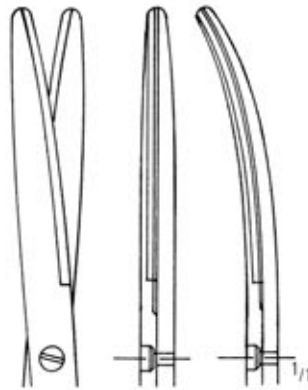

Original 20,0 cm

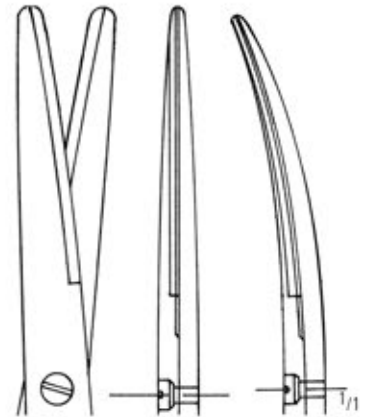

Original 23,0 cm



nopa
TUC®

gerade
 straight
 rectas
 droits
 rette

gebogen
 curved
 curvas
 courbes
 curve

AC 940/18*	18,0 cm/7"	AC 941/18*
AC 940/20*	20,0 cm/8"	AC 941/20*
AC 940/23	23,0 cm/9"	AC 941/23*
AC 940/25	25,0 cm/10"	AC 941/25*
AC 940/28	28,0 cm/11"	AC 941/28*
AC 940/30	30,0 cm/12"	AC 941/30

METZENBAUM

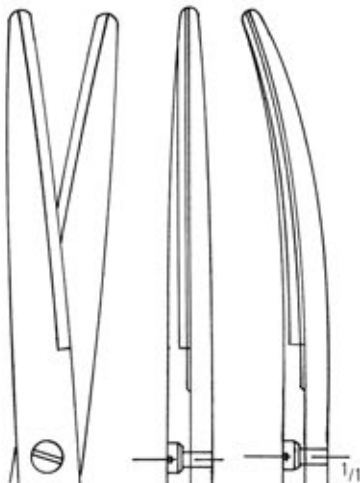

Original 25,0 cm

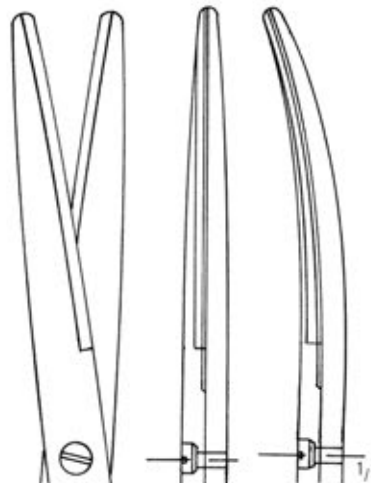

Original 28,0 cm

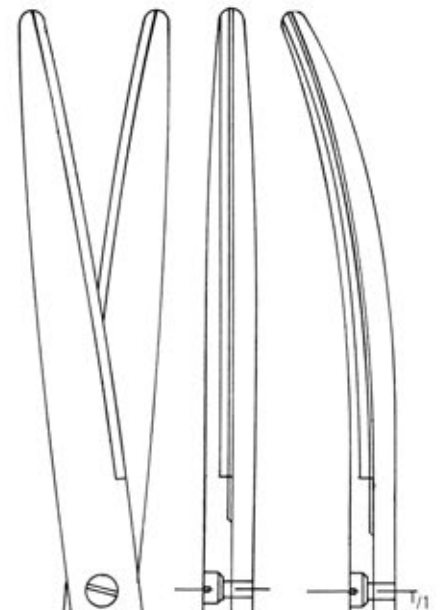

Original 30,0 cm

SCHEREN SCISSORS TIJERAS CISEAUX FORBICI

Scheren mit Hartmetalleinlagen
 Scissors with Tungsten Carbide Inserts
 Tijeras con filos de carburo de tungsteno
 Ciseaux avec plaquettes en carbure de tungstène
 Forbici con taglio al carburo di tungsteno



LEXER
 AC 952/16
 16,0 cm/6¹/₄"



LEXER
 AC 953/16
 16,0 cm/6¹/₄"



AC 960/14*
 14,5 cm/5³/₄"

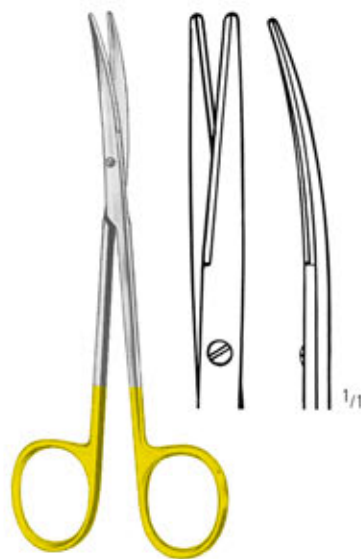

AC 961/14*
 14,5 cm/5³/₄"



METZENBAUM-DELICATE
 AC 962/14
 14,5 cm/5³/₄"

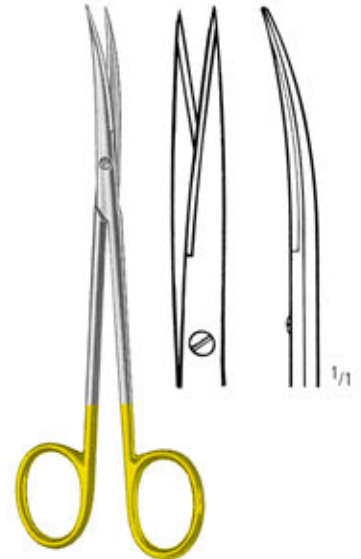

AC 963/14
 14,5 cm/5³/₄"

AA
 AB
AC
 AD
 AE
 AF
 AG
 AH
 AI
 AJ
 AK
 AL
 AM
 AN
 AO
 AP
 AQ
 AR
 AS
 AT
 AU
 AV
 AW
 AX
 AY
 AZ

AC SCHEREN SCISSORS TIJERAS CISEAUX FORBICI

Scheren mit Hartmetalleinlagen
 Scissors with Tungsten Carbide Inserts
 Tijeras con filos de carburo de tungsteno
 Ciseaux avec plaquettes en carbure de tungstène
 Forbici con taglio al carburo di tungsteno

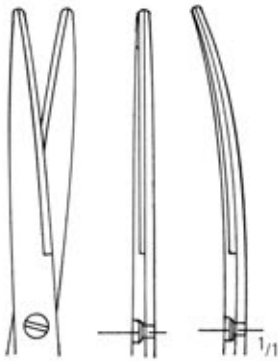

Original 18,0 cm

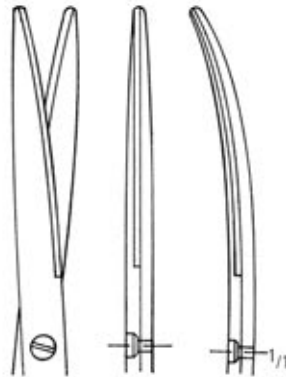

Original 20,0 cm

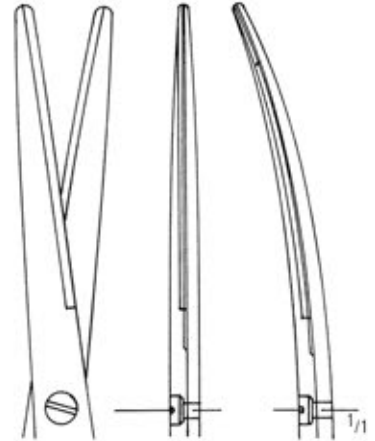

Original 23,0 cm



METZENBAUM-DELICATE



gerade
 straight
 rectas
 droits
 rette

gebogen
 curved
 curvas
 courbes
 curve

AC 970/18*	18,0 cm/7"	AC 971/18*
AC 970/20*	20,0 cm/8"	AC 971/20*
AC 970/23	23,0 cm/9"	AC 971/23
AC 970/25	25,0 cm/10"	AC 971/25
AC 970/28	28,0 cm/11"	AC 971/28

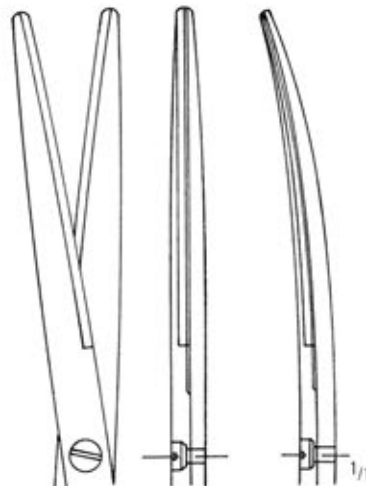

Original 25,0 cm

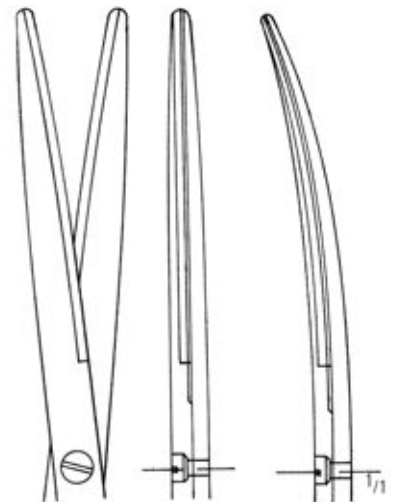

Original 28,0 cm

SCHEREN SCISSORS TIJERAS CISEAUX FORBICI

Scheren mit Hartmetalleinlagen
 Scissors with Tungsten Carbide Inserts
 Tijeras con filos de carburo de tungsteno
 Ciseaux avec plaquettes en carbure de tungstène
 Forbici con taglio al carburo di tungsteno

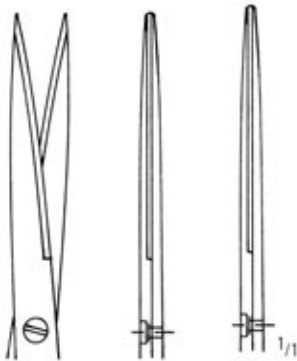

Original 18,0 cm

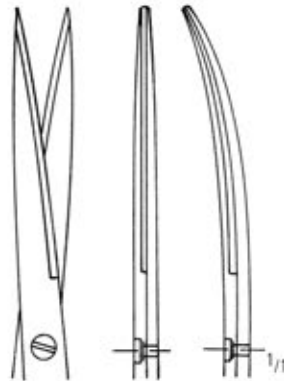

Original 20,0 cm

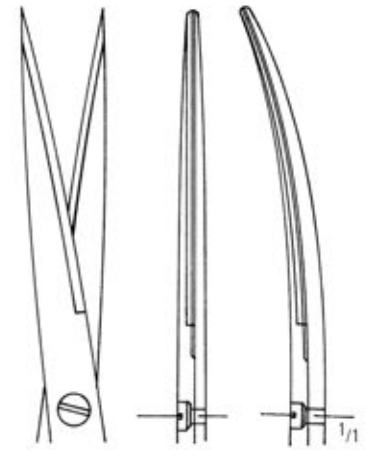

Original 23,0 cm



gerade
 straight
 rectas
 droits
 rette

gebogen
 curved
 curvas
 courbes
 curve

AC 972/18	18,0 cm/7"	AC 973/18
AC 972/20	20,0 cm/8"	AC 973/20
AC 972/23	23,0 cm/9"	AC 973/23
AC 972/25	25,0 cm/10"	AC 973/25
AC 972/28	28,0 cm/11"	AC 973/28

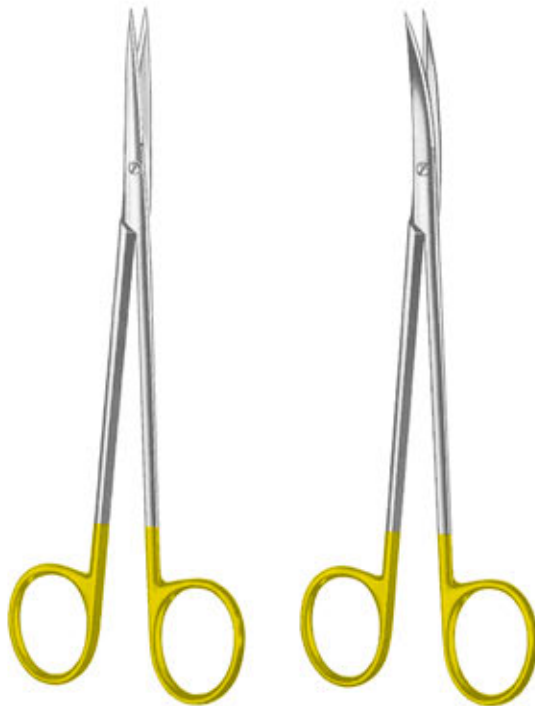

METZENBAUM-DELICATE

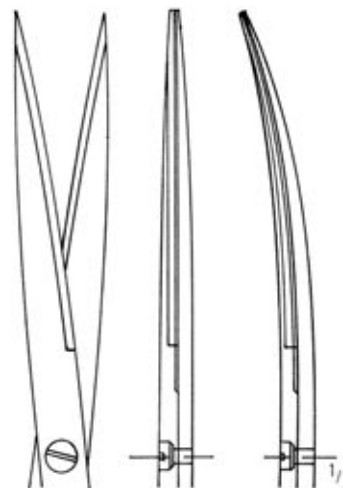

Original 25,0 cm

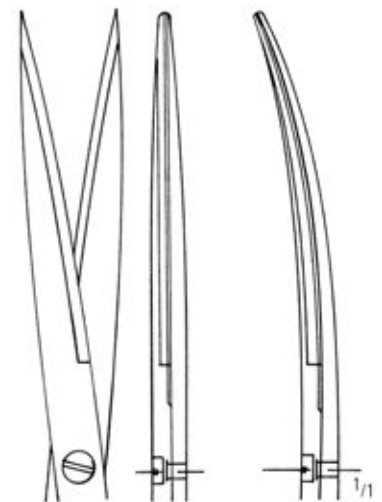

Original 28,0 cm

AA
 AB
AC
 AD
 AE
 AF
 AG
 AH
 AI
 AJ
 AK
 AL
 AM
 AN
 AO
 AP
 AQ
 AR
 AS
 AT
 AU
 AV
 AW
 AX

AC SCHEREN SCISSORS TIJERAS CISEAUX FORBICI

Scheren mit Hartmetalleinlagen
 Scissors with Tungsten Carbide Inserts
 Tijeras con fillos de carburo de tungsteno
 Ciseaux avec plaquettes en carbure de tungstène
 Forbici con taglio al carburo di tungsteno



Original 11,5 cm

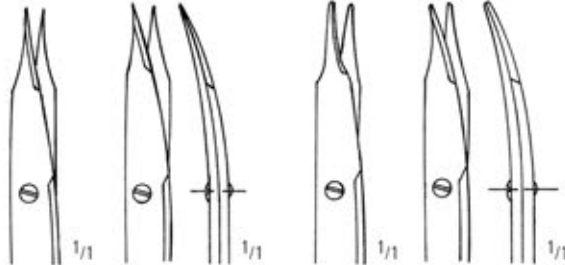

	spitz pointed agudas pointues acuta		stumpf blunt romas mousses smussa
gerade straight rectas droits rette	gebogen curved curvas courbes curve	gerade straight rectas droits rette	gebogen curved curvas courbes curve

STEVENS

10,5 cm/4 ¹ / ₄ "	AC 974/10	AC 975/10	AC 976/10	AC 977/10
11,5 cm/4 ¹ / ₂ "	AC 974/11*	AC 975/11*	AC 976/11	AC 977/11

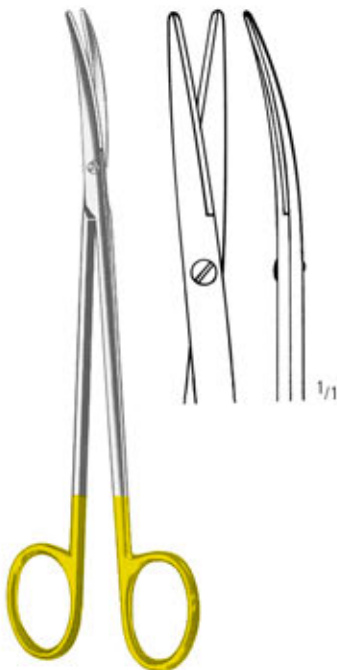

TOENNIS-ADSON-DELICATE

AC 977/17
 17,5 cm/7"



GOLDMAN-FOX

AC 980/13
 13,0 cm/5"



AC 981/13
 13,0 cm/5"

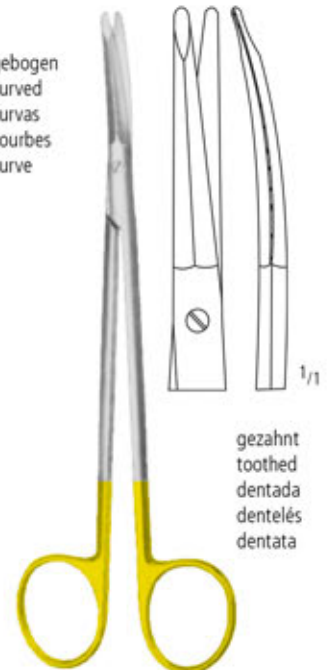

KAYE

AC 983/15
 15,0 cm/6"

gebogen
curved
curvas
courbes
curve

gezahnt
toothed
dentada
dentelés
dentata

SCHEREN SCISSORS TIJERAS CISEAUX FORBICI

Scheren mit Hartmetalleinlagen
 Scissors with Tungsten Carbide Inserts
 Tijeras con filos de carburo de tungsteno
 Ciseaux avec plaquettes en carbure de tungstène
 Forbici con taglio al carburo di tungsteno

AA

AB

AC

AD

AE

AF

AK

AL

AO

AP

AR

KB

KI

KC

KU

KYE

X



AC 984/11*
 11,5 cm/4 1/2"



AC 985/11*
 11,5 cm/4 1/2"

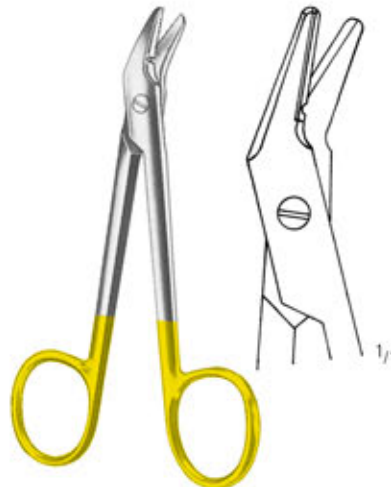

UNIVERSAL
 AC 987/12
 12,0 cm/4 3/4"



LISTER
 AC 999/18
 18,0 cm/7"

SKALPELLE
SCALPELS
BISTURIES
BISTOURIS
BISTURI

AD

nopa[®] instruments

Weitere Skalpelle finden Sie in unserem Katalog „Allgemeines Instrumentarium“ in Gruppe AD.

For further scalpels kindly refer to our catalogue „General Instruments“, section AD.

Para bisturios adicionales, por favor consulte nuestro catálogo de „Instrumental de uso general“, grupo AD.

Pour des bistouris supplémentaires, consultez notre catalogue „Instrumentation Generale“, section AD.

Per gli altri bisturi, consultare il nostro catalogo „Strumentazione Generale“, gruppo AD.





nopa[®] instruments



SKALPELLE SCALPELS BISTURIES BISTOURIS BISTURI

Skalpellgriffe
 Scalpel Handles
 Mangos de bisturias
 Manches pour bistouris
 Manici per bisturi



AD 009/03
 No. 3



AD 010/03
 No. 3



AD 010/04
 No. 4



AD 010/05
 No. 5K



AD 020/13
 No. 3L



AD 020/14
 No. 4L



AD 020/15
 No. 5L

AA
 AB
 AC
AD
 AE
 AF
 AG
 AH
 AI
 AJ
 AK
 AL
 AM
 AN
 AO
 AP
 AQ
 AR
 AS
 AT
 AU
 AV
 AW
 AX
 KYE
 KC
 KI
 KB
 AR
 AP
 AO
 AL
 AK
 AF
 AE

AD SKALPELLE SCALPELS BISTURIES BISTOURIS BISTURI

Skalpellgriffe
 Scalpel Handles
 Mangos de bisturios
 Manches pour bistouris
 Manici per bisturi



AD 025/07
 No. 7



AD 027/07
 No. 7K



AD 030/16



AD 031/21



COLLIN
 AD 040/08
 No. 8

hohl
 hollow
 hueco
 creux
 vuoto



COLLIN
 AD 042/09
 No. 9

SKALPELLE SCALPELS BISTURIES BISTOURIS BISTURI

Skalpellklingen
Scalpel Blades
Hojas de bisturias
Lames pour bistouris
Lame per bisturi

passend für die Griffe
for handles
para los mangos
pour les manches
per i manici

AD 009/03
AD 010/03
AD 020/13
AD 025/07
AD 027/07
AD 030/16
AD 040/08



Fig.10
AD 075/10



Fig.11
AD 075/11



Fig.12d
AD 076/12



Fig.15
AD 075/15



Fig.15c
AD 076/15



steril
sterile
estériles
stériles
sterili



Fig.20
AD 075/20



Fig.21
AD 075/21



Fig.22
AD 075/22



Fig.23
AD 075/23



Fig.24
AD 075/24

passend für die Griffe
for handles
para los mangos
pour les manches
per i manici

AD 010/04
AD 020/14
AD 042/09

AA
AB
AC
AD
AE
AF
AK
AL
AO
AP
AR
KB
KI
KC
KU
KYE
X

AD SKALPELLE SCALPELS BISTURIES BISTOURIS BISTURI

Operations-Skalpelle
 Operating Knives
 Bisturies para operaciones
 Bistouris pour opérations
 Bisturi per interventi



14,5 cm/5³/₄"



Fig.1
AD 200/01



Fig.3
AD 200/03



Fig.5
AD 200/05



Fig.7
AD 200/07



Fig.9
AD 200/09



Fig.10
AD 200/10



Fig.12
AD 200/12



Fig.14
AD 200/14



Fig.16
AD 200/16



Fig.18
AD 200/18

SKALPELLE SCALPELS BISTURIES BISTOURIS BISTURI

Operations-Skalpelle
 Operating Knives
 Bisturías para operaciones
 Bistouris pour opérations
 Bisturi per interventi

AA

AB

AC

AD

AE

AF

AK

AL

AO

AP

AR

KB

KI

KC

KU

KYE

X



COLLIN



Fig.1
AD 220/01



Fig.2
AD 220/02



Fig.3
AD 220/03



Fig.4
AD 220/04



Fig.5
AD 220/05



Fig.6
AD 220/06

AD SKALPELLE SCALPELS BISTURIES BISTOURIS BISTURI

Operations-Skalpelle
 Operating Knives
 Bisturios para operaciones
 Bistouris pour opérations
 Bisturi per interventi



Fig.1
AD 250/01



Fig.2
AD 250/02



Fig.3
AD 250/03



Fig.4
AD 250/04



Fig.5
AD 250/05



Fig.6
AD 250/06



Fig.7
AD 250/07



Fig.8
AD 250/08



Fig.9
AD 250/09



Fig.15
AD 250/15



Fig.16
AD 250/16

DIEFFENBACH

SKALPELLE SCALPELS BISTURIES BISTOURIS BISTURI

Abszessmesser, Fistelmesser
 Abscess Knives, Fistula Knives
 Bisturies para abscesos y fistulas
 Bistouris à abcès et fistules
 Bisturi per ascessi e fistole



DIEFFENBACH
 AD 400/13
 13,0 cm/5"



DIEFFENBACH
 AD 401/13
 13,0 cm/5"



SIMON
 23,5 cm/9 1/3"



Fig. 1
 AD 430/01



Fig. 2
 AD 430/02



Fig. 3
 AD 430/03



Fig. 4
 AD 430/04

AA
 AB
 AC
AD
 AE
 AF
 AG
 AH
 AI
 AJ
 AK
 AL
 AM
 AN
 AO
 AP
 AQ
 AR
 AS
 AT
 AU
 AV
 AW
 AX

NAHT
SUTURE
SUTURA
SUTURE
SUTURA

AE

nopa[®] instruments

Weitere Naht-Instrumente finden Sie in unserem Katalog „Allgemeines Instrumentarium“ in Gruppe AE.

For further suture instruments kindly refer to our catalogue „General Instruments“, section AE.

Para instrumentos de sutura adicionales, por favor consulte nuestro catálogo de „Instrumental de uso general“, grupo AE.

Pour des instruments de suture supplémentaires, consultez notre catalogue „Instrumentation Generale“, section AE.

Per gli altri accessori di sutura, consultare il nostro catalogo „Strumentazione Generale“, gruppo AE.



AE NAHT SUTURE SUTURA SUTURE SUTURA

Nadelhalter
Needle Holders
Porta-agujas
Porte-aiguilles
Portaghi



MAYO-HEGAR



AE 100/14 14,0 cm/5¹/₂" AE 100/16 16,0 cm/6¹/₄" AE 100/18 18,0 cm/7"
AE 100/20 20,0 cm/8" AE 100/24 24,0 cm/9¹/₂"

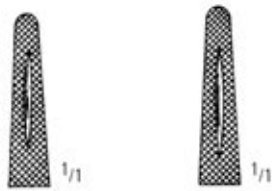

AE 100/26 26,0 cm/10¹/₄" AE 100/30 30,0 cm/12"

MAYO-HEGAR-DELICATE

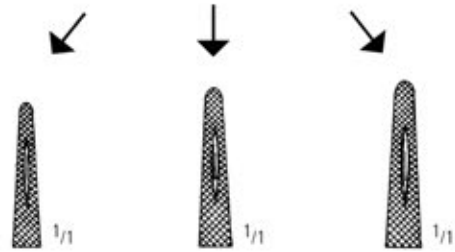

AE 110/16 16,0 cm/6¹/₄" AE 110/18 18,0 cm/7"
AE 110/20 20,0 cm/8"

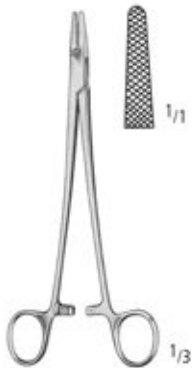

BAUMGARTNER
AE 112/14
14,0 cm/5¹/₂"



HEANEY
AE 113/21
21,0 cm/8¹/₄"



JAMESON
AE 126/23
23,5 cm/9¹/₃"



MASSON
AE 130/27
27,0 cm/10³/₄"

NAHT SUTURE SUTURA SUTURE SUTURA

Nadelhalter
Needle Holders
Porta-agujas
Porte-aiguilles
Portaghi

AA
AB
AC
AD
AE
AF
AK
AL
AO
AP
AR
KB
KI
KC
KU
KYE
X



FINOCCHIETTO
AE 136/27
27,0 cm/10³/₄"



WANGENSTEEN
AE 140/27
27,0 cm/10³/₄"



WANGENSTEEN-DELICATE
AE 142/27
27,5 cm/10¹/₂"

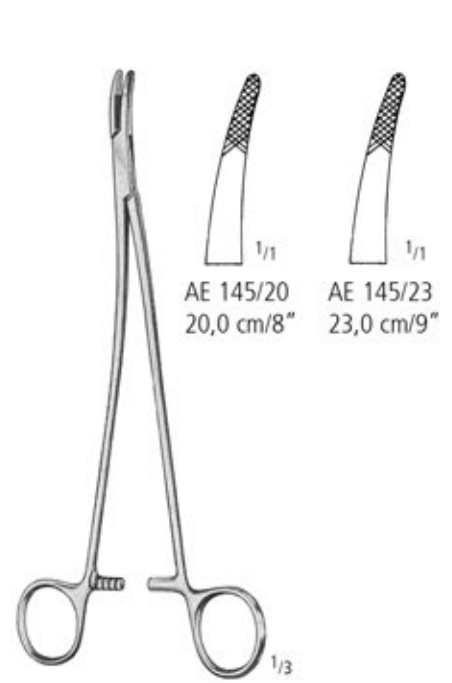

STRATTE

AE 145/20
20,0 cm/8"

AE 145/23
23,0 cm/9"

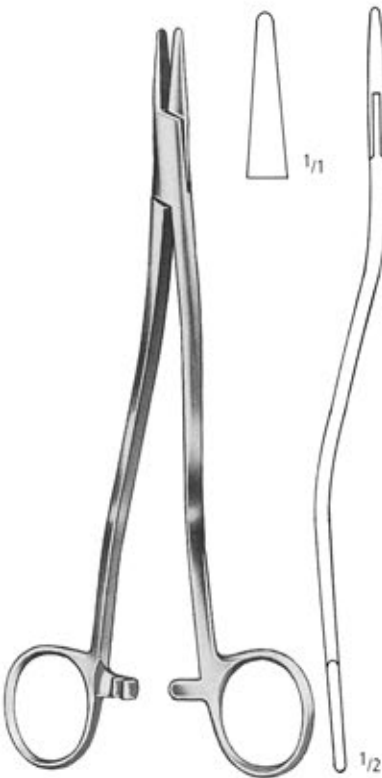

WERTHEIM
20,0 cm/8" AE 147/20
24,0 cm/9¹/₂" AE 147/24

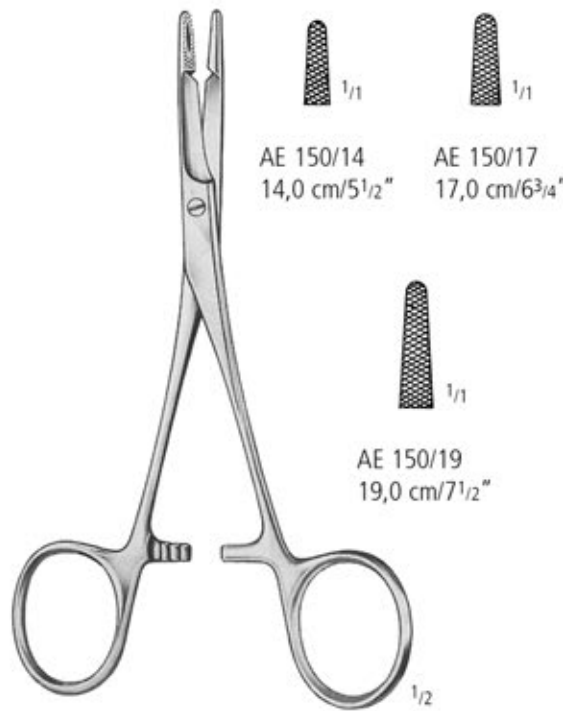

OLSEN-HEGAR

AE 150/14
14,0 cm/5¹/₂"

AE 150/17
17,0 cm/6³/₄"

AE 150/19
19,0 cm/7¹/₂"

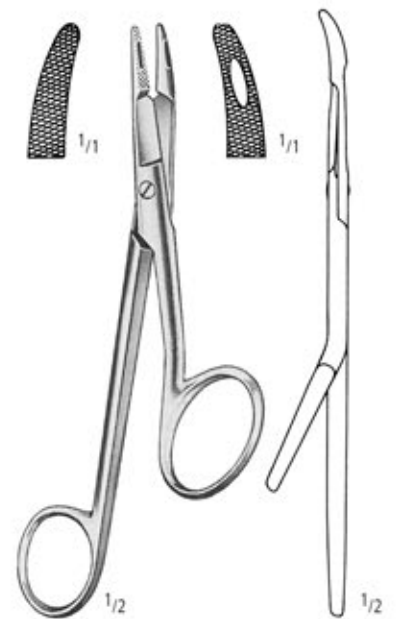

GILLIES
AE 155/16
16,0 cm/6¹/₄"

AE NAHT SUTURE SUTURA SUTURE SUTURA

Nadelhalter
Needle Holders
Porta-agujas
Porte-aiguilles
Portaghi



MATHIEU



AE 200/14
14,0 cm/5 1/2"



AE 200/17
17,0 cm/6 3/4"



AE 200/20
20,0 cm/8"



AE 200/24
24,0 cm/9 1/2"



MATHIEU-DELICATE



AE 210/14
14,0 cm/5 1/2"



AE 210/17
17,0 cm/6 3/4"



MATHIEU



AE 214/17
17,0 cm/6 3/4"



AE 214/20
20,0 cm/8"



AE 214/24
24,0 cm/9 1/2"

Nadelhalter
Needle Holders
Porta-agujas
Porte-aiguilles
Portaghi

AA

AB

AC

AD

AE

AF

AK

AL

AO

AP

AR

KB

KI

KC

KU

KYE

X



YOUNG-MILLIN

AE 300/20

20,0 cm/8"

mit 1 Nadel AE 301/01
with 1 needle AE 301/01
con 1 aguja AE 301/01
avec 1 aiguille AE 301/01
con 1 ago AE 301/01



YOUNG-HRYNTSCHAK

AE 300/24

24,0 cm/9¹/₂"

mit 1 Nadel AE 301/01
with 1 needle AE 301/01
con 1 aguja AE 301/01
avec 1 aiguille AE 301/01
con 1 ago AE 301/01



AE 301/01



AE 301/02



AE 301/03

AE NAHT SUTURE SUTURA SUTURE SUTURA

Hartmetalleinsatzplättchen mit Pyramidenprofil
 Tungsten Carbide Tips with pyramidal profile
 Bocas de carburo de tungsteno con perfil de estructura piramidal
 Plaquettes en carbure de tungstène avec profil pyramidal
 Placche di carburo di tungsteno con profilo in forma piramidale

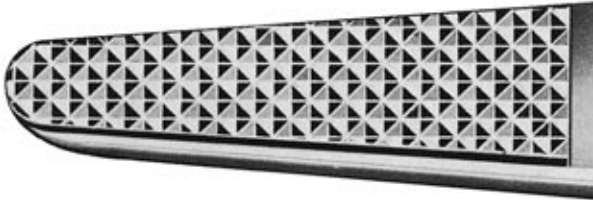

Teilung:	0,5 mm	Für Nahtmaterial 3/0 und größer
Serration:	0,5 mm	For suture sizes 3/0 and larger
Graduación:	0,5 mm	Para sutura 3/0 y más grande
Graduation:	0,5 mm	Pour suture 3/0 et plus grand
Graduazione:	0,5 mm	Per sutura 3/0 e più grande

"STANDARD"

(Mayo-Hegar, Mathieu, Bozeman,
 New Orleans, Stratte, etc.)

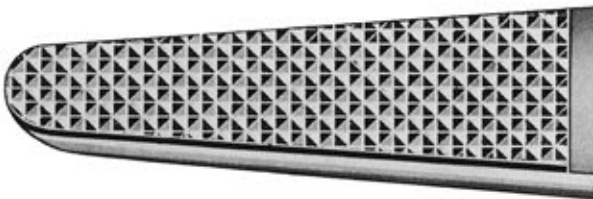

Teilung:	0,4 mm	Für Nahtmaterial zwischen 3/0 und 6/0
Serration:	0,4 mm	For sutures sizes between 3/0 and 6/0
Graduación:	0,4 mm	Para suturas entre 3/0 y 6/0
Graduation:	0,4 mm	Pour sutures entre 3/0 et 6/0
Graduazione:	0,4 mm	Per sutura tra 3/0 e 6/0

"FINE"

(Crile-Wood, Halsey, DeBakey, Ryder,
 etc.)

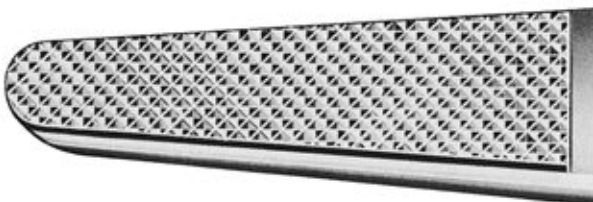

Teilung:	0,2 mm	Für Nahtmaterial zwischen 7/0 und 10/0
Serration:	0,2 mm	For sutures sizes between 7/0 and 10/0
Graduación:	0,2 mm	Para suturas entre 7/0 y 10/0
Graduation:	0,2 mm	Pour sutures entre 7/0 et 10/0
Graduazione:	0,2 mm	Per sutura tra 7/0 e 10/0

"MICRO"

(Micro Ryder, Microvascular, Castroviejo,
 etc.)



glatt	Für extrem feines Nahtmaterial
smooth	For the smallest suture sizes available
lisa	Para suturas extremamente finas
lisses	Pour matériel de suture extrêmement fin
liscio	Per materiale di sutura finissima

"SMOOTH"

(Eufrate Pasqué, Castroviejo, Jacobson, etc.)

NAHT SUTURE SUTURA SUTURE SUTURA

nopa-Service, Ersatzteile und Aufarbeitung aller Fabrikate
 nopa-Service, Spare Inserts and Refurbishing of all brands
 Servicio-nopa, piezas de recambio y renovar de todas las marcas
 Service-nopa, pièces de rechange et remise à neuf de toutes les marques
 Servizio-nopa, pezzi di ricambio e riparazione di tutte le marche

TUC-Einsätze
TUC-Inserts
TUC-Bocas
TUC-Plaquettes
TUC-Placche

AE 380/15	Smooth, 15 mm
AE 380/17	Smooth, 17 mm
AE 380/19	Smooth, 19 mm
AE 382/15	Micro, 0.2, 15 mm
AE 382/17	Micro, 0.2, 17 mm
AE 382/19	Micro, 0.2, 19 mm
AE 384/15	Fine, 0.4, 15 mm
AE 384/17	Fine, 0.4, 17 mm
AE 384/19	Fine, 0.4, 19 mm
AE 385/15	Standard, 0.5, 15 mm
AE 385/17	Standard, 0.5, 17 mm
AE 385/19	Standard, 0.5, 19 mm

Reparaturservice
Repair-Service
Servicio de reparación
Service de réparation
Servizio di riparazione

AE 390/00
 neue Plättchen einsetzen, aufarbeiten, Ringe vergolden
 replacement of inserts, refurbishing, gold handles refinished
 soldar bocas nuevas, reparar, dorar los anillos
 brasage des nouvelles plaquettes, remise à neuf, redorer les anneaux
 saldare placche nuove, rinnovare, dorare gli anelli

AE 390/01
 neue Plättchen einsetzen, aufarbeiten
 replacement of inserts, refurbishing
 soldar bocas nuevas, reparar
 brasage des nouvelles plaquettes, remise à neuf
 saldare placche nuove, rinnovare

AE 390/02
 neue Plättchen einsetzen
 replacement of inserts
 soldar bocas nuevas
 brasage des nouvelles plaquettes
 saldare placche nuove

AE 390/03
 aufarbeiten
 refurbishing
 reparar
 remise à neuf
 rinnovare

AE 390/04
 Ringe vergolden
 gold handles refinished
 dorar los anillos
 redorer les anneaux
 dorare gli anelli

AA

AB

AC

AD

AE

AF

AK

AL

AO

AP

AR

KB

KI

KC

KU

KYE

X

AE NAHT SUTURE SUTURA SUTURE SUTURA

Nadelhalter mit Hartmetalleinsätzen
 Needle Holders with Tungsten Carbide Inserts
 Porta-agujas con bocas de carburo de Tungsteno
 Porte-aiguilles à mors en carbure de tungstène
 Portaghi con placche di carburo di tungsteno



MAYO-HEGAR



AE 400/14
14,0 cm/5½"



AE 400/16
16,0 cm/6¼"



AE 400/18
18,0 cm/7"



AE 400/20
20,0 cm/8"



AE 400/24
24,0 cm/9½"



AE 400/26
26,0 cm/10½"



AE 400/30
30,0 cm/12"

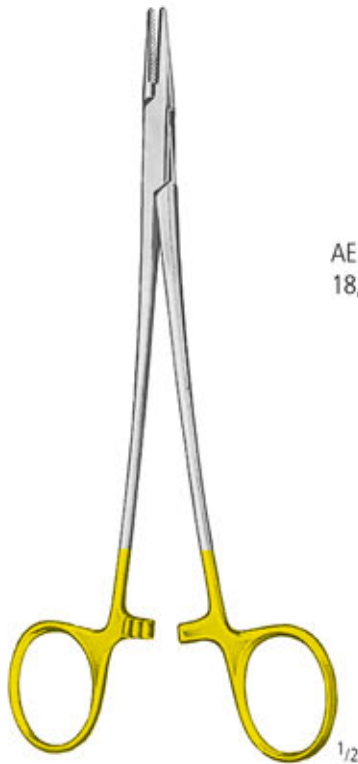

**DE-BAKEY
 (MAYO-HEGAR-DELICATE)**



AE 420/18
18,0 cm/7"



AE 420/20
20,0 cm/8"



AE 420/23
23,0 cm/9"



AE 420/26
26,0 cm/10½"



AE 420/31
31,0 cm/12¼"

NAHT SUTURE SUTURA SUTURE SUTURA

Nadelhalter mit Hartmetalleinsätzen
 Needle Holders with Tungsten Carbide Inserts
 Porta-agujas con bocas de carburo de Tungsteno
 Porte-aiguilles à mors en carbure de tungstène
 Portaghi con placche di carburo di tungsteno



RYDER/FRENCH-EYE

AE 430/13 13,0 cm/5"	AE 430/15 15,0 cm/6"	AE 430/18 18,0 cm/7"	AE 430/20 20,0 cm/8"	AE 430/23 23,0 cm/9"	AE 430/26 26,0 cm/10 ¹ / ₂ "

MICRO RYDER

AE 434/13 13,0 cm/5"	AE 434/15 15,0 cm/6"	AE 434/18 18,0 cm/7"	AE 434/20 20,0 cm/8"	AE 434/23 23,0 cm/9"	AE 434/26 26,0 cm/10 ¹ / ₂ "



AE 436/14 14,0 cm/5 ¹ / ₂ "	AE 436/18 18,0 cm/7"	AE 436/20 20,0 cm/8"	AE 436/23 23,0 cm/9"

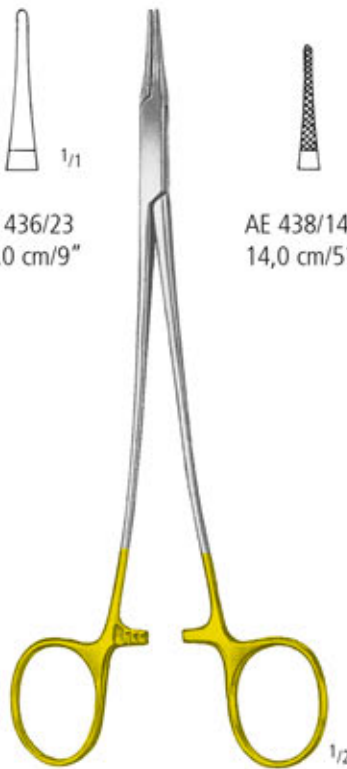

EUFRATE PASQUÉ

extrem fein
 extremely delicate
 muy fino
 très fin
 molto fino

MICROVASCULAR

AE 438/14 14,0 cm/5 ¹ / ₂ "	AE 438/18 18,0 cm/7"	AE 438/20 20,0 cm/8"	AE 438/23 23,0 cm/9"

AA
AB
AC
AD
AE
AF
AK
AL
AO
AP
AR
KB
KI
KC
KU
KYE
X

AE NAHT SUTURE SUTURA SUTURE SUTURA

Nadelhalter mit Hartmetalleinsätzen
 Needle Holders with Tungsten Carbide Inserts
 Porta-agujas con bocas de carburo de Tungsteno
 Porte-aiguilles à mors en carbure de tungstène
 Portaghi con placche di carburo di tungsteno



BABY-CRILE-WOOD
 AE 468/15
 15,0 cm/6"

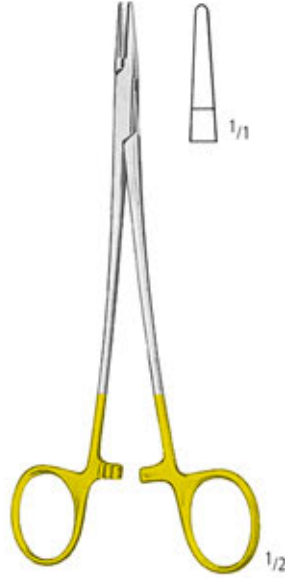

CRILE-WOOD
 AE 469/15
 15,0 cm/6"

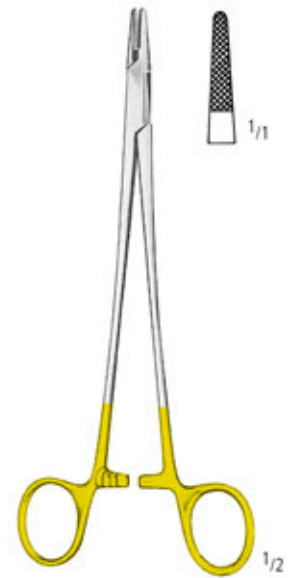

CRILE-WOOD
 AE 470/15
 15,0 cm/6"

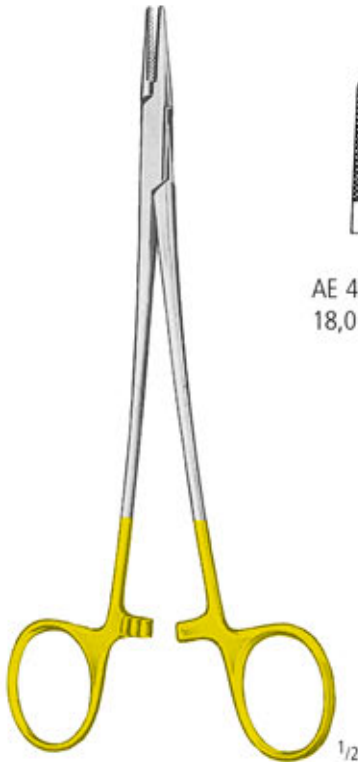

CRILE-WOOD



AE 470/18
 18,0 cm/7"



AE 470/20
 20,0 cm/8"



AE 470/23
 23,0 cm/9"



AE 471/18
 18,0 cm/7"



AE 471/23
 23,0 cm/9"

NAHT SUTURE SUTURA SUTURE SUTURA

Nadelhalter mit Hartmetalleinsätzen
 Needle Holders with Tungsten Carbide Inserts
 Porta-agujas con bocas de carburo de Tungsteno
 Porte-aiguilles à mors en carbure de tungstène
 Portaghi con placche di carburo di tungsteno



SAROT

AE 480/18
 18,0 cm/7"



AE 480/26
 26,0 cm/10 1/2"



MASSON
 AE 482/27
 27,0 cm/10 3/4"



AA

AB

AC

AD

AE

AF

AK

AL

AO

AP

AR

KB

KI

KC

KU

KYE

X

AE NAHT SUTURE SUTURA SUTURE SUTURA

Nadelhalter mit Hartmetalleinsätzen
 Needle Holders with Tungsten Carbide Inserts
 Porta-agujas con bocas de carburo de Tungsteno
 Porte-aiguilles à mors en carbure de tungstène
 Portaghi con placche di carburo di tungsteno

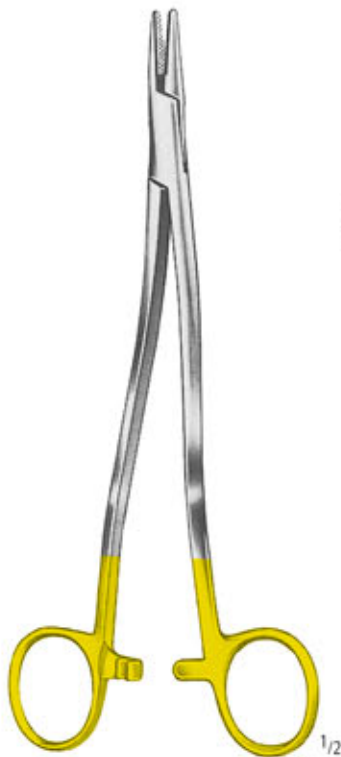

WERTHEIM



AE 487/20
20,0 cm/8"



AE 487/24
24,0 cm/9 1/2"



AE 487/30
30,0 cm/12"



AE 488/14
14,0 cm/5 1/2"



AE 488/17
17,0 cm/6 3/4"



AE 488/19
19,0 cm/7 1/2"



AE 490/16
16,0 cm/6 1/4"



AE 491/16
16,0 cm/6 1/4"

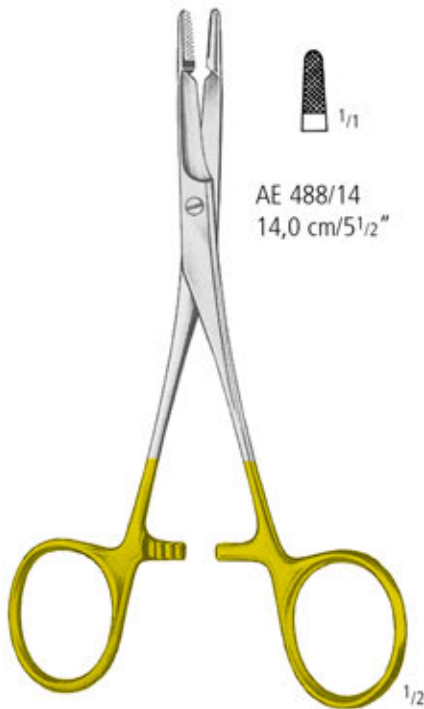

OLSEN-HEGAR

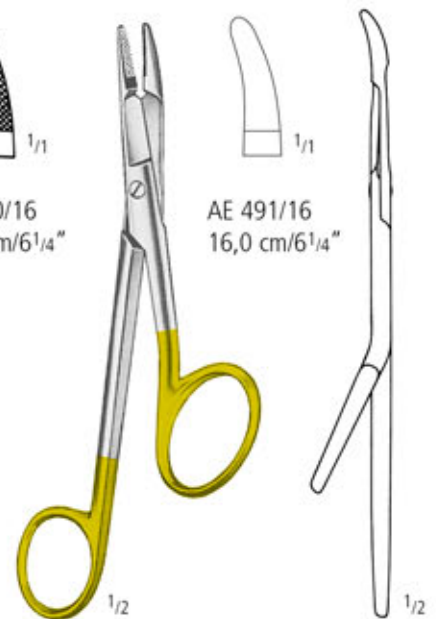

GILLIES

NAHT SUTURE SUTURA SUTURE SUTURA

Nadelhalter mit Hartmetalleinsätzen
 Needle Holders with Tungsten Carbide Inserts
 Porta-agujas con bocas de carburo de Tungsteno
 Porte-aiguilles à mors en carbure de tungstène
 Portaghi con placche di carburo di tungsteno



MATHIEU



AE 500/14
14,0 cm/5 1/2"



AE 500/17
17,0 cm/6 3/4"



AE 500/20
20,0 cm/8"



AE 500/24
24,0 cm/9 1/2"



MATHIEU



AE 501/14
14,0 cm/5 1/2"



MATHIEU



AE 502/17
17,0 cm/6 3/4"



AE 502/20
20,0 cm/8"



AE 502/23
23,0 cm/9"



MATHIEU-DELICATE



AE 504/14
14,0 cm/5 1/2"



AE 504/17
17,0 cm/6 3/4"



AE 504/20
20,0 cm/8"



METZENBAUM



AE 507/17
17,0 cm/6 3/4"



AE 507/19
19,5 cm/7 1/2"

AA
AB
AC
AD
AE
AF
AK
AL
AO
AP
AR
KB
KI
KC
KU
KYE
X

AE NAHT SUTURE SUTURA SUTURE SUTURA

Nadelhalter mit Hartmetalleinsätzen
 Needle Holders with Tungsten Carbide Inserts
 Porta-agujas con bocas de carburo de Tungsteno
 Porte-aiguilles à mors en carbure de tungstène
 Portaghi con placche di carburo di tungsteno



MATHIEU-RYDER



AE 510/17
17,0 cm/6³/₄"



AE 510/20
20,0 cm/8"



AE 510/24
24,0 cm/9¹/₂"



MATHIEU-RYDER VASCULAR



AE 512/17
17,0 cm/6³/₄"



AE 512/20
20,0 cm/8"



AE 512/24
24,0 cm/9¹/₂"

NAHT SUTURE SUTURA SUTURE SUTURA

Mikro-Nadelhalter mit Rundgriff
 Micro-Needle Holders with Pen-Type Handle
 Micro-Porta-agujas con mango redondo
 Micro-Porte-aiguilles à manches rondes
 Micro-Portaghi con manici rotondi



AE 630/18
 18,0 cm/7"



AE 631/18
 18,0 cm/7"



AE 632/18
 18,0 cm/7"



AE 633/18
 18,0 cm/7"

- AA
- AB
- AC
- AD
- AE**
- AF
- AK
- AL
- AO
- AP
- AR
- KB
- KI
- KC
- KU
- KYE
- X

AE NAHT SUTURE SUTURA SUTURE SUTURA

Unterbindungsnaedeln
Ligature Needles
Agujas para ligaduras
Aiguilles à ligatures
Aghi per legatura

DESCHAMPS

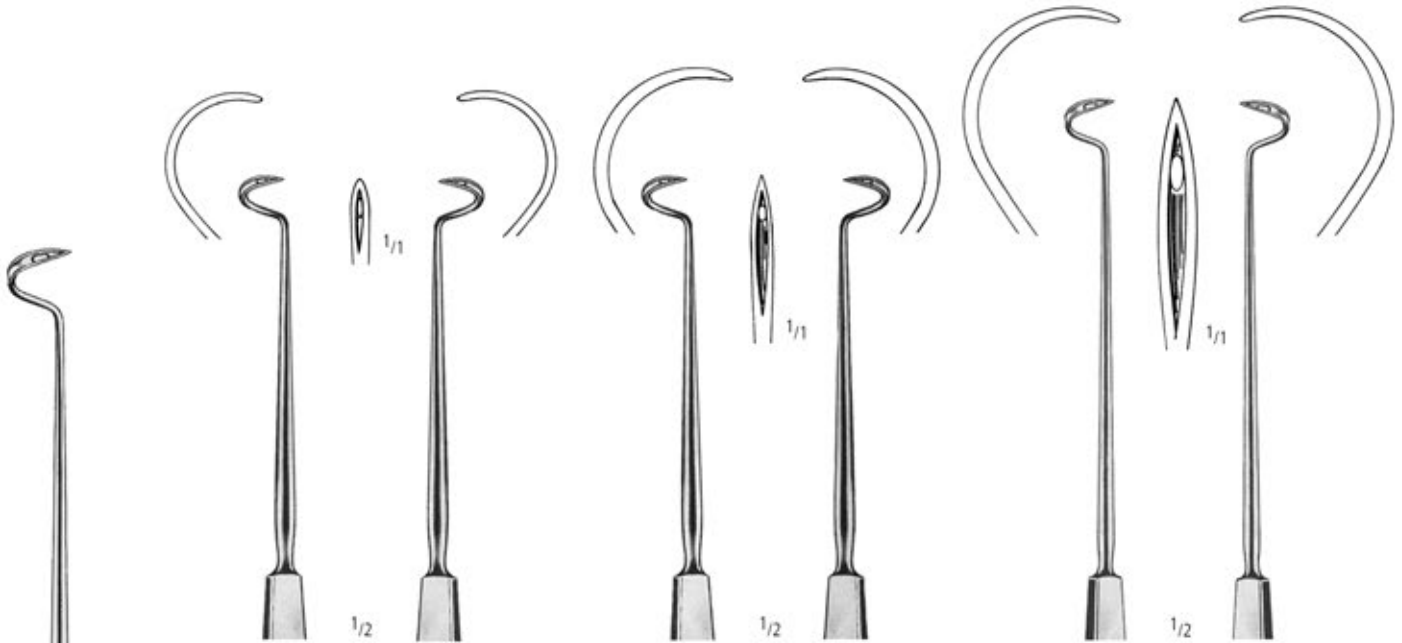

spitz • pointed • agudas • pointues • acuta

20,0 cm/8"	AE 720/20	AE 721/20	AE 722/20	AE 723/20		
21,0 cm/8 ¹ / ₄ "					AE 724/21	AE 725/21
27,0 cm/10 ³ / ₄ "					AE 724/27	AE 725/27

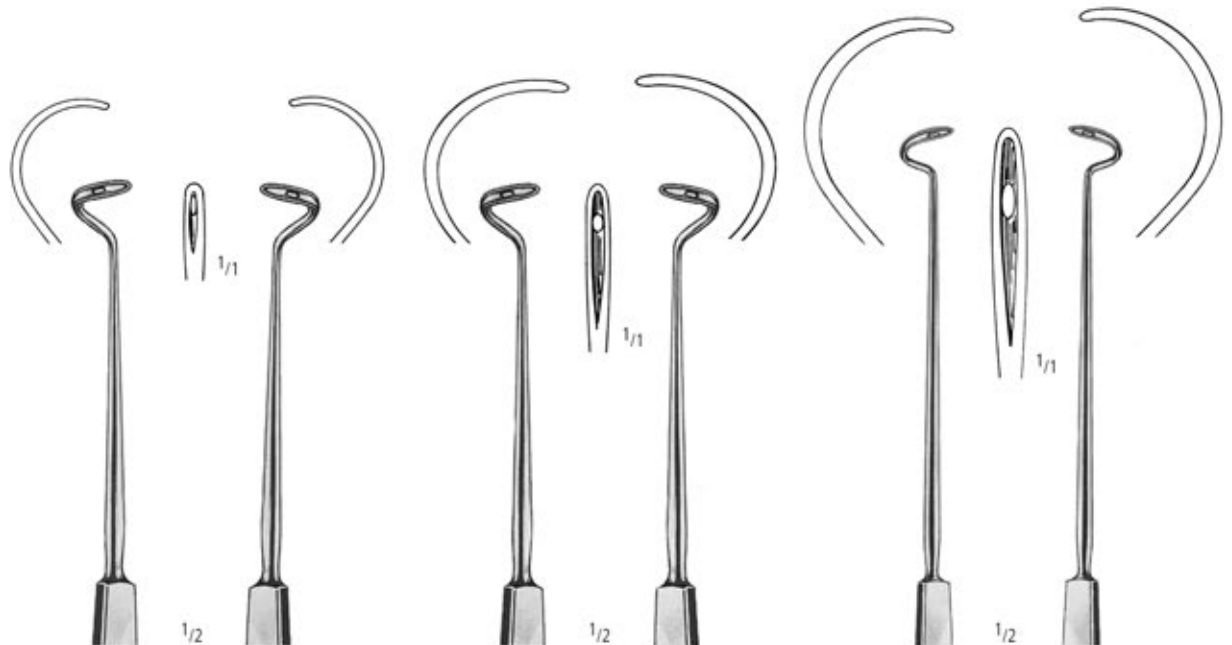

stumpf • blunt • romas • mousses • smussa

20,0 cm/8"	AE 728/20	AE 729/20	AE 730/20	AE 731/20		
21,0 cm/8 ¹ / ₄ "					AE 732/21	AE 733/21
27,0 cm/10 ³ / ₄ "					AE 732/27	AE 733/27

NAHT SUTURE SUTURA SUTURE SUTURA

Unterbindungsnadeln
Ligature Needles
Agujas para ligaduras
Aiguilles à ligatures
Aghi per legatura

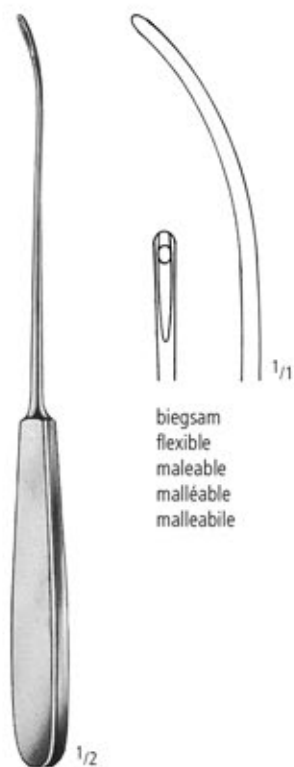

biegsam
flexible
maleable
malléable
malleabile

AE 750/20
20,0 cm/8"

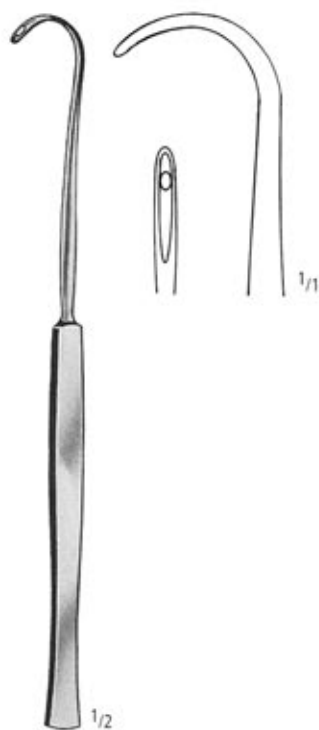

COOPER
AE 751/19
19,0 cm/7½"



COOPER
AE 751/20
20,0 cm/8"

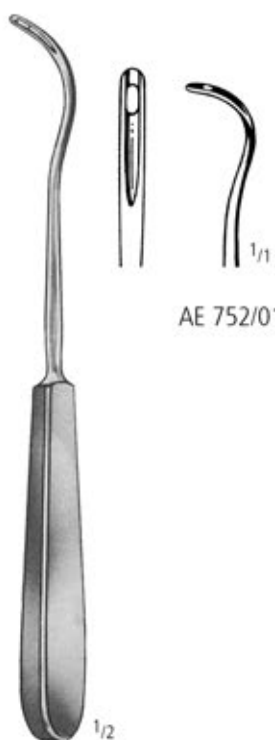

KOCHER
19,0 cm/7½"

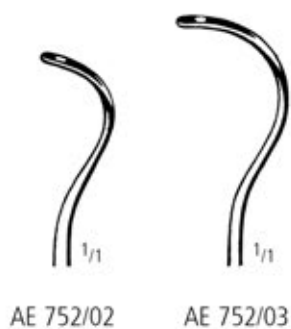

AE 752/01

AE 752/02

AE 752/03

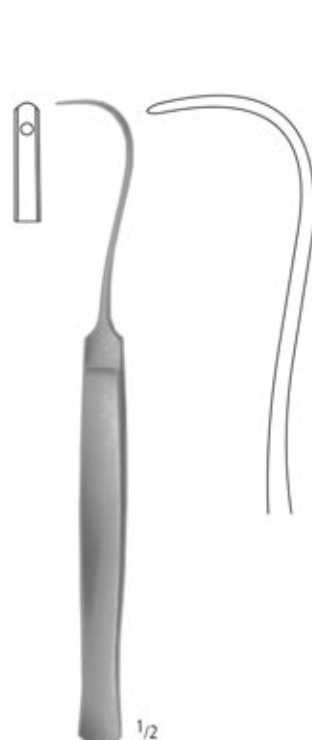

SYME
AE 753/17
17,0 cm/6¾"

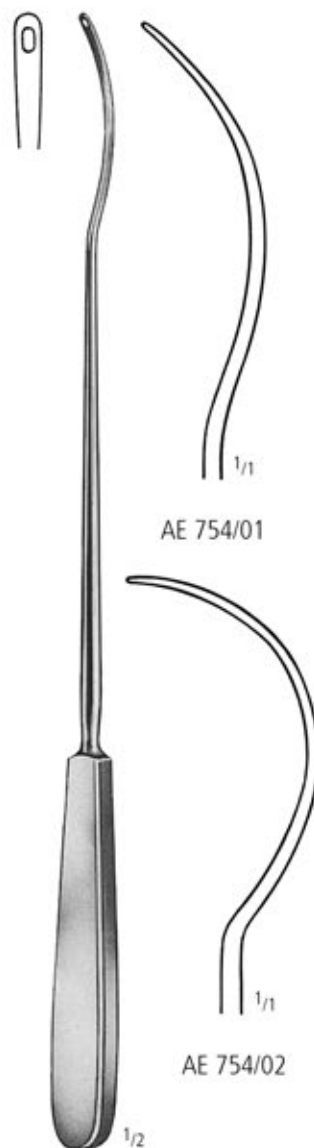

AE 754/01

AE 754/02

BRUNNER
30,0 cm/12"

AA
AB
AC
AD
AE
AF
AK
AL
AO
AP
AR
KB
KI
KC
KU
KYE
X

AE NAHT SUTURE SUTURA SUTURE SUTURA

Unterbindungsadeln
 Ligature Needles
 Agujas para ligaduras
 Aiguilles à ligatures
 Aghi per legatura

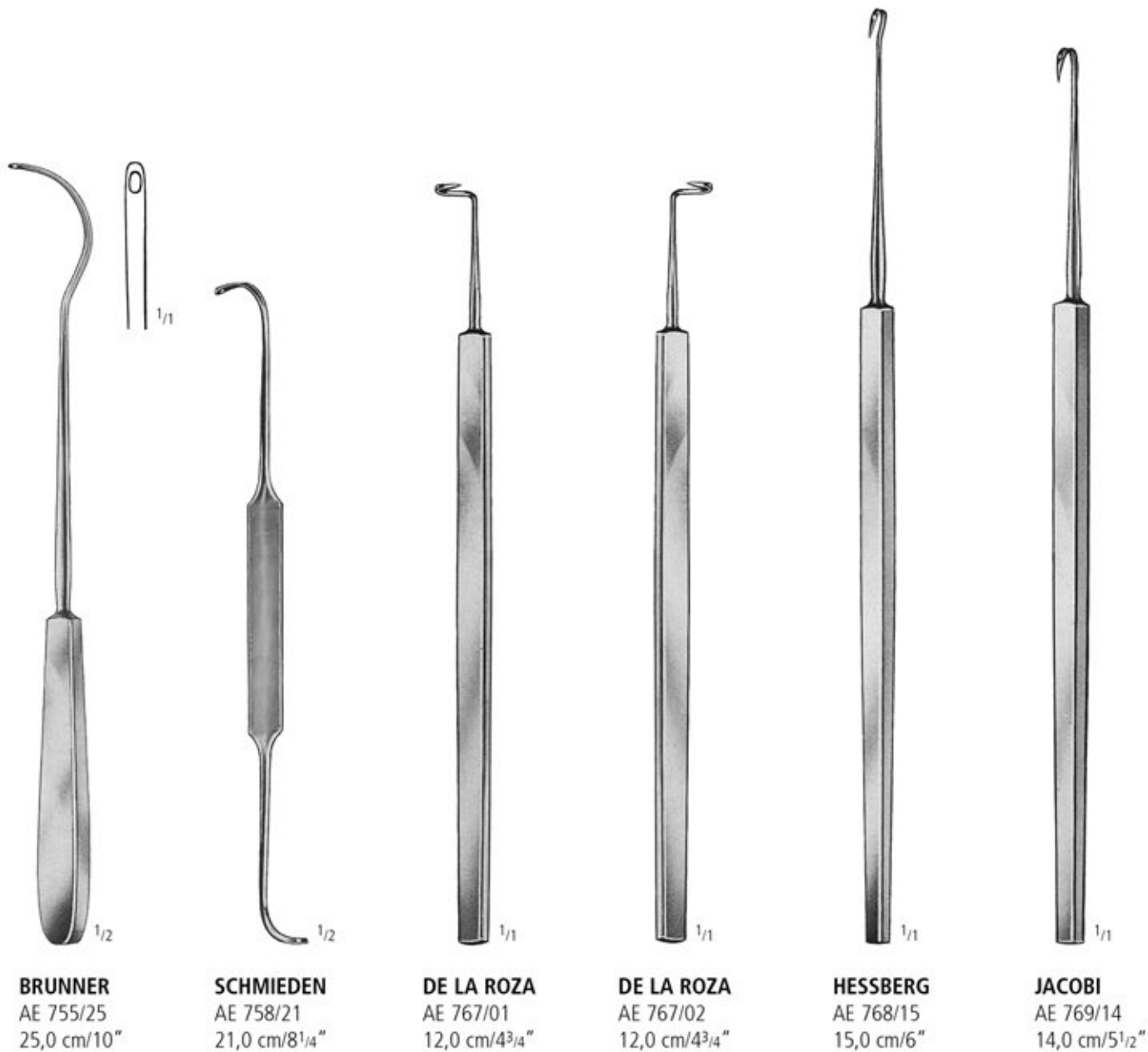

BRUNNER
 AE 755/25
 25,0 cm/10"

SCHMIEDEN
 AE 758/21
 21,0 cm/8¹/₄"

DE LA ROZA
 AE 767/01
 12,0 cm/4³/₄"

DE LA ROZA
 AE 767/02
 12,0 cm/4³/₄"

HESSBERG
 AE 768/15
 15,0 cm/6"

JACOBI
 AE 769/14
 14,0 cm/5¹/₂"

NAHT SUTURE SUTURA SUTURE SUTURA

Unterbindungsnadeln
Ligature Needles
Agujas para ligaduras
Aiguilles à ligatures
Aghi per legatura

AA

AB

AC

AD

AE

AF

AK

AL

AO

AP

AR

KB

KI

KC

KU

KYE

X



KRONECKER
AE 770/01
15,0 cm/6"



KRONECKER
AE 770/02
15,0 cm/6"



TRÉLAT
AE 772/23
23,0 cm/9"



CLAUS
AE 773/23
23,0 cm/9"



HURD
AE 774/01
21,0 cm/8 1/4"



HURD
AE 774/02
21,0 cm/8 1/4"

AE NAHT SUTURE SUTURA SUTURE SUTURA

Unterbindungsnadeln
 Ligature Needles
 Agujas para ligaduras
 Aiguilles à ligatures
 Aghi per legatura



AE 775/01



AE 776/01



AE 775/02



AE 776/02



ROTTER
 26,0 cm/10¹/₂"



ROTTER
 26,0 cm/10¹/₂"



NAGER
 AE 777/24
 24,0 cm/9¹/₂"



FALK
 AE 780/01
 24,0 cm/9¹/₂"



FALK
 AE 780/02
 24,0 cm/9¹/₂"



CLAUS-EICKEN
 AE 781/23
 23,0 cm/9"

NAHT SUTURE SUTURA SUTURE SUTURA

Führungshohlsonden
 Ligature Conductors
 Sondas Conductoras
 Sondes Conductrices
 Sonde conduttrice

AA
 AB
 AC
 AD
 AE
 AF
 AK
 AL
 AO
 AP
 AR
 KB
 KI
 KC
 KU
 KYE
 X



BRUNNER
 30,0 cm/12"



AE 800/01



AE 800/03



AE 800/02



AE 800/04

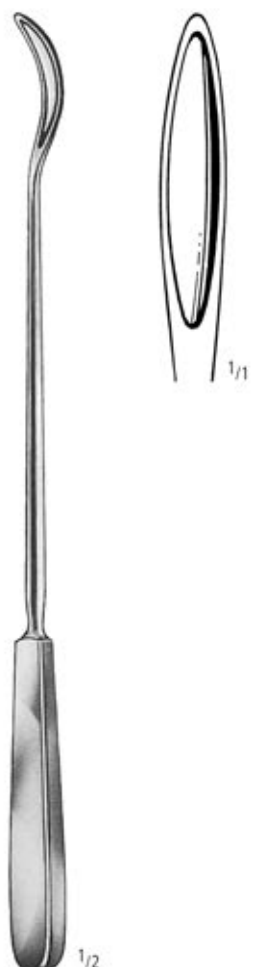

BRUNNER
 AE 801/25
 25,0 cm/10"

AE NAHT SUTURE SUTURA SUTURE SUTURA

Führungshohlsonden
Ligature Conductors
Sondas Conductoras
Sondes Conductrices
Sonde conduttrice



PAYR
AE 802/22
22,0 cm/8³/₄"



PAYR
AE 803/22
22,0 cm/8³/₄"

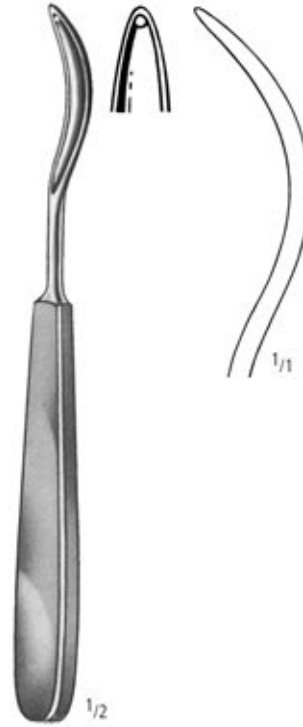

SCHMIEDEN-PAYR
AE 806/19
19,0 cm/7¹/₂"

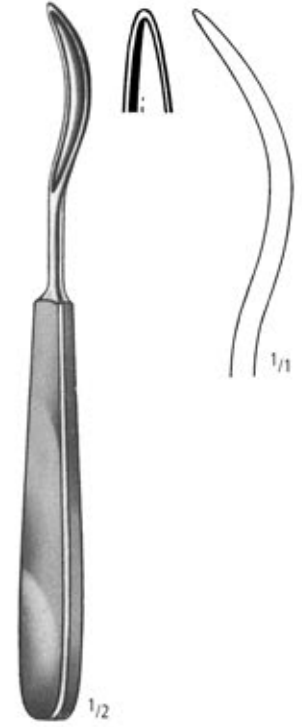

SCHMIEDEN-PAYR
AE 807/19
19,0 cm/7¹/₂"

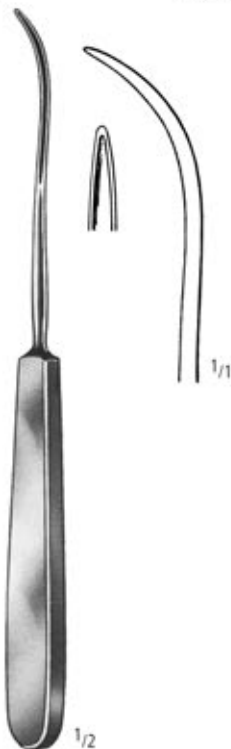

KÖNIG
AE 808/03
19,5 cm/7³/₄"

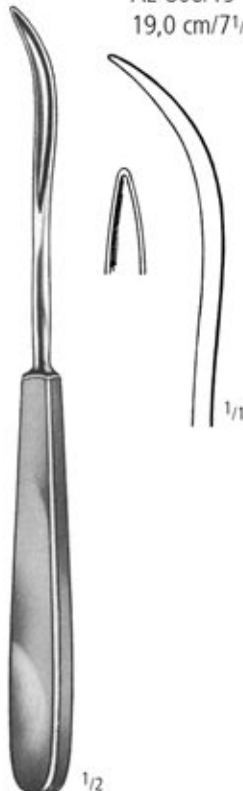

KÖNIG
AE 808/05
19,5 cm/7³/₄"



KÖNIG
AE 808/07
19,5 cm/7³/₄"

NAHT SUTURE SUTURA SUTURE SUTURA

Führungshohlsonden
Ligature Conductors
Sondas Conductoras
Sondes Conductrices
Sonde conductrice

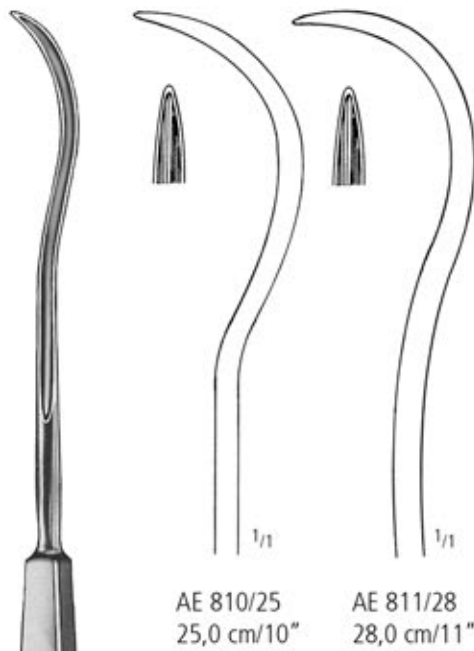

KOCHER

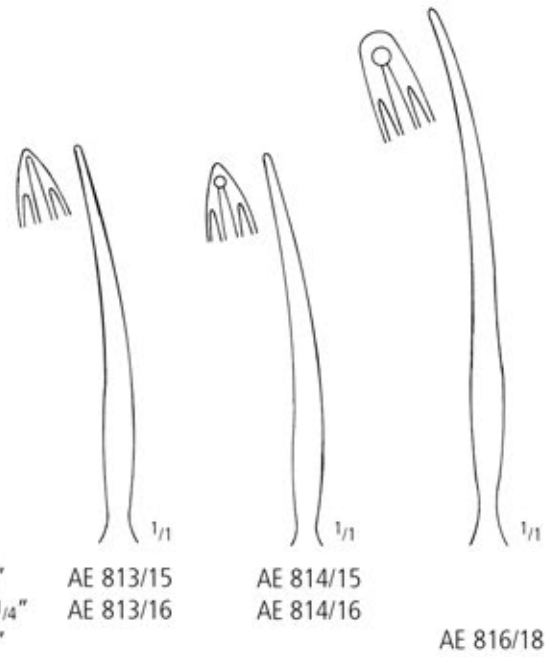

KIRSCHNER



FERROZELL
AE 820/24
24,0 cm/9¹/₂"



BRUNNER-FERROZELL
AE 821/18
18,0 cm/7"

AE 821/27
27,0 cm/10³/₄"



KIRSCHNER-FERROZELL
AE 822/27
27,0 cm/10³/₄"

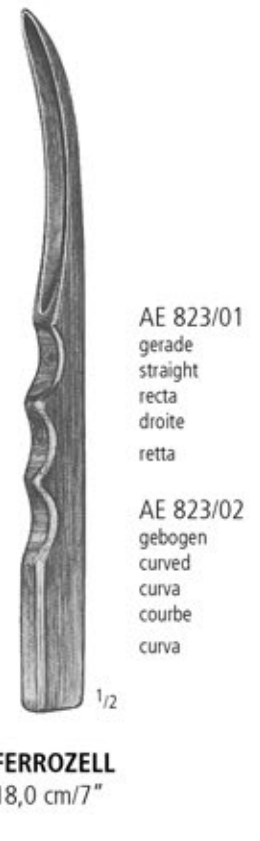

FERROZELL
18,0 cm/7"

AA
AB
AC
AD
AE
AF
AK
AL
AO
AP
AR
KB
KI
KC
KU
KYE
X

Fadenknoter, -fänger, -schlingendreher
 Knot-Tiers, Ligature Catcher, Loop Twisters
 Tuerce-hilos, Porta-ligaduras
 Instruments à noeds, Porte-ligature, Tords-fil
 Strumenti per nodi, Portalegature, Torcifilo

Nahtpinzetten und Fadenscheren
 finden Sie in den Gruppen AB und AC.

For Suture Forceps and Ligature Scissors
 please refer to groups AB and AC.



AE 830/23
 23,0 cm/9"



BOZEMANN
 AE 831/21
 21,0 cm/8¹/₄"



MOD. WIEN
 AE 832/23
 23,5 cm/9¹/₃"



FRIEDRICH
 AE 833/16
 16,0 cm/6¹/₄"

TUPFERZANGEN
SPONGE FORCEPS
PINZAS PARA POLIPOS
PINCES A PANSEMENTS
PINZE PER POLIPI

AF

nopa[®] instruments

Weitere Tupferzangen finden Sie in unserem Katalog „Allgemeines Instrumentarium“ in Gruppe AF.

For further sponge forceps kindly refer to our catalogue „General Instruments“, section AF.

Para pinzas para polipos, por favor consulte nuestro catálogo de „Instrumental de uso general“, grupo AF.

Pour pincés a pansements, consultez notre catalogue „Instrumentation Generale“, section AF.

Per le altre pinze per polipi, consultare il nostro catalogo „Strumentazione Generale“, gruppo AF.



Korn- und Tupferzangen, Schwammzangen
 Polypus and Dressing Forceps, Sponge Holding Forceps
 Pinzas para pólipos, tapones y esponjas
 Pincas à pansements, à tampons et à éponges
 Pinze per polipi, tamponi e spugne

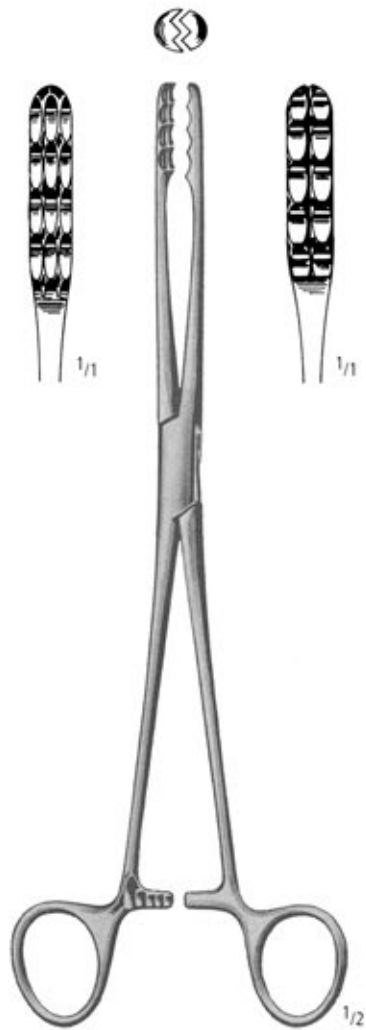

ULRICH
 AF 070/22
 AF 070/25

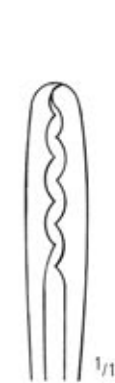

22,0 cm/8³/₄"
 25,0 cm/10"

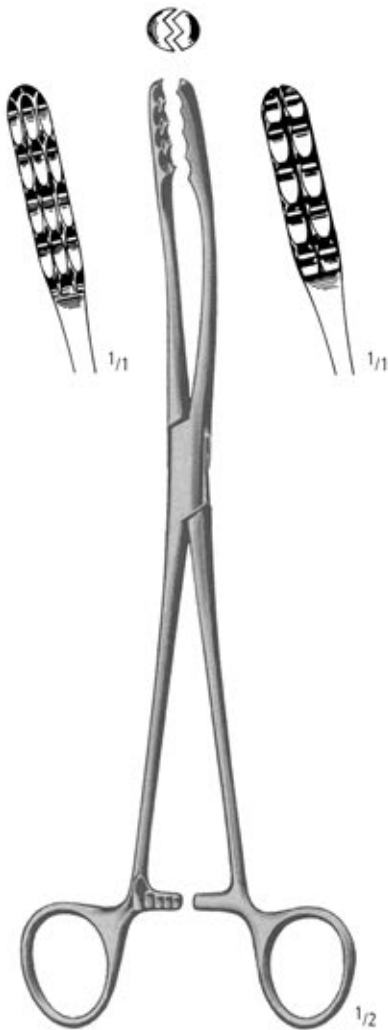

ULRICH
 AF 071/22
 AF 071/25

Korn- und Tupferzangen, Schwammzangen
 Polypus and Dressing Forceps, Sponge Holding Forceps
 Pinzas para pólipos, tapones y esponjas
 Pincas à pansements, à tampons et à éponges
 Pinze per polipi, tamponi e spugne



GROSS-MAIER

- AF 100/20
- AF 100/22
- AF 100/25
- AF 100/27

- 20,0 cm/8"
- 22,0 cm/8³/₄"
- 25,0 cm/10"
- 27,0 cm/10³/₄"

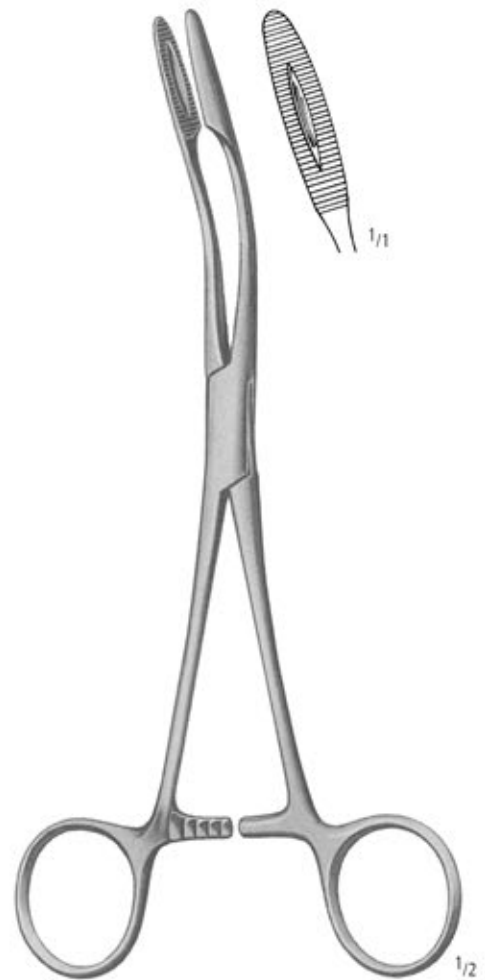

GROSS-MAIER

- AF 101/20
- AF 101/22
- AF 101/25
- AF 101/27

Korn- und Tupferzangen, Schwammzangen
 Polypus and Dressing Forceps, Sponge Holding Forceps
 Pinzas para pólipos, tapones y esponjas
 Pincas à pansements, à tampons et à éponges
 Pinze per polipi, tamponi e spugne

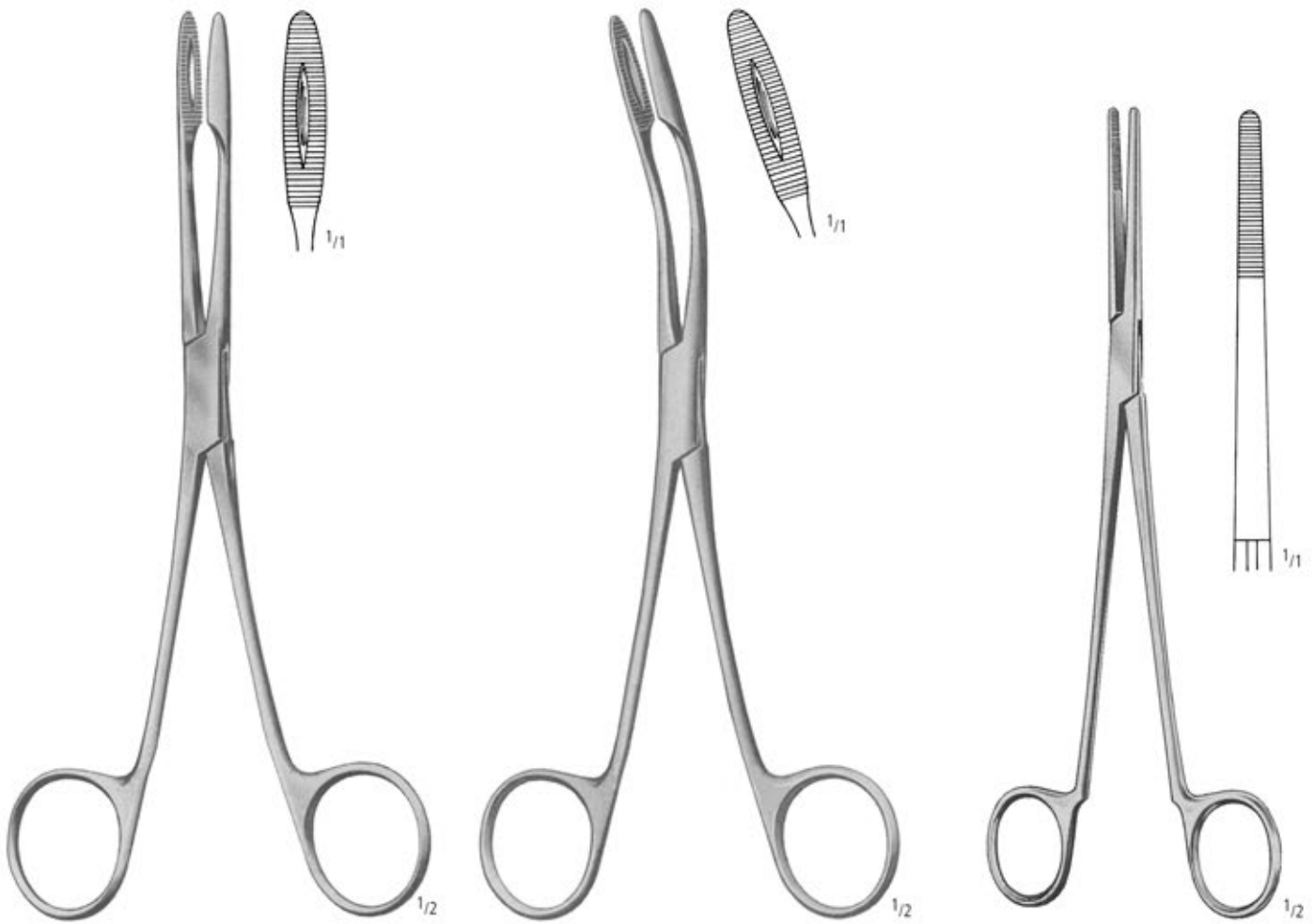

GROSS-MAIER

- AF 102/20 20,0 cm/8"
- AF 102/22 22,0 cm/8³/₄"
- AF 102/25 25,0 cm/10"
- AF 102/27 27,0 cm/10³/₄"

GROSS-MAIER

- AF 103/20
- AF 103/22
- AF 103/25
- AF 103/27

WESTERMARK

- AF 130/23
- 23,0 cm/9"

Korn- und Tupferzangen, Schwammzangen
 Polypus and Dressing Forceps, Sponge Holding Forceps
 Pinzas para pólipos, tapones y esponjas
 Pincas à pansements, à tampons et à éponges
 Pinze per polipi, tamponi e spugne



BOZEMANN
 AF 132/26
 26,0 cm/10¹/₂"

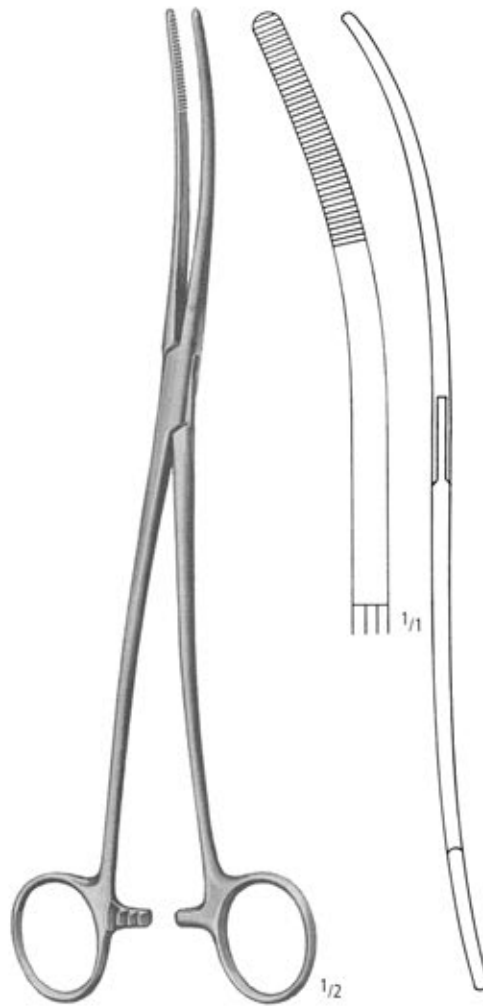

BOZEMANN
 AF 135/26
 26,0 cm/10¹/₂"

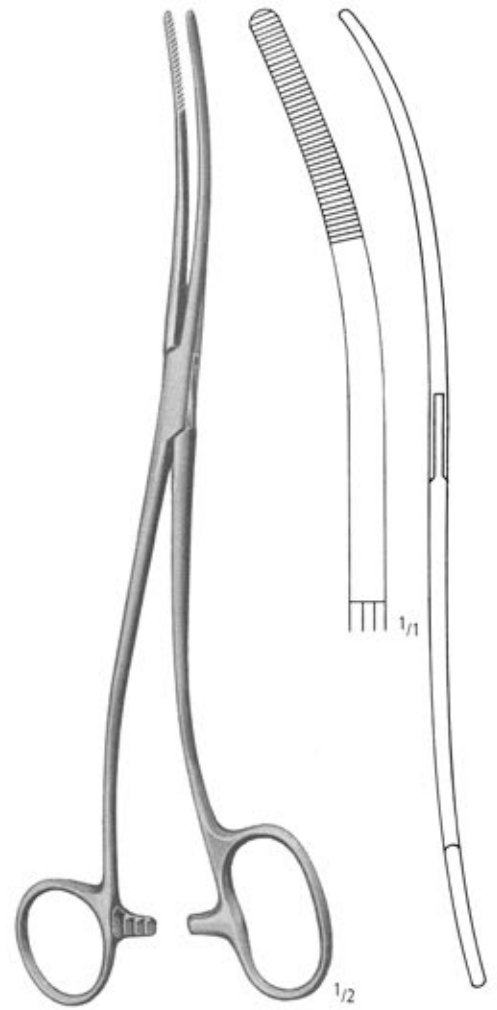

BOZEMANN-DOUGLAS
 AF 137/26
 26,0 cm/10¹/₂"

AA
 AB
 AC
 AD
 AE
AF
 AK
 AL
 AO
 AP
 AR
 KB
 KI
 KC
 KU
 KYE
 X

Korn- und Tupferzangen
Polypus and Dressing Forceps
Pinzas para pólipos
Pinces à pansements
Pinze per polipi

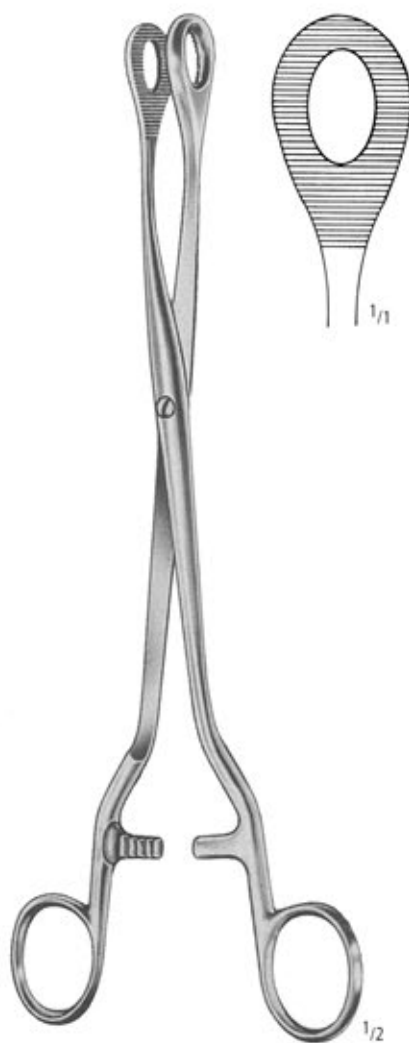

NOTO
AF 146/28
27,5 cm/10³/₄"

Korn- und Tupferzangen, Schwammzangen
 Polypus and Dressing Forceps, Sponge Holding Forceps
 Pinzas para pólipos, tapones y esponjas
 Pincas à pansements, à tampons et à éponges
 Pinze per polipi, tamponi e spugne



PELKMANN
 AF 154/25
 25,0 cm/10"



PELKMANN
 AF 155/25
 25,0 cm/10"



KELLY
 AF 161/32
 32,0 cm/12³/₄"

Korn- und Tupferzangen, Schwammzangen
 Polypus and Dressing Forceps, Sponge Holding Forceps
 Pinzas para pólipos, tapones y esponjas
 Pinces à pansements, à tampons et à éponges
 Pinze per polipi, tamponi e spugne



FOERSTER-BALLENGER



AF 200/18
 AF 200/20



AF 201/18
 AF 201/20

18,0 cm/7"
 20,0 cm/8"



AF 202/18
 AF 202/20



AF 203/18
 AF 203/20

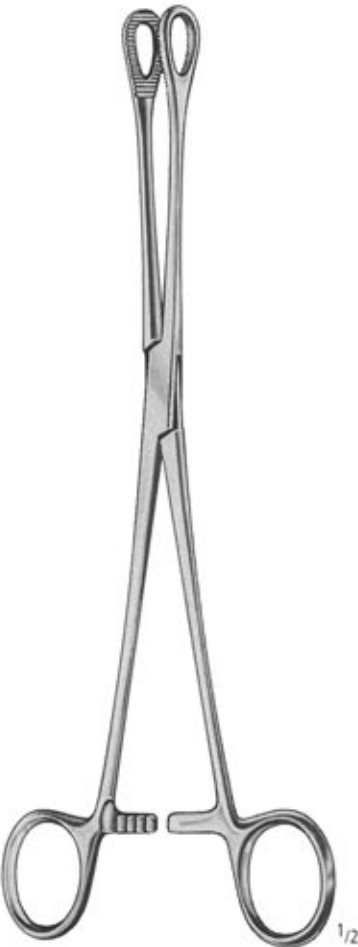

FOERSTER-BALLENGER

25,0 cm/10"



AF 200/25



AF 201/25



AF 202/25



AF 203/25

WUNDHAKEN
RETRACTORS
SEPARADORES
ECARTEURS
DIVARICATORI

AK

nopa[®] instruments

Weitere Wundhaken finden Sie in unserem Katalog „Allgemeines Instrumentarium“ in Gruppe AK.

For further retractors kindly refer to our catalogue „General Instruments“, section AK.

Para separadores adicionales, por favor consulte nuestro catálogo de „Instrumental de uso general“, grupo AK.

Pour d'ecarteurs supplémentaires, consultez notre catalogue „Instrumentation Generale“, section AK.

Per gli altri divaricatori, consultare il nostro catalogo „Strumentazione Generale“, gruppo AK.



AK WUNDHAKEN RETRACTORS SEPARADORES ECARTEURS DIVARICATORI

Feine Wundhaken
Delicate Hooks
Ganchos
Crochets très fins
Divaricatori sottili



CUSHING
28,0 cm/11"



AK 034/01



AK 034/02



CUSHING
19,0 cm/7 1/2"



AK 036/01



AK 036/02

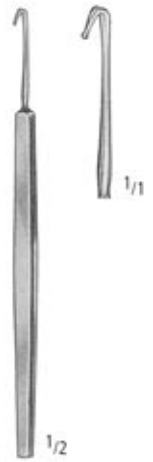

MOLDESTAD
AK 038/13
13,0 cm/5"



AK 040/05
5 mm



AK 040/07
7 mm

17,0 cm/6 3/4"



18,5 cm/7 1/3"



AK 042/10
Ø 1,0 mm



AK 042/12
Ø 1,2 mm

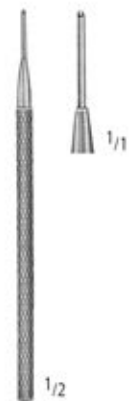

AK 044/11
11,0 cm/4 1/3"

WUNDHAKEN RETRACTORS SEPARADORES ECARTEURS DIVARICATORI

Feine Wundhaken
Delicate Hooks
Ganchos
Crochets très fins
Divaricatori sottili



AA
AB
AC
AD
AE
AF
AK
AL
AO
AP
AR
KB
KI
KC
KU
KYE
X

AK WUNDHAKEN RETRACTORS SEPARADORES ECARTEURS DIVARICATORI

Feine Wundhaken
Delicate Hooks
Ganchos
Crochets très fins
Divaricatori sottili

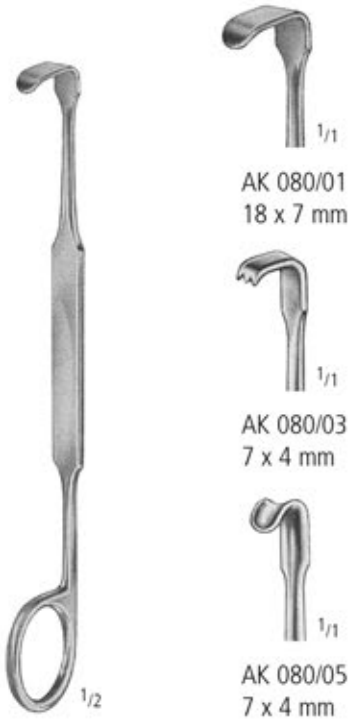

MEYERDING
18,0 cm/7"

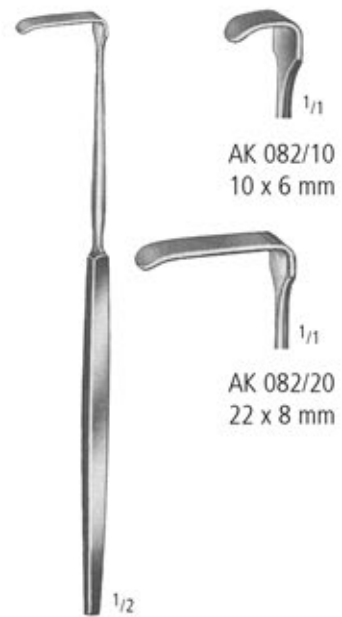

SENN-GREEN
15,0 cm/6"

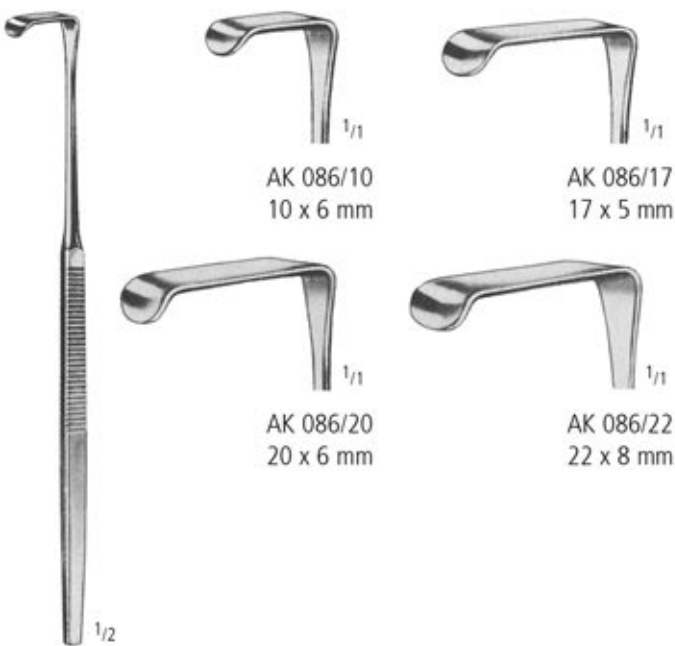

MINI-LANGENBECK
16,0 cm/6¹/₄"

WUNDHAKEN RETRACTORS SEPARADORES ECARTEURS DIVARICATORI

Feine Wundhaken
Delicate Hooks
Ganchos
Crochets très fins
Divaricatori sottili

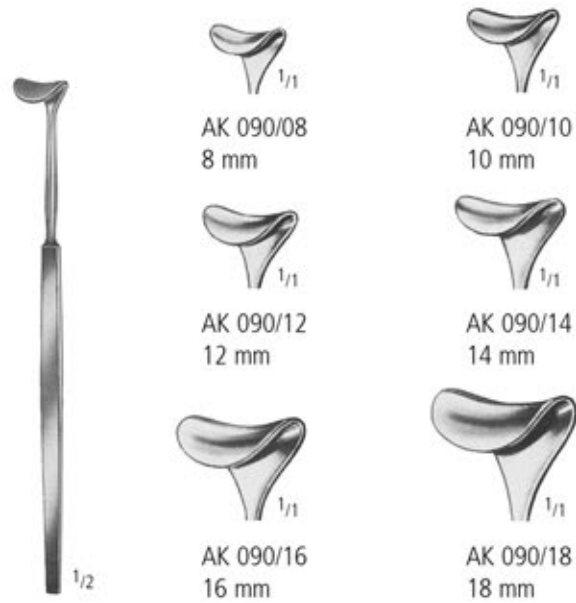

DESMARRES
13,0 cm/5"

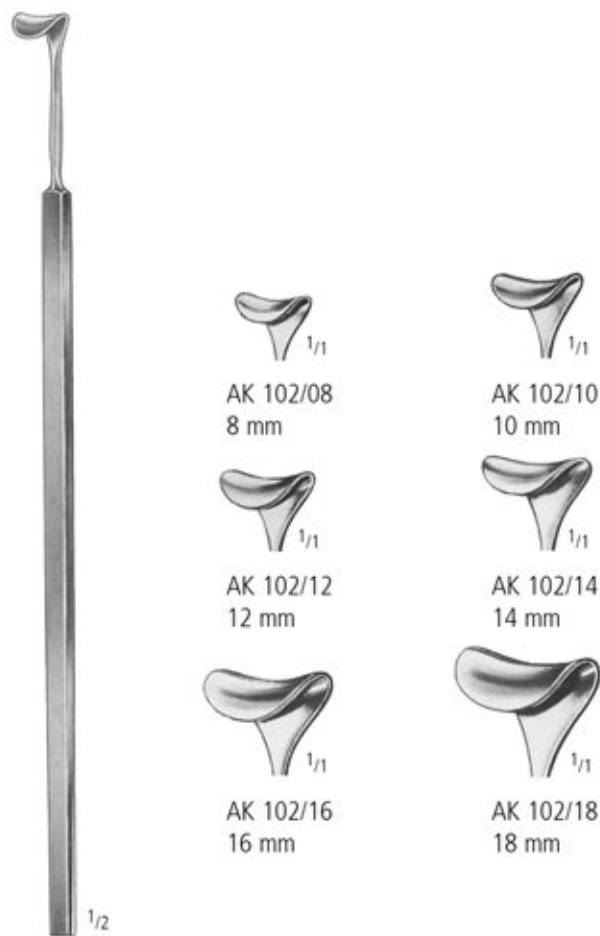

CUSHING
24,0 cm/9 1/2"

AA
AB
AC
AD
AE
AF
AK
AL
AO
AP
AR
KB
KI
KC
KU
KYE
X

Feine Wundhaken
Delicate Hooks
Ganchos
Crochets très fins
Divaricatori sottili

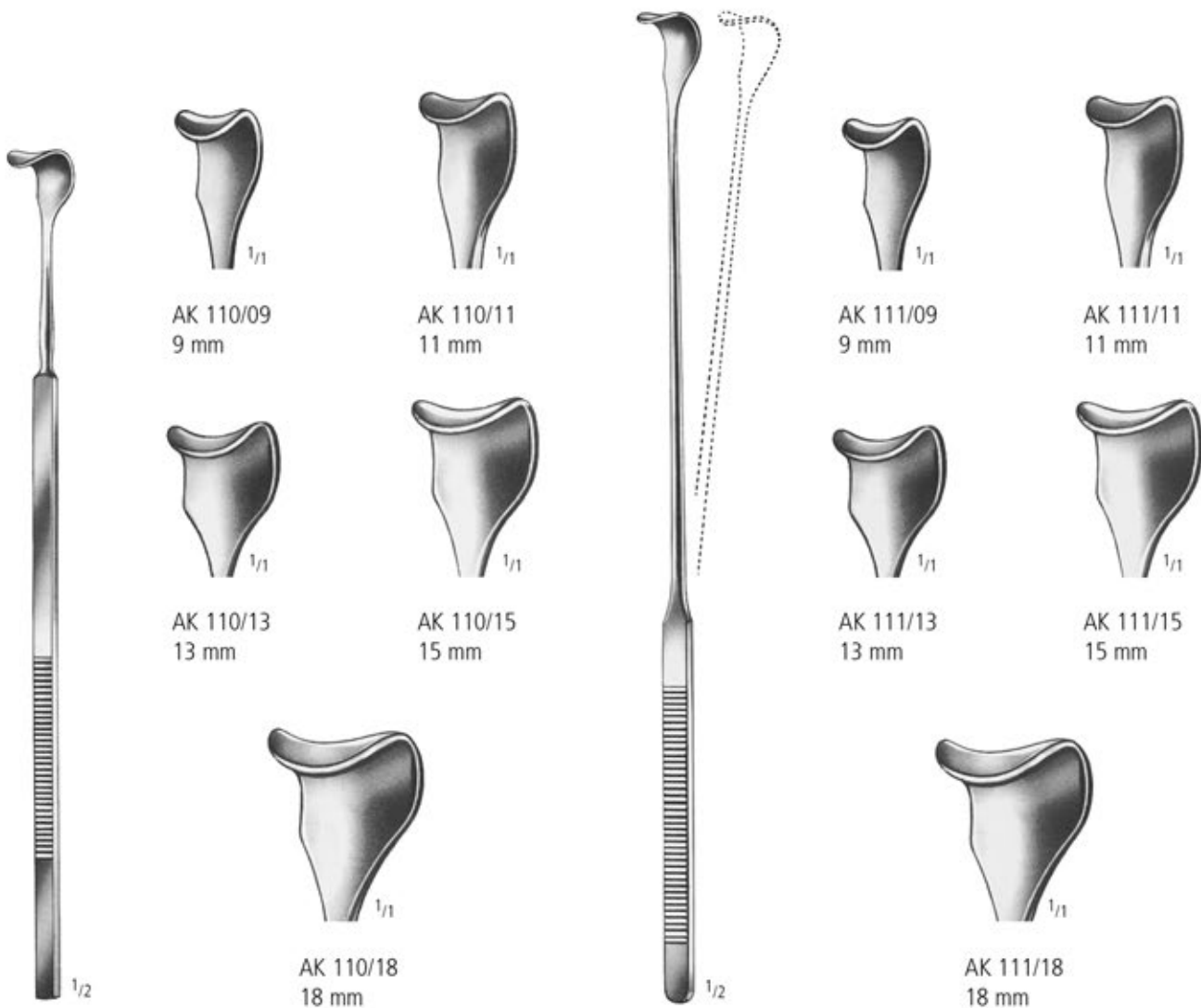

GIL-VERNET
24,5 cm/9³/₄"

GIL-VERNET
28,0 cm/11"

WUNDHAKEN RETRACTORS SEPARADORES ECARTEURS DIVARICATORI

AA
AB
AC
AD
AE
AF
AK
AL
AO
AP
AR
KB
KI
KC
KU
KYE
X



VOLKMANN
21,5 cm/8¹/₂"

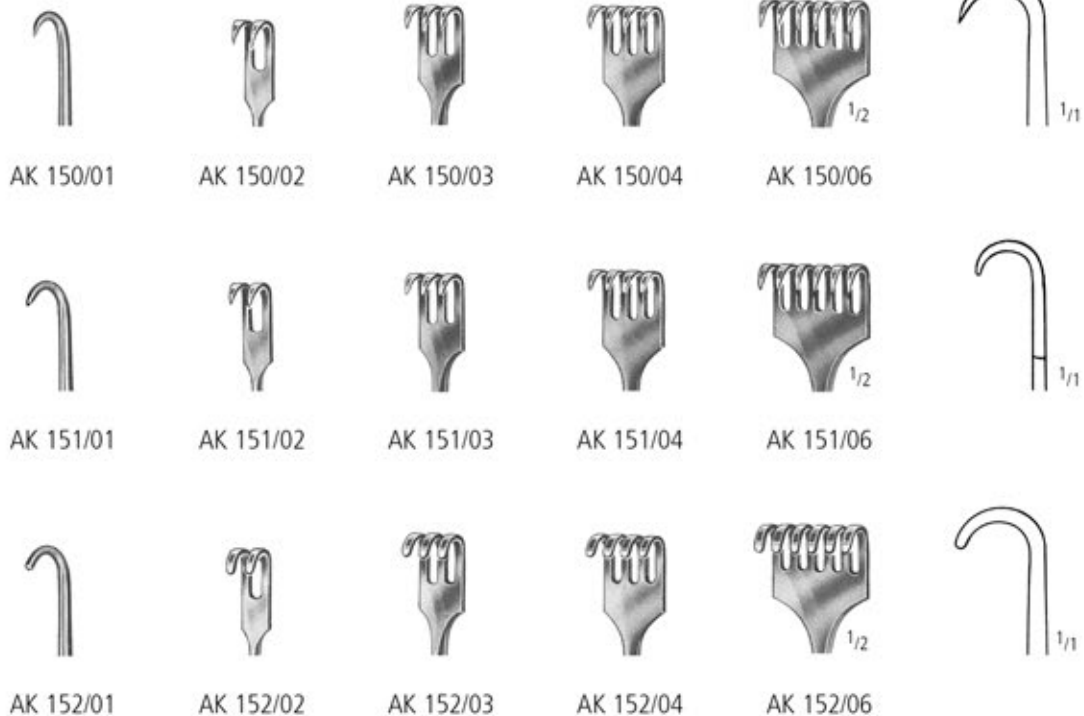

KOCHER
22,0 cm/8³/₄"

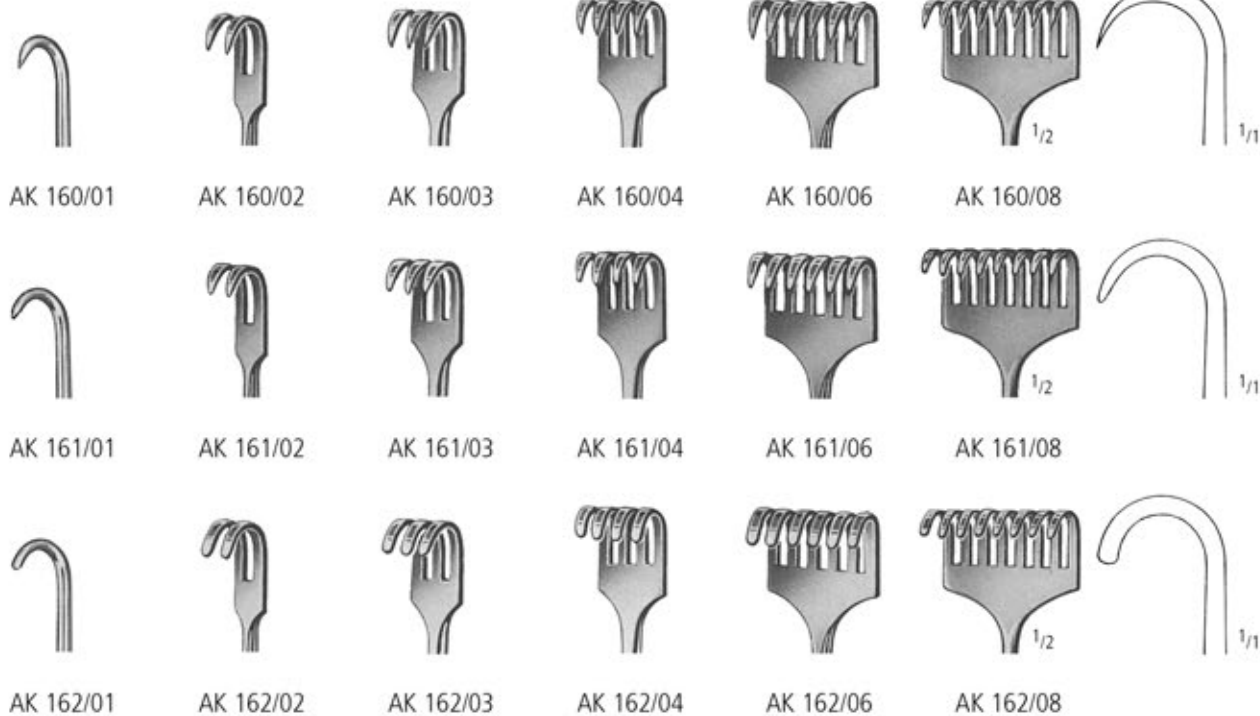

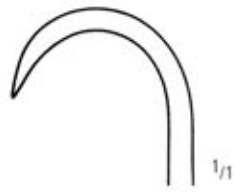

AK 170/21

VOLKMANN
21,5 cm/8 1/2"



AK 171/21



AK 172/20
20,0 cm/8"

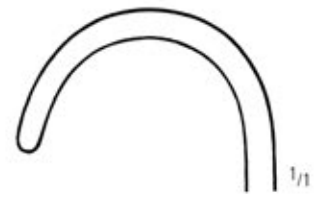

AK 173/20
20,0 cm/8"



AK 180/08
26 x 40 mm



AK 181/08
26 x 40 mm

KOERTE
24,0 cm/9 1/2"



AK 185/35
35 x 40 mm



AK 185/43
43 x 35 mm



AK 185/45
45 x 50 mm

BILLROTH
25,0 cm/10"



OLLIER
22,5 cm/9"

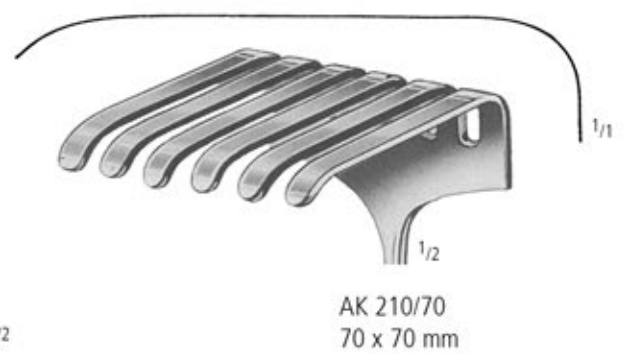
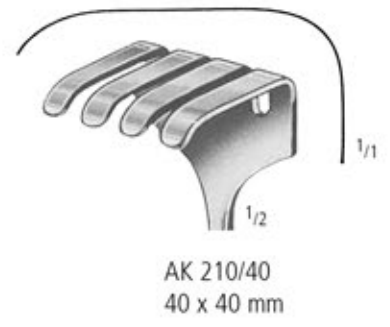

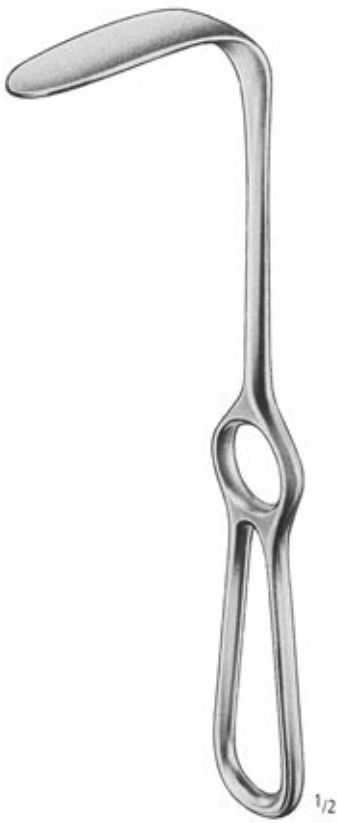

LANGENBECK
21,0 cm/8¹/₄"

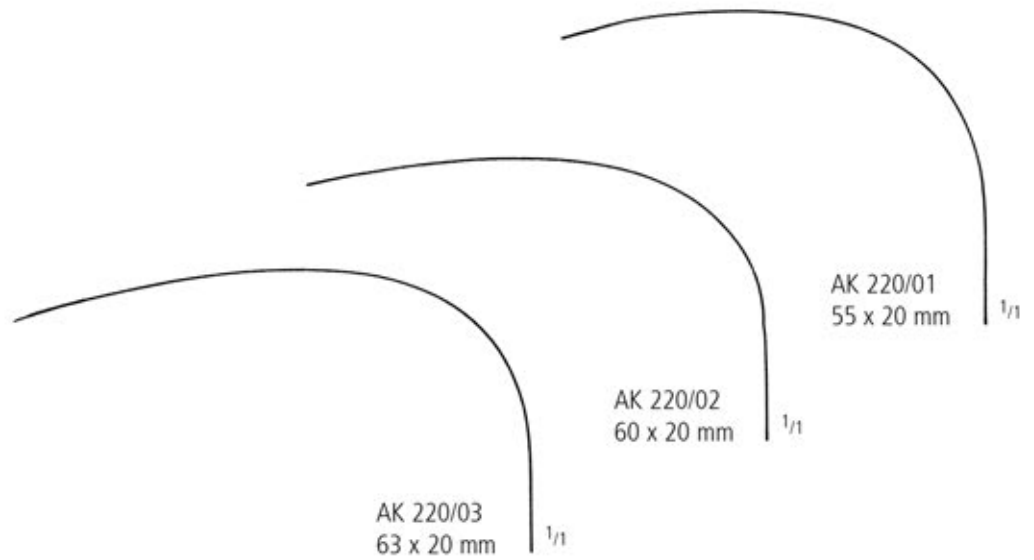

AK 220/01
55 x 20 mm ¹/₁

AK 220/02
60 x 20 mm ¹/₁

AK 220/03
63 x 20 mm ¹/₁



LANGENBECK
AK 230/01-05
22,0 cm/8³/₄"



AK 230/01
AK 231/01
30 x 11 mm



AK 230/02
AK 231/02
30 x 14 mm



AK 230/03
AK 231/03
30 x 16 mm



AK 230/04
AK 231/04
40 x 11 mm



AK 230/05
AK 231/05
50 x 11 mm



LANGENBECK
AK 231/01-05
22,0 cm/8³/₄"



AK 233/01
25 x 6 mm



AK 233/02
35 x 8 mm



AK 233/03
35 x 11 mm



AK 233/04
35 x 15 mm



AK 233/05
40 x 11 mm



AK 233/06
55 x 11 mm



AK 233/07
70 x 14 mm



AK 233/08
80 x 12 mm



AK 233/09
80 x 16 mm



KOCHER-LANGENBECK
21,5 cm/8½"

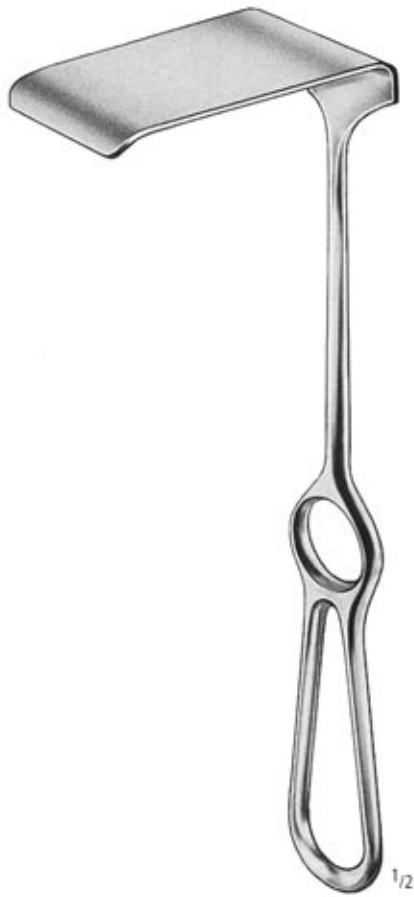

KOCHER
23,0 cm/9"

- AK 235/18
40 x 18 mm ^{1/11}
- AK 235/20
60 x 20 mm ^{1/11}
- AK 235/25
60 x 25 mm ^{1/11}
- AK 235/30
75 x 30 mm ^{1/11}
- AK 235/40
75 x 40 mm ^{1/11}

- AK 236/01
44 x 16 mm ^{1/11}
- AK 236/02
55 x 22 mm ^{1/11}
- AK 236/03
72 x 19 mm ^{1/11}

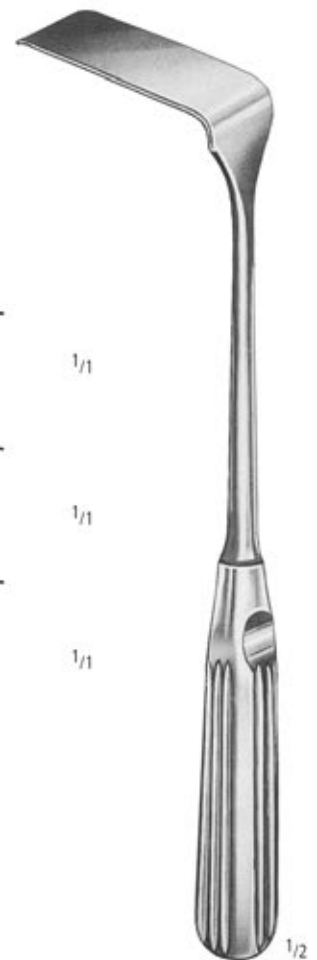

SAUERBRUCH
22,5 cm/8³/₄"



AK 237/01
50 x 55 mm

MORRIS
26,0 cm/10¹/₂"

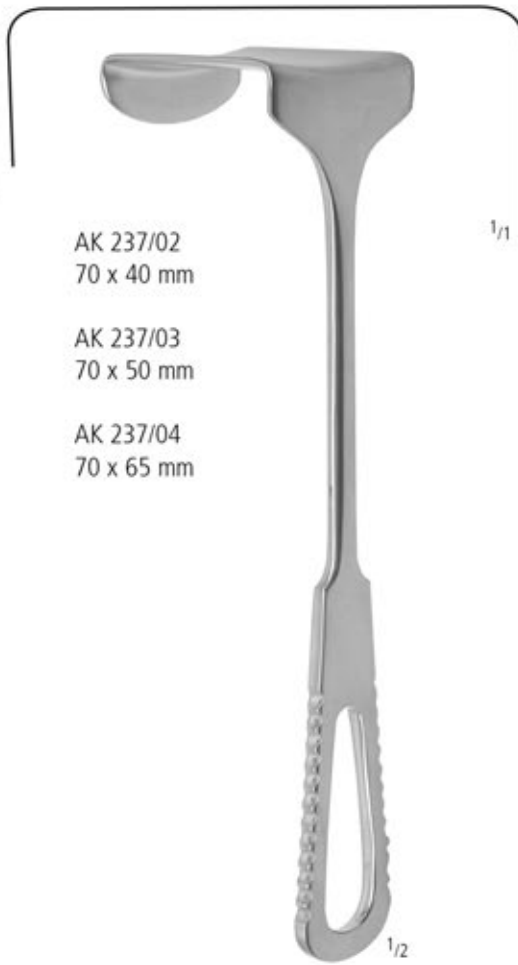

AK 237/02
70 x 40 mm

AK 237/03
70 x 50 mm

AK 237/04
70 x 65 mm

MORRIS
25 cm/10"



60 x 50 mm

60 x 45 mm

MORRIS
AK 238/24
25,0 cm/10"

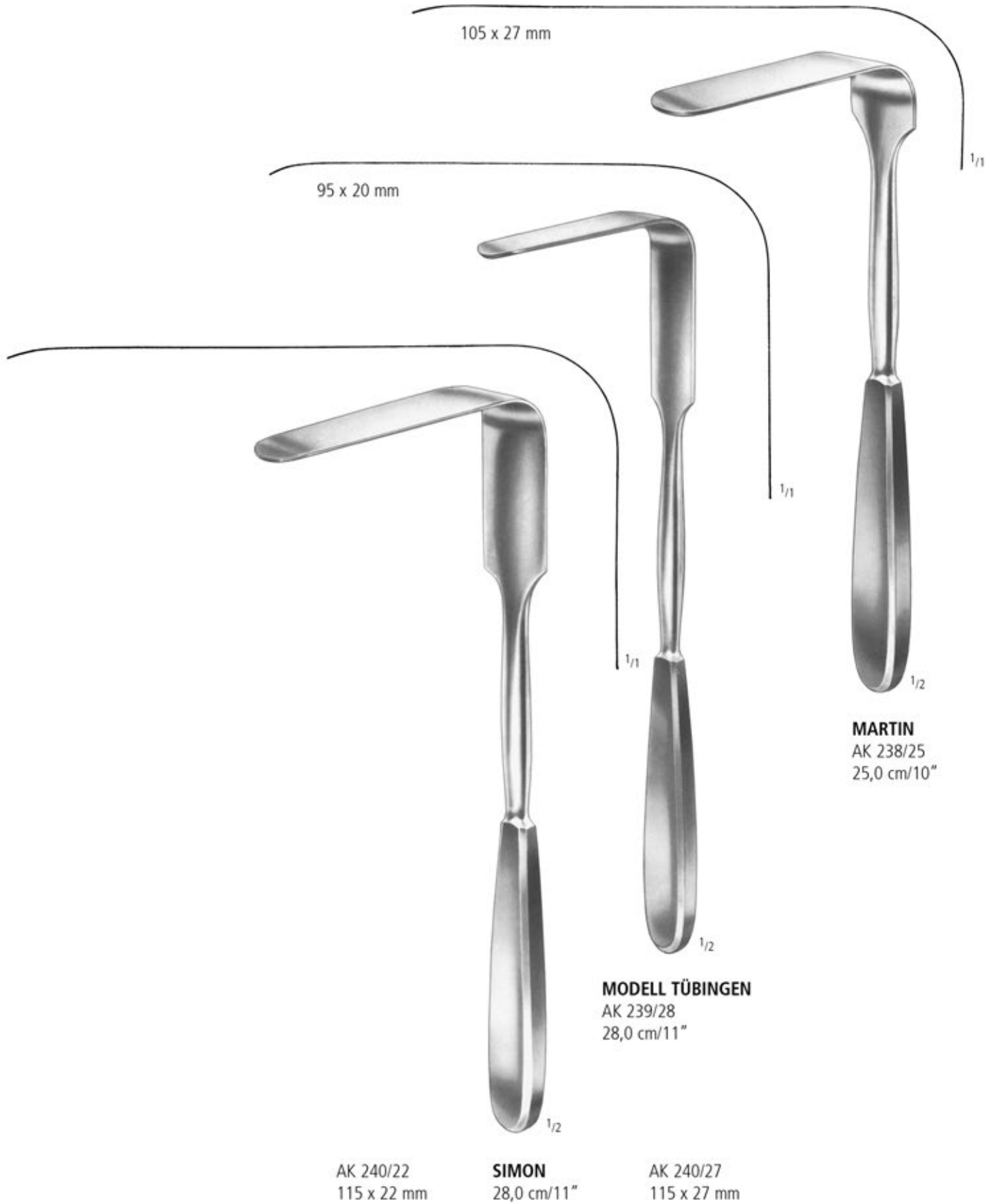

105 x 27 mm

95 x 20 mm

AK 240/22
115 x 22 mm

SIMON
AK 239/28
28,0 cm/11"

AK 240/27
115 x 27 mm

MARTIN
AK 238/25
25,0 cm/10"

MODELL TÜBINGEN
AK 239/28
28,0 cm/11"

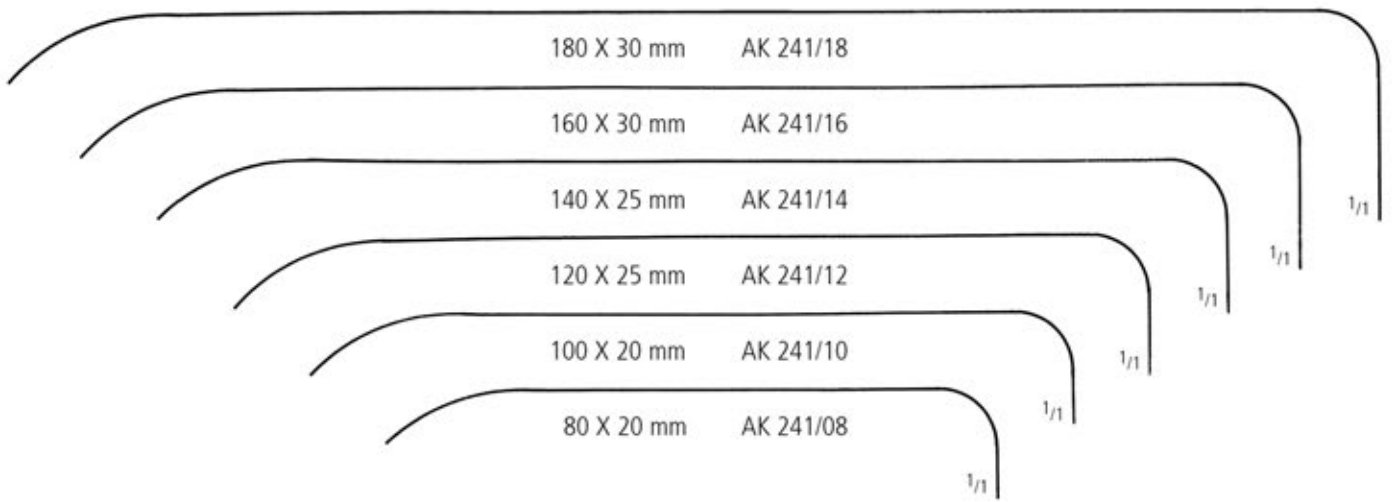

BRUNNER
AK 241/08-18
25,0 cm/10"



LAHEY
AK 242/19
19,0 cm/7 1/2"



LITTLE
AK 243/20
20,0 cm/8"

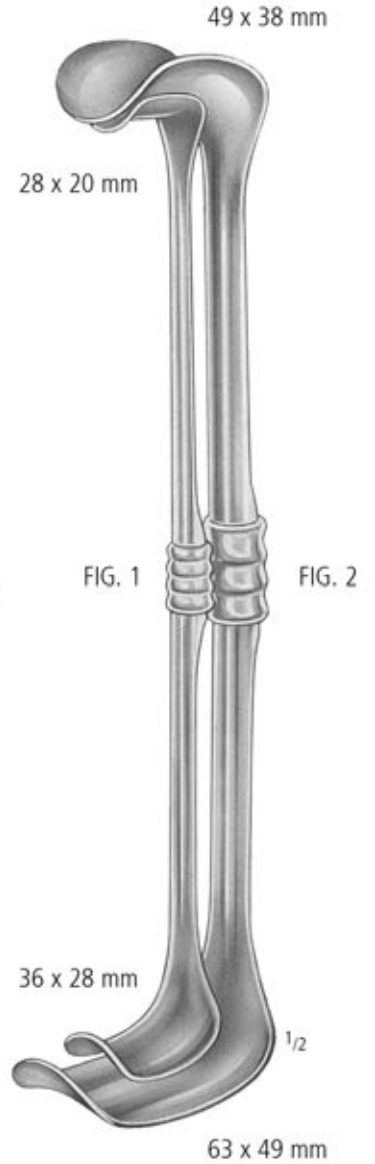
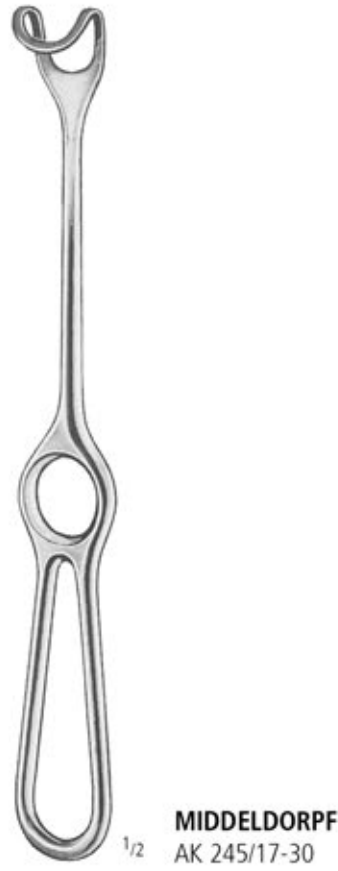
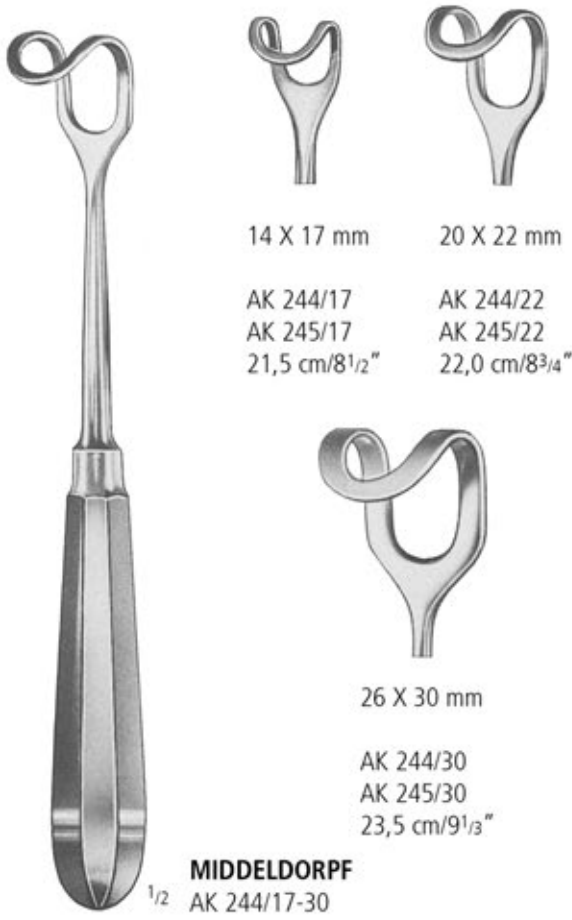

RICHARDSON-EASTMAN
FIG. 1+2 AK 248/00
FIG. 1 26,0 cm/10¹/₂" AK 248/01
FIG. 2 28,0 cm/11" AK 248/02

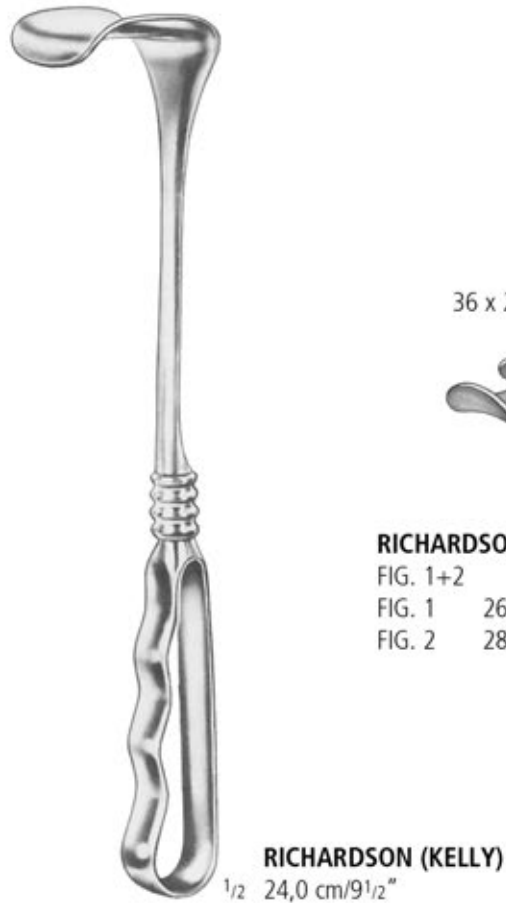



HOESEL
25,0 cm/10"



AK 250/01
60 x 20 mm



AK 250/02
80 x 30 mm

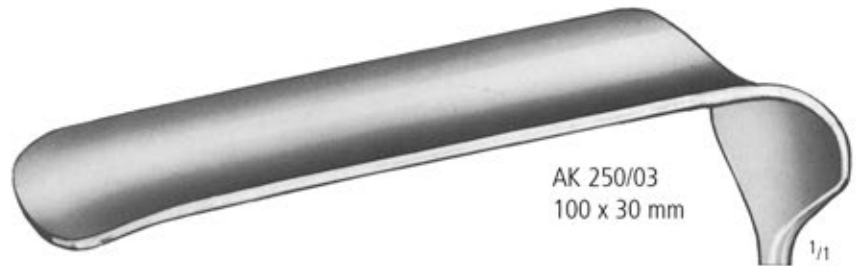

AK 250/03
100 x 30 mm



AK 250/04
120 x 30 mm



AK 250/05
140 x 30 mm



AK 250/06
140 x 40 mm

AA
AB
AC
AD
AE
AF
AK
AL
AO
AP
AR
KB
KI
KC
KU
KYE
X

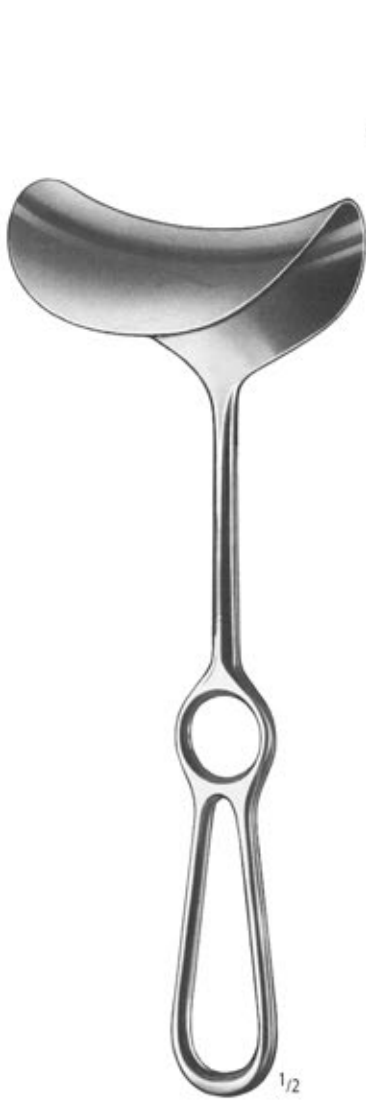

FRITSCH
24,0 cm / 9¹/₂"

45 x 40 mm	AK 254/40
45 x 50 mm	AK 254/50
45 x 60 mm	AK 254/60
45 x 75 mm	AK 254/75
65 x 85 mm	AK 254/85

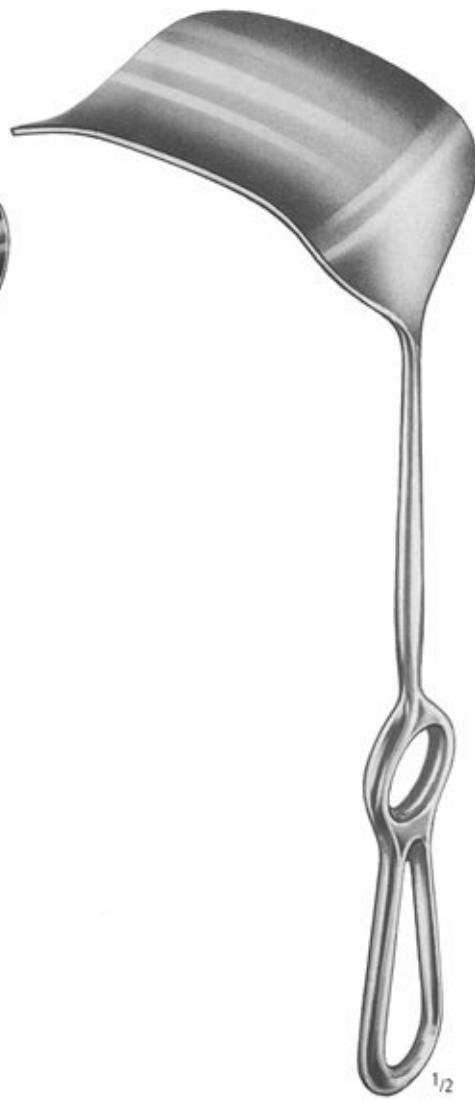

KOCHER

70 x 25 mm	22,0 cm / 8 ³ / ₄ "	AK 256/25
80 x 42 mm	25,0 cm / 10"	AK 256/42
80 x 50 mm	25,0 cm / 10"	AK 256/50
80 x 60 mm	25,0 cm / 10"	AK 256/60



DOYEN-STILLE
24,0 cm / 9¹/₂"

90 x 15 mm	AK 258/15
90 x 20 mm	AK 258/20
90 x 30 mm	AK 258/30
110 x 35 mm	AK 258/35
110 x 40 mm	AK 258/40
120 x 55 mm	AK 258/55



DEAVER
AK 300/01
18,0 cm/7"

DEAVER
AK 300/02
21,5 cm/8½"

DEAVER
AK 300/03
23,0 cm/9"

DEAVER
AK 300/04
30,0 cm/12"

DEAVER
AK 300/05
33,0 cm/13"

DEAVER
AK 300/06
36,0 cm/14"



38 mm

1/2

DEAVER
AK 300/07
30,0 cm/12"



50 mm

1/2

DEAVER
AK 300/08
30,0 cm/12"



75 mm

1/2

DEAVER
AK 300/09
30,0 cm/12"

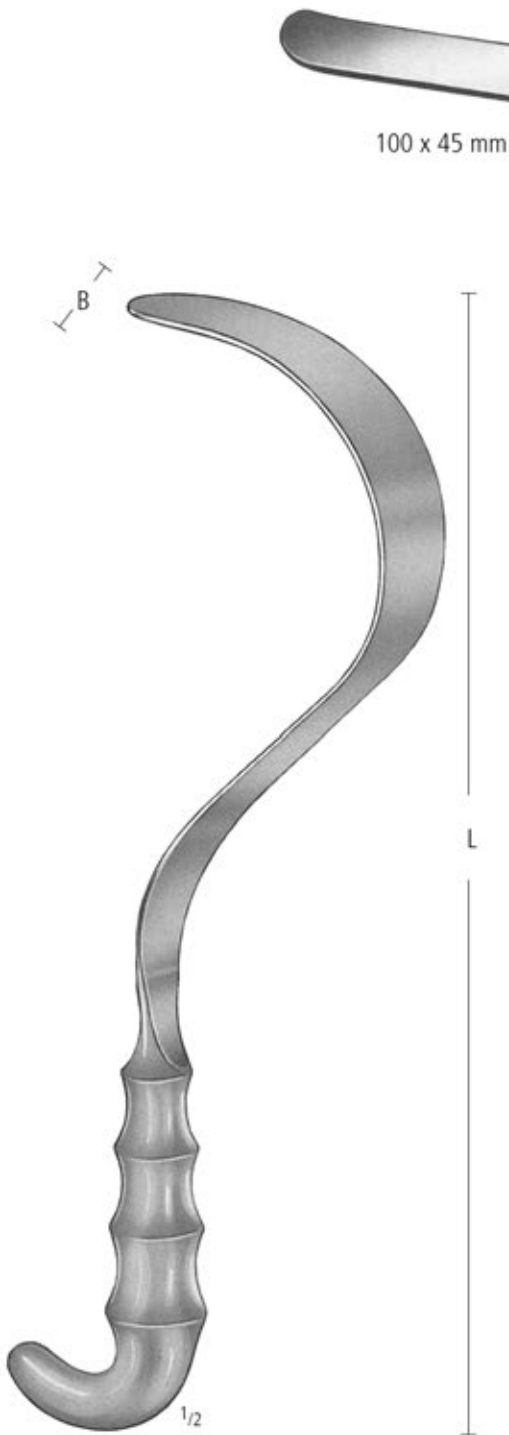

DEAVER
AK 310/01-05

	B	L	
Fig. 1	25 mm	30,5 cm/12"	AK 310/01
Fig. 2	25 mm	33,0 cm/13"	AK 310/02
Fig. 3	38 mm	30,5 cm/12"	AK 310/03
Fig. 4	50 mm	30,5 cm/12"	AK 310/04
Fig. 5	75 mm	30,5 cm/12"	AK 310/05

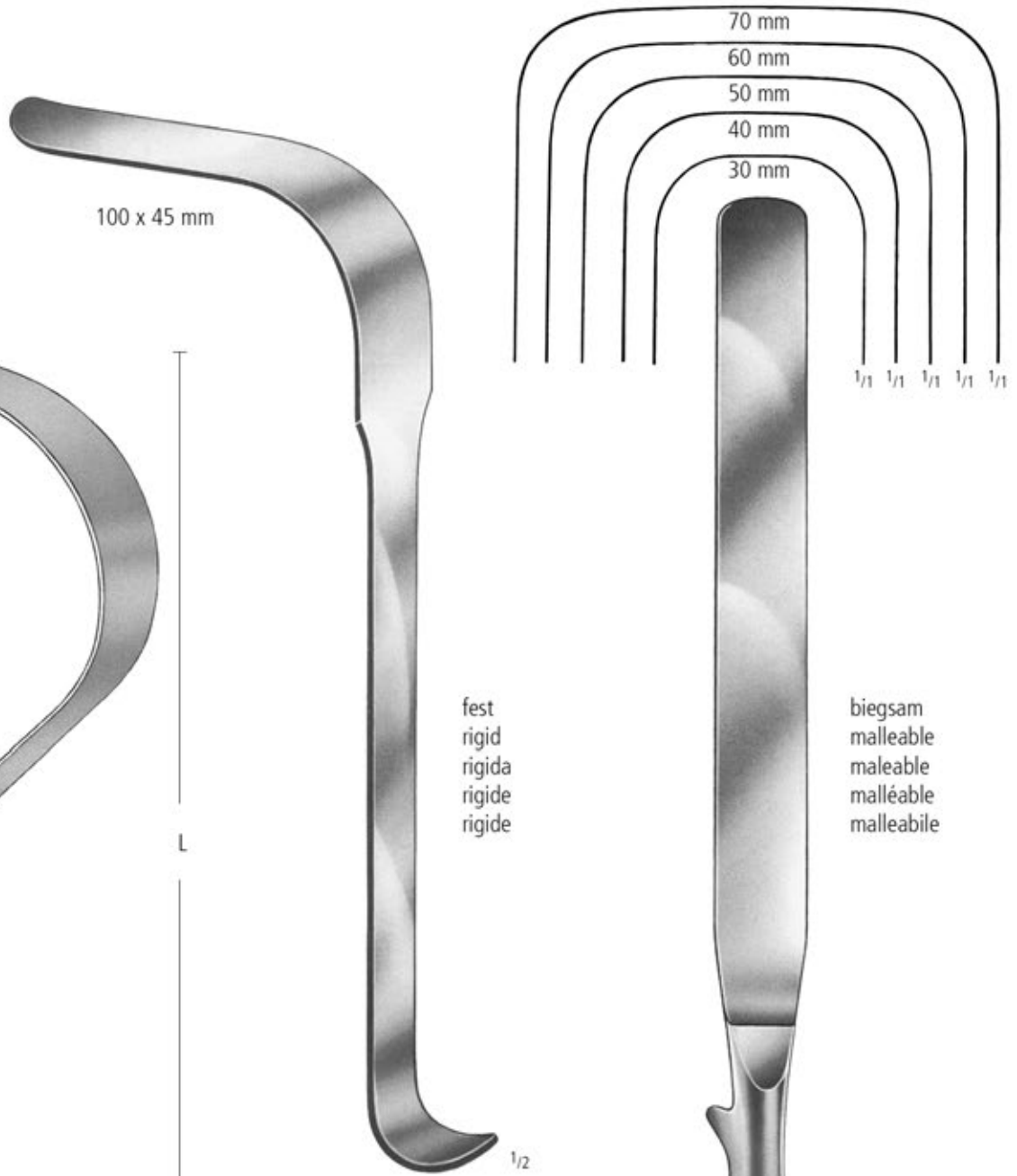

KOERTE
AK 312/28
28,0 cm / 11"

fest
rigid
rigida
rigide
rigide

biegsam
malleable
maleable
malléable
malleabile

41,0 cm / 16"	245 x 30 mm	AK 315/30
	245 x 40 mm	AK 315/40
	245 x 50 mm	AK 315/50
	245 x 60 mm	AK 315/60
	245 x 70 mm	AK 315/70



AK 328/22
82 x 22 mm



AK 328/38
115 x 38 mm



AK 328/65
115 x 65 mm



130 x 38 mm

CORYLLOS
24,0 cm/9 1/2"

SAUERBRUCH
AK 330/25
25,0 cm/10"



1/2

HEANEY

27,0 cm/10³/₄"

- | | |
|------------|-----------|
| 45 x 25 mm | AK 340/01 |
| 73 x 28 mm | AK 340/02 |
| 82 x 28 mm | AK 340/03 |

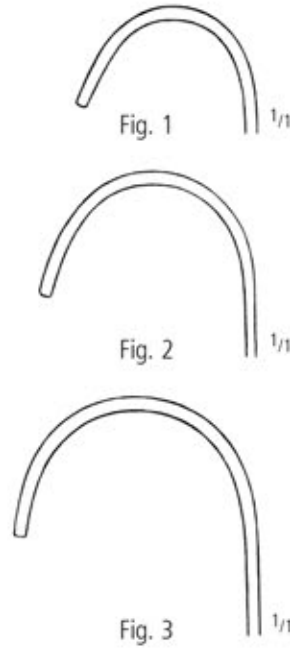

Fig. 1

1/1

Fig. 2

1/1

Fig. 3

1/1



1/2

ROUX

16,5 cm/6¹/₂"

- | | |
|------------|-----------|
| Fig. 1+2+3 | AK 350/00 |
| Fig. 1 | AK 350/01 |
| Fig. 2 | AK 350/02 |
| Fig. 3 | AK 350/03 |



COLLIN-HARTMANN

- | | |
|---|-----------|
| 14,0 cm/5 ¹ / ₂ " | AK 351/14 |
| 16,0 cm/6 ¹ / ₄ " | AK 351/16 |



38 x 28 mm

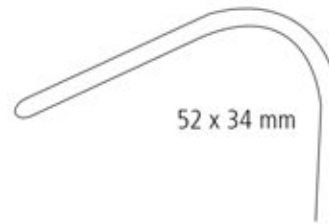

52 x 34 mm



32 x 21 mm

1/1

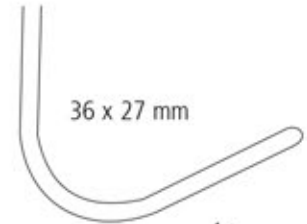

36 x 27 mm

1/1

Fig. 1 AK 352/01
Fig. 2 AK 352/02



FARABEU
AK 352/00 Fig. 1+2
12,0 cm/4³/₄"

Fig. 1 AK 354/01
Fig. 2 AK 354/02



FARABEU
AK 354/00 Fig. 1+2
15,0 cm/6"

AK 373/01
Fig. 1

AK 373/02
Fig. 2



PARKER
AK 373/00 Fig. 1+2
13,5 cm/5¹/₄"

AK 374/01
Fig. 1

AK 374/02
Fig. 2

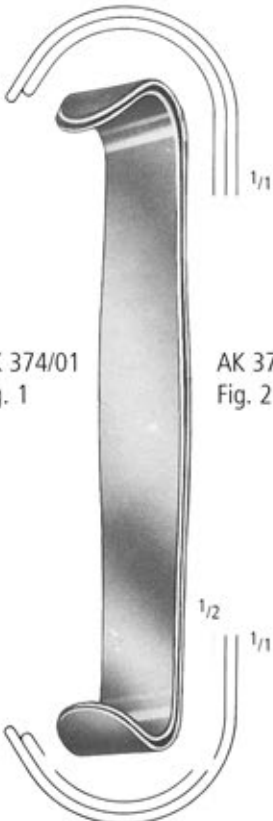

PARKER
AK 374/00 Fig. 1+2
18,0 cm/7"

AK 380/01
Fig. 1

AK 380/02
Fig. 2



MATHIEU
AK 380/00 Fig. 1+2
20,0 cm/8"

AK 384/01
Fig. 1

AK 384/02
Fig. 2

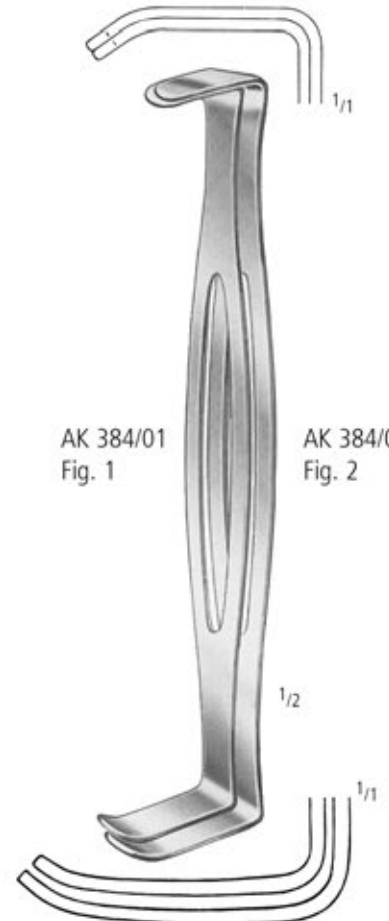

PARKER-LANGENBECK (U.S. Army)
AK 384/00 Fig. 1+2
21,0 cm/8¹/₄"

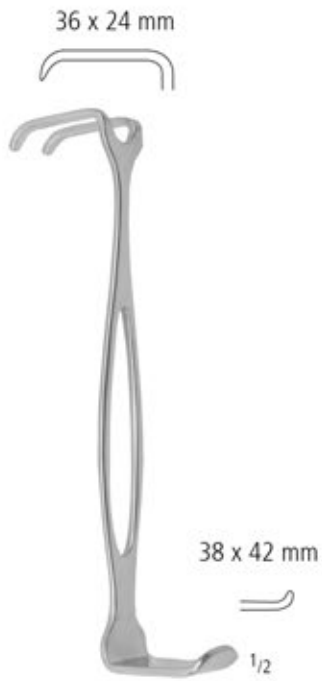

CZERNY
AK 386/17
17,5 cm/7"



GOELET
AK 390/19
19,0 cm/7 1/2"

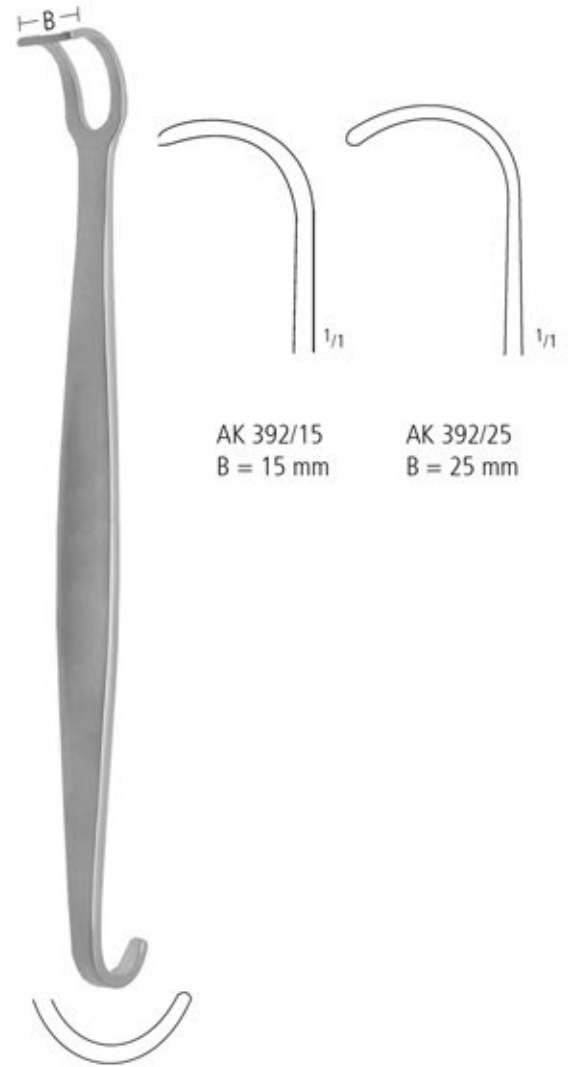

AK 392/15
B = 15 mm

AK 392/25
B = 25 mm

AK WUNDHAKEN RETRACTORS SEPARADORES ECARTEURS DIVARICATORI

Selbsthaltende Wundsperrer
 Selfretaining Retractors
 Separadores autoestaticos
 Ecarteurs autostatiques
 Divaricatori autostatici

komplett
 complete
 completo
 complet
 completo

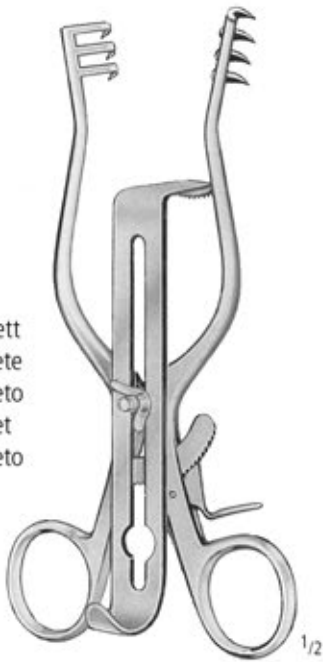

HENLEY

AK 536/00 AK 537/00
 16,5 cm/6 1/2"



19 mm x 16 mm
 AK 536/19

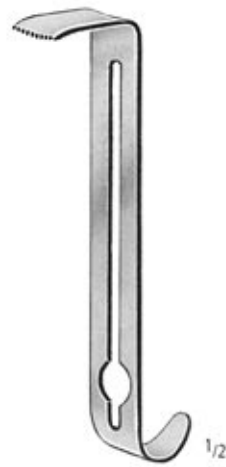

25 mm x 16 mm
 AK 536/25



32 mm x 16 mm
 AK 536/32



MILLIGAN

AK 538/13 AK 539/13
 13,0 cm/5"



TRAVERS

AK 540/21
 21,0 cm/8 1/4"

WUNDHAKEN RETRACTORS SEPARADORES ECARTEURS DIVARICATORI

Selbsthaltende Wundsperrer
Selfretaining Retractors
Separadores autoestaticos
Ecarteurs autostatiques
Divaricatori autostatici



SCHUHKNECHT
 ^ ^
 AK 542/14 AK 543/14
 14,0 cm/5 1/2"



WULLSTEIN
 ^ ^
 10,5 cm/4 1/4" AK 544/10 AK 545/10
 13,0 cm/5" AK 544/13 AK 545/13
 16,0 cm/6 1/4" AK 544/16 AK 545/16



MOLLISON
 ^ ^
 AK 550/15 AK 551/15
 15,0 cm/6"



MISKIMON
 ^ ^
 AK 552/22 AK 553/22
 22,0 cm/8 3/4"

AA
AB
AC
AD
AE
AF
AK
AL
AO
AP
AR
KB
KI
KC
KU
KYE
X

Selbsthaltende Wundsperrer
 Selfretaining Retractors
 Separadores autoestaticos
 Ecarteurs autostatiques
 Divaricatori autostatici



ADSON

AK 554/20 AK 555/20
 20,0 cm/8"



ANDERSON-ADSON

AK 556/20 AK 557/20
 20,0 cm/8"

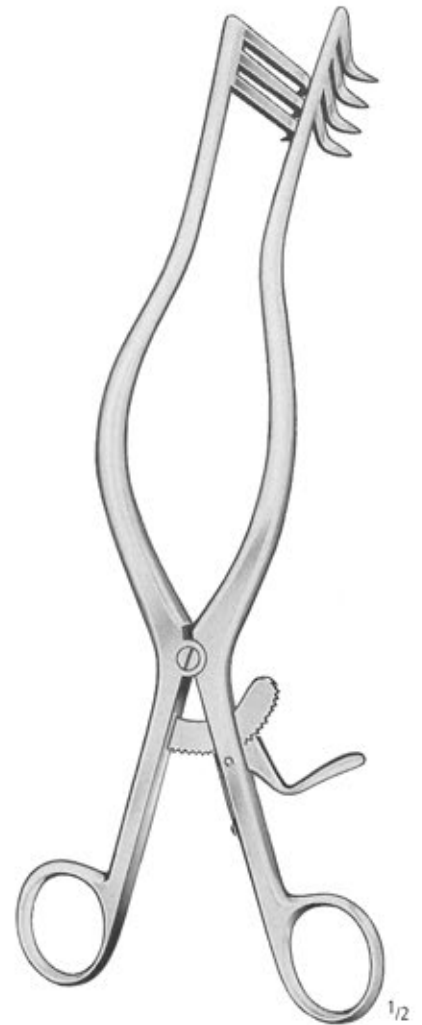

ADSON

AK 558/27 AK 559/27
 27,0 cm/10³/₄"

WUNDHAKEN RETRACTORS SEPARADORES ECARTEURS DIVARICATORI

Selbsthaltende Wundsperrer
Selfretaining Retractors
Separadores autoestaticos
Ecarteurs autostatiques
Divaricatori autostatici



ADSON
AK 560/27
27,0 cm/10³/₄"



ADSON-R
AK 561/01
27,0 cm/10³/₄"



ADSON-L
AK 561/02
27,0 cm/10³/₄"

AA
AB
AC
AD
AE
AF
AK
AL
AO
AP
AR
KB
KI
KC
KU
KYE
X

AK WUNDHAKEN RETRACTORS SEPARADORES ECARTEURS DIVARICATORI

Selbsthaltende Wundsperrer
Selfretaining Retractors
Separadores autoestaticos
Ecarteurs autostatiques
Divaricatori autostatici



ADSON-BABY
AK 562/14
14,0 cm/5¹/₂"



CONE

13,0 cm/5"
16,5 cm/6¹/₂"
20,0 cm/8"
25,0 cm/10"

3 x 4
3 x 4
3 x 4
3 x 4

^
AK 564/13
AK 564/16
AK 564/20
AK 564/25

∩
AK 565/13
AK 565/16
AK 565/20
AK 565/25

31,0 cm/12¹/₄"
33,0 cm/13"

4 x 4
4 x 5

^
AK 566/31
AK 568/33

∩
AK 567/31
AK 569/33

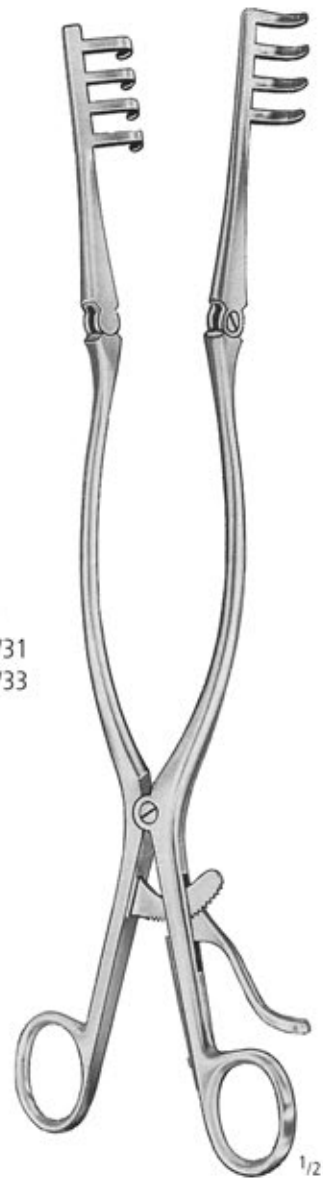

BECKMANN

WUNDHAKEN RETRACTORS SEPARADORES ECARTEURS DIVARICATORI

Selbsthaltende Wundsperrer
Selfretaining Retractors
Separadores autoestaticos
Ecarteurs autostatiques
Divaricatori autostatici



25 x 25 mm
25 x 31 mm
25 x 40 mm
25 x 45 mm

^
AK 570/01
AK 570/02
AK 570/03
AK 570/04

∩
AK 571/01
AK 571/02
AK 571/03
AK 571/04

BECKMANN-ADSON
31,0 cm/12¹/₄"



BECKMANN-EATON
^ ∩
AK 572/33 AK 573/33
33,0 cm/13"

AA
AB
AC
AD
AE
AF
AK
AL
AO
AP
AR
KB
KI
KC
KU
KYE
X

Selbsthaltende Wundsperrer
Selfretaining Retractors
Separadores autoestaticos
Ecarteurs autostatiques
Divaricatori autostatici



SCALP-CONTOUR

AK 574/14 AK 575/14
14,0 cm/5 1/2"



GELPI

9,0 cm/3 1/2" AK 580/09
11,0 cm/4 1/3" AK 580/11
14,0 cm/5 1/2" AK 580/14
19,0 cm/7 1/2" AK 580/19



GELPI

AK 581/19
19,0 cm/7 1/2"



MEYERDING

20,0 cm/8"
32 x 25 mm AK 582/01
54 x 25 mm AK 582/02
60 x 19 mm AK 582/03
60 x 25 mm AK 582/04

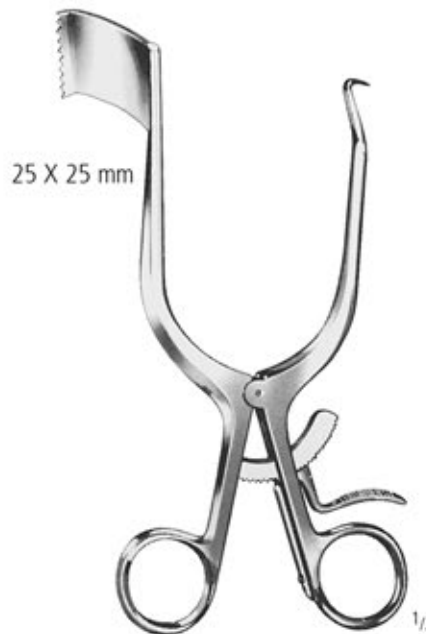

MARKHAM-MEYERDING

AK 583/01
18,0 cm/7"



MARKHAM-MEYERDING

AK 583/02
18,0 cm/7"

WUNDHAKEN RETRACTORS SEPARADORES ECARTEURS DIVARICATORI

Selbsthaltende Wundsperrer
Selfretaining Retractors
Separadores autoestaticos
Ecarteurs autostatiques
Divaricatori autostatici

AA
AB
AC
AD
AE
AF
AK
AL
AO
AP
AR
KB
KI
KC
KU
KYE
X



RIGHTBY
18,0 cm/7"

35 x 20 mm AK 586/01
60 x 20 mm AK 586/02
65 x 15 mm AK 586/03



DARLING

AK 587/01
18,0 cm/7"



DARLING

AK 587/02
18,0 cm/7"



PLESTER

AK 590/10 AK 590/13
10,0 cm/4" 13,0 cm/5"



PLESTER-R

AK 591/10 AK 591/13
10,0 cm/4" 13,0 cm/5"



PLESTER-L

AK 592/10 AK 592/13
10,0 cm/4" 13,0 cm/5"

Selbsthaltende Wundsperrer
 Selfretaining Retractors
 Separadores autoestaticos
 Ecarteurs autostatiques
 Divaricatori autostatici



TÜBINGER MODELL

AK 594/16
 16,5 cm/6¹/₂"

AK 594/18
 18,0 cm/7"



MAYO-ADAMS

AK 596/17
 17,0 cm/6³/₄"

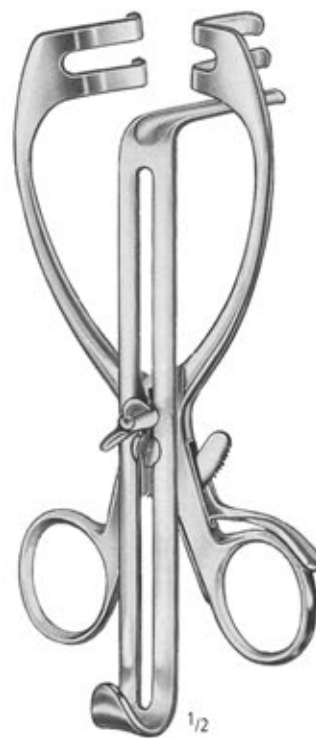

MAYO-ADAMS

AK 598/17
 17,0 cm/6³/₄"

WUNDHAKEN RETRACTORS SEPARADORES ECARTEURS DIVARICATORI

Selbsthaltende Wundsperrer
Selfretaining Retractors
Separadores autoestaticos
Ecarteurs autostatiques
Divaricatori autostatici



WALTON

AK 599/01
18,0 cm/7"



WALTON

AK 599/02
18,0 cm/7"



KNIGHTON

AK 600/01
18,0 cm/7"



KNIGHTON

AK 600/02
18,0 cm/7"

AA
AB
AC
AD
AE
AF
AK
AL
AO
AP
AR
KB
KI
KC
KU
KYE
X

Bauchdeckenhalter
 Abdominal Retractors
 Separadores abdominales
 Ecarteurs abdominaux
 Divaricatori addominali

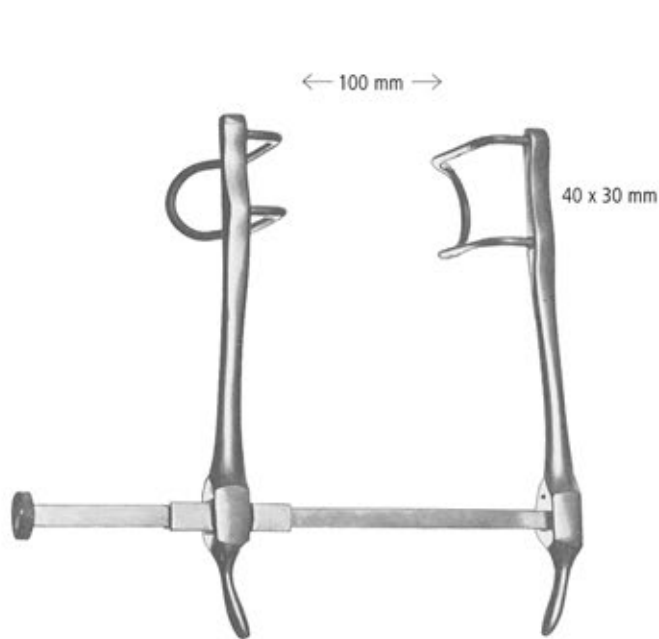

GOSSET
AK 610/10

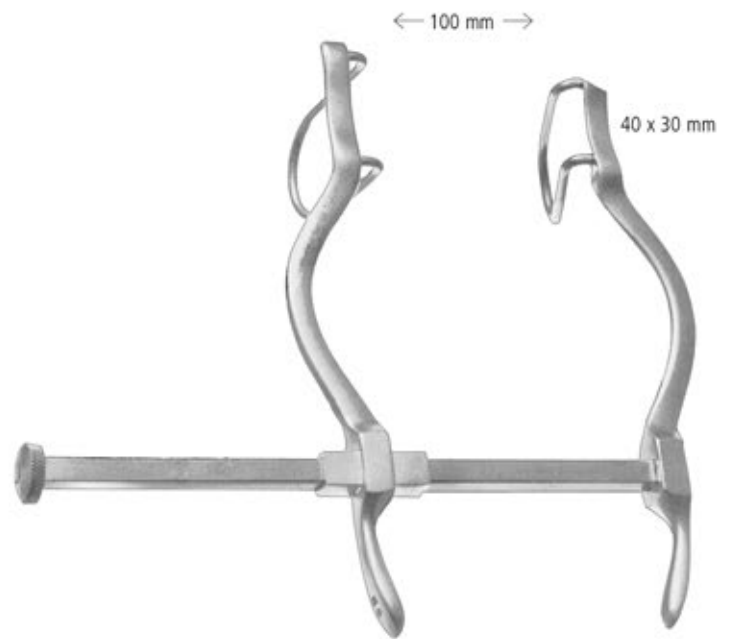

GOSSET
AK 611/10

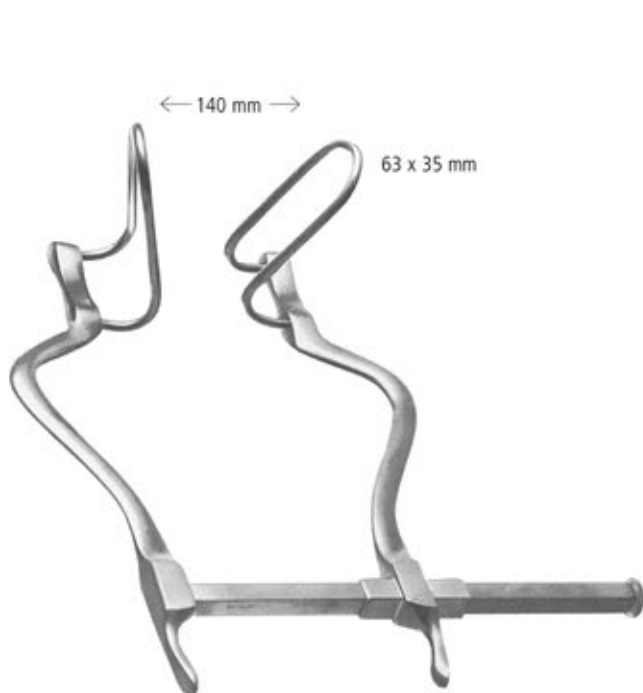

GOSSET
AK 612/14

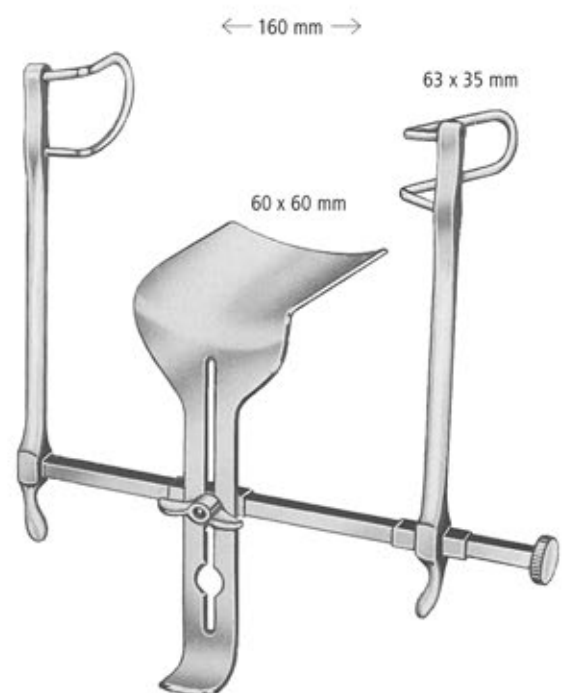

GOSSET
AK 613/16

WUNDHAKEN RETRACTORS SEPARADORES ECARTEURS DIVARICATORI

Bauchdeckenhalter
Abdominal Retractors
Separadores abdominales
Ecarteurs abdominaux
Divaricatori addominali

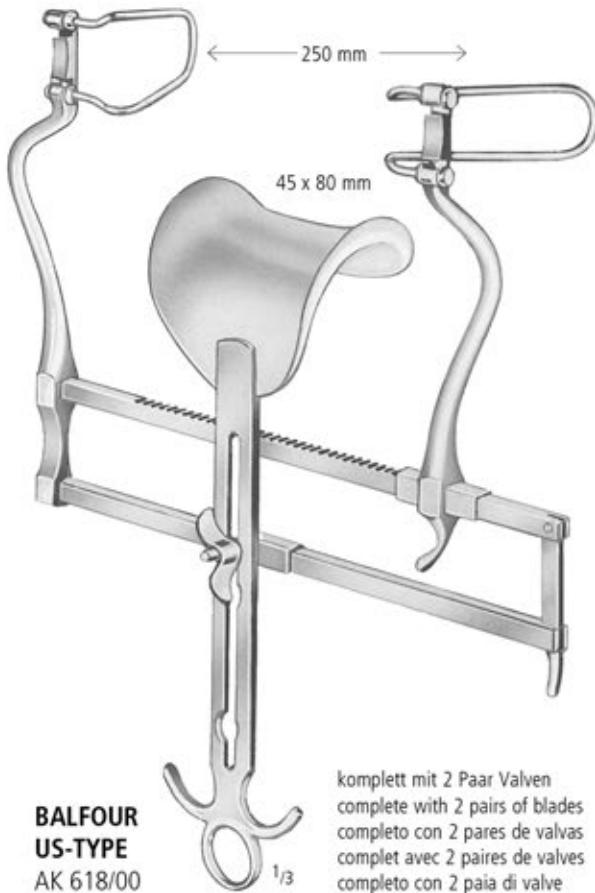

**BALFOUR
US-TYPE**
AK 618/00

komplett mit 2 Paar Valven
complete with 2 pairs of blades
completo con 2 pares de valvas
complet avec 2 paires de valves
completo con 2 paia di valve

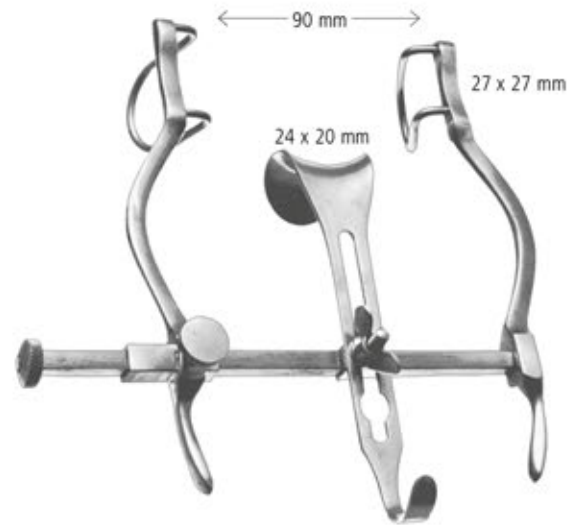

BALFOUR BABY
AK 620/09

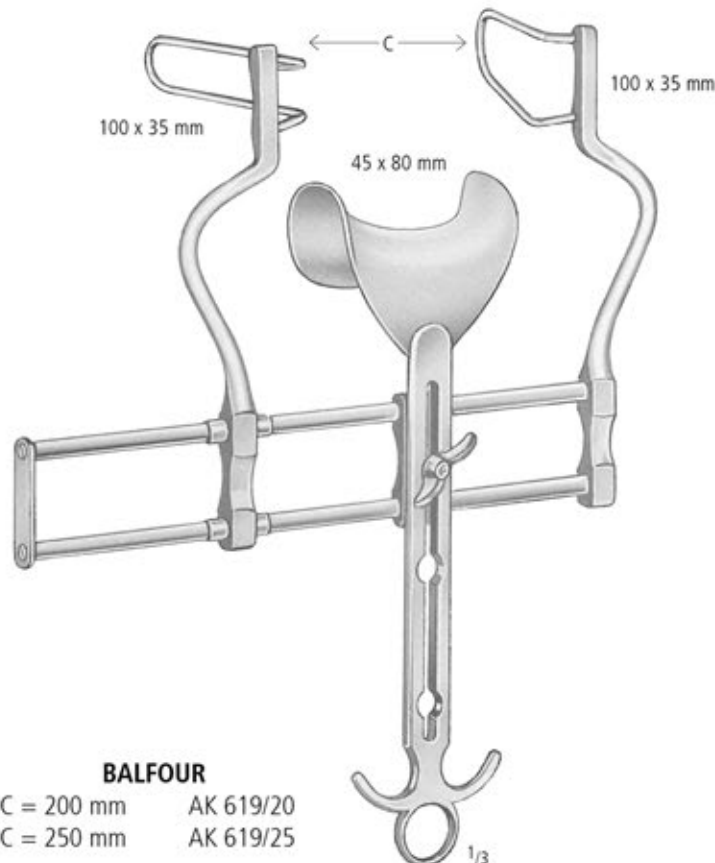

BALFOUR

C = 200 mm AK 619/20
C = 250 mm AK 619/25

AA
AB
AC
AD
AE
AF
AK
AL
AO
AP
AR
KB
KI
KC
KU
KYE
X

Bauchdeckenhalter
 Abdominal Retractors
 Separadores abdominales
 Ecarteurs abdominaux
 Divaricatori addominali

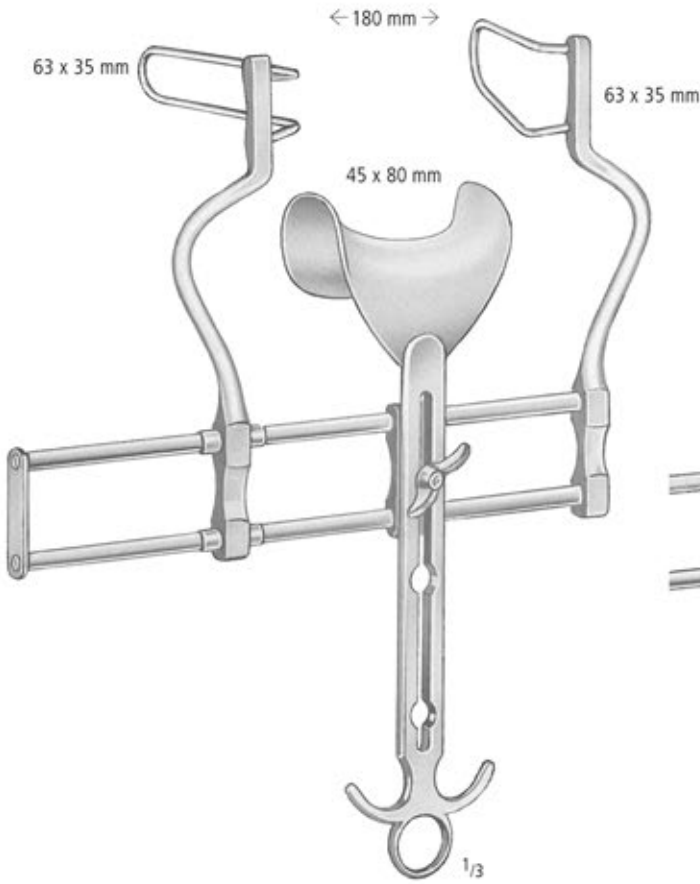

BALFOUR
 AK 620/18

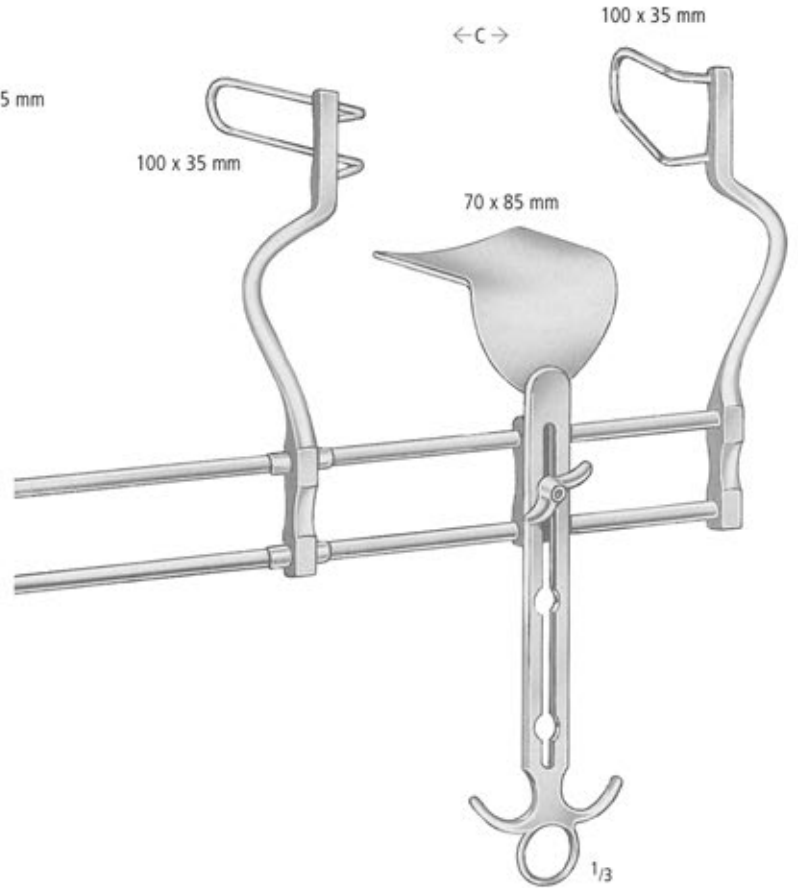

BALFOUR
 C = 200 mm AK 620/20
 C = 250 mm AK 620/25



AK 62
 100 x

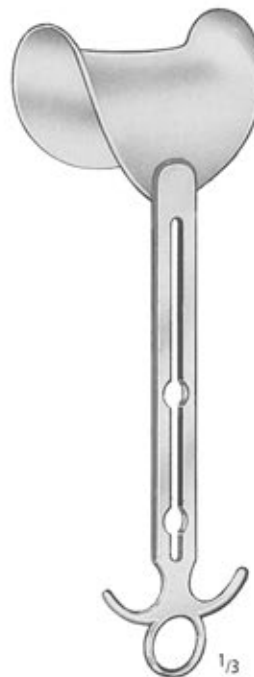

BALFOUR
 45 x 80 mm AK 622/01
 70 x 85 mm AK 622/02

WUNDHAKEN RETRACTORS SEPARADORES ECARTEURS DIVARICATORI

Bauchdeckenhalter
Abdominal Retractors
Separadores abdominales
Ecarteurs abdominaux
Divaricatori addominali

AK 700/23
23 x 44 mm



AK 700/30
30 x 44 mm



komplett
complete
completo
complet
completo

COLLIN-BABY

AK 700/00
18,0 cm/7"

← 165 mm →

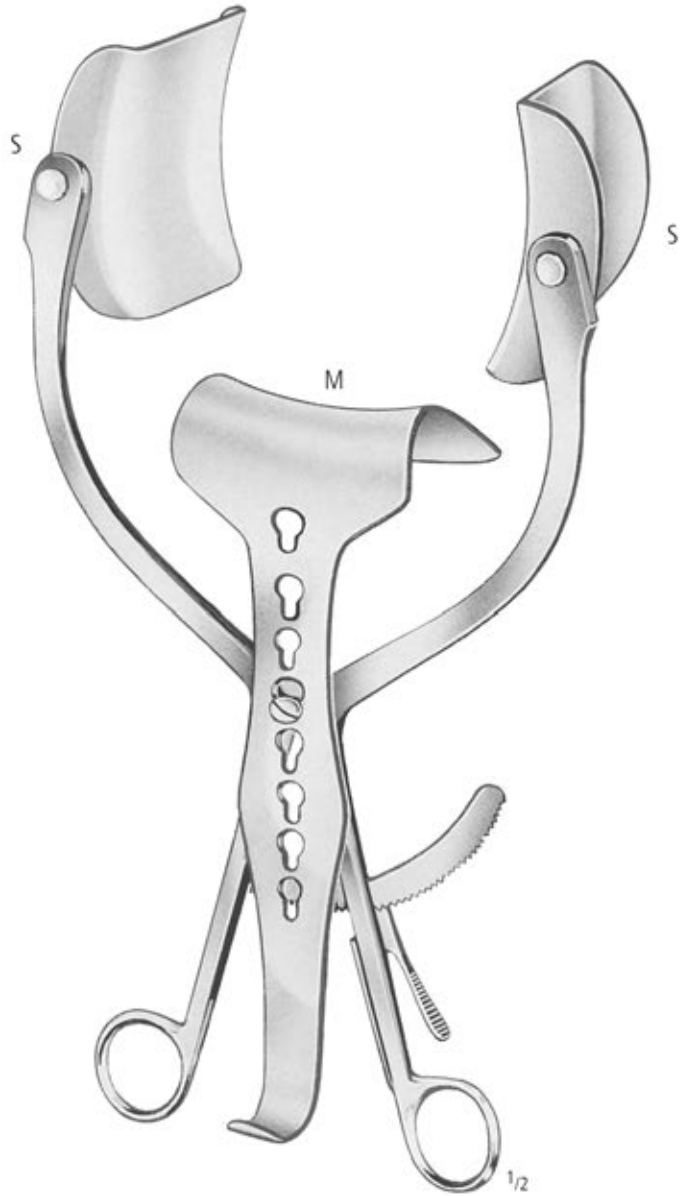

COLLIN

	S	M
AK 702/16	50 x 58 mm	62 x 67 mm
AK 704/16	62 x 80 mm	62 x 67 mm

AA
AB
AC
AD
AE
AF
AK
AL
AO
AP
AR
KB
KI
KC
KU
KYE
X

Bauchdeckenhalter
 Abdominal Retractors
 Separadores abdominales
 Ecarteurs abdominaux
 Divaricatori addominali



COLLIN

AK 706/10
 22,0 cm/8³/₄"

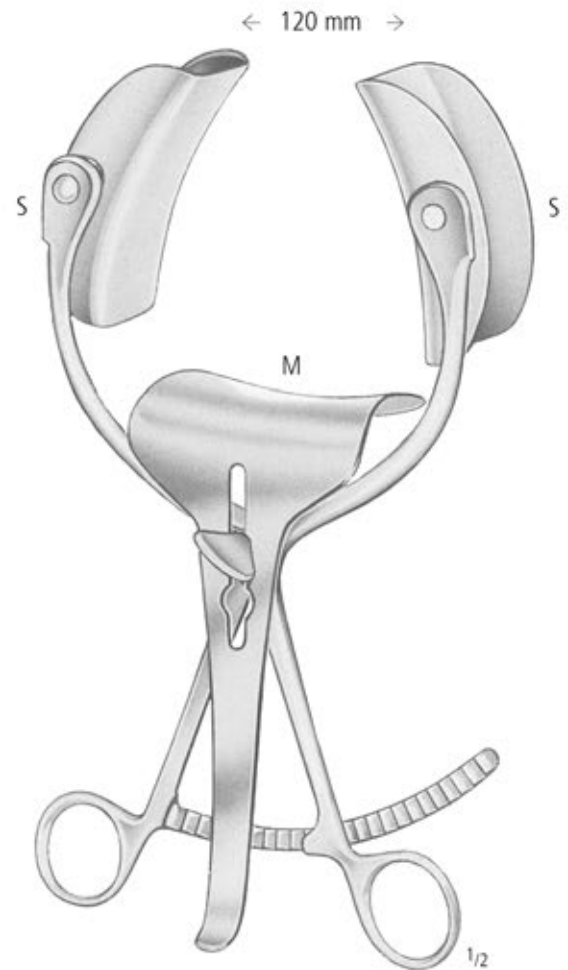

COLLIN

	S	M
AK 708/12	38 x 62 mm	55 x 55 mm
AK 709/12	38 x 80 mm	55 x 65 mm
AK 710/12	38 x 100 mm	55 x 75 mm

WUNDHAKEN RETRACTORS SEPARADORES ECARTEURS DIVARICATORI

Bauchdeckenhalter
 Abdominal Retractors
 Separadores abdominales
 Ecarteurs abdominaux
 Divaricatori addominali

AA

AB

AC

AD

AE

AF

AK

AL

AO

AP

AR

KB

KI

KC

KU

KYE

X

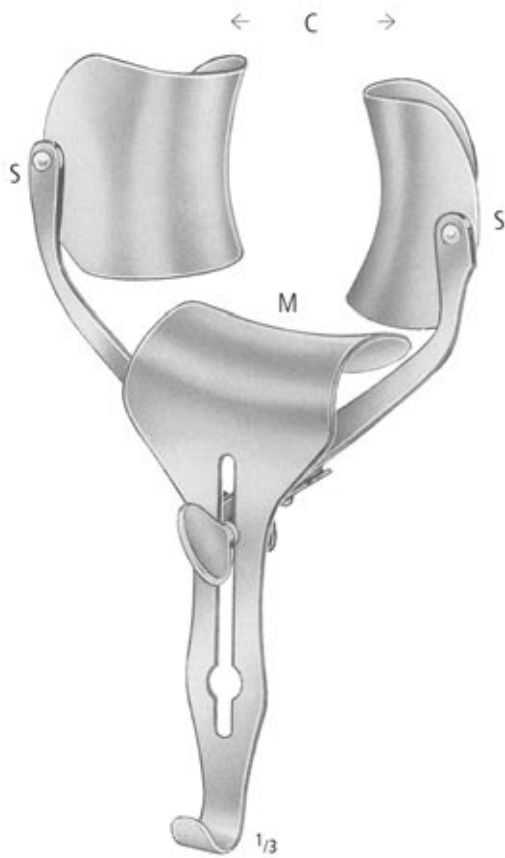

RICARD

	S	M	C
AK 712/28	72 x 85 mm	80 x 90 mm	280 mm
AK 712/30	60 x 80 mm	55 x 70 mm	300 mm

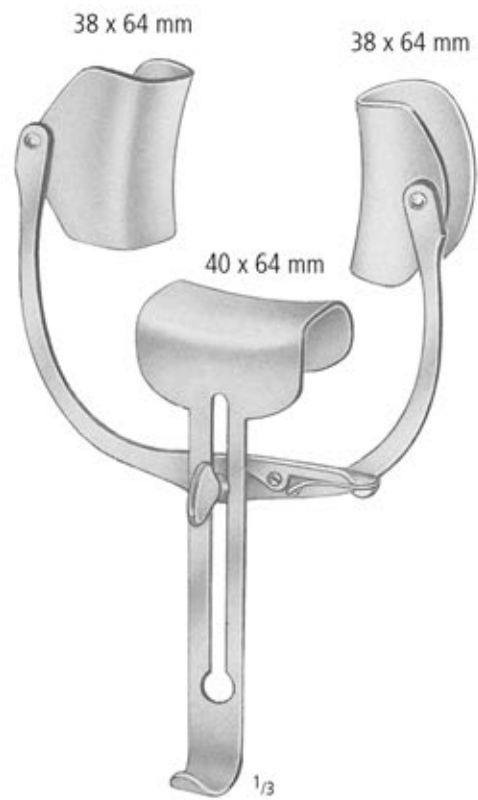

ROBIN-MASSÉ

AK 715/00

Bauchdeckenhalter
 Abdominal Retractors
 Separadores abdominales
 Ecarteurs abdominaux
 Divaricatori addominali



38 x 62 mm	AK 725/06
38 x 80 mm	AK 725/08
38 x 100 mm	AK 725/10

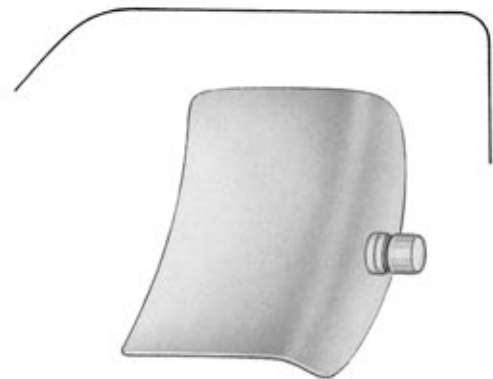

AK 726/80
 62 x 80 mm

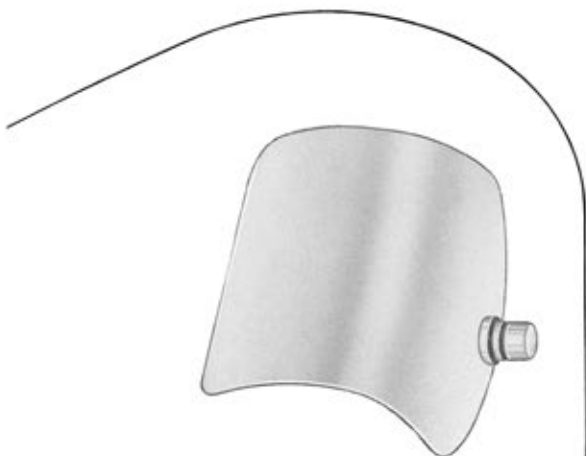

50 x 58 mm	AK 727/58
60 x 80 mm	AK 727/80
72 x 85 mm	AK 727/85



AK 728/80
 62 x 80 mm

WUNDHAKEN RETRACTORS SEPARADORES ECARTEURS DIVARICATORI

Bauchspatel
Abdominal Spatulas
Espátulas abdominales
Spatules abdominales
Spatole addominali

biegsam
malleable
maleables
malléables
malleabili



200 x 12 mm AK 800/12
200 x 17 mm AK 800/17
200 x 25 mm AK 800/25
250 x 25 mm AK 802/25

biegsam
malleable
maleables
malléables
malleabili



33,0 cm/13"

30 mm AK 804/30
40 mm AK 804/40
50 mm AK 804/50

biegsam
malleable
maleables
malléables
malleabili



25 mm

20,0 cm/8"

17 mm

TUFFIER
AK 805/20

biegsam
malleable
maleables
malléables
malleabili



HABERER

25/30 mm	28,0 cm/11"	AK 807/30
37/45 mm	30,0 cm/12"	AK 807/45
40/50 mm	30,0 cm/12"	AK 807/50



45 mm

REVERDIN

AK 809/29
29,0 cm/11½"

60 mm

AA
AB
AC
AD
AE
AF
AK
AL
AO
AP
AR
KB
KI
KC
KU
KYE
X

SONDEN
PROBES
SONDAS
SONDES
SONDE

AL

nopa[®] instruments

Weitere Sonden finden Sie in unserem Katalog „Allgemeines Instrumentarium“ in Gruppe AL.

For further probes kindly refer to our catalogue „General Instruments“, section AL.

Para sondas adicionales, por favor consulte nuestro catálogo de „Instrumental de uso general“, grupo AL.

Pour sondes supplémentaires, consultez notre catalogue „Instrumentation Générale“, section AL.

Per gli altri sonde, consultare il nostro catalogo „Strumentazione Generale“, gruppo AL.



SONDEN PROBES SONDAS SONDES SONDE

Sonden
Probes
Sondas
Sondes
Sonde



Silber
silver
de plata
en argent
d'argento



	1,0 mm	2,0 mm
11,5 cm/4 ¹ / ₂ "	AL 001/11	AL 002/11
13,0 cm/5"	AL 001/13	AL 002/13
14,5 cm/5 ³ / ₄ "	AL 001/14	AL 002/14
16,0 cm/6 ¹ / ₄ "	AL 001/16	AL 002/16
18,0 cm/7"	AL 001/18	AL 002/18
20,0 cm/8"	AL 001/20	AL 002/20
25,0 cm/10"	AL 001/25	AL 002/25

AL 003/11
AL 003/13
AL 003/14
AL 003/16
AL 003/18
AL 003/20
AL 003/25

MYRTLE LEAF

AL 007/14
AL 007/16
AL 007/18
AL 007/20

STACKE

AL 013/10
10,5 cm/4¹/₄"
Ø 1,0 mm

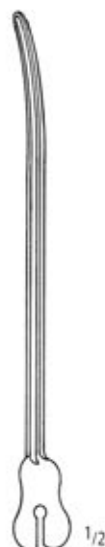

11,5 cm/4 ¹ / ₂ "	AL 015/11
13,0 cm/5"	AL 015/13
14,5 cm/5 ³ / ₄ "	AL 015/14
16,0 cm/6 ¹ / ₄ "	AL 015/16
18,0 cm/7"	AL 015/18
20,0 cm/8"	AL 015/20

DOYEN

AL 017/14

AL 020/11
AL 020/13
AL 020/14
AL 020/16
AL 020/18

NELATON

AL 022/16

AA
AB
AC
AD
AE
AF
AK
AL
AO
AP
AR
KB
KI
KC
KU
KYE
X

AL SONDEN PROBES SONDAS SONDES SONDE

Sonden und Watteträger
 Probes and Cotton Applicators
 Sondas y Porta-algodones
 Sondes et Porte-coton
 Sonde e Portacotone

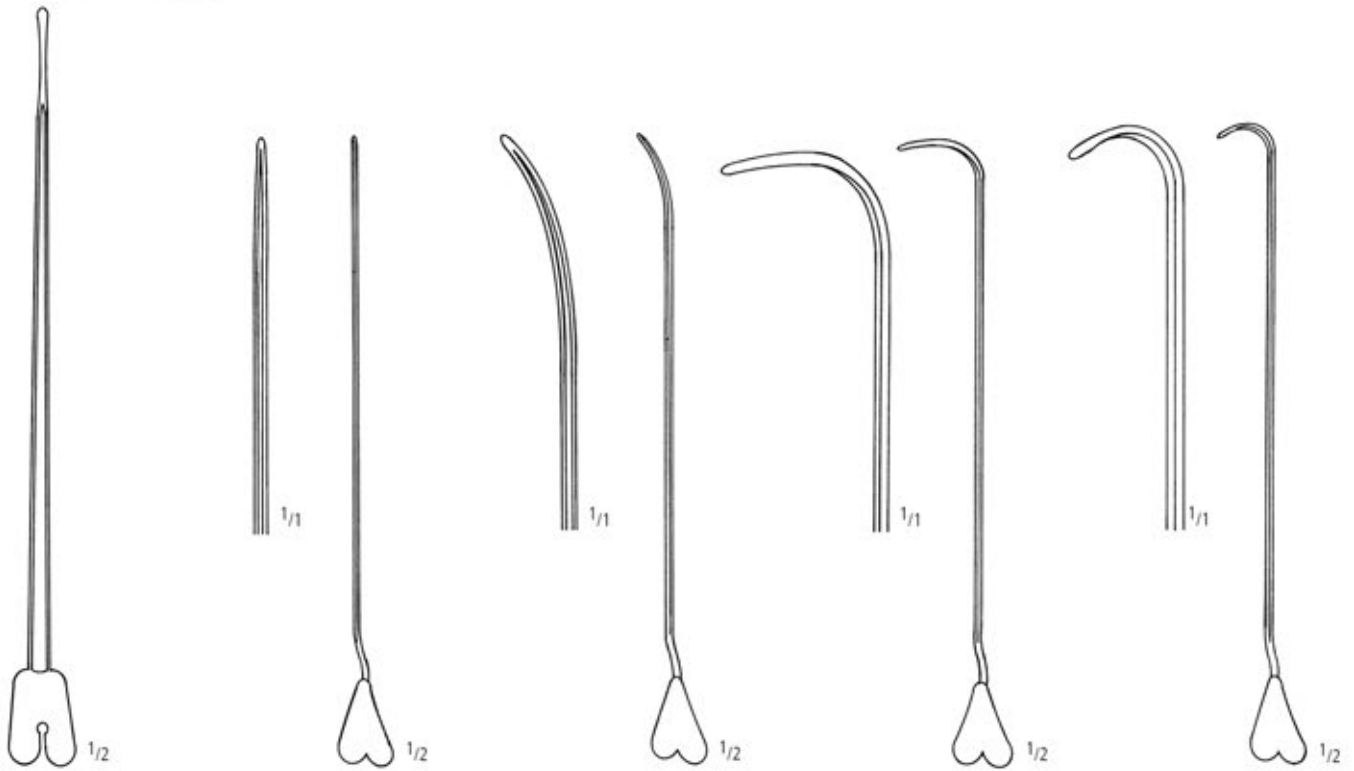

BRODIE

AL 026/20
 20,0 cm/8"

LOCKHART-MUMMERY

Fig. 1
 AL 030/01

Fig. 2
 AL 030/02

LOCKHART-MUMMERY

Fig. 3
 AL 030/03

Fig. 4
 AL 030/04

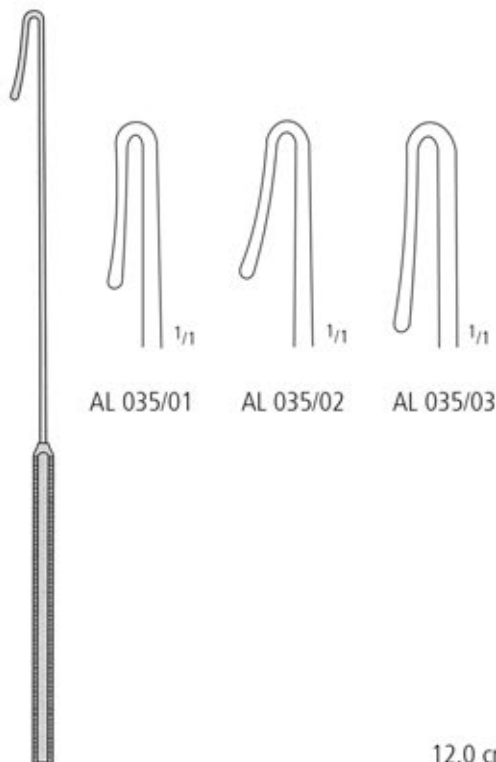

AL 035/01

AL 035/02

AL 035/03

PRATT

21,0 cm/8¹/₄"

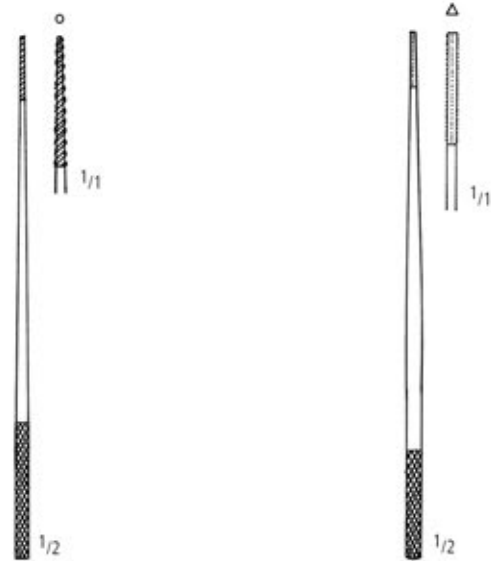

FARRELL

12,0 cm/4³/₄" AL 100/12
 14,0 cm/5¹/₂" AL 100/14
 16,5 cm/6¹/₂" AL 100/16
 18,0 cm/7" AL 100/18

FARRELL

0,9 mm 1,1 mm 1,2 mm 0,9 mm 1,1 mm 1,2 mm
 AL 120/12 AL 120/14 AL 120/16 AL 120/18

SONDEN PROBES SONDAS SONDES SONDE

Watteträger und Krampfader-Besteck
 Cotton Applicators and Varicose Vein Probe Set
 Porta-algodones y sonda para várices
 Porte-coton et trousse à varices
 Portacotone e astuccio per varici

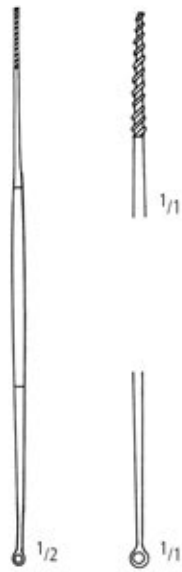

UCKERMANN

AL 160/16
 16,0 cm/6¹/₄"

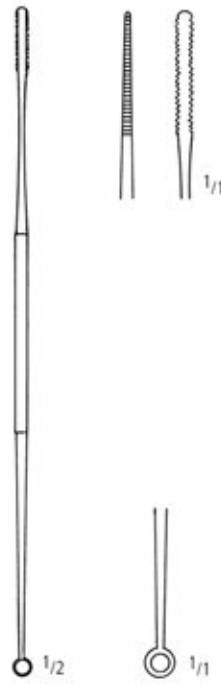

JOBSON-HORNE

AL 162/18
 18,0 cm/7"

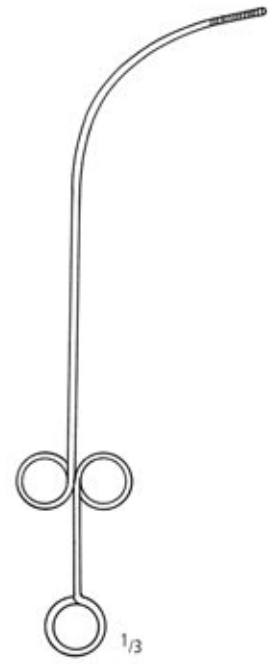

FEIN

AL 170/28
 28,0 cm/11"

AA
 AB
 AC
 AD
 AE
 AF
 AG
 AH
 AI
 AJ
 AK
 AL
 AM
 AN
 AO
 AP
 AQ
 AR
 AS
 AT
 AU
 AV
 AW
 AX

AL SONDEN PROBES SONDAS SONDES SONDE

Gefäß-Dilatatoren
 Vascular Dilators
 Dilatadores vasculares
 Dilatateurs vasculaires
 Dilatatori per vasi

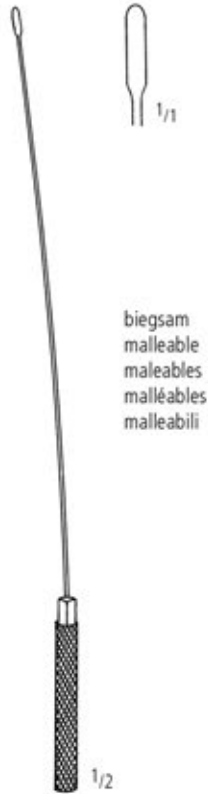

biegsam
 malleable
 malleables
 malléables
 malleabili

- 1,0 mm
- 1,5 mm
- 2,0 mm
- 2,5 mm
- 3,0 mm
- 3,5 mm
- 4,0 mm
- 4,5 mm
- 5,0 mm

- 14,0 cm/5¹/₂"
- AL 190/10
- AL 190/15
- AL 190/20
- AL 190/25
- AL 190/30
- AL 190/35
- AL 190/40
- AL 190/45
- AL 190/50

- 21,0 cm/8¹/₄"
- AL 192/10
- AL 192/15
- AL 192/20
- AL 192/25
- AL 192/30
- AL 192/35
- AL 192/40
- AL 192/45
- AL 192/50

GARRETT

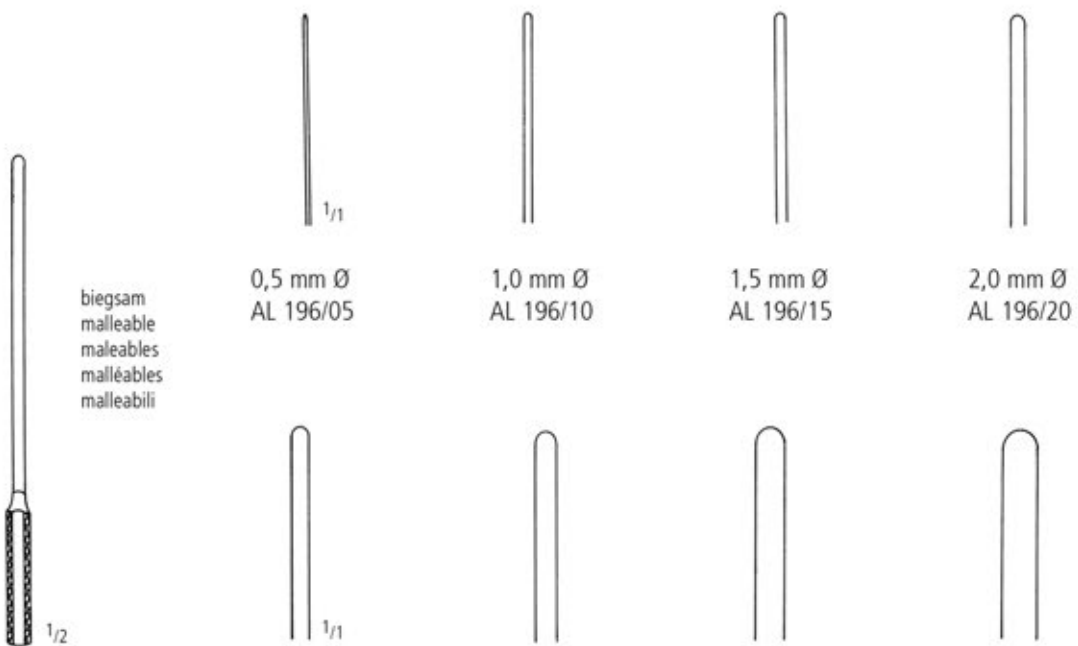

biegsam
 malleable
 malleables
 malléables
 malleabili

0,5 mm Ø
 AL 196/05

1,0 mm Ø
 AL 196/10

1,5 mm Ø
 AL 196/15

2,0 mm Ø
 AL 196/20

2,5 mm Ø
 AL 196/25

3,0 mm Ø
 AL 196/30

4,0 mm Ø
 AL 196/40

5,0 mm Ø
 AL 196/50

COOLEY
 13,0 cm/5"

SONDEN PROBES SONDAS SONDES SONDE

Gefäß-Dilatatoren
 Vascular Dilators
 Dilatadores vasculares
 Dilatateurs vasculaires
 Dilatatori per vasi

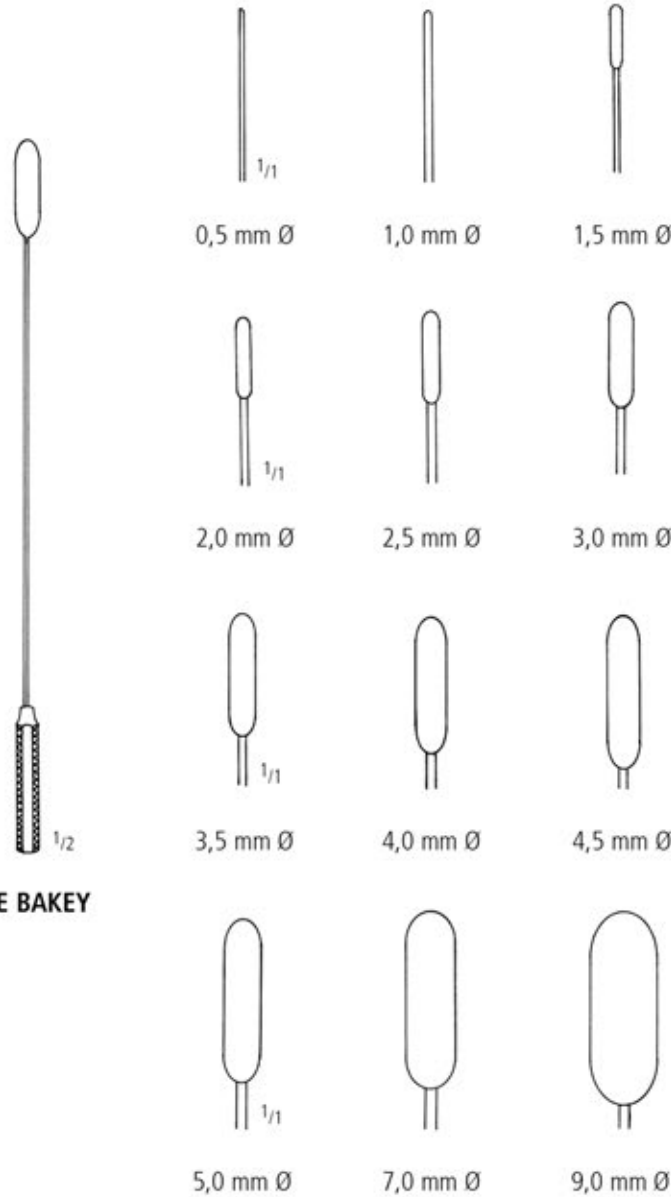

DE BAKEY

biegsam-malleable-maleables-malléables-malleabili

mm Ø	19,0 cm / 7 1/2"	35,0 cm / 14"
0,5	AL 200/05	AL 201/05
1,0	AL 200/10	AL 201/10
1,5	AL 200/15	AL 201/15
2,0	AL 200/20	AL 201/20
2,5	AL 200/25	AL 201/25
3,0	AL 200/30	AL 201/30
3,5	AL 200/35	AL 201/35
4,0	AL 200/40	AL 201/40
4,5	AL 200/45	AL 201/45
5,0	AL 200/50	AL 201/50
7,0	AL 200/70	AL 201/70
9,0	AL 200/90	AL 201/90

AA
AB
AC
AD
AE
AF
AK
AL
AO
AP
AR
KB
KI
KC
KU
KYE
X

AL SONDEN PROBES SONDAS SONDES SONDE

Fasszangen
 Grasping Forceps
 Pinzas para coger
 Pincas pour saisir
 Pinze per afferrare



FRANKENFELDT

AL 248/36
 36,0 cm/14¹/₄"



38,0 cm / 15¹/₄"

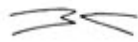

AL 250/38

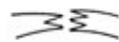

AL 251/38



AL 252/38

PUNKTION/KANÜLEN
PUNCTURE/SPECIAL NEEDLES
PUNCION/AGUJAS ESPECIALES
PONCTION/AIGUILLES SPECIALES
PUNTURA/AGHI SPECIALI

AO

nopa[®] instruments

Weitere Punktion/Kanülen finden Sie in unserem Katalog „Allgemeines Instrumentarium“ in Gruppe AO.

For further puncture/special needles kindly refer to our catalogue „General Instruments“, section AO.

Para puncion/aguja especiales adicionales, por favor consulte nuestro catálogo de „Instrumental de uso general“, grupo AO.

Pour ponction/aiguilles speciales supplémentaires, consultez notre catalogue „Instrumentation Generale“, section AO.

Per gli altri puntura/aghi speciali, consultare il nostro catalogo „Strumentazione Generale“, gruppo AO.



Saugrohre
Suction Tubes
Tubos de aspiración
Canules d'aspiration
Cannule per aspirazione



YANKAUER
AO 400/00
27,0 cm/11"

WALTON-YANKAUER
AO 404/00
32,5 cm/13"

ANDREWS-PYNCHON
AO 406/00
23,5 cm/9¹/₃"

DE BAKEY
AO 408/00
27,5 cm/10³/₄"

Saugrohre
Suction Tubes
Tubos de aspiración
Canules d'aspiration
Cannule per aspirazione



COUPLAND
AO 410/00



BYRD
1,5 mm AO 412/15
2,5 mm AO 412/25
3,5 mm AO 412/35



POOLE
AO 420/22
10,0 mm



POOLE
AO 421/22
8,0 mm



BABY-POOLE
AO 422/20
5,5 mm

AA
AB
AC
AD
AE
AF
AK
AL
AO
AP
AR
KB
KI
KC
KU
KYE
X

Saugrohre
Suction Tubes
Tubos de aspiración
Canules d'aspiration
Cannule per aspirazione

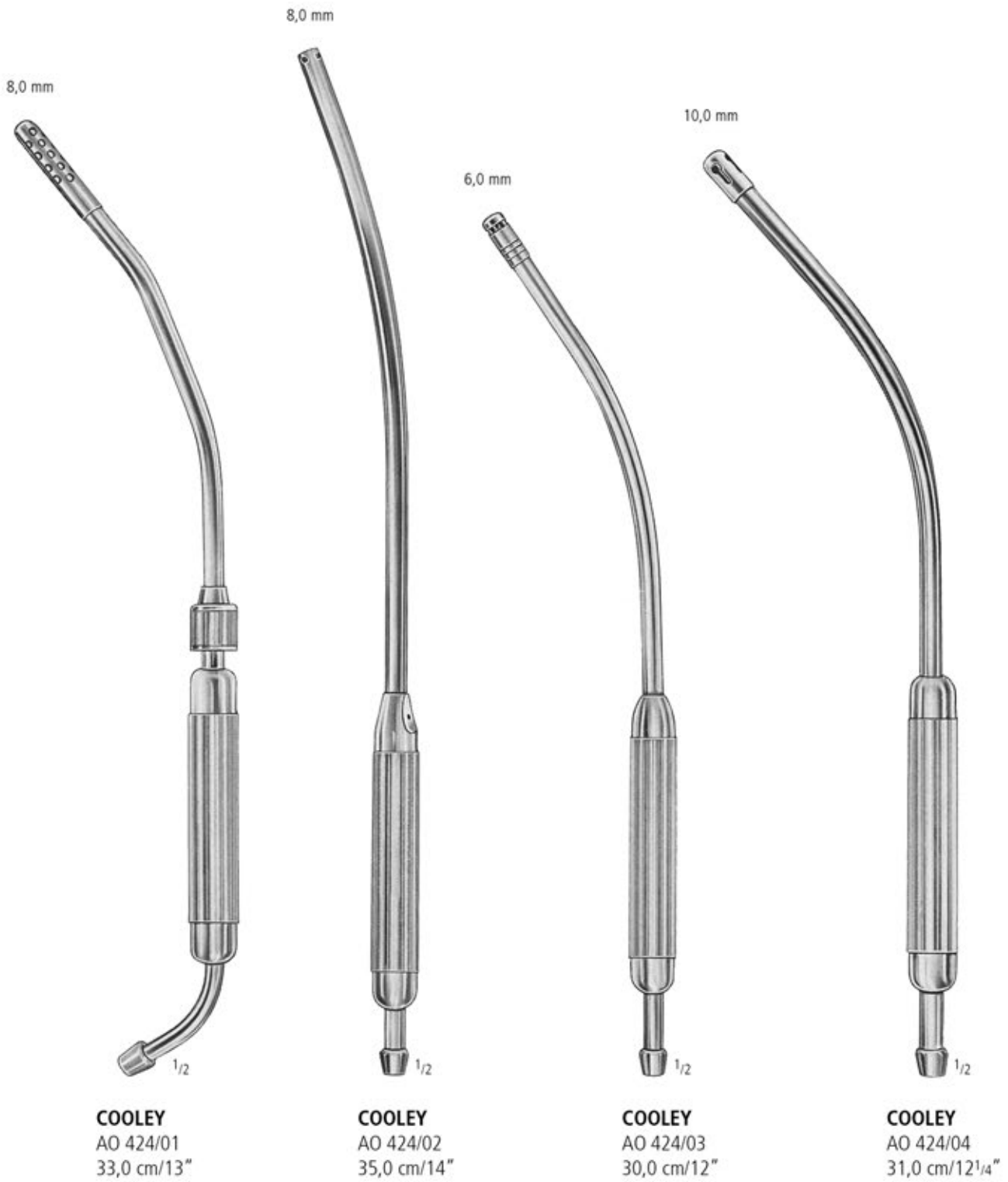

Saugrohre
Suction Tubes
Tubos de aspiración
Canules d'aspiration
Cannule per aspirazione

complete with suction tube
+ cannula 0,4 mm
+ cannula 0,6 mm
+ cannula 0,8 mm



FRAZIER

6 Charr.	AO 430/06
8 Charr.	AO 430/08
10 Charr.	AO 430/10
12 Charr.	AO 430/12

PLESTER

1,5 mm	AO 432/15
2,0 mm	AO 432/20
2,5 mm	AO 432/25
3,0 mm	AO 432/30

FERGUSSON

5 Charr.	AO 434/05
6 Charr.	AO 434/06
7 Charr.	AO 434/07
8 Charr.	AO 434/08
9 Charr.	AO 434/09
10 Charr.	AO 434/10
12 Charr.	AO 434/12

EICKEN-KILLIAN

AO 436/03
13,0 cm/5"
Ø 3 mm

WULLSTEIN MICRO

AO 438/00



	L	L	L	L
	130 mm	150 mm	180 mm	220 mm
Ø 1,5 mm	AO 440/13	AO 440/15	AO 440/18	AO 440/22
Ø 2,0 mm	AO 441/13	AO 441/15	AO 441/18	AO 441/22
Ø 2,5 mm	AO 442/13	AO 442/15	AO 442/18	AO 442/22
Ø 3,5 mm	AO 443/13	AO 443/15	AO 443/18	AO 443/22



ADSON

AO 450/04
21,0 cm/8 ¹ / ₄ "
Ø 4,0 mm

AA
AB
AC
AD
AE
AF
AG
AH
AI
AJ
AK
AL
AO
AP
AR
AS
AT
AU
AV
AW
AX
AY
AZ

Spezialkanülen
Special Needles
Agujas especiales
Aiguilles spéciales
Aghi speciali



SCHMID



3,0 mm
AO 740/03



4,0 mm
AO 740/04



5,0 mm
AO 740/05



6,0 mm
AO 740/06

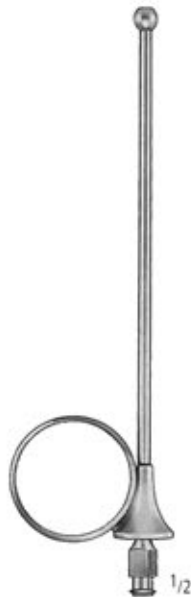

IOWA
AO 750/14
14,0 cm/5 1/2"



VERRES
1,55 x 55 mm AO 780/05
2,00 x 100 mm AO 780/10
2,00 x 120 mm AO 780/12
2,00 x 150 mm AO 780/15

Führungsnadeln
 Guide Needles
 Aguja de guía
 Aiguilles d'introduction
 Aghi per introduzione



Charr./Fr.

8 AO 820/08
 10 AO 820/10
 12 AO 820/12
 14 AO 820/14
 16 AO 820/16
 18 AO 820/18

AO 821/08
 AO 821/10
 AO 821/12
 AO 821/14
 AO 821/16
 AO 821/18

AO 822/08
 AO 822/10
 AO 822/12
 AO 822/14
 AO 822/16
 AO 822/18

AA
 AB
 AC
 AD
 AE
 AF
 AG
 AH
 AI
 AJ
 AK
 AL
AO
 AP
 AR
 AS
 AT
 AU
 AV
 AW
 AX

Spritzen
Syringes
Jeringas
Seringues
Siringhe

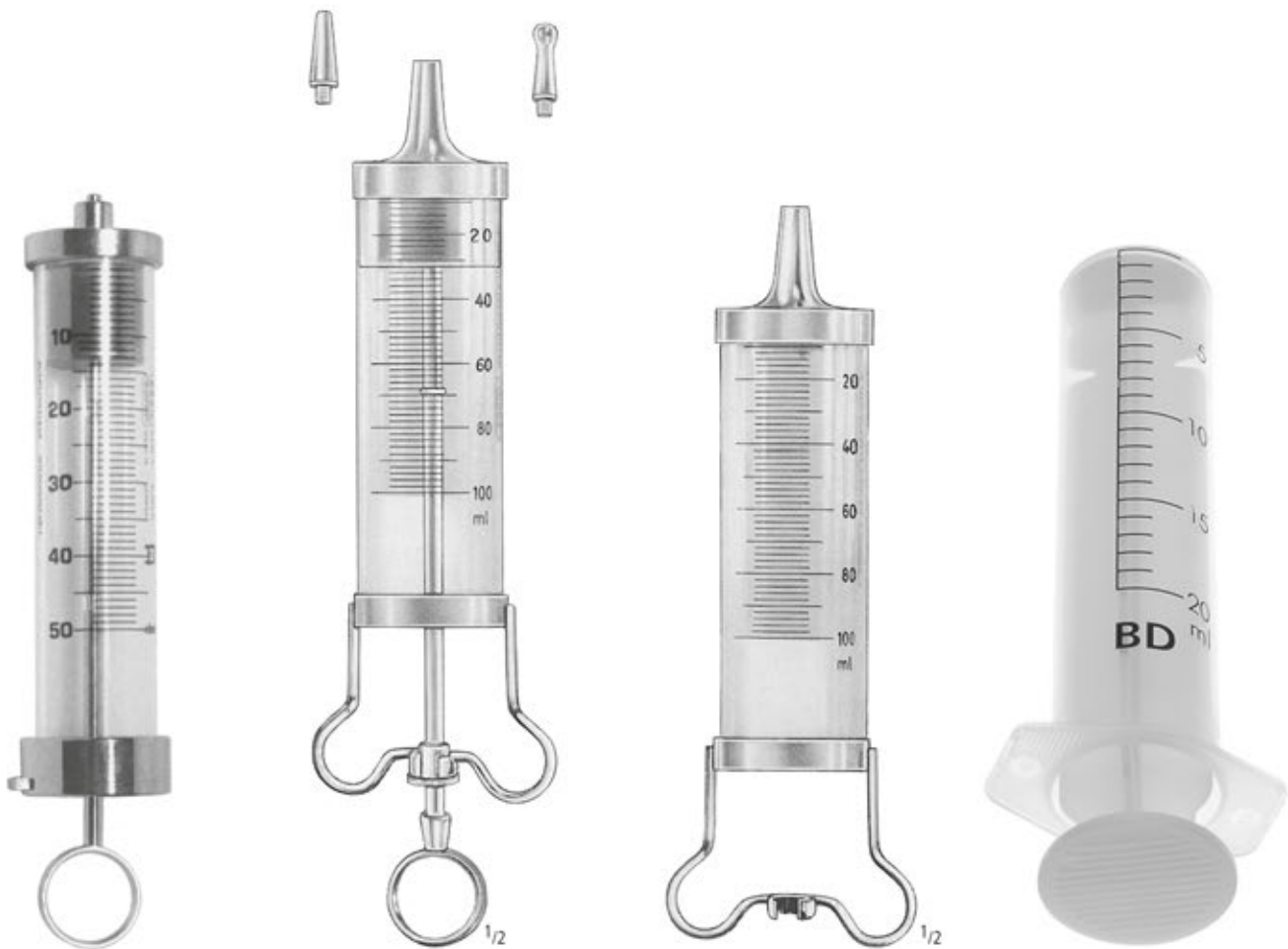

Glasspritze
50 ml AO 869/05

JANET
50 ml AO 870/05
100 ml AO 870/10
150 ml AO 870/15
200 ml AO 870/20

50 ml AO 871/05
100 ml AO 871/10
150 ml AO 871/15
200 ml AO 871/20

Einwegspritze
20 ml AO 875/02
60 ml AO 875/06

Hähne und Verbindungsstücke
 Stopcocks and Connecting Pieces
 Llaves y Piezas de conexión
 Robinets et Raccords
 Rubinetti e Raccordi



AO 910/00



AO 911/00



AO 912/00



AO 913/00



AO 915/00



AO 916/00



AO 917/00



AO 918/00

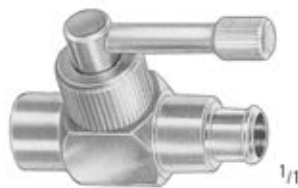

AO 920/00

links
 left
 izquierda
 gauche
 sinistra

AO 921/01



rechts
 right
 derecha
 droite
 destra

AO 921/02



AO 922/00



AO 923/00



AO 924/00



AO 925/00

AA
 AB
 AC
 AD
 AE
 AF
 AG
 AH
 AI
 AJ
 AK
 AL
 AM
 AN
 AO
 AP
 AQ
 AR
 AS
 AT
 AU
 AV
 AW
 AX
 AY
 AZ

NARKOSE
ANAESTHESIA
ANESTESIA
ANESTHESIE
ANESTESIA

AP

nopa[®] instruments



Laryngoskope
Laryngoscopes
Laringoscopios
Laryngoscopes
Laringoscopi



AP 252/00
Fig. 0, 55 mm



AP 252/01
Fig. 1, 75 mm



AP 252/02
Fig. 2, 90 mm



AP 252/03
Fig. 3, 110 mm



AP 252/04
Fig. 4, 135 mm

McINTOSH

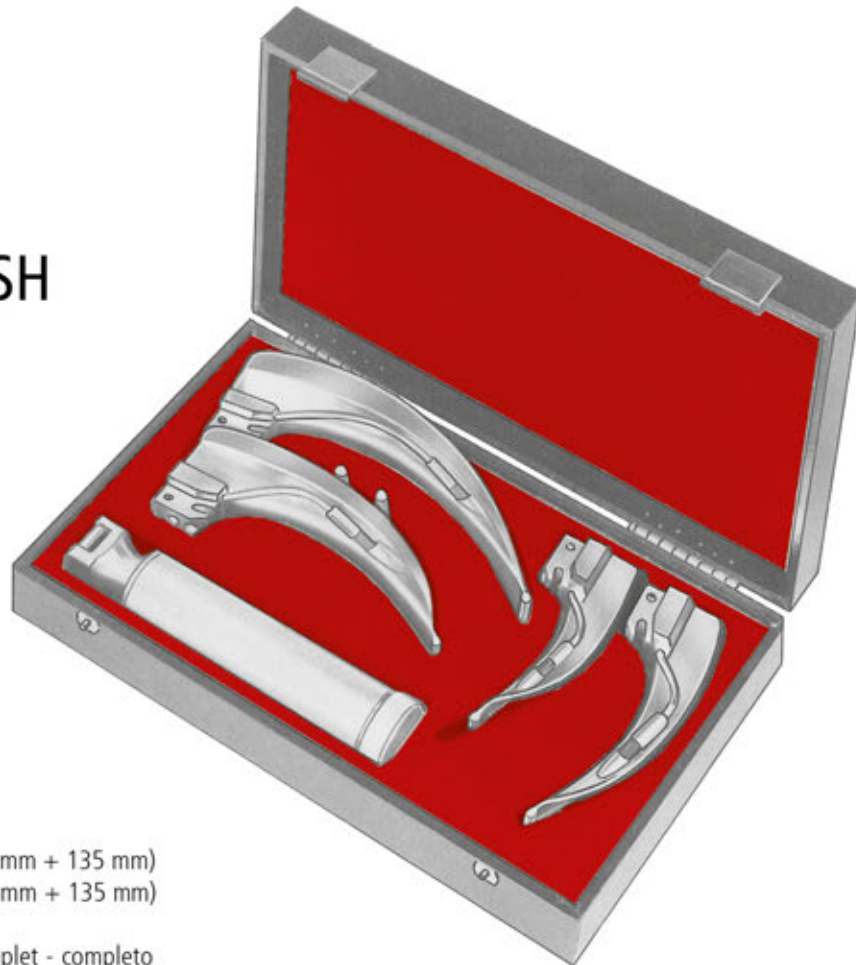

AP 250/00 (90 mm + 110 mm + 135 mm)

AP 250/01 (75 mm + 90 mm + 110 mm + 135 mm)

komplett - complete - completo - complet - completo

AA
AB
AC
AD
AE
AF
AK
AL
AO
AP
AR
KB
KI
KC
KU
KYE
X

Laryngoskope
Laryngoscopes
Laringoscopios
Laryngoscopes
Laringoscopi



AP 262/00
Fig. 0, 70 mm



AP 262/01
Fig. 1, 95 mm



AP 262/02
Fig. 2, 110 mm



AP 262/03
Fig. 3, 140 mm



AP 262/04
Fig. 4, 170 mm



FOREGGER (WISCONSIN)



AP 260/00 (110 mm + 140 mm + 170 mm)

AP 260/01 (95 mm + 110 mm + 140 mm + 170 mm)

komplett - complete - completo - complet - completo

Laryngoskope
Laryngoscopes
Laringoscopios
Laryngoscopes
Laringoscopi

AA
AB
AC
AD
AE
AF
AK
AL
AO
AP
AR
KB
KI
KC
KU
KYE
X



AP 272/00
Fig. 0, 55 mm



AP 272/01
Fig. 1, 80 mm



AP 272/02
Fig. 2, 130 mm



AP 272/03
Fig. 3, 170 mm



AP 272/04
Fig. 4, 180 mm



MILLER



AP 270/00 (130 mm + 170 mm + 180 mm)

AP 270/01 (80 mm + 130 mm + 170 mm + 180 mm)

komplett - complete - completo - complet - completo

Laryngoskope
Laryngoscopes
Laringoscopios
Laryngoscopes
Laringoscopi



AP 280/19
Ø 19 mm



AP 280/28
Ø 28 mm



AP 280/37
Ø 37 mm

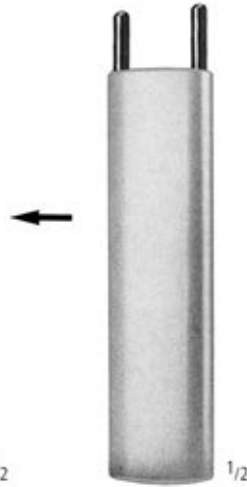

AP 281/00



AP 282/00
Fig. 2-4



AP 284/00
Fig. 0-1

Kaltlicht Laryngoskope
 Fibre Optic Laryngoscopes
 Laringoscopios con luz fría
 Laryngoscopes à lumière froide
 Laringoscopi a luce fredda

McINTOSH FIBRE OPTIC

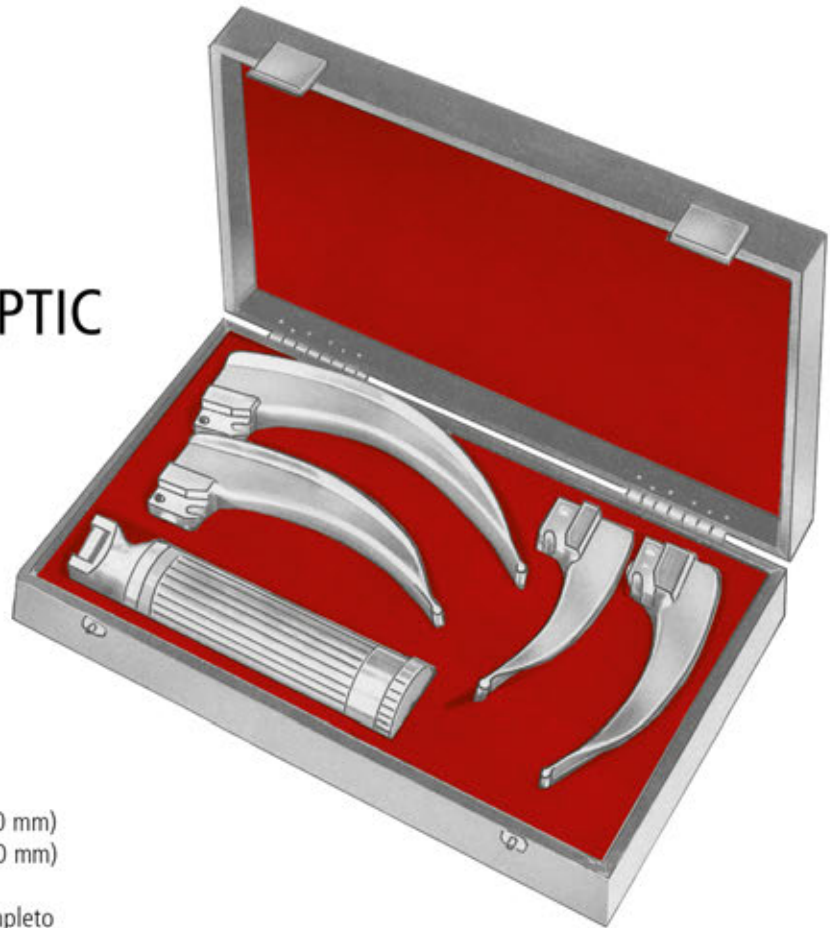

AP 300/00 (80 mm + 105 mm + 130 mm)
 AP 300/01 (70 mm + 80 mm + 105 mm + 130 mm)

komplett - complete - completo - complet - completo



- | | | |
|---------|--------|-----------|
| Fig. 0, | 55 mm | AP 302/00 |
| Fig. 1, | 70 mm | AP 302/01 |
| Fig. 2, | 80 mm | AP 302/02 |
| Fig. 3, | 105 mm | AP 302/03 |
| Fig. 4, | 130 mm | AP 302/04 |

AA
AB
AC
AD
AE
AF
AK
AL
AO
AP
AR
KB
KI
KC
KU
KYE
X

Kaltlicht Laryngoskope
 Fibre Optic Laryngoscopes
 Laringoscopios con luz fría
 Laryngoscopes à lumière froide
 Laringoscopi a luce fredda

FOREGGER (WISCONSIN) FIBRE OPTIC



AP 310/00 (110 mm + 140 mm + 170 mm)
 AP 310/01 (95 mm + 110 mm + 140 mm + 170 mm)

komplett - complete - completo - complet - completo



- | | | |
|---------|--------|-----------|
| Fig. 0, | 70 mm | AP 312/00 |
| Fig. 1, | 95 mm | AP 312/01 |
| Fig. 2, | 110 mm | AP 312/02 |
| Fig. 3, | 140 mm | AP 312/03 |
| Fig. 4, | 170 mm | AP 312/04 |

Kaltlicht Laryngoskope
 Fibre Optic Laryngoscopes
 Laringoscopios con luz fría
 Laryngoscopes à lumière froide
 Laringoscopi a luce fredda

MILLER FIBRE OPTIC



AP 320/00 (80 mm + 130 mm + 170 mm)
 AP 320/01 (80 mm + 130 mm + 170 mm + 180 mm)

komplett - complete - completo - complet - completo



- | | | |
|---------|--------|-----------|
| Fig. 0, | 55 mm | AP 322/00 |
| Fig. 1, | 80 mm | AP 322/01 |
| Fig. 2, | 130 mm | AP 322/02 |
| Fig. 3, | 170 mm | AP 322/03 |
| Fig. 4, | 180 mm | AP 322/04 |

AA
 AB
 AC
 AD
 AE
 AF
 AG
 AH
 AI
 AJ
 AK
 AL
 AM
 AN
 AO
 AP
 AQ
 AR
 AS
 AT
 AU
 AV
 AW
 AX
 AY
 AZ

Kaltlicht Laryngoskope
 Fibre Optic Laryngoscopes
 Laringoscopios con luz fría
 Laryngoscopes à lumière froide
 Laringoscopi a luce fredda

FIBRE OPTIC



AP 340/00
 Ø 30 mm



AP 341/00
 Ø 20 mm



AP 345/01
 2,5 V
 Halogen



AP 345/02
 2,5 V
 Krypton

Katheterzangen
Catheter Forceps
Pinzas para catéteres
Pincas pour sondes
Pinze per cannule

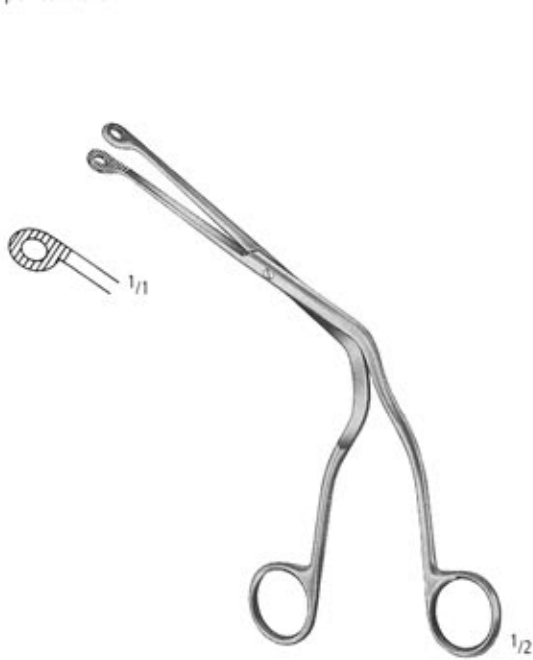

MAGILL
AP 410/16
16,0 cm/6¹/₄"



MAGILL
AP 410/20
20,0 cm/8"



MAGILL
AP 410/25
25,0 cm/10"

AA
AB
AC
AD
AE
AF
AK
AL
AO
AP
AR
KB
KI
KC
KU
KYE
X

Anschluss Richard Wolf, Adapter oder andere Anschlüsse auf Wunsch
 Richard Wolf connector, adaptor or other connectors on request
 Conector Richard Wolf, adaptador o otros conectores diferentes sobre pedido
 Connection Richard Wolf, adaptateur ou d'autres embouts à la demande
 Connettore Richard Wolf, adattatori ed altri connettori su richiesta

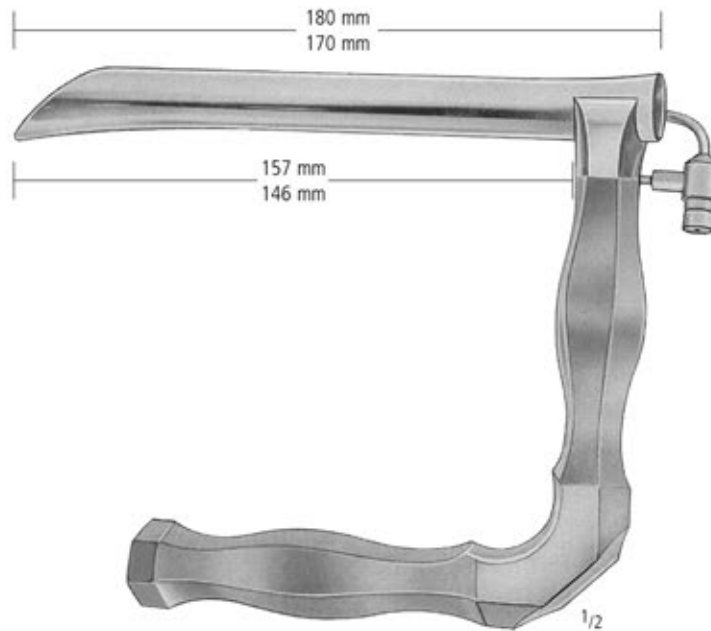

HOLINGER

157 mm = AP 455/01
 146 mm = AP 455/02

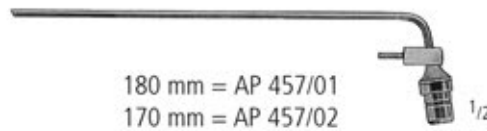

180 mm = AP 457/01
 170 mm = AP 457/02

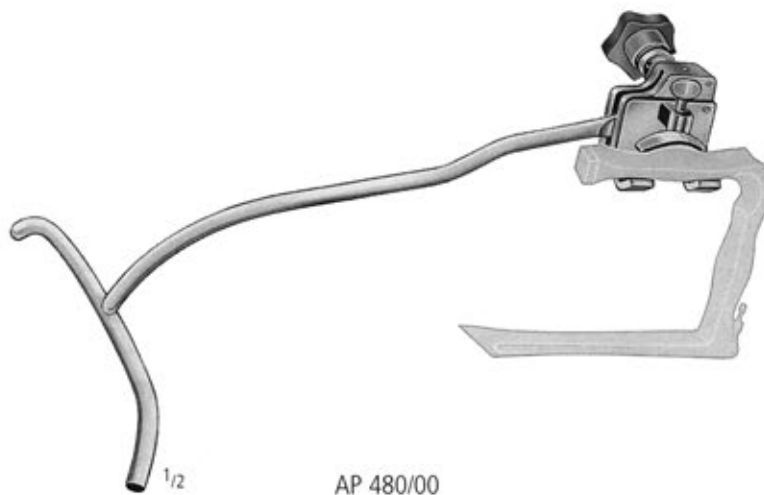

AP 480/00

Kaltlicht Laryngoskope
 Fibre Optic Laryngoscopes
 Laringoscopios con luz fría
 Laryngoscopes à lumière froide
 Laringoscopi a luce fredda

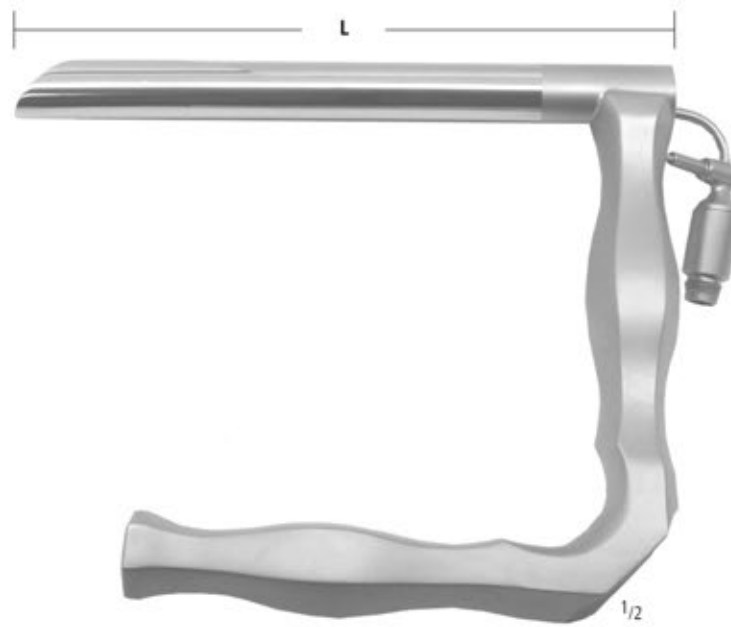

JACKSON

- L = 120 mm = AP 465/12
- L = 160 mm = AP 465/16
- L = 180 mm = AP 465/18



- 120 mm = AP 470/12
- 160 mm = AP 470/16
- 180 mm = AP 470/18

AA
 AB
 AC
 AD
 AE
 AF
 AK
 AL
 AO
AP
 AR
 KB
 KI
 KC
 KU
 KYE
 X

DIAGNOSTIK
DIAGNOSTICS
DIAGNOSTICO
DIAGNOSTIC
DIAGNOSTICA

AR

nopa[®] instruments

Weitere Diagnostik-Instrumente finden Sie in unserem Katalog „Allgemeines Instrumentarium“ in Gruppe AR.

For further diagnostics instruments kindly refer to our catalogue „General Instruments“, section AR.

Para instrumentos diagnostico adicionales, por favor consulte nuestro catálogo de „Instrumental de uso general“ grupo AR.

Pour des instruments diagnostic supplémentaires, consultez notre catalogue „Instrumentation Generale“, section AR.

Per gli altri accessori diagnostica consultare il nostro catalogo „Strumentazione Generale“, gruppo AR.



Stirnspiegel
Head Mirrors
Espejos frontales
Miroirs frontaux
Specchi frontali



AR 091/01
Ersatzlampe
Spare Lamp
Lámpara de repuesto
Lampe de rechange
Lampada di ricambio

AR 090/00

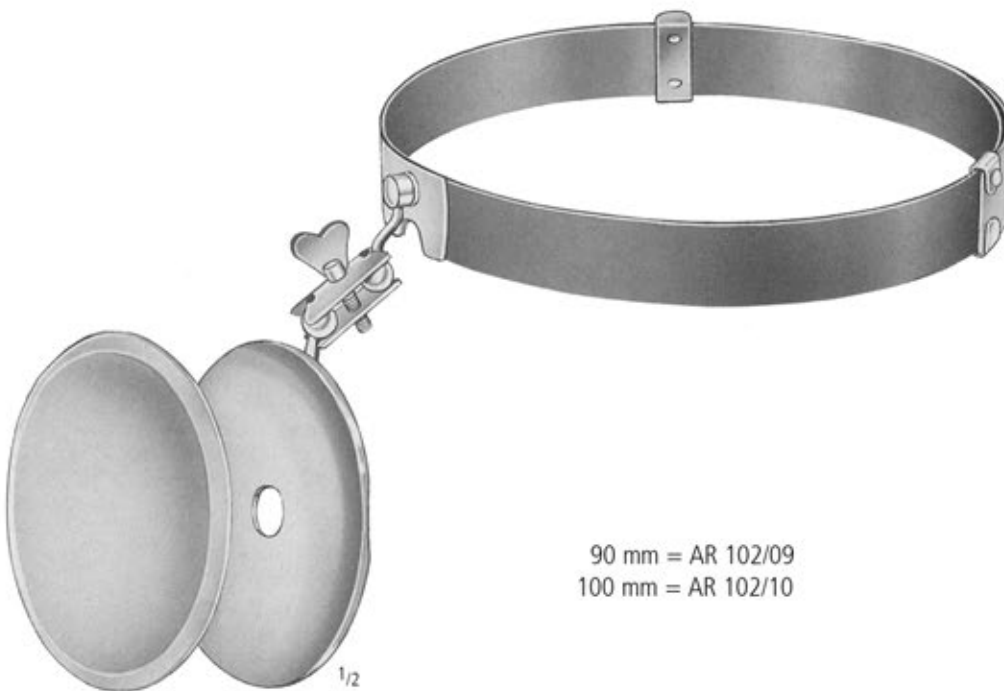

90 mm = AR 102/09
100 mm = AR 102/10

AA
AB
AC
AD
AE
AF
AK
AL
AO
AP
AR
KB
KI
KC
KU
KYE
X

Stirnlampen
Head Lamps
Lámparas frontales
Eclaireurs frontaux
Lampade frontali



CLAR 55
AR 150/55
6 V



CLAR STANDARD
AR 160/00
6 V

DIAGNOSTIK DIAGNOSTICS DIAGNOSTICO DIAGNOSTIC DIAGNOSTICA

Messinstrumente
 Measuring instruments
 Instrumentos para medidas
 Instruments pour mesurer
 Strumenti per misurare



15,0 cm/6" AR 250/15
 20,0 cm/8" AR 250/20
 30,0 cm/12" AR 250/30
 50,0 cm/20" AR 250/50



AR 256/15



AR 258/50
 50,0 cm/20" röntgenfähig
 x-ray
 rayos x
 rayons x
 raggi x

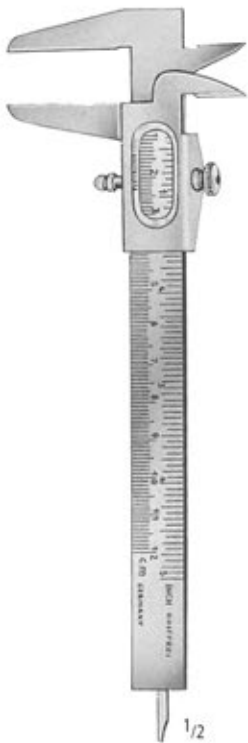

VERNIER
 AR 260/12
 12,0 cm/4³/₄"



JAMESON
 AR 261/08
 0 - 80 mm
 0 - 3 inch



THORPE
 AR 261/58
 0 - 80 mm
 0 - 3 inch

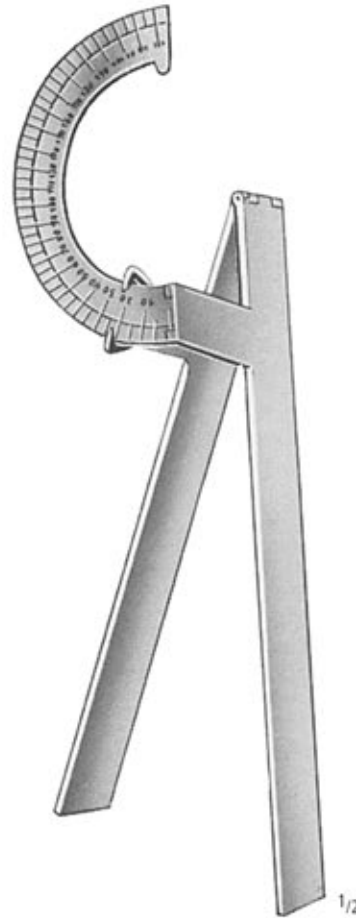

MOELTGEN
 AR 268/00

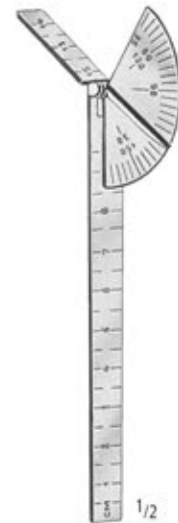

CAROLL
 AR 270/00

AA
 AB
 AC
 AD
 AE
 AF
 AG
 AH
 AI
 AJ
 AK
 AL
 AM
 AN
 AO
 AP
 AR
 AS
 AT
 AU
 AV
 AW
 AX

Stethoskope
 Stethoscopes
 Estetoscopios
 Stéthoscopes
 Stetoscopi



aus Holz
 of wood
 de madera
 en bois
 in legno

1/2

PINARD
 AR 310/01



aus Aluminium
 of aluminium
 de aluminio
 en aluminium
 in alluminio

1/2

PINARD
 AR 310/02



aus Plastik
 of plastic
 de plástica
 en plastique
 in plastica

1/2

PINARD
 AR 310/03

Stethoskope
Stethoscopes
Estetoscopios
Stéthoscopes
Stetoscopi



CADIOPHON
AR 321/00



DUPLEX-LIGHTWEIGHT/BABY
AR 322/00 100 g

AA
AB
AC
AD
AE
AF
AK
AL
AO
AP
AR
KB
KI
KC
KU
KYE
X

Blutdruckmesser
Blood Pressure Manometers
Manómetro para la presión de la sangre
Tensiomètre à mercure
Sfigmomanometro a mercurio



mit Velcromanschette
with velcro cuff
con brazaletes velcro
avec manchette velcro
con bracciale velcro

DIPLOMAT
AR 350/00

Blutdruckmesser
Blood Pressure Manometers
Manómetro para la presión de la sangre
Tensiomètre à mercure
Sfigmomanometro a mercurio



PRECISA
AR 352/00

AA

AB

AC

AD

AE

AF

AK

AL

AO

AP

AR

KB

KI

KC

KU

KYE

X

GYNÄKOLOGIE
GYNECOLOGY
GINECOLOGIA
GYNECOLOGIE
GINECOLOGIA

KB

nopa[®] instruments

GYN ECOLOGY



Scheidenspekula
Vaginal Specula
Espéculos vaginales
Spéculums vaginaux
Specoli vaginali

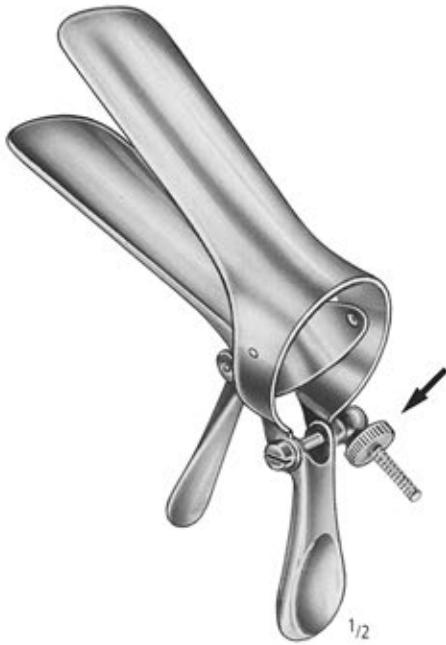

CUSCO

75 x 32 mm KB 020/01
85 x 35 mm KB 020/02
100 x 35 mm KB 020/03



CUSCO-VIRGIN

KB 022/00
75 x 17 mm

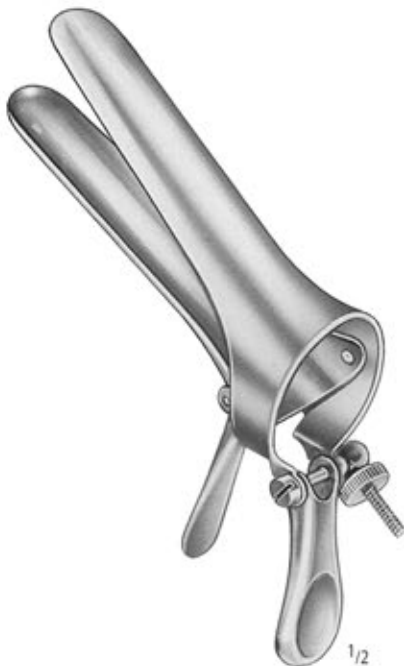

CUSCO-SUISSE

80 x 22 mm KB 024/01
100 x 25 mm KB 024/02
105 x 27 mm KB 024/03



CUSCO

74 x 32 mm KB 026/01
85 x 35 mm KB 026/02
100 x 37 mm KB 026/03

AA
AB
AC
AD
AE
AF
AK
AL
AO
AP
AR
KB
KI
KC
KU
KYE
X

Scheidenspekula
 Vaginal Specula
 Espécules vaginales
 Spéculums vaginaux
 Specoli vaginali

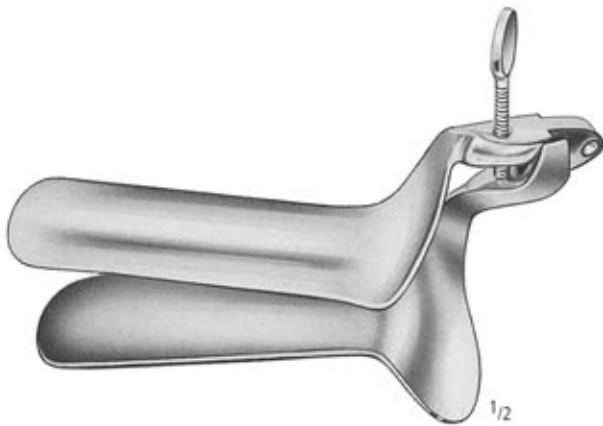
**COLLIN**

85 x 30 mm	KB 030/01
100 x 35 mm	KB 030/02
110 x 40 mm	KB 030/03

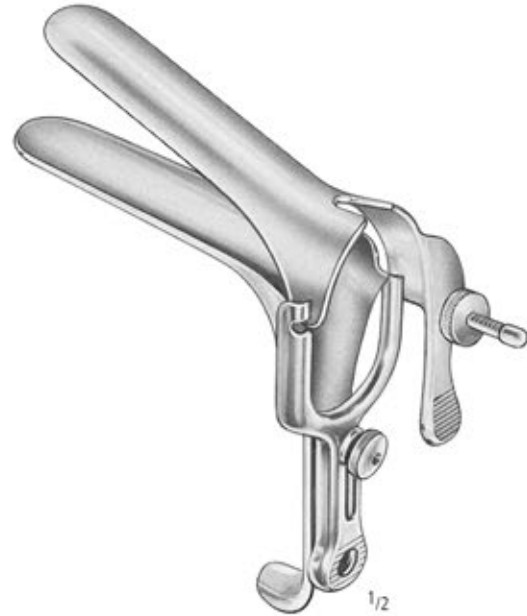
**PEDERSON**

75 x 13 mm	KB 038/01
100 x 22 mm	KB 038/02
120 x 25 mm	KB 038/03

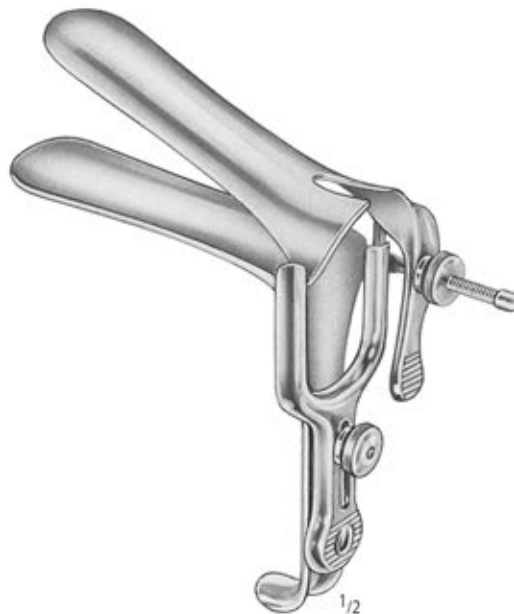
**GRAVE**

75 x 20 mm	KB 040/01
95 x 35 mm	KB 040/02
115 x 35 mm	KB 040/03

Scheidenspekula
 Vaginal Specula
 Espéculos vaginales
 Spéculums vaginaux
 Specoli vaginali

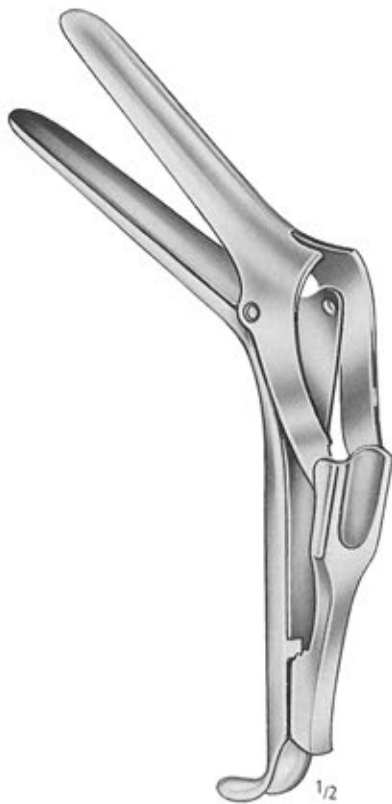

SEMM

90 x 14/18 mm KB 042/00
 100 x 17/20 mm KB 042/01
 100 x 25/30 mm KB 042/02

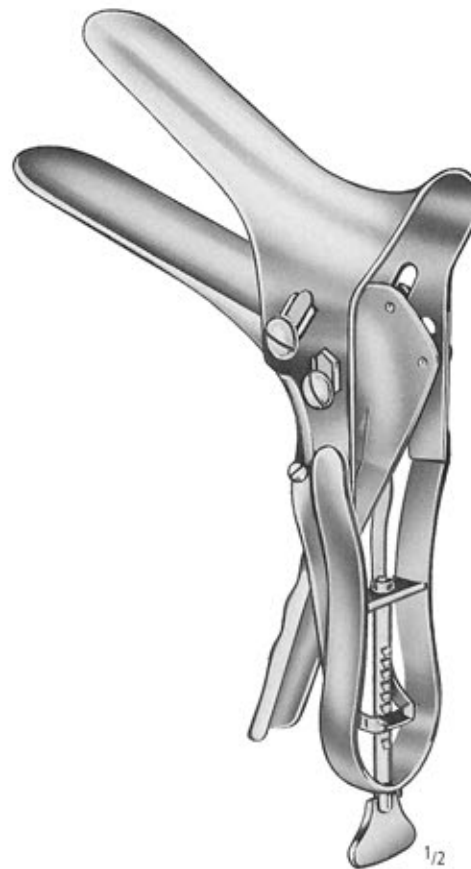

SEYFFERT

100 x 17 mm KB 043/01
 110 x 33 mm KB 043/02

AA
 AB
 AC
 AD
 AE
 AF
 AG
 AH
 AI
 AJ
 AK
 AL
 AM
 AN
 AO
 AP
 AQ
 AR
 AS
 AT
 AU
 AV
 AW
 AX
 AY
 AZ
 BA
 BB
 BC
 BD
 BE
 BF
 BG
 BH
 BI
 BJ
 BK
 BL
 BM
 BN
 BO
 BP
 BQ
 BR
 BS
 BT
 BU
 BV
 BW
 BX
 BY
 BZ
 CA
 CB
 CC
 CD
 CE
 CF
 CG
 CH
 CI
 CJ
 CK
 CL
 CM
 CN
 CO
 CP
 CQ
 CR
 CS
 CT
 CU
 CV
 CW
 CX
 CY
 CZ
 DA
 DB
 DC
 DD
 DE
 DF
 DG
 DH
 DI
 DJ
 DK
 DL
 DM
 DN
 DO
 DP
 DQ
 DR
 DS
 DT
 DU
 DV
 DW
 DX
 DY
 DZ
 EA
 EB
 EC
 ED
 EE
 EF
 EG
 EH
 EI
 EJ
 EK
 EL
 EM
 EN
 EO
 EP
 EQ
 ER
 ES
 ET
 EU
 EV
 EW
 EX
 EY
 EZ
 FA
 FB
 FC
 FD
 FE
 FF
 FG
 FH
 FI
 FJ
 FK
 FL
 FM
 FN
 FO
 FP
 FQ
 FR
 FS
 FT
 FU
 FV
 FW
 FX
 FY
 FZ
 GA
 GB
 GC
 GD
 GE
 GF
 GG
 GH
 GI
 GJ
 GK
 GL
 GM
 GN
 GO
 GP
 GQ
 GR
 GS
 GT
 GU
 GV
 GW
 GX
 GY
 GZ
 HA
 HB
 HC
 HD
 HE
 HF
 HG
 HH
 HI
 HJ
 HK
 HL
 HM
 HN
 HO
 HP
 HQ
 HR
 HS
 HT
 HU
 HV
 HW
 HX
 HY
 HZ
 IA
 IB
 IC
 ID
 IE
 IF
 IG
 IH
 II
 IJ
 IK
 IL
 IM
 IN
 IO
 IP
 IQ
 IR
 IS
 IT
 IU
 IV
 IW
 IX
 IY
 IZ
 JA
 JB
 JC
 JD
 JE
 JF
 JG
 JH
 JI
 JJ
 JK
 JL
 JM
 JN
 JO
 JP
 JQ
 JR
 JS
 JT
 JU
 JV
 JW
 JX
 JY
 JZ
 KA
 KB
 KC
 KD
 KE
 KF
 KG
 KH
 KI
 KJ
 KK
 KL
 KM
 KN
 KO
 KP
 KQ
 KR
 KS
 KT
 KU
 KV
 KW
 KX
 KY
 KZ
 LA
 LB
 LC
 LD
 LE
 LF
 LG
 LH
 LI
 LJ
 LK
 LL
 LM
 LN
 LO
 LP
 LQ
 LR
 LS
 LT
 LU
 LV
 LW
 LX
 LY
 LZ
 MA
 MB
 MC
 MD
 ME
 MF
 MG
 MH
 MI
 MJ
 MK
 ML
 MM
 MN
 MO
 MP
 MQ
 MR
 MS
 MT
 MU
 MV
 MW
 MX
 MY
 MZ
 NA
 NB
 NC
 ND
 NE
 NF
 NG
 NH
 NI
 NJ
 NK
 NL
 NM
 NN
 NO
 NP
 NQ
 NR
 NS
 NT
 NU
 NV
 NW
 NX
 NY
 NZ
 OA
 OB
 OC
 OD
 OE
 OF
 OG
 OH
 OI
 OJ
 OK
 OL
 OM
 ON
 OO
 OP
 OQ
 OR
 OS
 OT
 OU
 OV
 OW
 OX
 OY
 OZ
 PA
 PB
 PC
 PD
 PE
 PF
 PG
 PH
 PI
 PJ
 PK
 PL
 PM
 PN
 PO
 PP
 PQ
 PR
 PS
 PT
 PU
 PV
 PW
 PX
 PY
 PZ
 QA
 QB
 QC
 QD
 QE
 QF
 QG
 QH
 QI
 QJ
 QK
 QL
 QM
 QN
 QO
 QP
 QQ
 QR
 QS
 QT
 QU
 QV
 QW
 QX
 QY
 QZ
 RA
 RB
 RC
 RD
 RE
 RF
 RG
 RH
 RI
 RJ
 RK
 RL
 RM
 RN
 RO
 RP
 RQ
 RR
 RS
 RT
 RU
 RV
 RW
 RX
 RY
 RZ
 SA
 SB
 SC
 SD
 SE
 SF
 SG
 SH
 SI
 SJ
 SK
 SL
 SM
 SN
 SO
 SP
 SQ
 SR
 SS
 ST
 SU
 SV
 SW
 SX
 SY
 SZ
 TA
 TB
 TC
 TD
 TE
 TF
 TG
 TH
 TI
 TJ
 TK
 TL
 TM
 TN
 TO
 TP
 TQ
 TR
 TS
 TT
 TU
 TV
 TW
 TX
 TY
 TZ
 UA
 UB
 UC
 UD
 UE
 UF
 UG
 UH
 UI
 UJ
 UK
 UL
 UM
 UN
 UO
 UP
 UQ
 UR
 US
 UT
 UU
 UV
 UW
 UX
 UY
 UZ
 VA
 VB
 VC
 VD
 VE
 VF
 VG
 VH
 VI
 VJ
 VK
 VL
 VM
 VN
 VO
 VP
 VQ
 VR
 VS
 VT
 VU
 VV
 VW
 VX
 VY
 VZ
 WA
 WB
 WC
 WD
 WE
 WF
 WG
 WH
 WI
 WJ
 WK
 WL
 WM
 WN
 WO
 WP
 WQ
 WR
 WS
 WT
 WU
 WV
 WW
 WX
 WY
 WZ
 XA
 XB
 XC
 XD
 XE
 XF
 XG
 XH
 XI
 XJ
 XK
 XL
 XM
 XN
 XO
 XP
 XQ
 XR
 XS
 XT
 XU
 XV
 XW
 XX
 XY
 XZ
 YA
 YB
 YC
 YD
 YE
 YF
 YG
 YH
 YI
 YJ
 YK
 YL
 YM
 YN
 YO
 YP
 YQ
 YR
 YS
 YT
 YU
 YV
 YW
 YX
 YY
 YZ
 ZA
 ZB
 ZC
 ZD
 ZE
 ZF
 ZG
 ZH
 ZI
 ZJ
 ZK
 ZL
 ZM
 ZN
 ZO
 ZP
 ZQ
 ZR
 ZS
 ZT
 ZU
 ZV
 ZW
 ZX
 ZY
 ZZ

KB

KI

KC

KU

KYE

X

Scheidenspekula mit Absaugung
 Vaginal Specula with Suction Tube
 Espécules vaginales con tubo de succión
 Spéculums vaginaux avec canule d'aspiration
 Specoli vaginali con tubo d'aspirazione

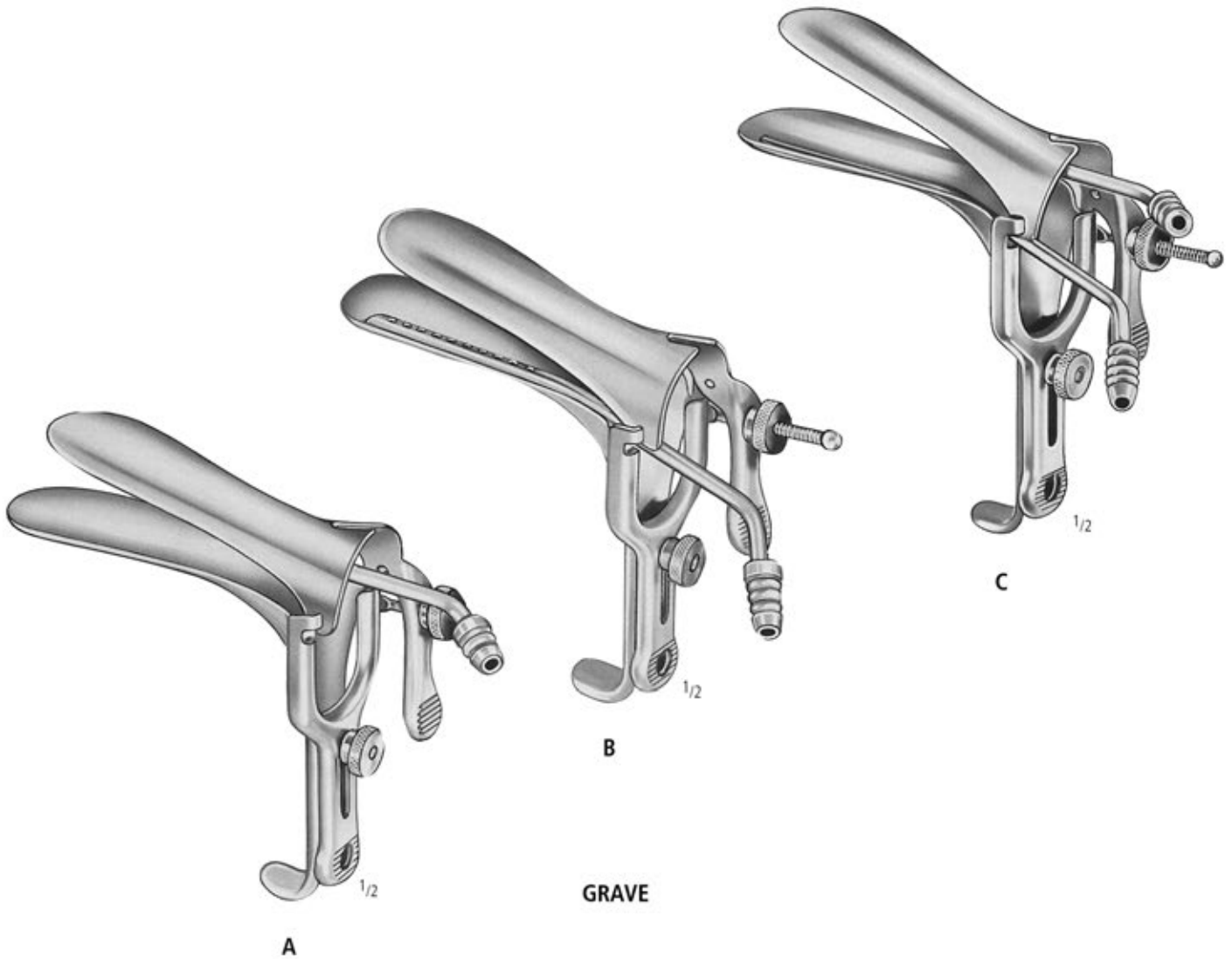

- A** Absaugung am oberen Blatt
 Suction tube on upper blade
 Tubo de succión a la valva superior
 Canule d'aspiration à la lame supérieure
 Canula d'aspirazione alla valva superiore
- B** Absaugung am unteren Blatt
 Suction tube on lower blade
 Tubo de succión a la valva inferior
 Canule d'aspiration à la lame inférieure
 Canula d'aspirazione alla valva inferiore
- C** Absaugung am oberen und unteren Blatt
 Suction tube on upper and lower blade
 Tubo de succión a la valva superior y inferior
 Canule d'aspiration à la lame supérieure et inférieure
 Canula d'aspirazione alla valva superiore e inferiore

	A	B	C
76 x 13 mm	KB 045/11	KB 045/21	KB 045/31
120 x 35 mm	KB 045/13	KB 045/23	KB 045/33

Scheidenspekula mit Absaugung
 Vaginal Specula with Suction Tube
 Espécules vaginales con tubo de succión
 Spéculum vaginaux avec canule d'aspiration
 Specoli vaginali con tubo d'aspirazione

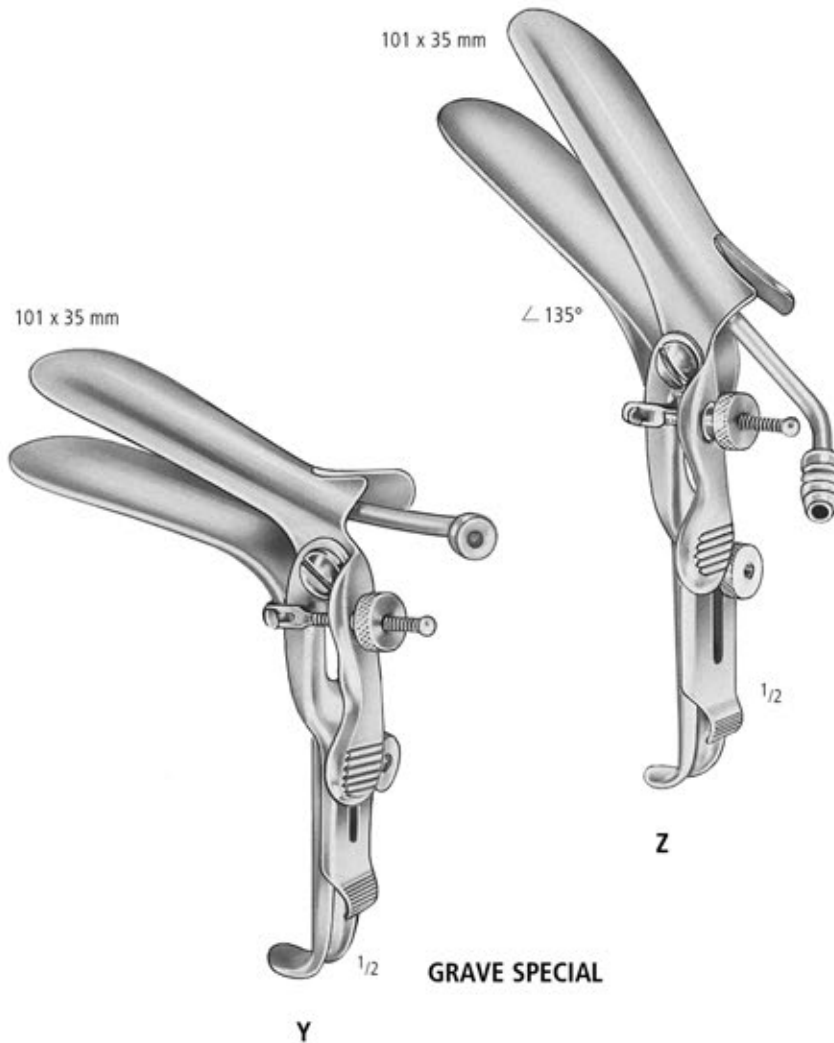

GRAVE SPECIAL

A Absaugung am oberen Blatt
 Suction tube on upper blade
 Tubo de succión a la valva superior
 Canule d'aspiration à la lame supérieure
 Canula d'aspirazione alla valva superiore

B Absaugung am unteren Blatt
 Suction tube on lower blade
 Tubo de succión a la valva inferior
 Canule d'aspiration à la lame inférieure
 Canula d'aspirazione alla valva inferiore

C Absaugung am oberen und unteren Blatt
 Suction tube on upper and lower blade
 Tubo de succión a la valva superior y inferior
 Canule d'aspiration à la lame supérieure et inférieure
 Canula d'aspirazione alla valva superiore e inferiore

Y Rechte Seite offen
 Right side open
 Apertura lateral derecha
 Ouverture à droite
 Lato destro aperto

Z 135° abgewinkelt und rechte Seite offen
 135° angled and right side open
 Angulo de 135° y apertura lateral derecha
 Angulation 135° et ouverture à droite
 Angolato 135° e lato destro aperto

	Y	Z
A	KB 046/12	KB 046/13
B	KB 046/22	KB 046/23
C	KB 046/32	KB 046/33

AA
AB
AC
AD
AE
AF
AK
AL
AO
AP
AR
KB
KI
KC
KU
KYE
X

Scheidenspekula mit Absaugung
 Vaginal Specula with Suction Tube
 Espécules vaginales con tubo de succión
 Spéculums vaginaux avec canule d'aspiration
 Specoli vaginali con tubo d'aspirazione



PEDERSON

		A	B	C
A	Absaugung am oberen Blatt Suction tube on upper blade Tubo de succión a la valva superior Canule d'aspiration à la lame supérieure Canula d'aspirazione alla valva superiore	76 x 13 mm KB 047/11	KB 047/21	KB 047/31
		101 x 22 mm KB 047/12	KB 047/22	KB 047/32
		120 x 25 mm KB 047/13	KB 047/23	KB 047/33
B	Absaugung am unteren Blatt Suction tube on lower blade Tubo de succión a la valva inferior Canule d'aspiration à la lame inférieure Canula d'aspirazione alla valva inferiore			
C	Absaugung am oberen und unteren Blatt Suction tube on upper and lower blade Tubo de succión a la valva superior y inferior Canule d'aspiration à la lame supérieure et inférieure Canula d'aspirazione alla valva superiore e inferiore			

Scheidenspekula
 Vaginal Specula
 Espécules vaginales
 Spéculum vaginaux
 Specoli vaginali



SIMS
 KB 050/01
 60 x 25/30 mm



SIMS
 KB 050/02
 70 x 30/35 mm



SIMS
 KB 050/03
 80 x 35/40 mm

KB 050/00 = KB 050/01
 KB 050/02
 KB 050/03

AA
 AB
 AC
 AD
 AE
 AF
 AK
 AL
 AO
 AP
 AR
KB
 KI
 KC
 KU
 KYE
 X

Scheidenspekula
Vaginal Specula
Espécúlos vaginales
Spéculums vaginaux
Specoli vaginali

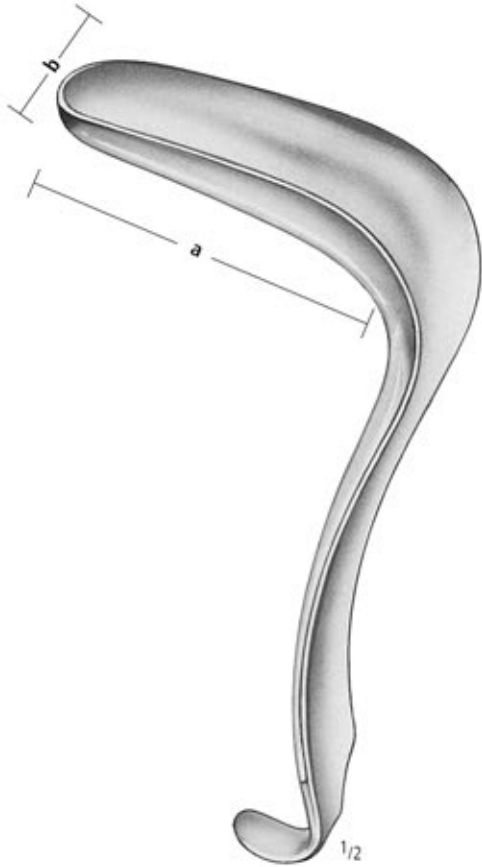

KRISTELLER



KRISTELLER



KRISTELLER



	a	b	
Fig. 1	70 x 27 mm		KB 053/01
Fig. 2	80 x 30 mm		KB 053/02
Fig. 3	90 x 36 mm		KB 053/03

konisch
conically
cónica
conique
conica

Fig. 00	105 x 18 mm		KB 056/00
Fig. 0	105 x 21 mm		KB 056/10



Fig. 1	105 x 26 mm		KB 059/01
Fig. 2	105 x 28 mm		KB 059/02
Fig. 3	105 x 33 mm		KB 059/03



Fig. 1	110 x 27 mm		KB 062/01
Fig. 2	110 x 30 mm		KB 062/02
Fig. 3	110 x 36 mm		KB 062/03

	a	b	
	75 x 23 mm		KB 054/01
	85 x 26 mm		KB 054/02
	100 x 32 mm		KB 054/03

	110 x 14 mm		KB 057/00
	110 x 17 mm		KB 057/10

	115 x 22 mm		KB 060/01
	115 x 24 mm		KB 060/02
	115 x 29 mm		KB 060/03

	115 x 23 mm		KB 063/01
	115 x 26 mm		KB 063/02
	115 x 32 mm		KB 063/03

KB 055/01	=	KB 053/01	+	KB 054/01
KB 055/02	=	KB 053/02	+	KB 054/02
KB 055/03	=	KB 053/03	+	KB 054/03

KB 058/00	=	KB 056/00	+	KB 057/00
KB 058/10	=	KB 056/10	+	KB 057/10

KB 061/01	=	KB 059/01	+	KB 060/01
KB 061/02	=	KB 059/02	+	KB 060/02
KB 061/03	=	KB 059/03	+	KB 060/03

KB 064/01	=	KB 062/01	+	KB 063/01
KB 064/02	=	KB 062/02	+	KB 063/02
KB 064/03	=	KB 062/03	+	KB 063/03

Scheidenspekula
Vaginal Specula
Espéculos vaginales
Spéculums vaginaux
Specoli vaginali

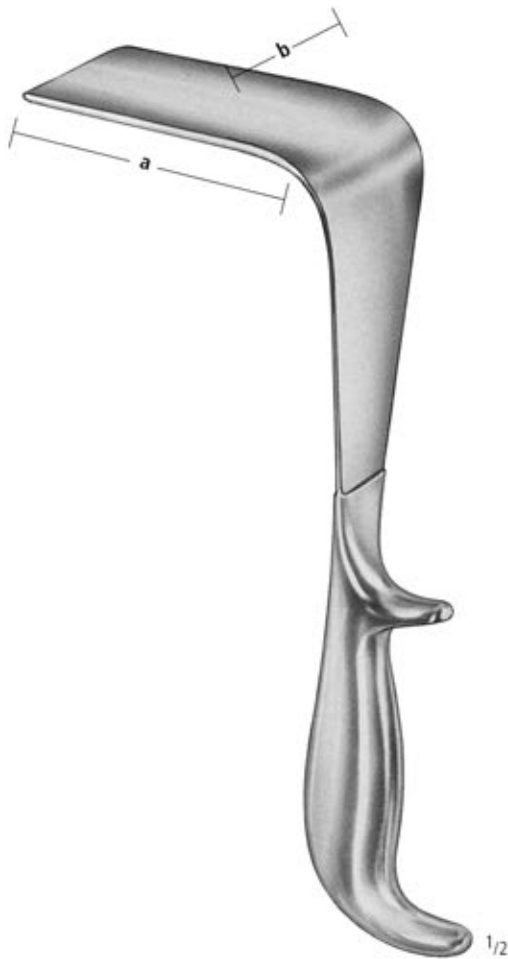

DOYEN



WEISSBARTH
KB 073/20

	a	b	
Fig. 1	55 x 35 mm		KB 070/01
Fig. 2	85 x 35 mm		KB 070/02
Fig. 3	115 x 35 mm		KB 070/03
Fig. 1	55 x 45 mm		KB 070/11
Fig. 2	85 x 45 mm		KB 070/12
Fig. 3	115 x 45 mm		KB 070/13
Fig. 1	55 x 60 mm		KB 070/21
Fig. 2	85 x 60 mm		KB 070/22
Fig. 3	115 x 60 mm		KB 070/23

AA

AB

AC

AD

AE

AF

AK

AL

AO

AP

AR

KB

KI

KC

KU

KYE

X

Scheidenspekula
Vaginal Specula
Espécúlos vaginales
Spéculums vaginaux
Specoli vaginali



KB 078/20

SCHERBACK

400 g = KB 078/40
800 g = KB 078/80



KB 078/10



KB 078/11



KB 078/12



KB 078/13



KB 078/14

Sondermaße und Gewichte auf Anfrage
Special sizes and weights on request
Tamaños y pesos especiales a solicitud
Poids et dimensions spéciales sur demande
Pesi e dimensioni speciali su richiesta



AUVARD

a **b**
80 x 38 mm
102 x 45 mm

KB 080/01
KB 080/02

KB 078/05 = KB 078/10
KB 078/11
KB 078/12
KB 078/13
KB 078/14
KB 078/20
KB 078/40

KB 079/05 = KB 078/10
KB 078/11
KB 078/12
KB 078/13
KB 078/14
KB 078/20
KB 078/80

Scheidenspekula und Scheidenhalter
 Vaginal Specula and Retractors
 Espéculos y valvas vaginales
 Spéculums et valves vaginaux
 Specoli e valve vaginali

AA
AB
AC
AD
AE
AF
AK
AL
AO
AP
AR
KB
KI
KC
KU
KYE
X

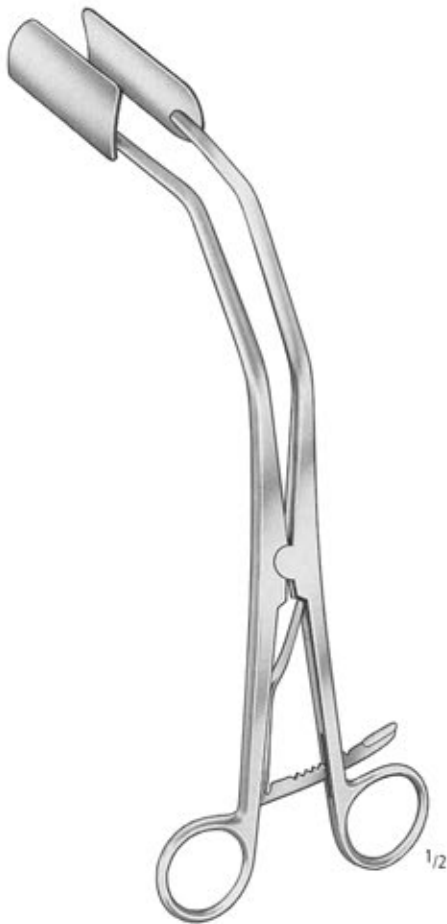

NEW PORT
 KB 082/00
 25,0 cm/10"

NEU: **Vaginalspekulum für die seitlichen Wände**
 Dieser Halter passt in Ihr Cusco Spekulum. Die konkave Form und die abgerundeten Kanten garantieren ein sicheres, gewebeschonendes Zurückhalten der seitlichen Scheidenwände. Dadurch erhalten Sie wesentlich bessere Sicht für alle Ihre gynäkologischen Eingriffe.

NEW: **Lateral Vaginal Retractor**
 This retractor was especially designed to fit inside your vaginal speculum. This simultaneous use with a standard speculum like Grave or Pederson will avoid collapse of the vaginal walls. This will give you a much better field of view, which is of utmost importance for all gynecological procedures. The concave shape of the blades and the rounded edges will guarantee a smooth retraction of the tissue.



BREISKY

- | | |
|-------------|-----------|
| 100 x 20 mm | KB 090/20 |
| 100 x 25 mm | KB 090/25 |
| 100 x 30 mm | KB 090/30 |
| 100 x 35 mm | KB 090/35 |
| 100 x 40 mm | KB 090/40 |
| 130 x 20 mm | KB 093/20 |
| 130 x 25 mm | KB 093/25 |
| 130 x 30 mm | KB 093/30 |
| 130 x 35 mm | KB 093/35 |
| 130 x 40 mm | KB 093/40 |
| 155 x 40 mm | KB 095/40 |



LANDAU

- | | |
|-------------|-----------|
| 105 x 28 mm | KB 096/28 |
| 105 x 38 mm | KB 096/38 |

Weitere Halter in Gruppe AK
 For further retractors see section AK
 Para otros separadores vea el grupo AK
 Pour d'autres écarteurs voir la section AK
 Per altri tipi di divaricatori consultare il gruppo AK

Wundspreizer, Vulvaspreizer, Scheidenspecula
 Retractors, Vaginal Specula
 Separadores, Espéculos Vaginales
 Ecarteurs, Ecarteurs pubiens, Spéculum vaginaux
 Divaricatore, Divaricatore per vulva, Specoli vaginali

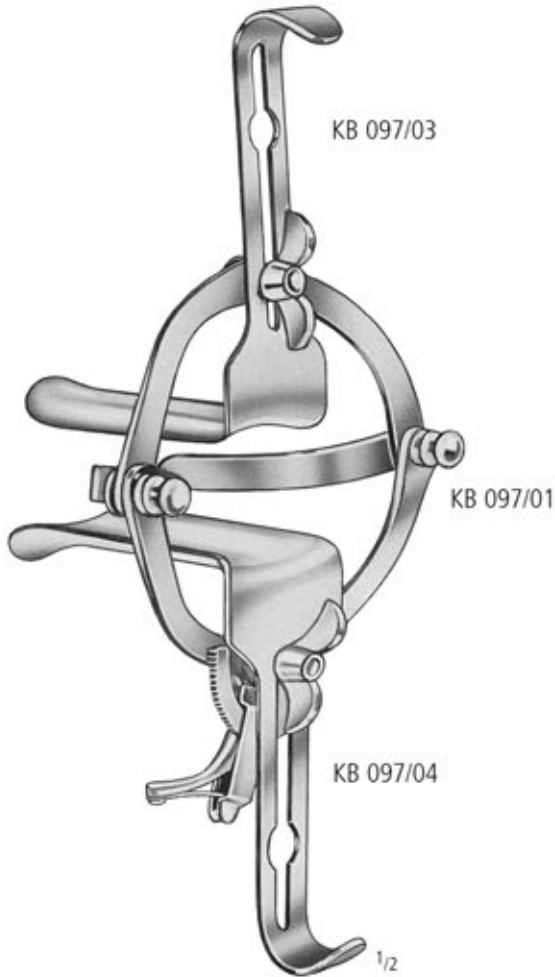

KB 097/03

KB 097/01

KB 097/04

¹/₂

O'SULLIVAN - O'CONNOR
 KB 097/00 = 1 x KB 097/01
 1 x KB 097/02
 1 x KB 097/03
 1 x KB 097/04

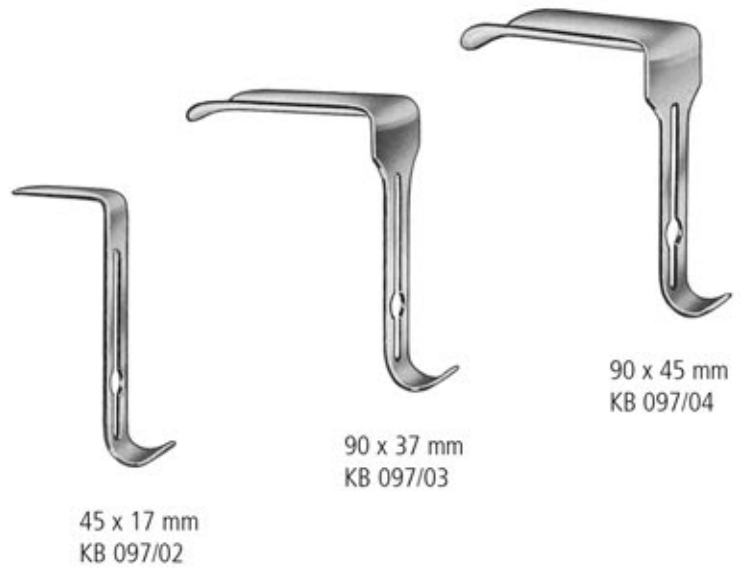

45 x 17 mm
 KB 097/02

90 x 37 mm
 KB 097/03

90 x 45 mm
 KB 097/04

Weitere Wundspreizer in Gruppe AK
 For further retractors see section AK
 Para otros separadores vea el grupo AK
 Pour d'autres écarteurs voir la section AK
 Per altri tipi di divaricatori consultare il gruppo AK



¹/₂

FRIEDMANN
 KB 098/00 10,0 cm/4"
 KB 098/16 15,5 cm/6"

Endospekula
 Endospecula
 Endospéculos
 Endospéculums
 Endospecoli

AA
 AB
 AC
 AD
 AE
 AF
 AK
 AL
 AO
 AP
 AR
KB
 KI
 KC
 KU
 KYE
 X



KOGAN
 KB 099/01
 24,0 cm/9 1/2"

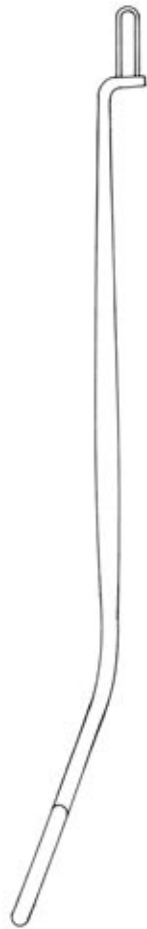

KOGAN
 KB 099/02
 24,0 cm/9 1/2"



KOGAN
 24,0 cm/9 1/2"
 3 mm KB 099/03
 7 mm KB 099/07



Uterus-Dilatatoren
 Uterine Dilators
 Dilatadores uterinos
 Dilatateurs du col de l'utérus
 Dilatatori uterini

- 1,0 mm KB 100/02
- 2,0 mm KB 100/04
- 3,0 mm KB 100/06
- 4,0 mm KB 100/08
- 5,0 mm KB 100/10
- 6,0 mm KB 100/12
- 7,0 mm KB 100/14
- 8,0 mm KB 100/16
- 9,0 mm KB 100/18
- 10,0 mm KB 100/20
- 11,0 mm KB 100/22
- 12,0 mm KB 100/24
- 13,0 mm KB 100/26
- 14,0 mm KB 100/28
- 15,0 mm KB 100/30
- 16,0 mm KB 100/32
- 17,0 mm KB 100/34
- 18,0 mm KB 100/36
- 19,0 mm KB 100/38
- 20,0 mm KB 100/40
- 21,0 mm KB 100/42
- 22,0 mm KB 100/44
- 23,0 mm KB 100/46
- 24,0 mm KB 100/48
- 25,0 mm KB 100/50
- 26,0 mm KB 100/52
- 27,0 mm KB 100/54
- 28,0 mm KB 100/56
- 29,0 mm KB 100/58
- 30,0 mm KB 100/60

- 1,5 mm KB 100/03
- 2,5 mm KB 100/05
- 3,5 mm KB 100/07
- 4,5 mm KB 100/09
- 5,5 mm KB 100/11
- 6,5 mm KB 100/13
- 7,5 mm KB 100/15
- 8,5 mm KB 100/17
- 9,5 mm KB 100/19
- 10,5 mm KB 100/21
- 11,5 mm KB 100/23
- 12,5 mm KB 100/25
- 13,5 mm KB 100/27
- 14,5 mm KB 100/29
- 15,5 mm KB 100/31
- 16,5 mm KB 100/33
- 17,5 mm KB 100/35
- 18,5 mm KB 100/37
- 19,5 mm KB 100/39



HEGAR

KB 110/14

Satz zu 14 Dilatatoren 4,0 mm - 17,0 mm
 Set of 14 dilators 4,0 mm - 17,0 mm
 Juego de 14 dilatadores 4,0 mm - 17,0 mm
 Jeu de 14 dilatateurs 4,0 mm - 17,0 mm
 Serie di 14 dilatatori 4,0 mm - 17,0 mm

KB 110/26

Satz zu 26 Dilatatoren 1,0 mm - 26,0 mm
 Set of 26 dilators 1,0 mm - 26,0 mm
 Juego de 26 dilatadores 1,0 mm - 26,0 mm
 Jeu de 26 dilatateurs 1,0 mm - 26,0 mm
 Serie di 26 dilatatori 1,0 mm - 26,0 mm

KB 112/14

Satz zu 14 Dilatatoren 4,0 mm - 17,0 mm
 Set of 14 dilators 4,0 mm - 17,0 mm
 Juego de 14 dilatadores 4,0 mm - 17,0 mm
 Jeu de 14 dilatateurs 4,0 mm - 17,0 mm
 Serie di 14 dilatatori 4,0 mm - 17,0 mm



HEGAR

Uterus-Dilatatoren
 Uterine Dilators
 Dilataores uterinos
 Dilatateurs du col de l'utérus
 Dilatatori uterini



HEGAR

1,0/ 2,0 mm	KB 113/02
3,0/ 4,0 mm	KB 113/04
5,0/ 6,0 mm	KB 113/06
7,0/ 8,0 mm	KB 113/08
9,0/10,0 mm	KB 113/10
11,0/12,0 mm	KB 113/12
13,0/14,0 mm	KB 113/14
15,0/16,0 mm	KB 113/16
17,0/18,0 mm	KB 113/18
19,0/20,0 mm	KB 113/20
21,0/22,0 mm	KB 113/22
23,0/24,0 mm	KB 113/24
25,0/26,0 mm	KB 113/26

KB 114/08
 Satz zu 8 Dilatatoren 3,0/4,0 mm - 17,0/18,0 mm
 Set of 8 dilators 3,0/4,0 mm - 17,0/18,0 mm
 Juego 8 dilatadores 3,0/4,0 mm - 17,0/18,0 mm
 Jeu de 8 dilatateurs 3,0/4,0 mm - 17,0/18,0 mm
 Serie di 8 dilatatori 3,0/4,0 mm - 17,0/18,0 mm

KB 114/13
 Satz zu 13 Dilatatoren 1,0/2,0 mm - 25,0/26,0 mm
 Set of 13 dilators 1,0/2,0 mm - 25,0/26,0 mm
 Juego de 13 dilatadores 1,0/2,0 mm - 25,0/26,0 mm
 Jeu de 13 dilatateurs 1,0/2,0 mm - 25,0/26,0 mm
 Serie di 13 dilatatori 1,0/2,0 mm - 25,0/26,0 mm



HEGAR

KB 115/08
 Satz zu 8 Dilatatoren 3,0/4,0 mm - 17,0/18,0 mm
 Set of 8 dilators 3,0/4,0 mm - 17,0/18,0 mm
 Juego 8 dilatadores 3,0/4,0 mm - 17,0/18,0 mm
 Jeu de 8 dilatateurs 3,0/4,0 mm - 17,0/18,0 mm
 Serie di 8 dilatatori 3,0/4,0 mm - 17,0/18,0 mm

AA
 AB
 AC
 AD
 AE
 AF
 AK
 AL
 AO
 AP
 AR
KB
 KI
 KC
 KU
 KYE
 X

Uterus-Dilatatoren
Uterine Dilators
Dilatadores uterinos
Dilatateurs du col de l'utérus
Dilatatori uterini



HEGAR

KB 116/08

Satz zu 8 Dilatatoren 3,0/4,0 mm - 17,0/18,0 mm
Set of 8 dilators 3,0/4,0 mm - 17,0/18,0 mm
Juego 8 dilatadores 3,0/4,0 mm - 17,0/18,0 mm
Jeu de 8 dilateurs 3,0/4,0 mm - 17,0/18,0 mm
Serie di 8 dilatatori 3,0/4,0 mm - 17,0/18,0 mm

Uterus-Dilatatoren
 Uterine Dilators
 Dilataores uterinos
 Dilatateurs du col de l'utérus
 Dilattatori uterini



HANK

Fig. 9/10	4,5/ 5,0 mm KB 118/10
Fig. 11/12	5,5/ 6,0 mm KB 118/12
Fig. 13/14	6,5/ 7,0 mm KB 118/14
Fig. 15/16	7,5/ 8,0 mm KB 118/16
Fig. 17/18	8,5/ 9,0 mm KB 118/18
Fig. 19/20	9,5/10,0 mm KB 118/20

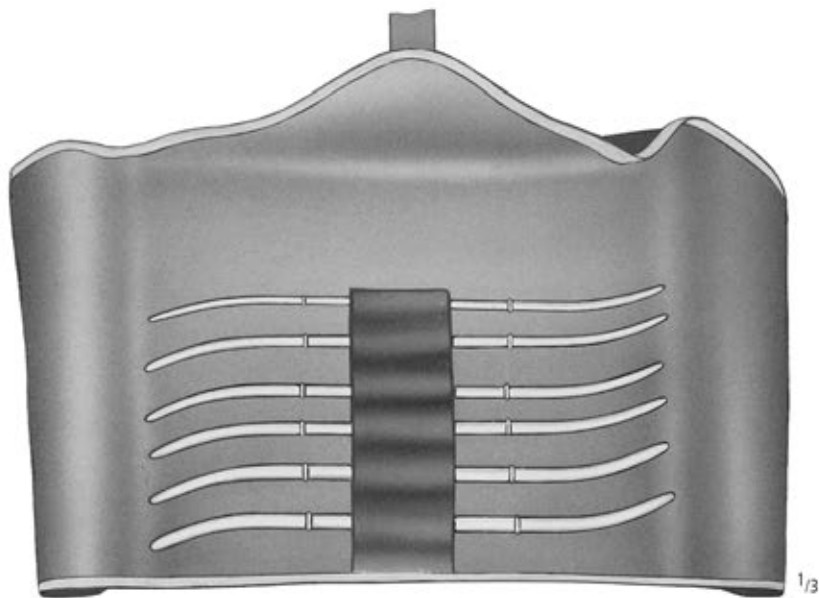

HANK

KB 119/06

Satz zu 6 Dilatatoren 4,5/5,0 mm - 9,5/10,0 mm
 Set of 6 dilators 4,5/5,0 mm - 9,5/10,0 mm
 Juego 6 dilatadores 4,5/5,0 mm - 9,5/10,0 mm
 Jeu de 6 dilatateurs 4,5/5,0 mm - 9,5/10,0 mm
 Serie di 6 dilatatori 4,5/5,0 mm - 9,5/10,0 mm

AA
 AB
 AC
 AD
 AE
 AF
 AK
 AL
 AO
 AP
 AR
KB
 KI
 KC
 KU
 KYE
 X

Uterus-Dilatatoren
 Uterine Dilators
 Dilatadores uterinos
 Dilatateurs du col de l'utérus
 Dilatatori uterini

**PRATT**

Fig. 13/15	4,5/ 5,0 mm KB 120/15
Fig. 17/19	5,6/ 6,3 mm KB 120/19
Fig. 21/23	7,0/ 7,6 mm KB 120/23
Fig. 25/27	8,3/ 9,0 mm KB 120/27
Fig. 29/31	9,6/10,3 mm KB 120/31
Fig. 33/35	11,0/11,6 mm KB 120/35
Fig. 37/39	12,3/13,0 mm KB 120/39
Fig. 41/43	13,6/14,3 mm KB 120/43

**PRATT**

KB 121/08

Satz zu 8 Dilatatoren 4,5/5,0 mm - 13,6/14,3 mm
 Set of 8 dilators 4,5/5,0 mm - 13,6/14,3 mm
 Juego 8 dilatadores 4,5/5,0 mm - 13,6/14,3 mm
 Jeu de 8 dilateurs 4,5/5,0 mm - 13,6/14,3 mm
 Serie di 8 dilatatori 4,5/5,0 mm - 13,6/14,3 mm

Uterus-Dilatatoren
 Uterine Dilators
 Dilataores uterinos
 Dilatateurs du col de l'utérus
 Dilatori uterini

AA

AB

AC

AD

AE

AF

AK

AL

AO

AP

AR

KB

KI

KC

KU

KYE

X

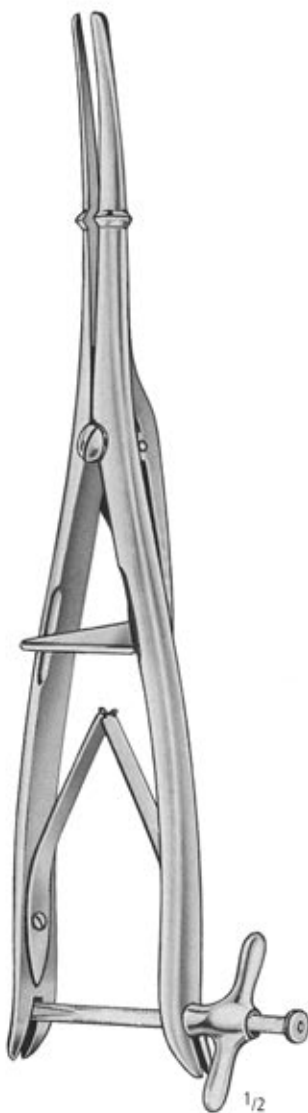

SIMS
 KB 146/29
 29,0 cm/11¹/₂"



GOODELL
 KB 147/34
 34,0 cm/13¹/₂"

Uterussonden
 Uterine Sounds
 Histerómetros
 Hystéromètres
 Isterometri



SIMS

KB 200/32
 32,0 cm/12 1/2"

KB 201/32
 32,0 cm/12 1/2"

SIMS-SPECIAL

KB 202/32
 32,0 cm/12 1/2"

SIMS

schwed. Modell
 KB 203/26
 26,0 cm/10 1/4"

MARTIN

KB 204/30
 30,0 cm/12"

VALLEIX

KB 210/25
 25,0 cm/10"

fest
 rigid
 rigida
 rigide
 rigido

biegsam
 malleable
 maleable
 malléable
 malleabile

Uterusdepressoren
 Uterine Depressors
 Depressores uterinos
 Dépresseurs utérins
 Depressori uterini

AA
 AB
 AC
 AD
 AE
 AF
 AK
 AL
 AO
 AP
 AR
KB
 KI
 KC
 KU
 KYE
 X



BRAUN
 KB 215/28
 28,0 cm/11"



SIMS
 KB 217/26
 26,0 cm/10¹/₄"

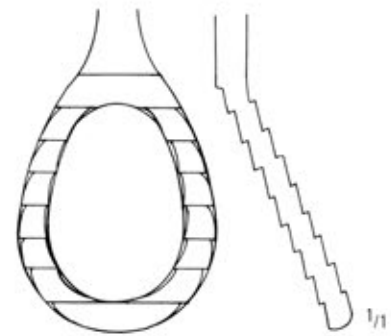
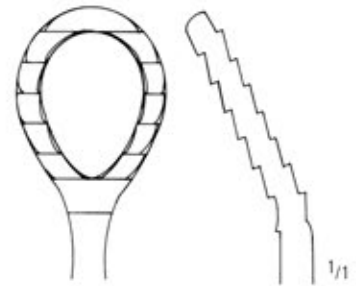

Hakenzangen
 Tenaculum Forceps
 Pinzas para coger el cuello del útero
 Pincès pour abaissement du col de l'utérus
 Pinze per abbassare il collo del l'utero



POZZI
 KB 250/25
 25,0 cm/10"



BRAUN
 KB 252/25
 25,0 cm/10"



WILSON
 KB 253/25
 24,0 cm/9 1/2"



SKENE
 KB 254/24
 24,0 cm/9 1/2"



SCHRÖDER
 KB 255/25
 25,0 cm/10"



BARRETT
 KB 256/18
 18,0 cm/7"



SAIRGES
 KB 257/23
 23,0 cm/9"



DUPLAY
 KB 259/28
 28,0 cm/11"

GYNÄKOLOGIE GYNECOLOGY GINECOLOGIA GYNECOLOGIE GINECOLOGIA

Hakenzangen
 Tenaculum Forceps
 Pinzas para coger el cuello del útero
 Pincettes pour abaissement du col de l'utérus
 Pinze per abbassare il collo dell'utero

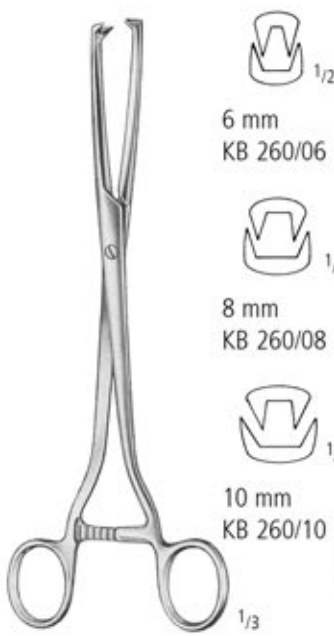

MUSEUX
24,0 cm/9¹/₂"

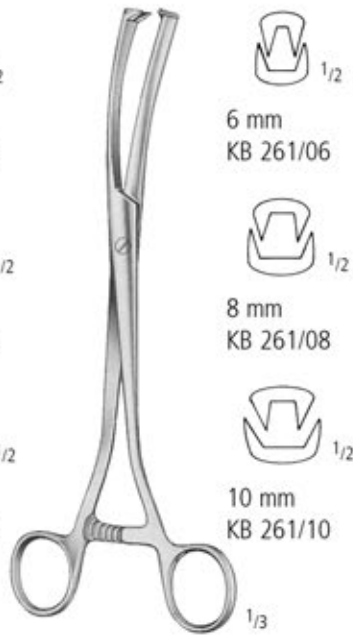

MUSEUX
24,0 cm/9¹/₂"

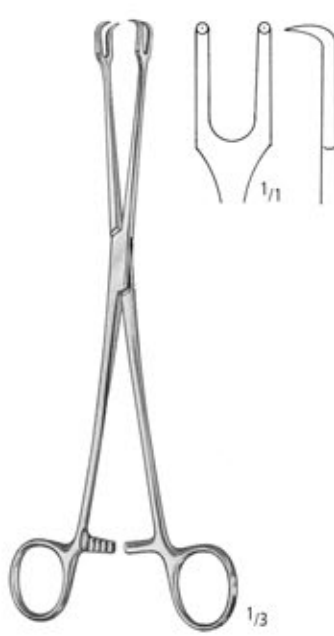

SCHRÖDER
KB 262/24
24,0 cm/9¹/₂"



SCHRÖDER
KB 263/24
24,0 cm/9¹/₂"

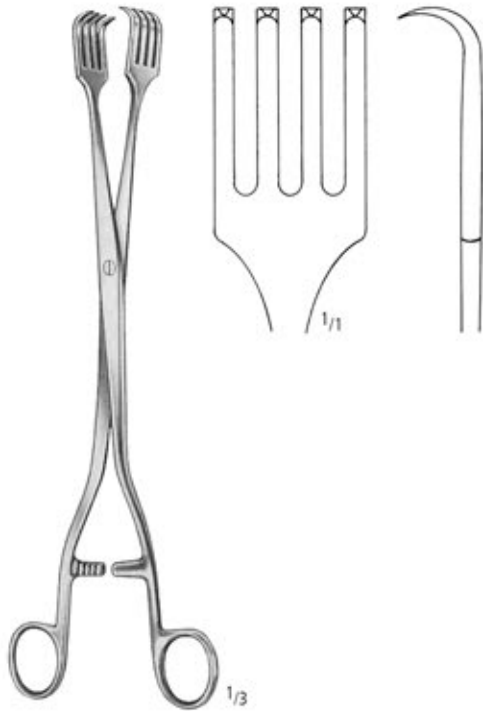

PRATT
KB 265/28
28,0 cm/11"



JACOBS
KB 266/21
21,0 cm/8¹/₄"



JACOBS
KB 267/21
21,0 cm/8¹/₄"

AA
AB
AC
AD
AE
AF
AK
AL
AO
AP
AR
KB
KI
KC
KU
KYE
X

Hakenzangen
Tenaculum Forceps
Pinzas para coger el cuello del útero
Pinces pour abaissement du col de l'utérus
Pinze per abbassare il collo del l'utero



HENROTIN
KB 268/20
20,5 cm/8"



TEALE
KB 269/23
23,0 cm/9"

Myom-Instrumente, Myom-Messer
 Myoma Instruments, Myoma Knife
 Instrumentos para fibroma, Cuchillo de mioma
 Instruments pour fibrome, Lame de myome
 Strumenti per fibromi, Coltello di mioma



DOYEN
 KB 270/17
 17,0 cm/6³/₄"



DOYEN
 KB 272/17
 17,0 cm/6³/₄"

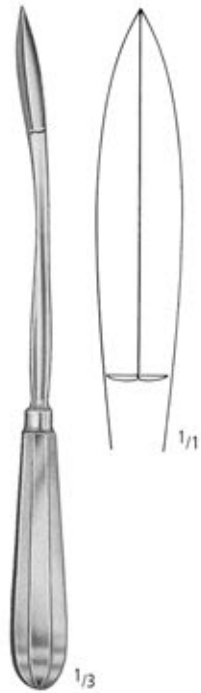

SEGOND
 KB 275/27
 27,0 cm/10¹/₂"

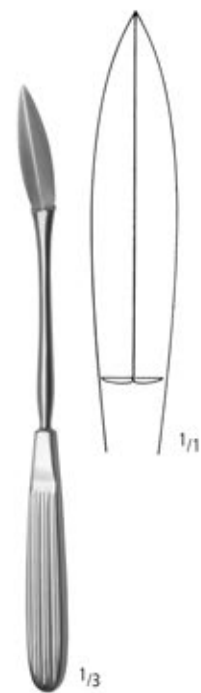
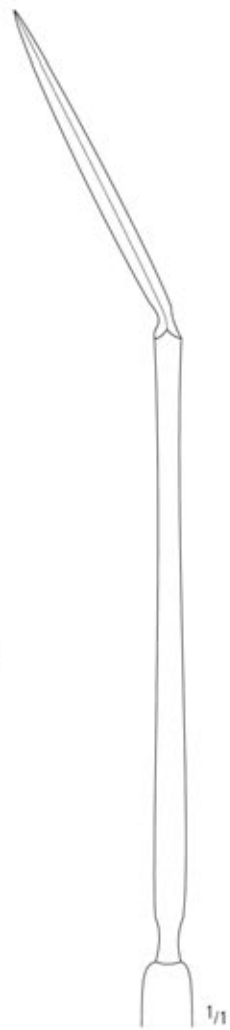

AYRE
 KB 277/23
 23,5 cm/9¹/₃"

AA
 AB
 AC
 AD
 AE
 AF
 AK
 AL
 AO
 AP
 AR
KB
 KI
 KC
 KU
 KYE
 X

Myom-Instrumente, Uterus-Fasszangen
 Myoma Instruments, Uterine Elevating Forceps
 Instrumentos para fibroma, Pinzas para el útero
 Instruments pour fibrome, Pincés hystérolabes
 Strumenti per fibromi, Pinze per afferrare l'utero



DARTIGUES
 KB 280/27
 27,0 cm/10¹/₂"



SOMER
 KB 283/23
 23,0 cm/9"

Polypenzangen in Gruppe AF
 For polypus forceps see section AF
 Para pinzas polipos vea la sección AF
 Pour pincés à polypes voir la section AF
 Per le pinze per polipi, consultare la sezione AF

Fistelhaken
 Fistula Hooks
 Ganchos para fistulas
 Crochets pour fistules
 Uncini per fistola

AA
 AB
 AC
 AD
 AE
 AF
 AK
 AL
 AO
 AP
 AR
KB
 KI
 KC
 KU
 KYE
 X



EMMET
 22,0 cm/8³/₄"

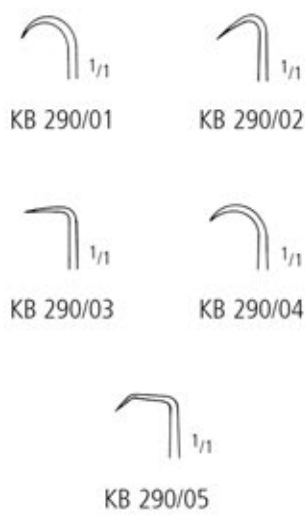

SIMON
 KB 292/01
 22,0 cm/8³/₄"



SIMON
 KB 292/02
 22,0 cm/8³/₄"

Weitere Haken in Gruppe AK
 For further hooks see section AK
 Para otras ganchos vea la sección AK
 Pour d'autres crochets voir la section AK
 Per altri tipi di divaricatori, consultare la sezione AK

Saug- und Biopsieküretten
 Suction Biopsy Curettes
 Curetas aspiradoras para biopsia
 Curettes à aspiration pour biopsie
 Curette d'aspirazione per biopsia



RANDALL
 KB 300/04
 24,0 cm/9 1/2"



NOVAK
 23,0 cm/9"
 Ø 2,0 mm KB 302/02
 Ø 3,0 mm KB 302/03



NOVAK
 KB 302/04
 23,0 cm/9"



NOVAK-SCHOECKAERT
 KB 302/14
 24,0 cm/9 1/2"



KEVORKIAN
 KB 304/30
 30,0 cm/12"



KEVORKIAN
 KB 305/30
 30,0 cm/12"

Biopsie- und Absaugküretten
 Biopsy and Aspirating Curettes
 Curetas para biopsia y de aspiración
 Curettes pour biopsie et d'aspiration
 Curette per biopsia et per aspirazione

AA

AB

AC

AD

AE

AF

AK

AL

AO

AP

AR

KB

KI

KC

KU

KYE

X

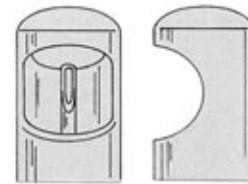

MILAN
28,0 cm/11"



4,0 mm
KB 308/04



6,0 mm
KB 308/06



9,0 mm
KB 308/09



KB 310/00



- | | |
|-----------|-----------|
| Ø 3,0 mm | KB 310/03 |
| Ø 4,5 mm | KB 310/04 |
| Ø 6,0 mm | KB 310/06 |
| Ø 8,0 mm | KB 310/08 |
| Ø 10,0 mm | KB 310/10 |
| Ø 12,0 mm | KB 310/12 |
| Ø 14,0 mm | KB 310/14 |

Uterus-Biopsiezangen
 Cervical Biopsy Forceps
 Pinzas saca bocados para biopsia
 Pincas emporte-pièces à biopsie
 Pinze taglianti per biopsia

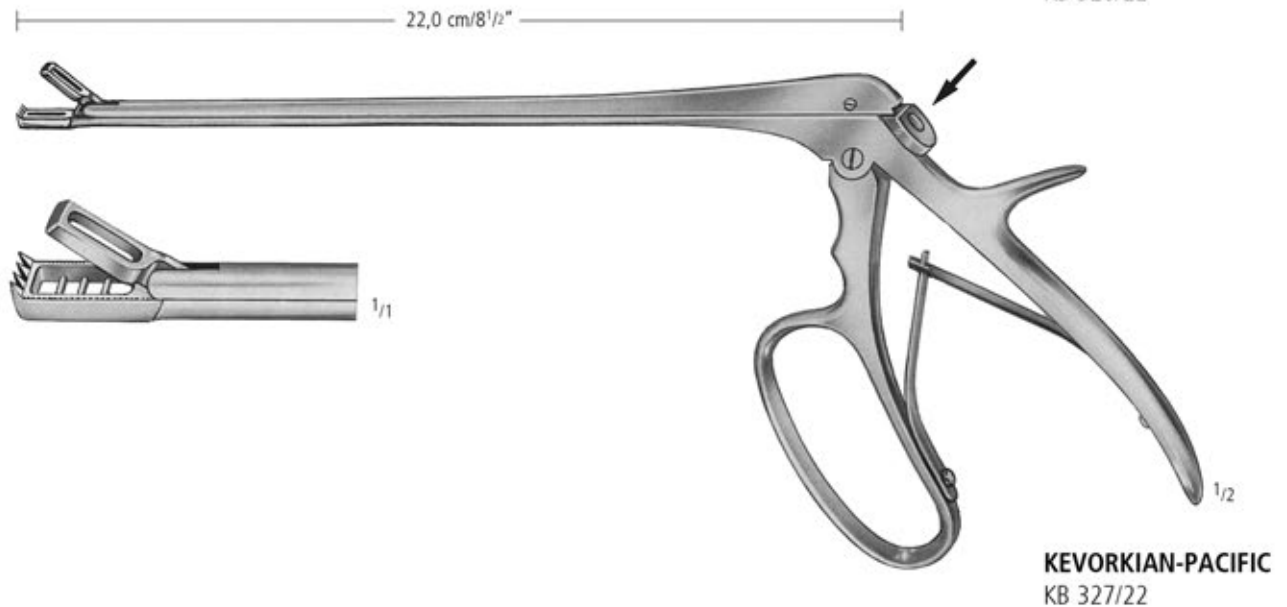
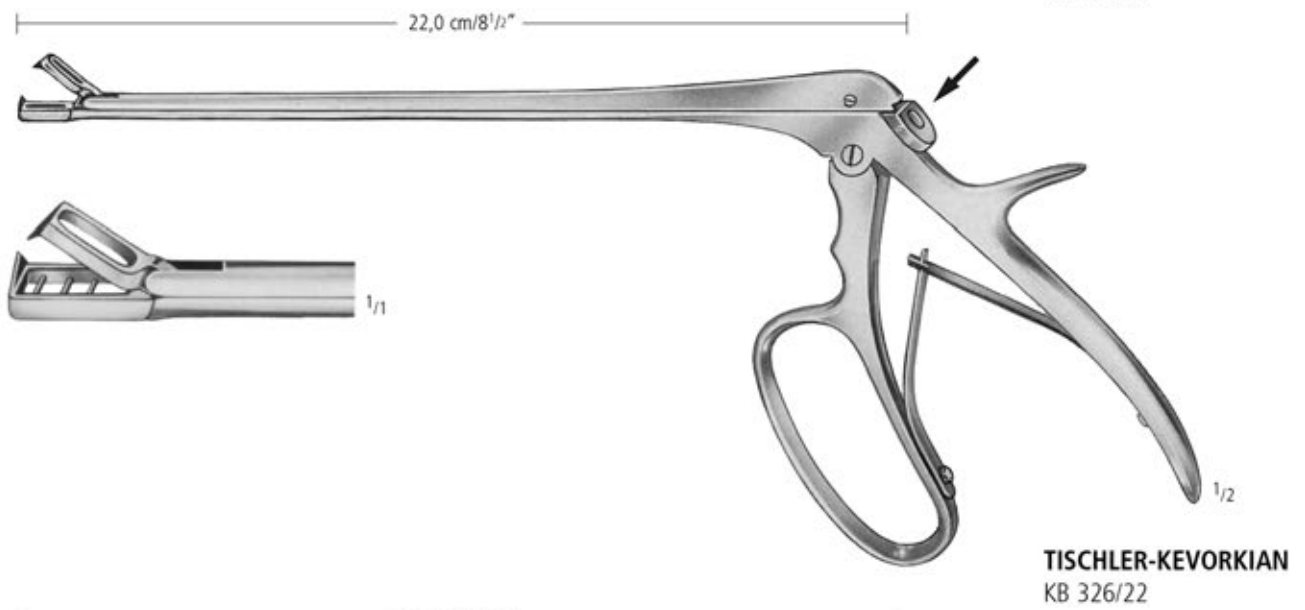
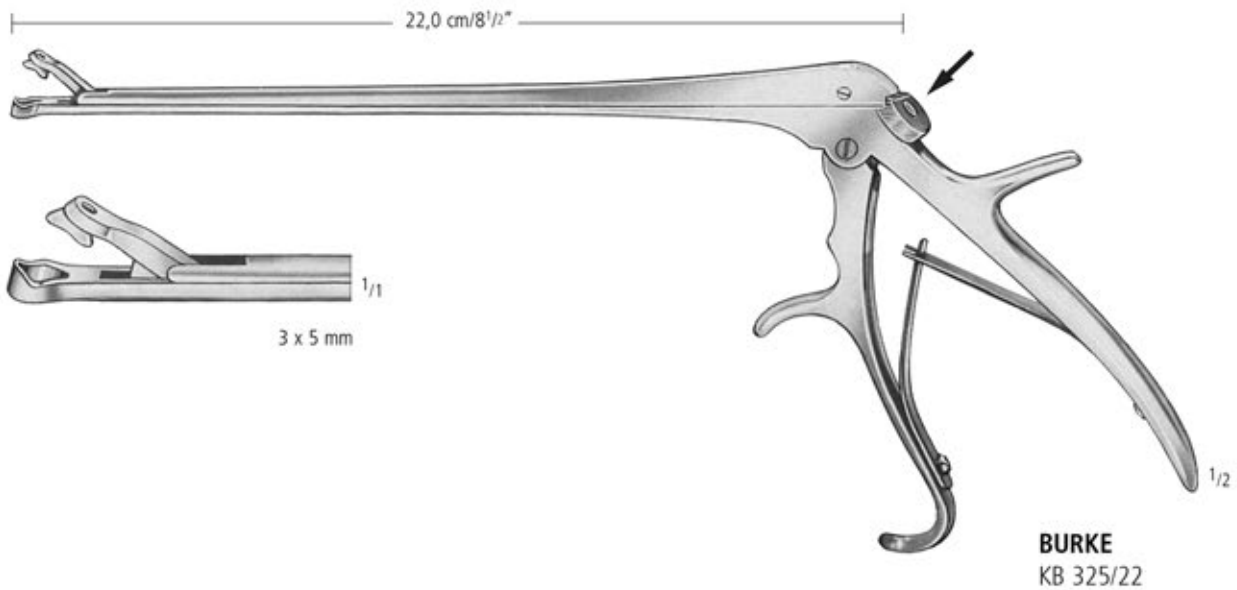

Uterus-Biopsiezangen
 Cervical Biopsy Forceps
 Pinzas saca bocados para biopsia
 Pincas emporte-pièces à biopsie
 Pinze taglienti per biopsia

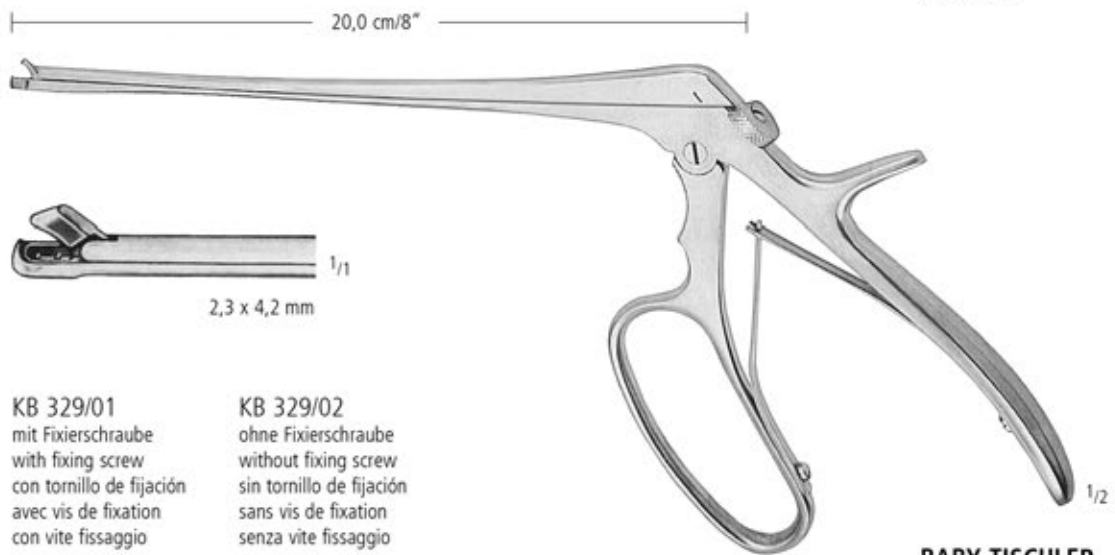
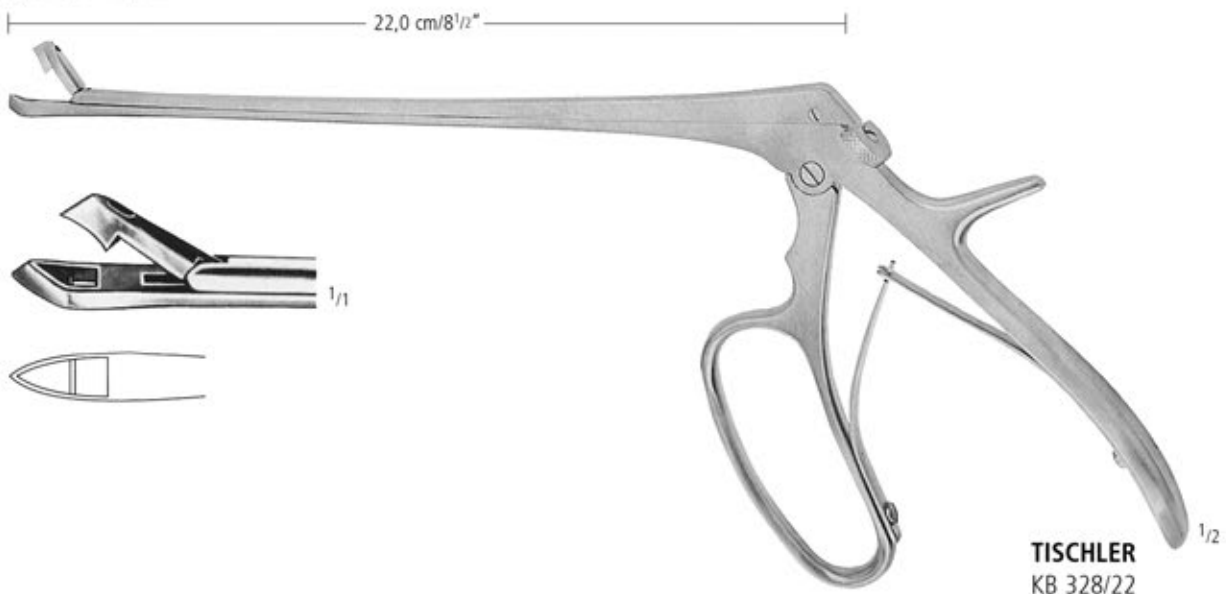

KB 329/01
 mit Fixierschraube
 with fixing screw
 con tornillo de fijación
 avec vis de fixation
 con vite fissaggio

KB 329/02
 ohne Fixierschraube
 without fixing screw
 sin tornillo de fijación
 sans vis de fixation
 senza vite fissaggio

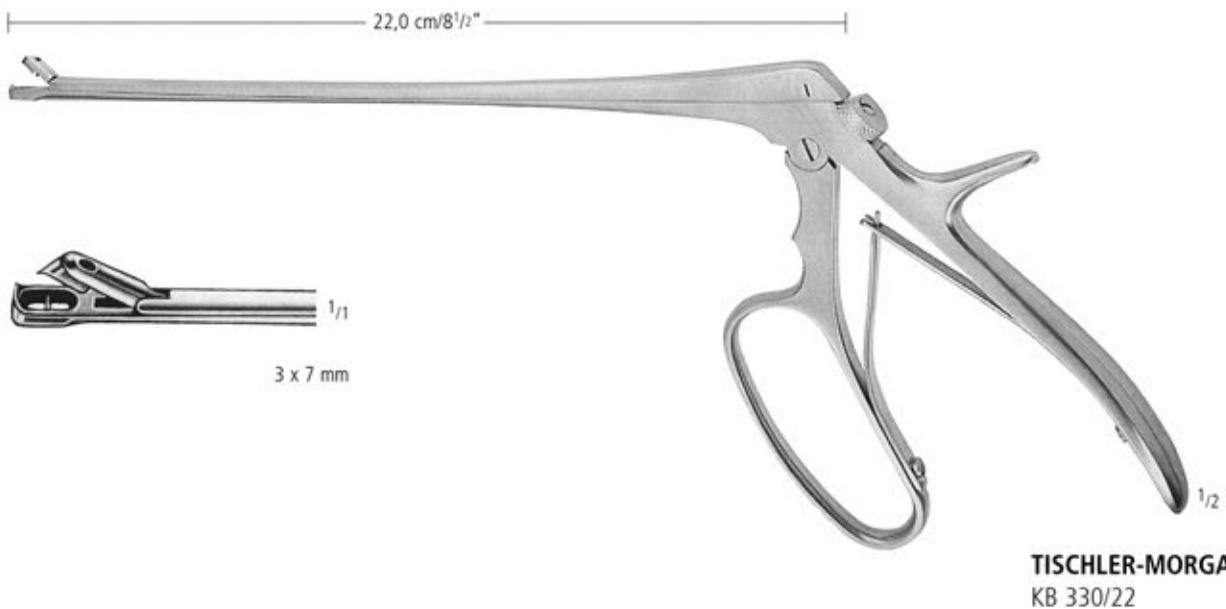

AA
 AB
 AC
 AD
 AE
 AF
 AK
 AL
 AO
 AP
 AR
KB
 KI
 KC
 KU
 KYE
 X

Uterus-Biopsiezangen
 Cervical Biopsy Forceps
 Pinzas saca bocados para biopsia
 Pincers emporte-pièces à biopsie
 Pinze taglianti per biopsia



GELLHORN
 KB 331/23
 23,0 cm/9"



FAURE
 KB 333/23
 23,0 cm/9"



SCHUBERT
 KB 334/21 KB 334/29
 21,0 cm/8 1/2" 29,0 cm/11 1/2"

Uterus-Biopsiezangen
 Cervical Biopsy Forceps
 Pinzas saca bocados para biopsia
 Pincas emporte-pièces à biopsie
 Pinze taglienti per biopsia

AA
 AB
 AC
 AD
 AE
 AF
 AK
 AL
 AO
 AP
 AR
KB
 KI
 KC
 KU
 KYE
 X



THOMS-GAYLOR
 KB 335/24
 24,0 cm/9¹/₂"



SCHUBERT
 KB 337/26
 26,0 cm/10¹/₂"



TISCHLER
 KB 338/27
 27,0 cm/10³/₄"

Uterus-Biopsiezangen
 Cervical Biopsy Forceps
 Pinzas saca bocados para biopsia
 Pincas emporte-pièces à biopsie
 Pinze taglianti per biopsia

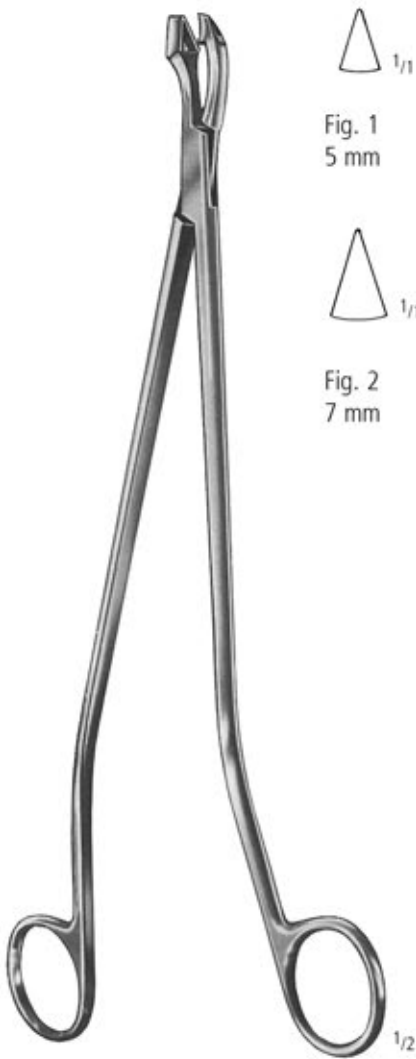

SCHUMACHER-VAN DOREN
 KB 339/24 KB 340/24
 Fig. 1 Fig. 2
 24,0 cm/9 1/2"



VAN DOREN
 KB 341/25
 25,0 cm/10"



VAN DOREN
 KB 342/25
 25,0 cm/10"

Uterus-Biopsiezangen
 Cervical Biopsy Forceps
 Pinzas saca bocados para biopsia
 Pincas emporte-pièces à biopsie
 Pinze taglienti per biopsia

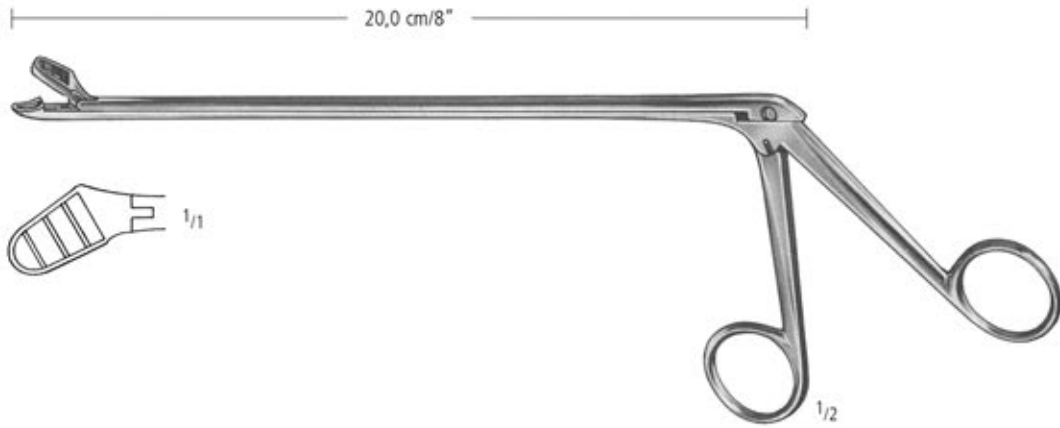

ALEXANDER
 KB 343/28

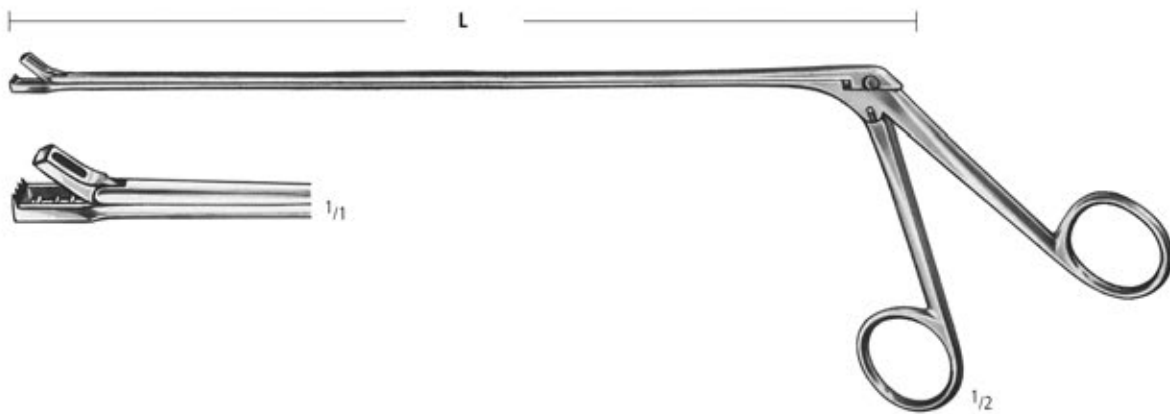

KEVORKIAN
 L = 23,0 cm / 9" KB 345/23
 L = 25,0 cm / 10" KB 345/25

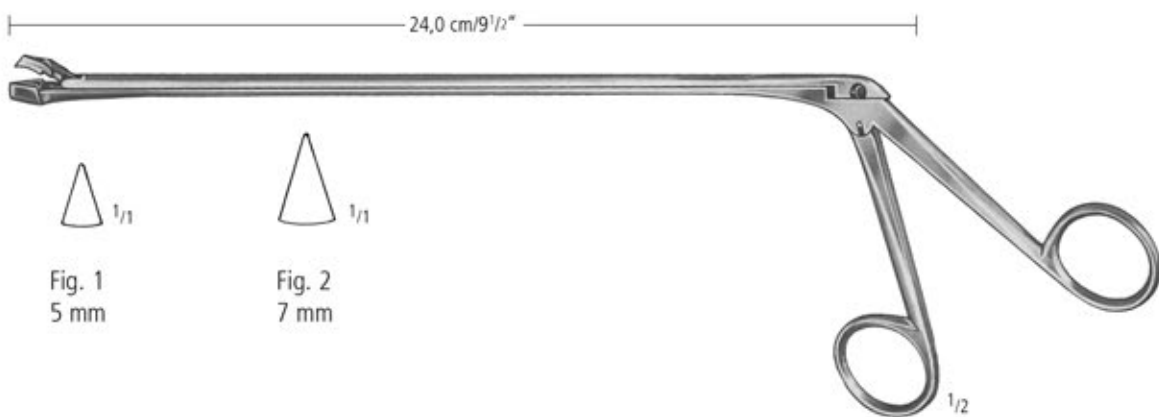

SCHUMACHER
 KB 347/05 5 mm
 KB 347/07 7 mm

AA
 AB
 AC
 AD
 AE
 AF
 AK
 AL
 AO
 AP
 AR
 KB
 KI
 KC
 KU
 KYE
 X

Uterus-Biopsiezangen
 Cervical Biopsy Forceps
 Pinzas saca bocados para biopsia
 Pincas emporte-pièces à biopsie
 Pinze taglianti per biopsia

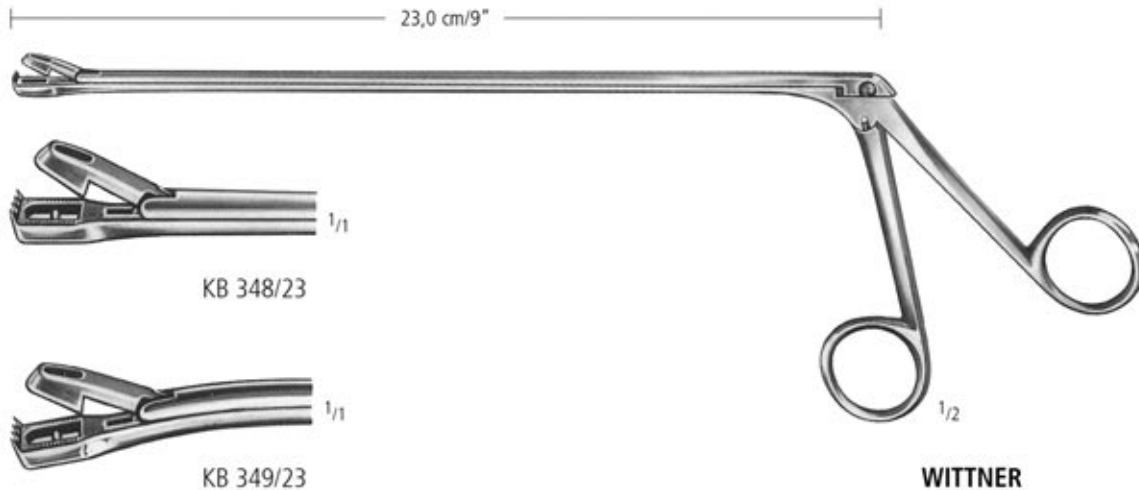

KB 348/23

KB 349/23

WITTNER

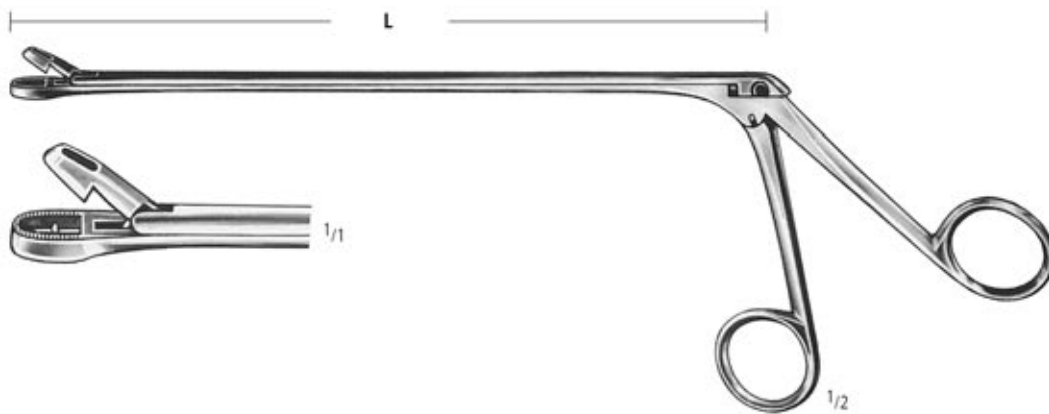

EPPENDORF
 L = 20,0 cm/8" KB 350/20
 L = 23,0 cm/9" KB 350/23

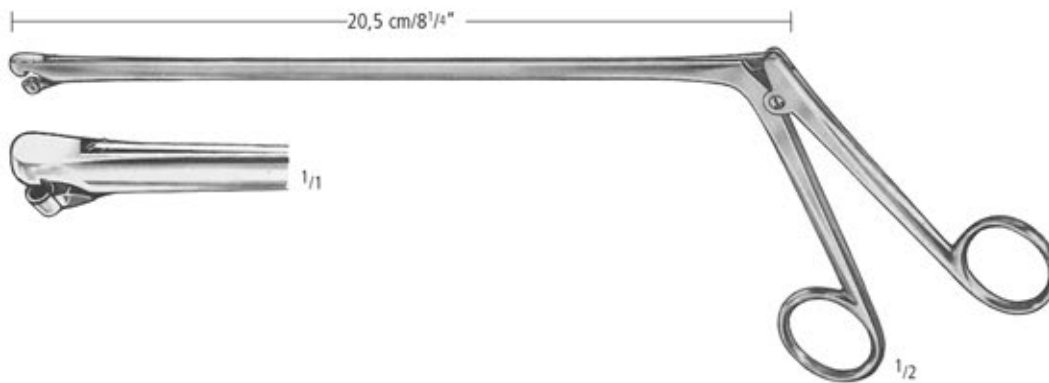

BERGER
 KB 352/20

Uterus-Biopsiezangen
 Cervical Biopsy Forceps
 Pinzas saca bocados para biopsia
 Pincas emporte-pièces à biopsie
 Pinze taglianti per biopsia

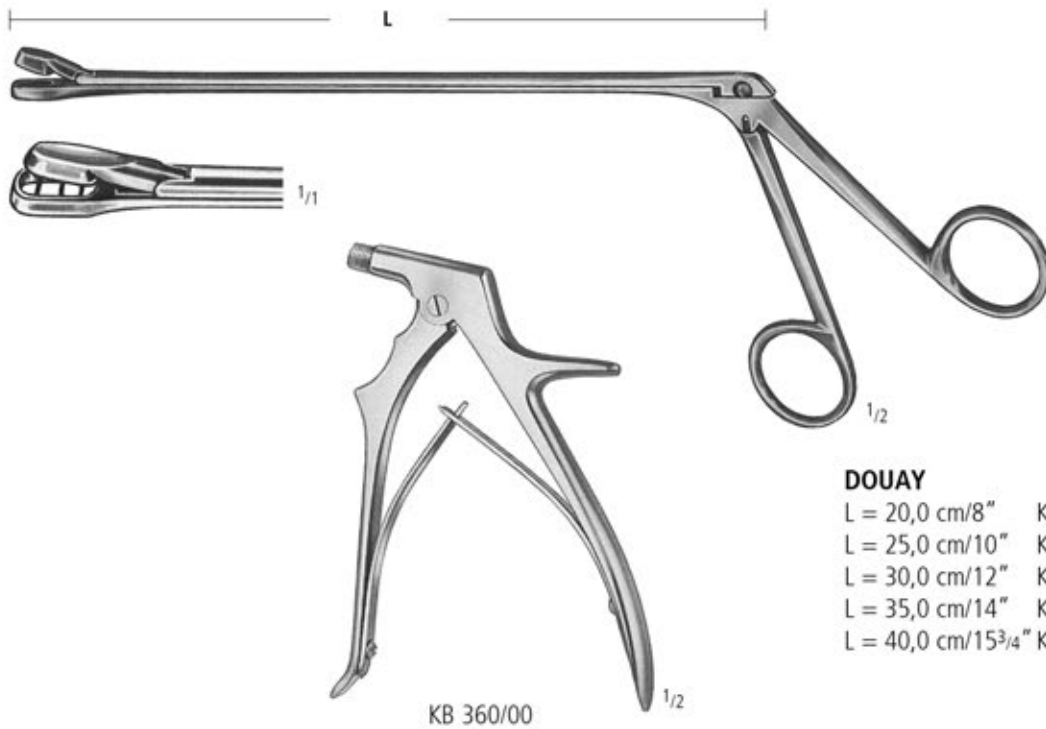

DOUAY

- L = 20,0 cm/8" KB 356/20
- L = 25,0 cm/10" KB 356/25
- L = 30,0 cm/12" KB 356/30
- L = 35,0 cm/14" KB 356/35
- L = 40,0 cm/15³/₄" KB 356/40

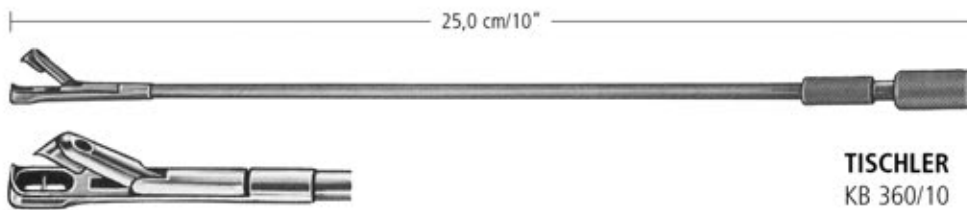

TISCHLER
KB 360/10

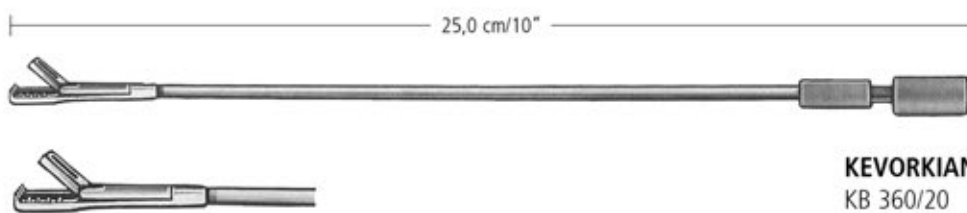

KEVORKIAN
KB 360/20

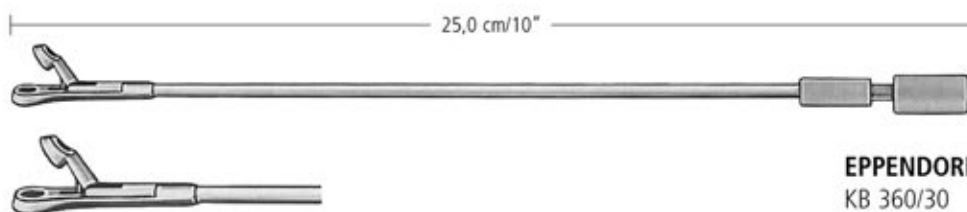

EPPENDORF
KB 360/30

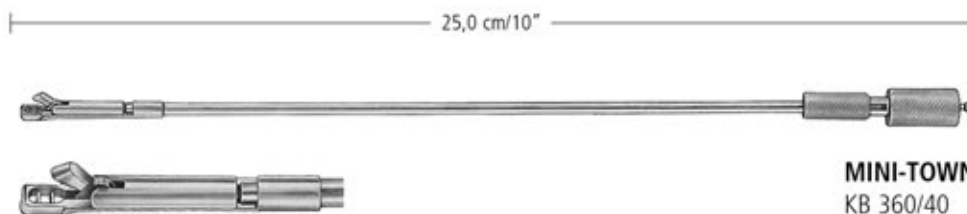

MINI-TOWNSEND
KB 360/40

AA
AB
AC
AD
AE
AF
AK
AL
AO
AP
AR
KB
KI
KC
KU
KYE
X

Instrumentarium zur Hysterosalpingographie
Instrumentation for Hystero-Salpingography
Instrumental para histero-salpingografía
Instrumentation pour hystéro-salpingographie
Strumentario per isterosalpingografia

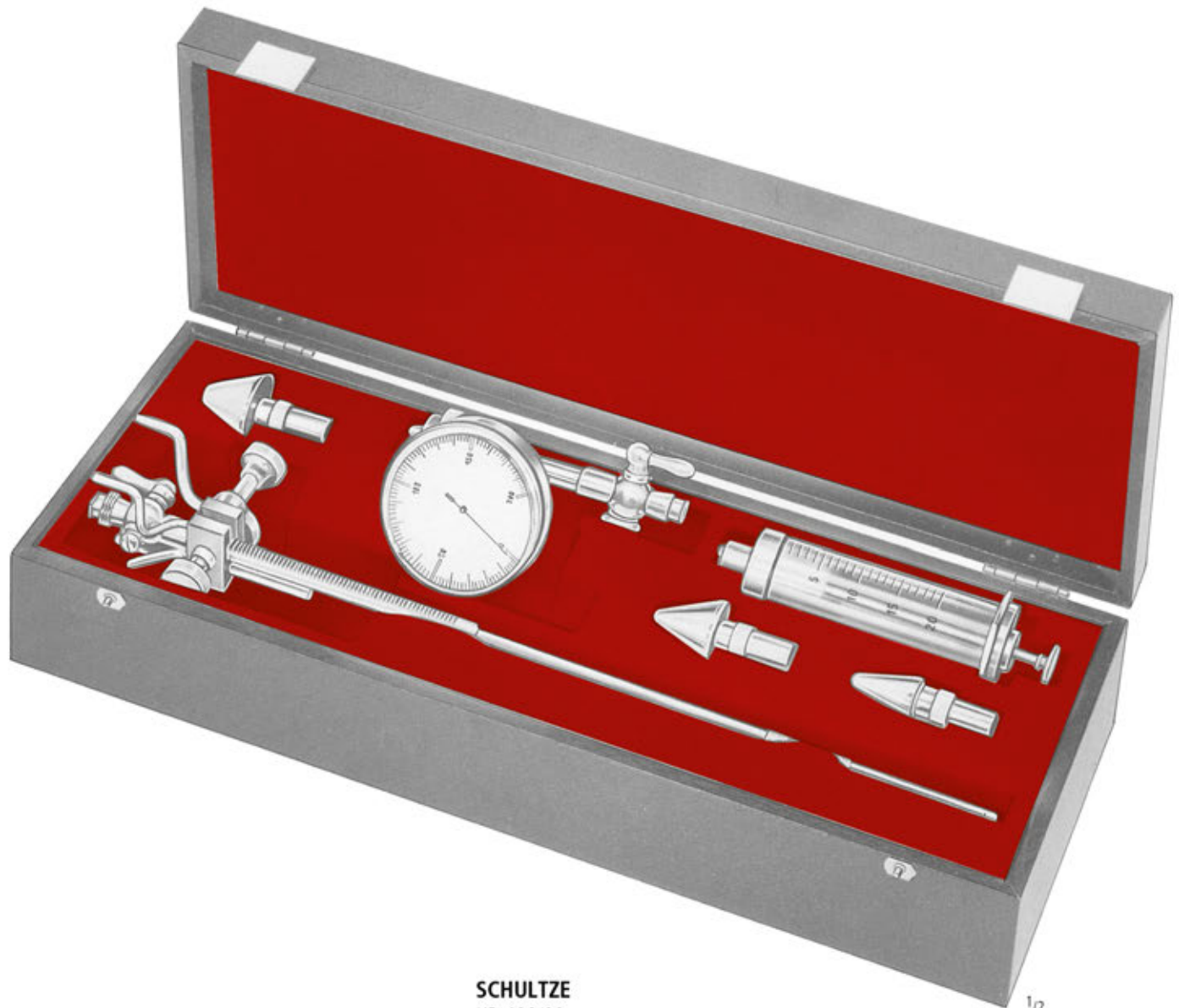

SCHULTZE
KB 400/00

komplett
complete
completo
complet
completo

Hysteroskopie
 Hysteroscopy
 Histeroscopia
 Hysteroscopie
 Isteroscopia

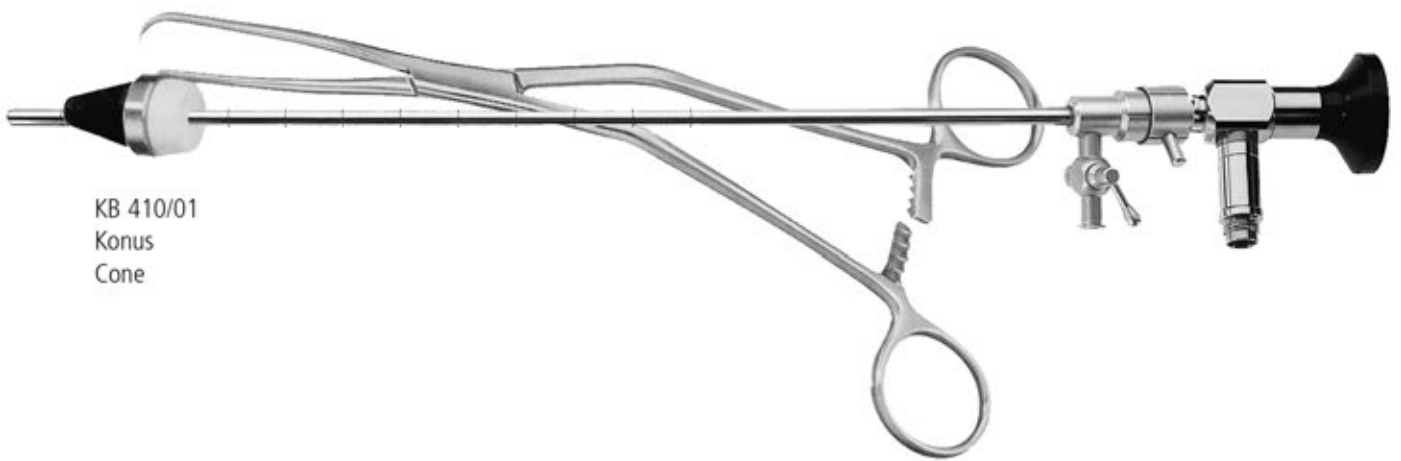

KB 410/01
 Konus
 Cone

KB 410/00
 Zange + Konus
 Forceps + Cone

AA

AB

AC

AD

AE

AF

AK

AL

AO

AP

AR

KB

KI

KC

KU

KYE

X

Endoskopie, Pelviskopie
 Endoscopy, Pelviscopy
 Endoscopia, Pelviscopio
 Endoscopie, Pelviscopie
 Endoscopia, Pelviscopia



COHEN
 KB 430/00

mit zwei Aufsätzen
 with two cones



KB 430/01



KB 430/02



KB 440/00

komplett
 complete
 completo
 completo
 complet
 completo



KB 440/01



KB 440/02

Uterusküretten
 Uterine Curettes
 Curetas uterinas
 Curettes utérines
 Curette uterine

scharf
 sharp
 cortante
 tranchante
 taglienti

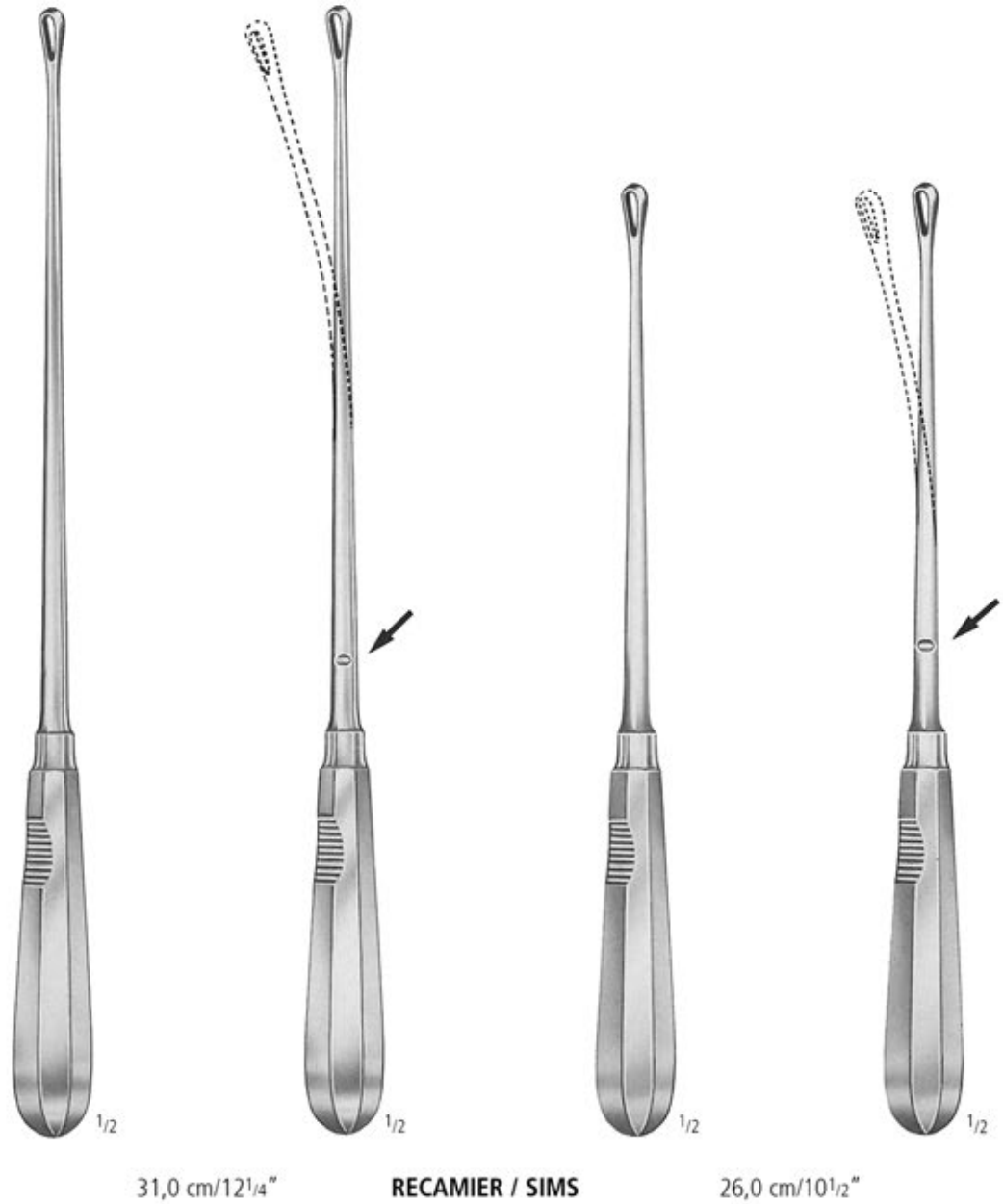
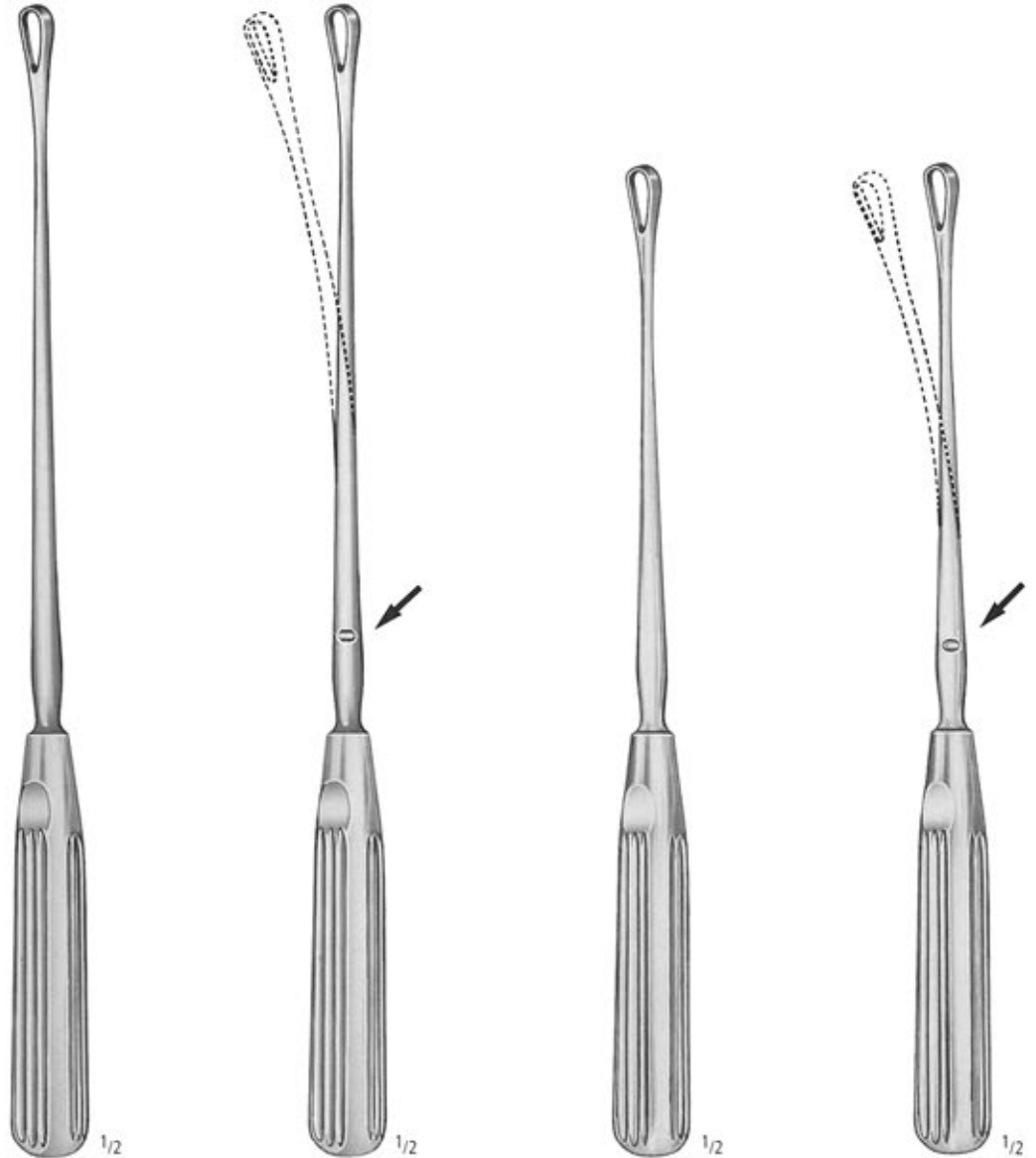

Fig. 00	5,0 mm	KB 499/00	KB 509/00	KB 519/00	KB 529/00
Fig. 0	6,0 mm	KB 500/00	KB 510/00	KB 520/00	KB 530/00
Fig. 1	7,0 mm	KB 500/01	KB 510/01	KB 520/01	KB 530/01
Fig. 2	8,0 mm	KB 500/02	KB 510/02	KB 520/02	KB 530/02
Fig. 3	9,0 mm	KB 500/03	KB 510/03	KB 520/03	KB 530/03
Fig. 4	11,0 mm	KB 500/04	KB 510/04	KB 520/04	KB 530/04
Fig. 5	12,0 mm	KB 500/05	KB 510/05	KB 520/05	KB 530/05
Fig. 6	14,0 mm	KB 500/06	KB 510/06	KB 520/06	KB 530/06
Fig. 7	15,0 mm	KB 500/07	KB 510/07	KB 520/07	KB 530/07
Fig. 8	16,0 mm	KB 500/08	KB 510/08	KB 520/08	KB 530/08
Fig. 9	19,0 mm	KB 500/09	KB 510/09	KB 520/09	KB 530/09
Fig. 10	20,0 mm	KB 500/10	KB 510/10	KB 520/10	KB 530/10
Fig. 11	21,0 mm	KB 500/11	KB 510/11	KB 520/11	KB 530/11
Fig. 12	23,0 mm	KB 500/12	KB 510/12	KB 520/12	KB 530/12

AA
 AB
 AC
 AD
 AE
 AF
 AK
 AL
 AO
 AP
 AR
KB
 KI
 KC
 KU
 KYE
 X

Uterusküretten
 Uterine Curettes
 Curetas uterinas
 Curettes utérines
 Curette uterine

stumpf
 blunt
 romo
 mousse
 smusse



31,0 cm/12¹/₄"

RECAMIER / SIMS

26,0 cm/10¹/₂"

Fig. 00	5,0 mm	KB 549/00	KB 559/00	KB 569/00	KB 579/00
Fig. 0	6,0 mm	KB 550/00	KB 560/00	KB 570/00	KB 580/00
Fig. 1	7,0 mm	KB 550/01	KB 560/01	KB 570/01	KB 580/01
Fig. 2	8,0 mm	KB 550/02	KB 560/02	KB 570/02	KB 580/02
Fig. 3	9,0 mm	KB 550/03	KB 560/03	KB 570/03	KB 580/03
Fig. 4	11,0 mm	KB 550/04	KB 560/04	KB 570/04	KB 580/04
Fig. 5	12,0 mm	KB 550/05	KB 560/05	KB 570/05	KB 580/05
Fig. 6	14,0 mm	KB 550/06	KB 560/06	KB 570/06	KB 580/06
Fig. 7	15,0 mm	KB 550/07	KB 560/07	KB 570/07	KB 580/07
Fig. 8	16,0 mm	KB 550/08	KB 560/08	KB 570/08	KB 580/08
Fig. 9	19,0 mm	KB 550/09	KB 560/09	KB 570/09	KB 580/09
Fig. 10	20,0 mm	KB 550/10	KB 560/10	KB 570/10	KB 580/10
Fig. 11	21,0 mm	KB 550/11	KB 560/11	KB 570/11	KB 580/11
Fig. 12	23,0 mm	KB 550/12	KB 560/12	KB 570/12	KB 580/12

Uterusküretten
Uterine Curettes
Curetas uterinas
Curettes utérines
Curette uterine



starr/scharf			
rigid/sharp	KB 582/11	KB 582/12	KB 582/13
starr/stumpf			
rigid/blunt	KB 583/11	KB 583/12	KB 583/13
biegsam/scharf			
malleable/sharp	KB 584/11	KB 584/12	KB 584/13
biegsam/stumpf			
malleable/blunt	KB 585/11	KB 585/12	KB 585/13



BUMM
32,0 cm/12³/₄" -
34,0 cm/13¹/₂"

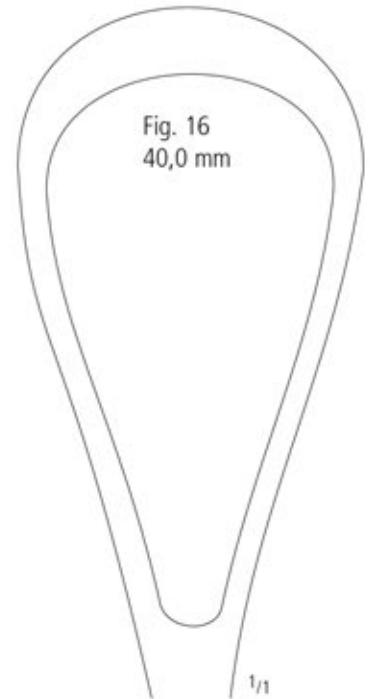

starr/scharf			
rigid/sharp	KB 582/14	KB 582/15	KB 582/16
starr/stumpf			
rigid/blunt	KB 583/14	KB 583/15	KB 583/16
biegsam/scharf			
malleable/sharp	KB 584/14	KB 584/15	KB 584/16
biegsam/stumpf			
malleable/blunt	KB 585/14	KB 585/15	KB 585/16

AA
AB
AC
AD
AE
AF
AK
AL
AO
AP
AR
KB
KI
KC
KU
KYE
X

Uterusküretten
 Uterine Curettes
 Curetas uterinas
 Curettes utérines
 Curette uterine



COLLIN
 28,0 cm/11"

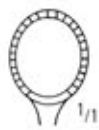

8,0 mm
 KB 590/08

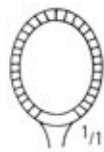

10,0 mm
 KB 590/10



12,0 mm
 KB 590/12



14,0 mm
 KB 590/14



BLAKE
 KB 592/27
 27,0 cm/10 1/2"



scharf
 sharp
 cortante
 tranchante
 taglienti



stumpf
 blunt
 romo
 mousse
 smusse

Uteruslöffel
 Uterine Scoops
 Cucharillas y curetas uterinas
 Curettes utérines
 Curette uterine

AA
 AB
 AC
 AD
 AE
 AF
 AK
 AL
 AO
 AP
 AR
KB
 KI
 KC
 KU
 KYE
 X



25,0 cm/10"
 30,0 cm/12"



Fig. 1
 KB 594/01
 KB 595/01



Fig. 2
 KB 594/02
 KB 595/02



Fig. 3
 KB 594/03
 KB 595/03



Fig. 4
 KB 594/04
 KB 595/04

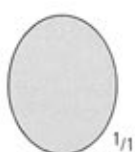

25,0 cm/10"
 30,0 cm/12"

Fig. 5
 KB 594/05
 KB 595/05

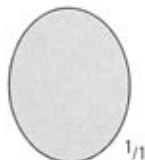

Fig. 6
 KB 594/06
 KB 595/06

SIMON / SCHRÖDER



GOURDET
 28,0 cm/11"



Fig. 1
 KB 596/01



Fig. 2
 KB 596/02



Fig. 3
 KB 596/03

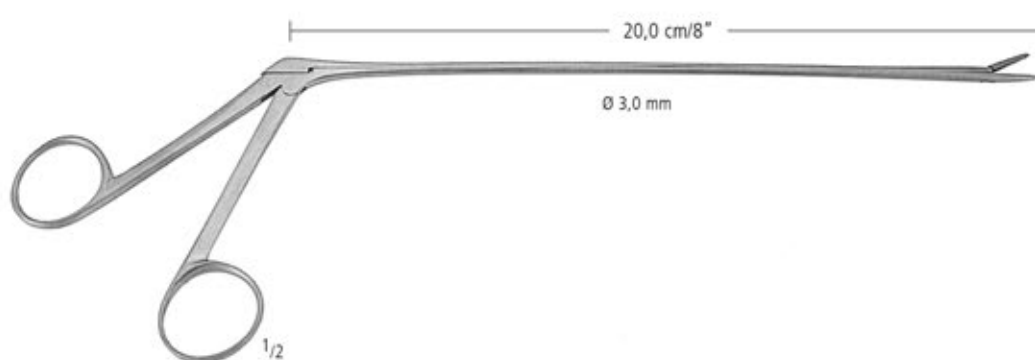

Fig. 4
 KB 596/04



Fig. 5
 KB 596/05

Instrumente für die Entfernung von Spiralen
Instruments for Removal of I.U.D.
Instrumentos para remover dispositivo intrauterino
Instruments pour retirer le stérilet
Strumenti per la rimozione dello I.U.D.



KB 598/20



SAUNDERS
KB 599/31
31,0 cm/12¹/₄"

Instrumente für Mini-Laparotomie
 Instruments for Mini-Laparotomy
 Instrumentas para Mini-Laparotomia
 Instruments pour la Mini-Laparotomie
 Strumenti per Mini-Laparotomia



Uterus-Manipulator
 Uterine manipulator

RAMATHIBODI
 KB 630/27
 27,5 cm/10³/₄"



Tuben-Haken
 Tubal hook

RAMATHIBODI
 KB 631/25
 25 cm/10"

AA
 AB
 AC
 AD
 AE
 AF
 AK
 AL
 AO
 AP
 AR
KB
 KI
 KC
 KU
 KYE
 X

GEBURTSHILFE
OBSTETRICS
OBSTETRICIA
OBSTÉTRIQUE
OSTETRICIA

KB

nopa[®] instruments



Beckenzirkel, Geburtszangen
 Pelvimeters, Obstetrical Forceps
 Pelvimetros, Forceps obstétrico
 Compas pelvimètre, Forceps obstétriques
 Pelvimetri, Pinza ostetrica



MARTIN
 KB 700/34
 34,0 cm/13¹/₃"



NAEGELE
 KB 730/36 KB 730/40
 36,0 cm/14" 40,0 cm/15³/₄"



SIMPSON
 KB 732/23
 23,0 cm/9"



SIMPSON
 KB 734/30
 30,0 cm/12"

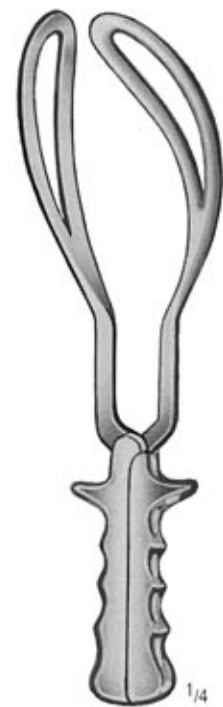

SIMPSON-BRAUN
 KB 736/36
 36,0 cm/14"

Geburtszangen
Obstetrical Forceps
Forceps obstétrico
Forceps obstétriques
Pinza ostetrica

AA
AB
AC
AD
AE
AF
AK
AL
AO
AP
AR
KB
KI
KC
KU
KYE
X



McLEAN
KB 744/36
36,0 cm/14"



KIELLAND
KB 752/41
41,0 cm/16"



KIELLAND-LUIKART
KB 754/40
40,0 cm/15³/₄"



WRIGLEY
KB 756/28
28,0 cm/11"



DE LEE
KB 758/30
30,0 cm/12"



PIPER
KB 760/44
44,0 cm/17¹/₃"

Plazentar- und Abortuszangen
 Placenta and Ovum Forceps
 Pinzas para aborto y placenta
 Pincas à faux germes et placenta
 Pinze per aborto e placenta

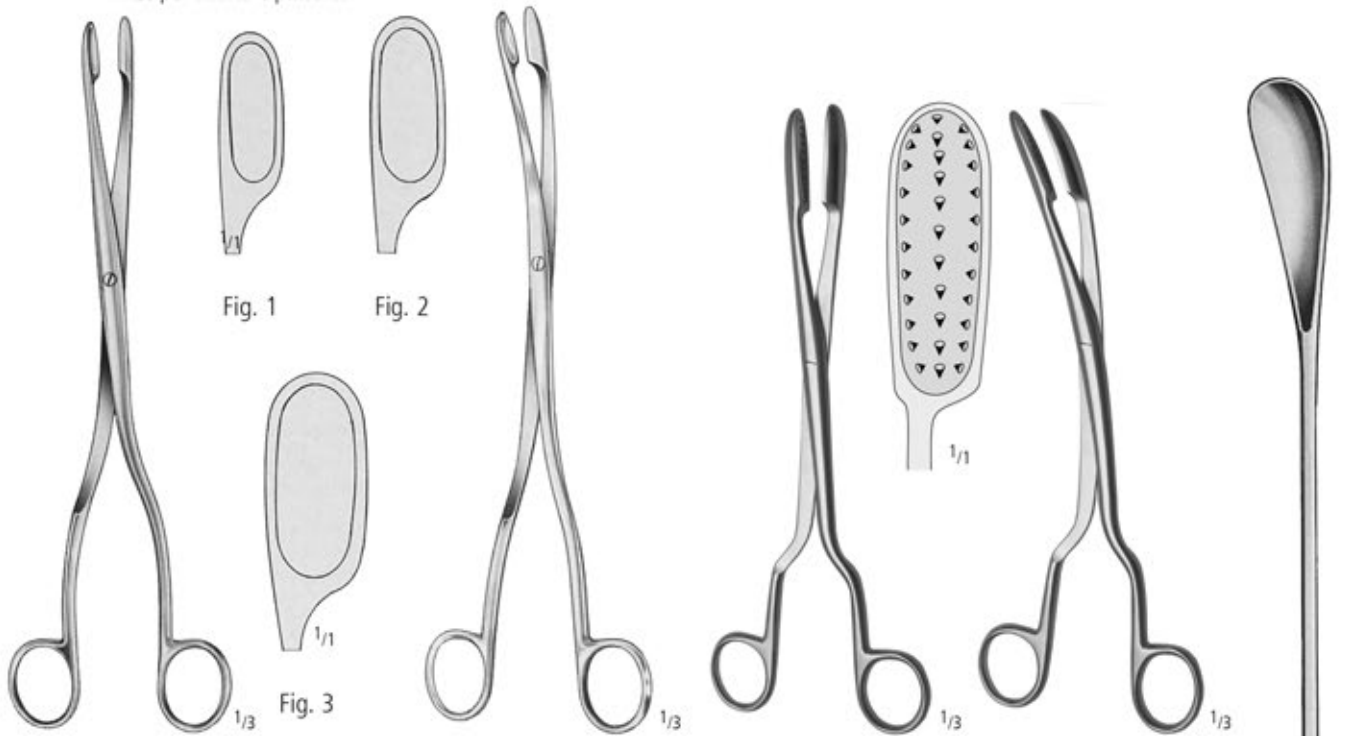

WINTER
 28,0 cm/11"
 Fig. 1 KB 780/01
 Fig. 2 KB 780/02
 Fig. 3 KB 780/03

WINTER
 28,0 cm/11"
 Fig. 1 KB 781/01
 Fig. 2 KB 781/02
 Fig. 3 KB 781/03

LEWKOWITZ
 24,5 cm/9³/₄"
 KB 782/25

LEWKOWITZ
 24,5 cm/9³/₄"
 KB 783/25

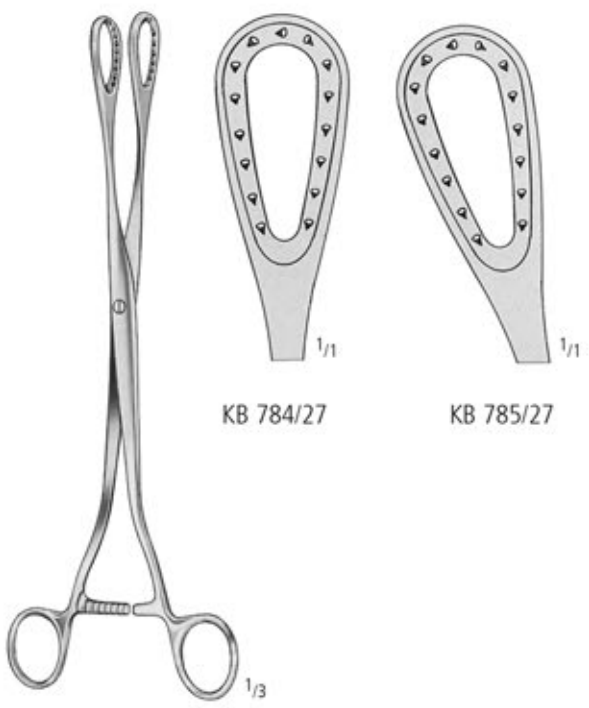

SAENGER
 27,0 cm/10³/₄"

GREEN-ARMYTAGE
 KB 786/21
 21,0 cm/8¹/₄"

WALLICH
 KB 787/42
 42,0 cm/16¹/₂"

Perforatorien, Dekapitationshaken
 Perforators, Decapitating Hooks
 Perfora-crâneos, Ganchos para decapitación
 Perce-crânes, Crochets pour détroncation
 Spezzacrani, Uncino per detroncazione



NAEGELE
 KB 788/25
 25,0 cm/10"



SPELLIE
 KB 790/25
 25,0 cm/10"



BRAUN
 KB 791/30
 30,0 cm/12"



SPELLIE
 KB 792/30
 30,0 cm/12"

AA
 AB
 AC
 AD
 AE
 AF
 AG
 AH
 AI
 AJ
 AK
 AL
 AM
 AN
 AO
 AP
 AQ
 AR
 AS
 AT
 AU
 AV
 AW
 AX
 AY
 AZ
 BA
 BB
 BC
 BD
 BE
 BF
 BG
 BH
 BI
 BJ
 BK
 BL
 BM
 BN
 BO
 BP
 BQ
 BR
 BS
 BT
 BU
 BV
 BW
 BX
 BY
 BZ
 CA
 CB
 CC
 CD
 CE
 CF
 CG
 CH
 CI
 CJ
 CK
 CL
 CM
 CN
 CO
 CP
 CQ
 CR
 CS
 CT
 CU
 CV
 CW
 CX
 CY
 CZ
 DA
 DB
 DC
 DD
 DE
 DF
 DG
 DH
 DI
 DJ
 DK
 DL
 DM
 DN
 DO
 DP
 DQ
 DR
 DS
 DT
 DU
 DV
 DW
 DX
 DY
 DZ
 EA
 EB
 EC
 ED
 EE
 EF
 EG
 EH
 EI
 EJ
 EK
 EL
 EM
 EN
 EO
 EP
 EQ
 ER
 ES
 ET
 EU
 EV
 EW
 EX
 EY
 EZ
 FA
 FB
 FC
 FD
 FE
 FF
 FG
 FH
 FI
 FJ
 FK
 FL
 FM
 FN
 FO
 FP
 FQ
 FR
 FS
 FT
 FU
 FV
 FW
 FX
 FY
 FZ
 GA
 GB
 GC
 GD
 GE
 GF
 GG
 GH
 GI
 GJ
 GK
 GL
 GM
 GN
 GO
 GP
 GQ
 GR
 GS
 GT
 GU
 GV
 GW
 GX
 GY
 GZ
 HA
 HB
 HC
 HD
 HE
 HF
 HG
 HH
 HI
 HJ
 HK
 HL
 HM
 HN
 HO
 HP
 HQ
 HR
 HS
 HT
 HU
 HV
 HW
 HX
 HY
 HZ
 IA
 IB
 IC
 ID
 IE
 IF
 IG
 IH
 II
 IJ
 IK
 IL
 IM
 IN
 IO
 IP
 IQ
 IR
 IS
 IT
 IU
 IV
 IW
 IX
 IY
 IZ
 JA
 JB
 JC
 JD
 JE
 JF
 JG
 JH
 JI
 JJ
 JK
 JL
 JM
 JN
 JO
 JP
 JQ
 JR
 JS
 JT
 JU
 JV
 JW
 JX
 JY
 JZ
 KA
 KB
 KC
 KD
 KE
 KF
 KG
 KH
 KI
 KJ
 KK
 KL
 KM
 KN
 KO
 KP
 KQ
 KR
 KS
 KT
 KU
 KV
 KW
 KX
 KY
 KZ
 LA
 LB
 LC
 LD
 LE
 LF
 LG
 LH
 LI
 LJ
 LK
 LL
 LM
 LN
 LO
 LP
 LQ
 LR
 LS
 LT
 LU
 LV
 LW
 LX
 LY
 LZ
 MA
 MB
 MC
 MD
 ME
 MF
 MG
 MH
 MI
 MJ
 MK
 ML
 MM
 MN
 MO
 MP
 MQ
 MR
 MS
 MT
 MU
 MV
 MW
 MX
 MY
 MZ
 NA
 NB
 NC
 ND
 NE
 NF
 NG
 NH
 NI
 NJ
 NK
 NL
 NM
 NN
 NO
 NP
 NQ
 NR
 NS
 NT
 NU
 NV
 NW
 NX
 NY
 NZ
 OA
 OB
 OC
 OD
 OE
 OF
 OG
 OH
 OI
 OJ
 OK
 OL
 OM
 ON
 OO
 OP
 OQ
 OR
 OS
 OT
 OU
 OV
 OW
 OX
 OY
 OZ
 PA
 PB
 PC
 PD
 PE
 PF
 PG
 PH
 PI
 PJ
 PK
 PL
 PM
 PN
 PO
 PP
 PQ
 PR
 PS
 PT
 PU
 PV
 PW
 PX
 PY
 PZ
 QA
 QB
 QC
 QD
 QE
 QF
 QG
 QH
 QI
 QJ
 QK
 QL
 QM
 QN
 QO
 QP
 QQ
 QR
 QS
 QT
 QU
 QV
 QW
 QX
 QY
 QZ
 RA
 RB
 RC
 RD
 RE
 RF
 RG
 RH
 RI
 RJ
 RK
 RL
 RM
 RN
 RO
 RP
 RQ
 RR
 RS
 RT
 RU
 RV
 RW
 RX
 RY
 RZ
 SA
 SB
 SC
 SD
 SE
 SF
 SG
 SH
 SI
 SJ
 SK
 SL
 SM
 SN
 SO
 SP
 SQ
 SR
 SS
 ST
 SU
 SV
 SW
 SX
 SY
 SZ
 TA
 TB
 TC
 TD
 TE
 TF
 TG
 TH
 TI
 TJ
 TK
 TL
 TM
 TN
 TO
 TP
 TQ
 TR
 TS
 TT
 TU
 TV
 TW
 TX
 TY
 TZ
 UA
 UB
 UC
 UD
 UE
 UF
 UG
 UH
 UI
 UJ
 UK
 UL
 UM
 UN
 UO
 UP
 UQ
 UR
 US
 UT
 UY
 UZ
 VA
 VB
 VC
 VD
 VE
 VF
 VG
 VH
 VI
 VJ
 VK
 VL
 VM
 VN
 VO
 VP
 VQ
 VR
 VS
 VT
 VU
 VV
 VW
 VX
 VY
 VZ
 WA
 WB
 WC
 WD
 WE
 WF
 WG
 WH
 WI
 WJ
 WK
 WL
 WM
 WN
 WO
 WP
 WQ
 WR
 WS
 WT
 WU
 WV
 WW
 WX
 WY
 WZ
 XA
 XB
 XC
 XD
 XE
 XF
 XG
 XH
 XI
 XJ
 XK
 XL
 XM
 XN
 XO
 XP
 XQ
 XR
 XS
 XT
 XU
 XV
 XW
 XX
 XY
 XZ
 YA
 YB
 YC
 YD
 YE
 YF
 YG
 YH
 YI
 YJ
 YK
 YL
 YM
 YN
 YO
 YP
 YQ
 YR
 YS
 YT
 YU
 YV
 YW
 YX
 YY
 YZ
 ZA
 ZB
 ZC
 ZD
 ZE
 ZF
 ZG
 ZH
 ZI
 ZJ
 ZK
 ZL
 ZM
 ZN
 ZO
 ZP
 ZQ
 ZR
 ZS
 ZT
 ZU
 ZV
 ZW
 ZX
 ZY
 ZZ

Basiotrib, Kranioklast
 Basiotribe, Cranioclast
 Basiotribo, Craneoclasto
 Basiotribe, Cranioclaste
 Basiotribo, Cranioclaste



TARNIER
 KB 798/46
 46,0 cm/18"



BRAUN
 KB 799/42
 42,0 cm/16¹/₂"

Instrumente für die Amnionblase
 Instruments for the amnion bladder
 Instrumentos para la vesícula amniótica
 Instruments pour la vésicule amniotique
 Strumenti per la vescicola amniotica



IOWA
 KB 801/14
 14,0 cm/5 1/2"



IOWA
 KB 805/26
 26,0 cm/10 1/2"



BEACHAM
 KB 806/26
 26,0 cm/10 1/2"

AA
 AB
 AC
 AD
 AE
 AF
 AK
 AL
 AO
 AP
 AR
KB
 KI
 KC
 KU
 KYE
 X

Nabelschnurklemmen
 Umbilical cord clamps
 Clamps umbilicales
 Clamps ombilicaux
 Clamps cordone ombelicale



KANE
 KB 808/85
 8,5 cm/3¹/₄"



COLLIN
 KB 810/85
 8,5 cm/3¹/₄"



KB 812/06
 6,0 cm/2¹/₂"



POM-C
 Single use

MAMMAPLASTIK
MAMMAPLASTY
MAMMAPLASTIA
PLASTIE MAMMAIRE
PLASTICA MAMMARIA

KI

nopa[®] instruments



Brustretractoren
 Mammaplasty retractors
 Separadores de Mammaplastia
 Ecarteurs pour la Plastie mammaire
 Divaricatori per la Plastica mammaria

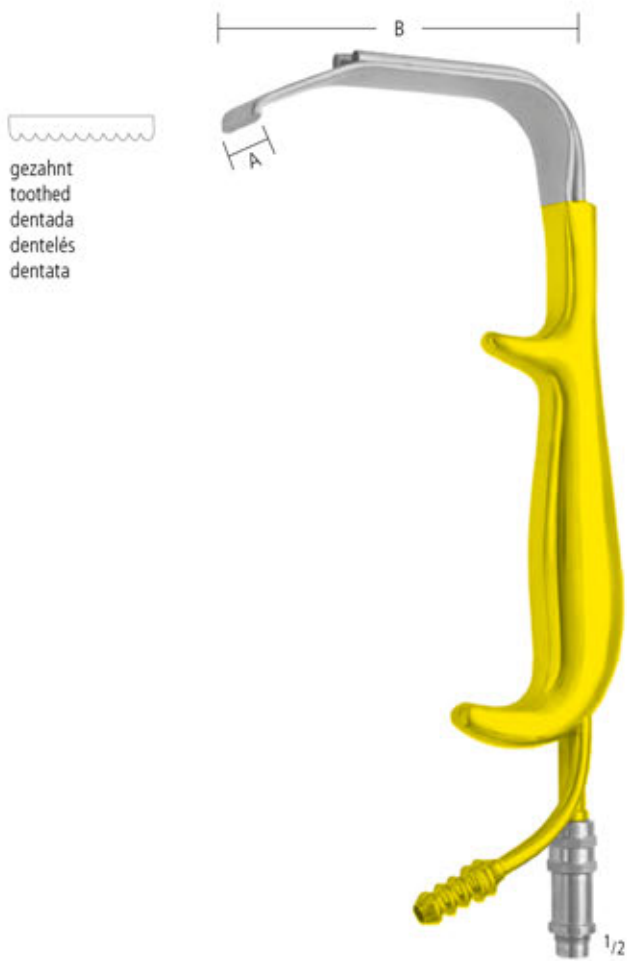

mit Kaltlicht
 with fibre-optic illumination

A x B	
16 x 80 mm	KI 013/08
16 x 150 mm	KI 013/15
25 x 90 mm	KI 014/09
25 x 150 mm	KI 014/15
25 x 180 mm	KI 014/18

mit Kaltlicht und Absaugung
 with fibre-optic illumination and smoke excavation

A x B	
16 x 80 mm	KI 015/08
16 x 150 mm	KI 015/15
25 x 90 mm	KI 016/09
25 x 150 mm	KI 016/15
25 x 180 mm	KI 016/18

TEBETTS
 23,0 cm/9"

MAMMAPLASTIK MAMMAPLASTY MAMMAPLASTIA PLASTIE MAMMAIRE PLASTICA MAMMARIA

Brustretractoren
 Mammoplasty retractors
 Separadores de Mammoplastia
 Ecarteurs pour la Plastie mammaire
 Divaricatori per la Plastica mammaria

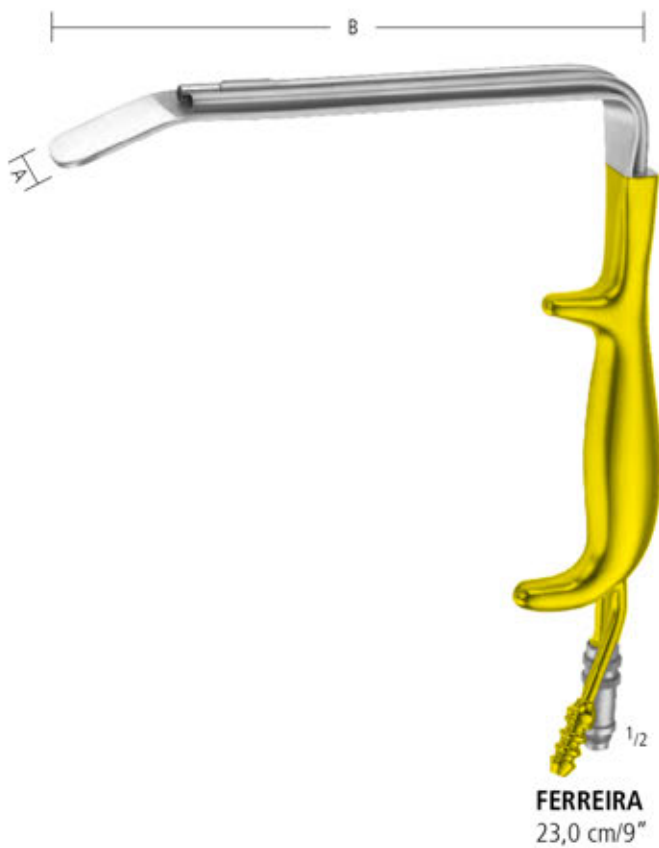

mit Kaltlicht
 with fibre-optic illumination

A x B	
16 x 80 mm	KI 023/08
16 x 150 mm	KI 023/15
25 x 90 mm	KI 024/09
25 x 150 mm	KI 024/15
25 x 180 mm	KI 024/18

mit Kaltlicht und Absaugung
 with fibre-optic illumination and smoke excavation

A x B	
16 x 80 mm	KI 025/08
16 x 150 mm	KI 025/15
25 x 90 mm	KI 026/09
25 x 150 mm	KI 026/15
25 x 180 mm	KI 026/18

AA
 AB
 AC
 AD
 AE
 AF
 AK
 AL
 AO
 AP
 AR
 KB
 KI
 KC
 KU
 KYE
 X

Brustretractoren
 Mammaplasty retractors
 Separadores de Mammoplastia
 Ecarteurs pour la Plastique mammaire
 Divaricatori per la Plastica mammaria

37 x 70 mm

gezahnt
 toothed
 dentada
 dentelés
 dentata



gezahnt
 toothed
 dentada
 dentelés
 dentata

22 x 54 mm

TEBBETS
 KI 030/01
 23,0 cm/9"

mit Kaltlichtbeleuchtung
 with fibre-optic illumination



FREEMAN Flap
 20,0 cm/8"
 B = 12 mm KI 050/12
 B = 25 mm KI 050/25

MAMMAPLASTIK MAMMAPLASTY MAMMAPLASTIA PLASTIE MAMMAIRE PLASTICA MAMMARIA

Brustretractoren
 Mammoplasty retractors
 Separadores de Mammoplastia
 Ecarteurs pour la Plastie mammaire
 Divaricatori per la Plastica mammaria



Zur Verwendung mit Optiken Ø 4 mm, Breite 25 mm
 For use with telescopes Ø 4 mm, width 25 mm

KI 060/04
 18,0 cm/7"

Zur Verwendung mit Optiken Ø 10 mm, Breite 25 mm
 For use with telescopes Ø 10 mm, width 25 mm

KI 060/10
 18,0 cm/7"

AA

AB

AC

AD

AE

AF

AK

AL

AO

AP

AR

KB

KI

KC

KU

KYE

X

KI MAMMAPLASTIK MAMMAPLASTY MAMMAPLASTIA PLASTIE MAMMAIRE PLASTICA MAMMARIA

Brustdissektoren
 Breast dissectors
 Disectores mamarios
 Dissecteurs mammaires
 Dissettori mammari

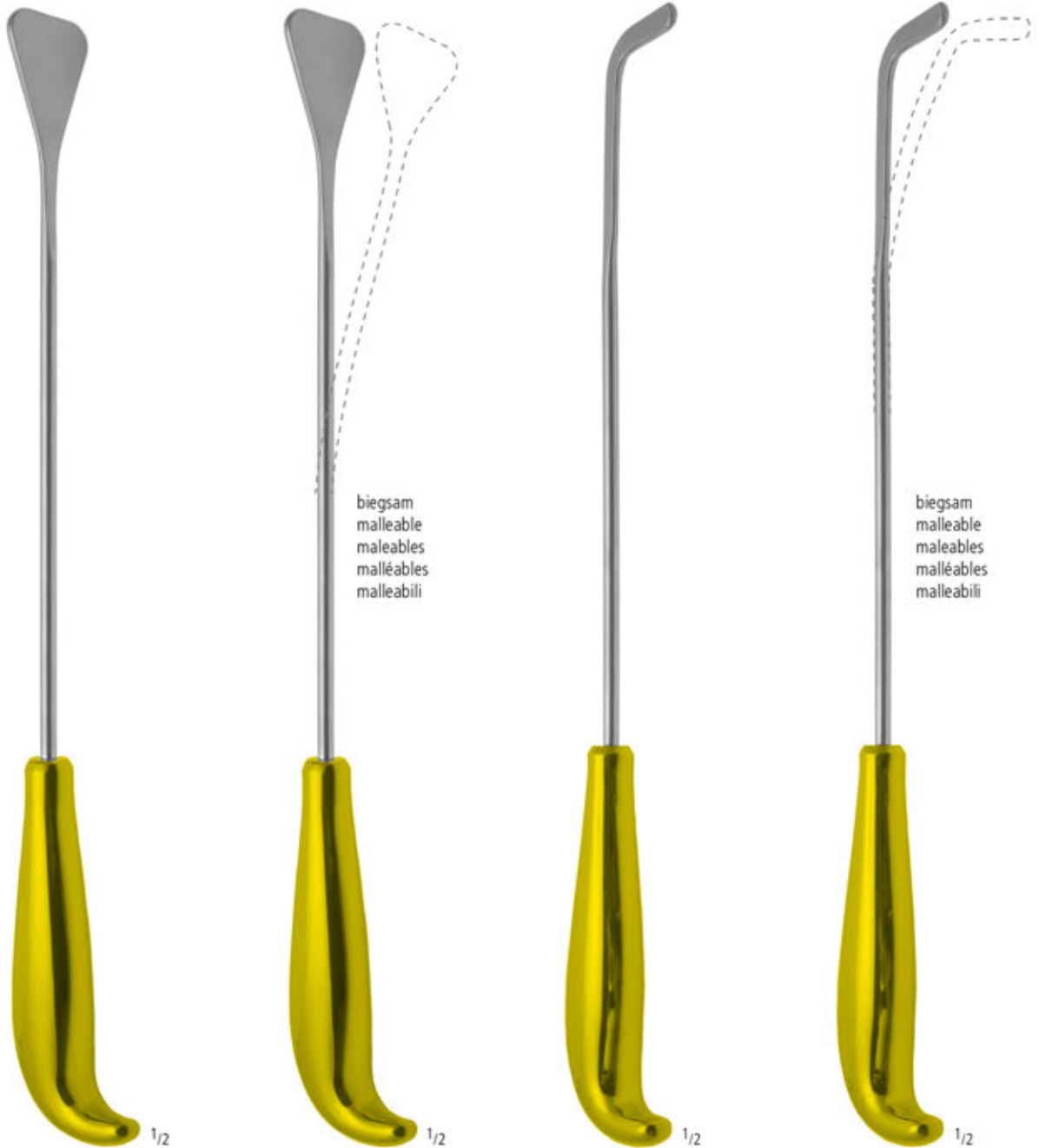

biegsam
 malleable
 maleables
 malléables
 malleabili

biegsam
 malleable
 maleables
 malléables
 malleabili

33,0 cm/13"
 42,0 cm/16 1/2"

KI 101/33
 KI 101/42

KI 102/33
 KI 102/42

KI 104/33
 KI 104/42

KI 105/33
 KI 105/42

MAMMAPLASTIK MAMMAPLASTY MAMMAPLASTIA PLASTIE MAMMAIRE PLASTICA MAMMARIA

Brustdissektoren
 Breast dissectors
 Disectores mamarios
 Dissecteurs mammaires
 Dissettori mammari

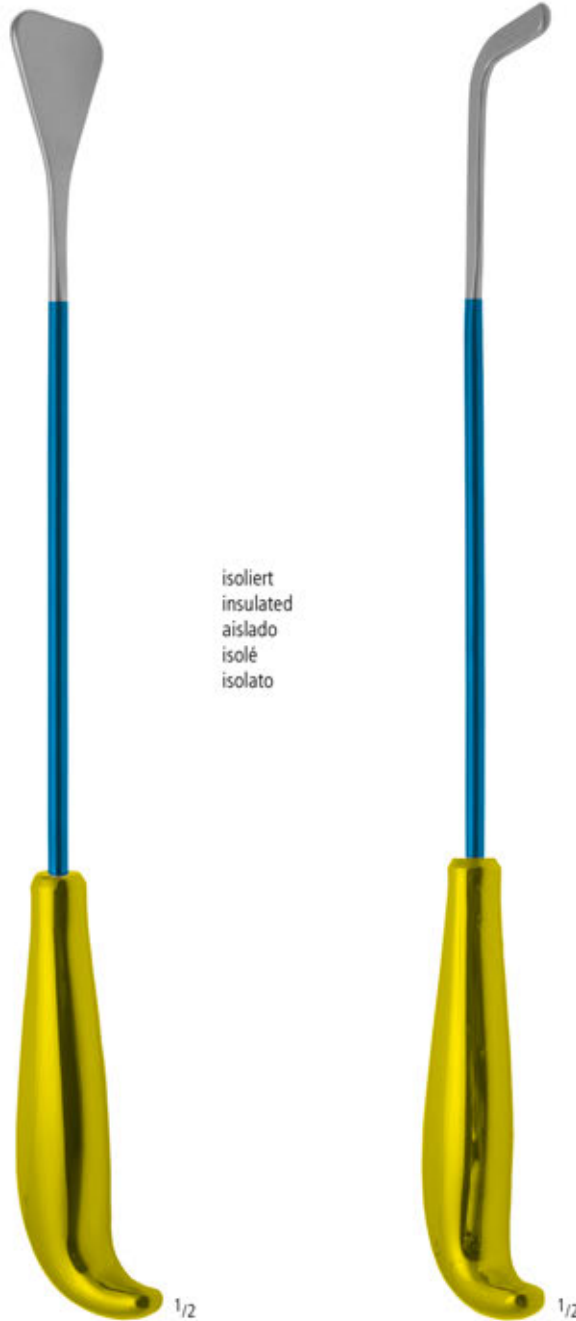

isoliert
 insulated
 aislado
 isolé
 isolato

33,0 cm/13"
 42,0 cm/16½"

KI 107/33
 KI 107/42

KI 108/33
 KI 108/42

AA
 AB
 AC
 AD
 AE
 AF
 AK
 AL
 AO
 AP
 AR
 KB
KI
 KC
 KU
 KYE
 X

KI MAMMAPLASTIK MAMMAPLASTY MAMMAPLASTIA PLASTIE MAMMAIRE PLASTICA MAMMARIA

Brustdissektoren
 Breast dissectors
 Disectores mamarios
 Dissecteurs mammaires
 Dissettori mammari



McCOLLUM-DINGMAN
 KI 112/41
 41,0 cm/16"



McCOLLUM-DINGMAN
 KI 114/30
 30,0 cm/12"



AGRIS-DINGMAN
 KI 116/36
 36,0 cm/14¹/₄"



AGRIS-DINGMAN
 KI 117/36
 36,0 cm/14¹/₄"

MAMMAPLASTIK MAMMAPLASTY MAMMAPLASTIA PLASTIE MAMMAIRE PLASTICA MAMMARIA

Areola Markierer
 Areola markers
 Marcadores para la aréola
 Marqueurs pour l'aréole
 Marcatori per areola



FREEMAN
 double-ended 38 + 42 mm
 KI 208/00



FREEMAN
 38 mm/1 1/2" KI 208/38
 42 mm/1 3/4" KI 208/42



McKISSOCK
 3,8 cm/1 1/2" KI 220/38
 4,2 cm/1 3/4" KI 220/42
 4,5 cm/1 3/4" KI 220/45



ACKERMANN
 14,0 cm/5 1/2" KI 230/14
 16,0 cm/6 1/4" KI 230/16

AA
 AB
 AC
 AD
 AE
 AF
 AG
 AH
 AI
 AJ
 AK
 AL
 AM
 AN
 AO
 AP
 AQ
 AR
 AS
 AT
 AU
 AV
 AW
 AX
 AY
 AZ
 BA
 BB
 BC
 BD
 BE
 BF
 BG
 BH
 BI
 BJ
 BK
 BL
 BM
 BN
 BO
 BP
 BQ
 BR
 BS
 BT
 BU
 BV
 BW
 BX
 BY
 BZ
 CA
 CB
 CC
 CD
 CE
 CF
 CG
 CH
 CI
 CJ
 CK
 CL
 CM
 CN
 CO
 CP
 CQ
 CR
 CS
 CT
 CU
 CV
 CW
 CX
 CY
 CZ
 DA
 DB
 DC
 DD
 DE
 DF
 DG
 DH
 DI
 DJ
 DK
 DL
 DM
 DN
 DO
 DP
 DQ
 DR
 DS
 DT
 DU
 DV
 DW
 DX
 DY
 DZ
 EA
 EB
 EC
 ED
 EE
 EF
 EG
 EH
 EI
 EJ
 EK
 EL
 EM
 EN
 EO
 EP
 EQ
 ER
 ES
 ET
 EU
 EV
 EW
 EX
 EY
 EZ
 FA
 FB
 FC
 FD
 FE
 FF
 FG
 FH
 FI
 FJ
 FK
 FL
 FM
 FN
 FO
 FP
 FQ
 FR
 FS
 FT
 FU
 FV
 FW
 FX
 FY
 FZ
 GA
 GB
 GC
 GD
 GE
 GF
 GG
 GH
 GI
 GJ
 GK
 GL
 GM
 GN
 GO
 GP
 GQ
 GR
 GS
 GT
 GU
 GV
 GW
 GX
 GY
 GZ
 HA
 HB
 HC
 HD
 HE
 HF
 HG
 HH
 HI
 HJ
 HK
 HL
 HM
 HN
 HO
 HP
 HQ
 HR
 HS
 HT
 HU
 HV
 HW
 HX
 HY
 HZ
 IA
 IB
 IC
 ID
 IE
 IF
 IG
 IH
 II
 IJ
 IK
 IL
 IM
 IN
 IO
 IP
 IQ
 IR
 IS
 IT
 IU
 IV
 IW
 IX
 IY
 IZ
 JA
 JB
 JC
 JD
 JE
 JF
 JG
 JH
 JI
 JJ
 JK
 JL
 JM
 JN
 JO
 JP
 JQ
 JR
 JS
 JT
 JU
 JV
 JW
 JX
 JY
 JZ
 KA
 KB
 KC
 KD
 KE
 KF
 KG
 KH
 KI
 KJ
 KK
 KL
 KM
 KN
 KO
 KP
 KQ
 KR
 KS
 KT
 KU
 KV
 KW
 KX
 KY
 KZ
 LA
 LB
 LC
 LD
 LE
 LF
 LG
 LH
 LI
 LJ
 LK
 LL
 LM
 LN
 LO
 LP
 LQ
 LR
 LS
 LT
 LU
 LV
 LW
 LX
 LY
 LZ
 MA
 MB
 MC
 MD
 ME
 MF
 MG
 MH
 MI
 MJ
 MK
 ML
 MM
 MN
 MO
 MP
 MQ
 MR
 MS
 MT
 MU
 MV
 MW
 MX
 MY
 MZ
 NA
 NB
 NC
 ND
 NE
 NF
 NG
 NH
 NI
 NJ
 NK
 NL
 NM
 NN
 NO
 NP
 NQ
 NR
 NS
 NT
 NU
 NV
 NW
 NX
 NY
 NZ
 OA
 OB
 OC
 OD
 OE
 OF
 OG
 OH
 OI
 OJ
 OK
 OL
 OM
 ON
 OO
 OP
 OQ
 OR
 OS
 OT
 OU
 OV
 OW
 OX
 OY
 OZ
 PA
 PB
 PC
 PD
 PE
 PF
 PG
 PH
 PI
 PJ
 PK
 PL
 PM
 PN
 PO
 PP
 PQ
 PR
 PS
 PT
 PU
 PV
 PW
 PX
 PY
 PZ
 QA
 QB
 QC
 QD
 QE
 QF
 QG
 QH
 QI
 QJ
 QK
 QL
 QM
 QN
 QO
 QP
 QQ
 QR
 QS
 QT
 QU
 QV
 QW
 QX
 QY
 QZ
 RA
 RB
 RC
 RD
 RE
 RF
 RG
 RH
 RI
 RJ
 RK
 RL
 RM
 RN
 RO
 RP
 RQ
 RR
 RS
 RT
 RU
 RV
 RW
 RX
 RY
 RZ
 SA
 SB
 SC
 SD
 SE
 SF
 SG
 SH
 SI
 SJ
 SK
 SL
 SM
 SN
 SO
 SP
 SQ
 SR
 SS
 ST
 SU
 SV
 SW
 SX
 SY
 SZ
 TA
 TB
 TC
 TD
 TE
 TF
 TG
 TH
 TI
 TJ
 TK
 TL
 TM
 TN
 TO
 TP
 TQ
 TR
 TS
 TT
 TU
 TV
 TW
 TX
 TY
 TZ
 UA
 UB
 UC
 UD
 UE
 UF
 UG
 UH
 UI
 UJ
 UK
 UL
 UM
 UN
 UO
 UP
 UQ
 UR
 US
 UT
 UY
 UZ
 VA
 VB
 VC
 VD
 VE
 VF
 VG
 VH
 VI
 VJ
 VK
 VL
 VM
 VN
 VO
 VP
 VQ
 VR
 VS
 VT
 VU
 VV
 VW
 VX
 VY
 VZ
 WA
 WB
 WC
 WD
 WE
 WF
 WG
 WH
 WI
 WJ
 WK
 WL
 WM
 WN
 WO
 WP
 WQ
 WR
 WS
 WT
 WU
 WV
 WW
 WX
 WY
 WZ
 XA
 XB
 XC
 XD
 XE
 XF
 XG
 XH
 XI
 XJ
 XK
 XL
 XM
 XN
 XO
 XP
 XQ
 XR
 XS
 XT
 XU
 XV
 XW
 XX
 XY
 XZ
 YA
 YB
 YC
 YD
 YE
 YF
 YG
 YH
 YI
 YJ
 YK
 YL
 YM
 YN
 YO
 YP
 YQ
 YR
 YS
 YT
 YU
 YV
 YW
 YX
 YZ
 ZA
 ZB
 ZC
 ZD
 ZE
 ZF
 ZG
 ZH
 ZI
 ZJ
 ZK
 ZL
 ZM
 ZN
 ZO
 ZP
 ZQ
 ZR
 ZS
 ZT
 ZU
 ZV
 ZW
 ZX
 ZY
 ZZ



UROLOGIE
UROLOGY
UROLOGIA
UROLOGIE
UROLOGIA

KC

nopa[®] instruments

UROLOGY



Vasektomieklemmen
 Vasectomy Forceps
 Pinzas de vasectomia
 Pincas de vasectomie
 Pinze de vasectomia

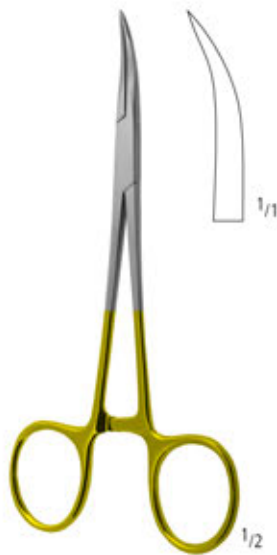

KC 040/01
 14,0 cm/5 1/2"



KC 040/02
 14,0 cm/5 1/2"

UROLOGIE UROLOGY UROLOGIA UROLOGIE UROLOGIA

Nierensteinzangen
Kidney Stone Forceps
Pinzas para cálculos renales
Pincas pour les calculs du bassinet
Pinza per calcoli renali

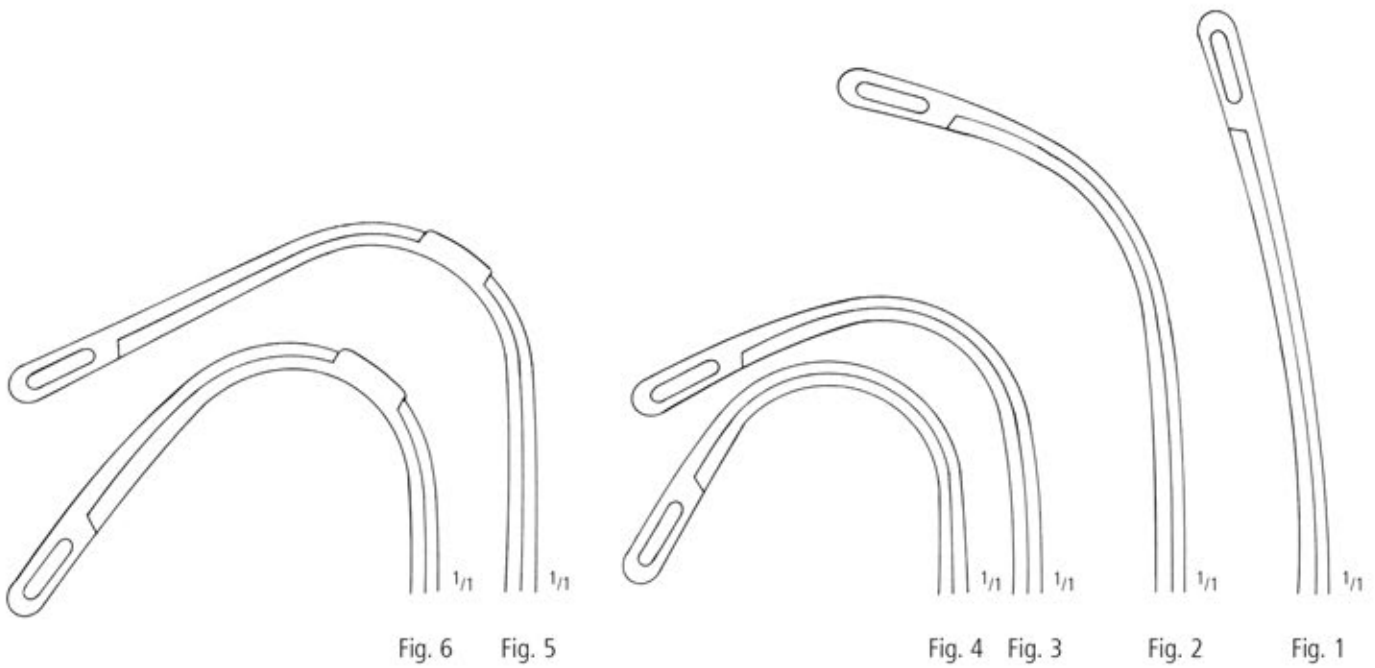
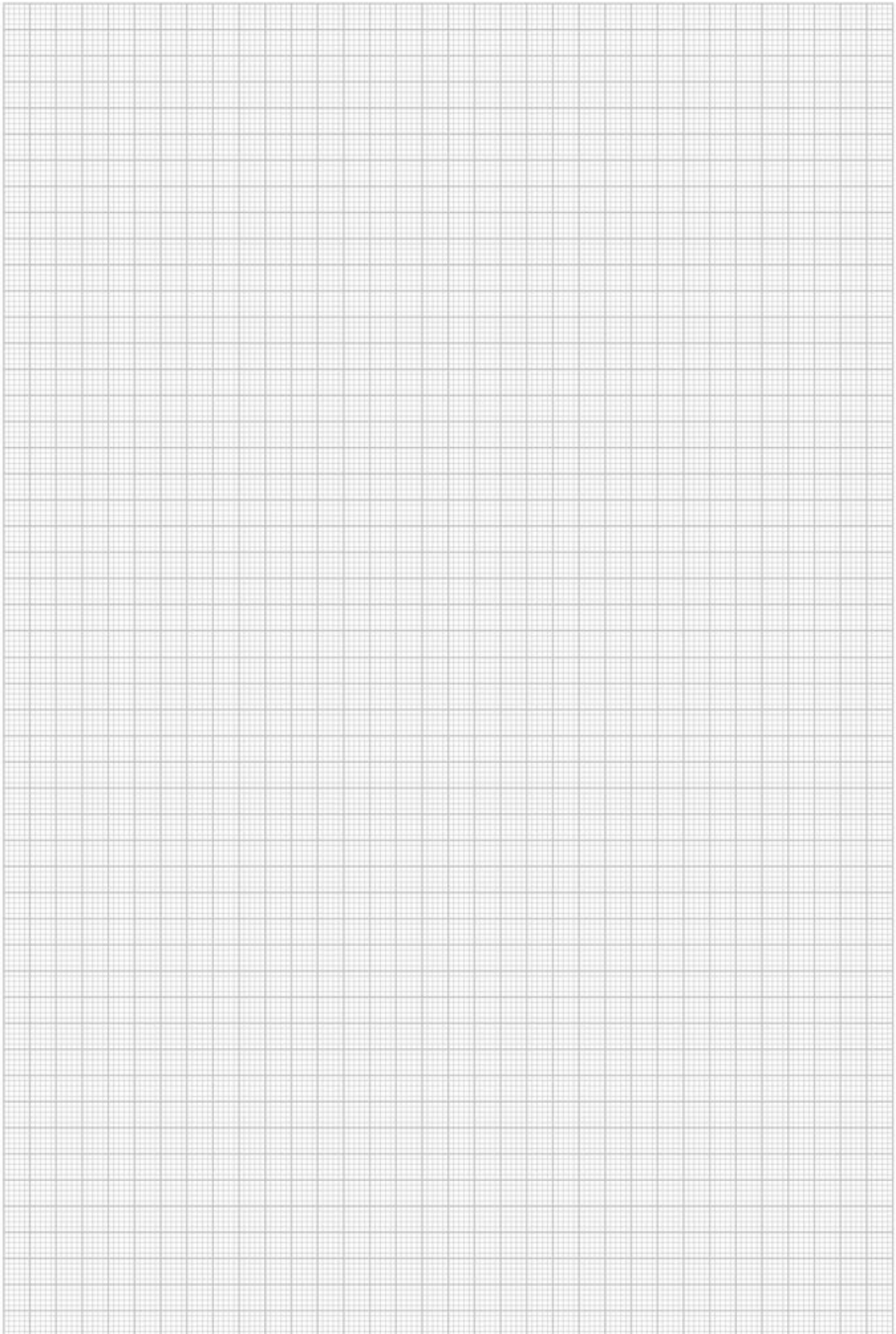

Fig.	cm / in.	RANDALL
1	23,0/9"	KC 051/01
2	22,0/8 ³ / ₄ "	KC 051/02
3	22,0/8 ³ / ₄ "	KC 051/03
4	22,0/8 ³ / ₄ "	KC 051/04
5	19,0/7 ¹ / ₂ "	KC 051/05
6	19,0/7 ¹ / ₂ "	KC 051/06

AA
AB
AC
AD
AE
AF
AK
AL
AO
AP
AR
KB
KI
KC
KU
KYE
X

KC



Nierenfasszange
Kidney Elevating Forceps
Pinzas para coger renales
Pinces pour prehension de rein
Pinzas per la presa dei reni



COLLIN
KC 053/29
28,5 cm/11¹/₄"

AA

AB

AC

AD

AE

AF

AK

AL

AO

AP

AR

KB

KI

KC

KU

KYE

X

Tangentialklemmen
Tangential Forceps
Pinzas tangenciales
Pinces à tangential
Pinze per tangential



URO-TANGENTIAL
26,0 cm/10¹/₂"



KC 055/01



KC 055/02

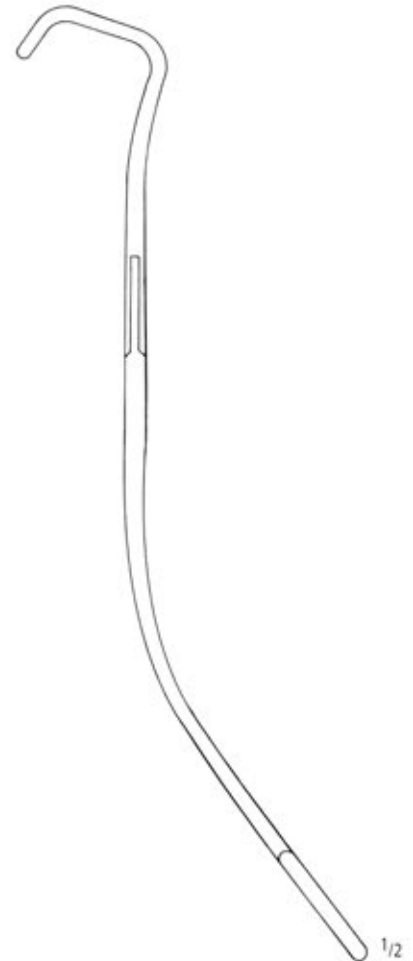

UROLOGIE UROLOGY UROLOGIA UROLOGIE UROLOGIA

Gallensteinsonden, Gallenkanal Dilatatoren
 Gall Stone Probes, Gall Duct Dilators
 Exploradores para cálculos biliares, Dilatadores para conductos biliares
 Explorateurs à calculs biliaires, Dilatateurs à voies biliaires
 Sonde per calcoli biliari, Dilatatori per condotti biliari

AA
AB
AC
AD
AE
AF
AK
AL
AO
AP
AR
KB
KI
KC
KU
KYE
X



MOYNIHAN
 KC 110/34
 34,0 cm/13¹/₃"



DESJARDINS
 28,0 cm/11"



BAKES
 30,0 cm/12"

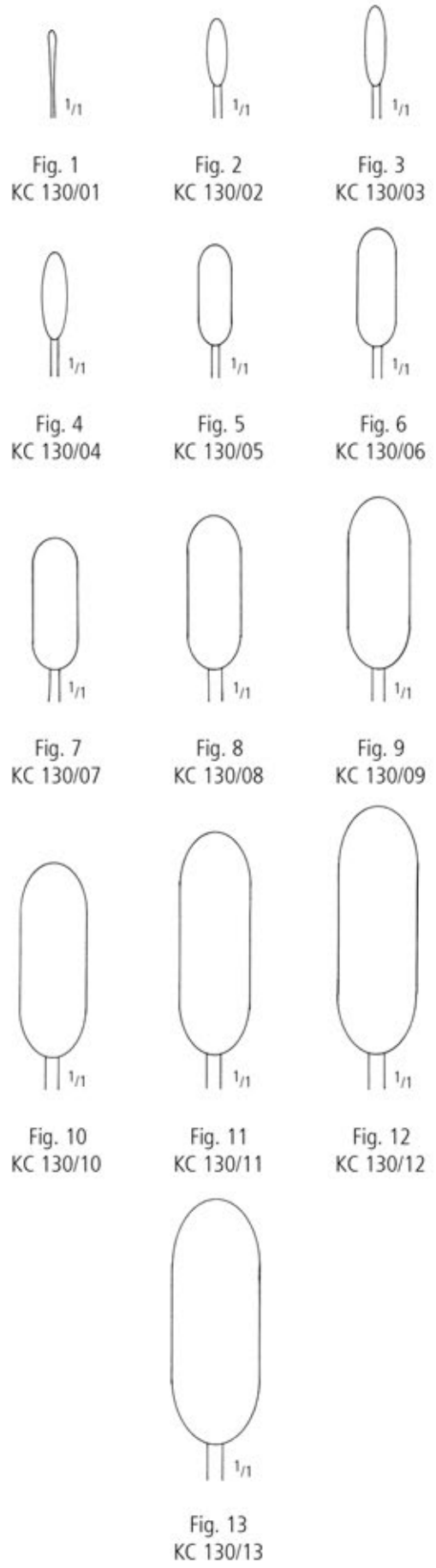

Gallensteinzangen
 Gall Stone Forceps
 Pinzas para cálculos biliares
 Pincès pour calculs biliaires
 Pinze per calcoli biliari

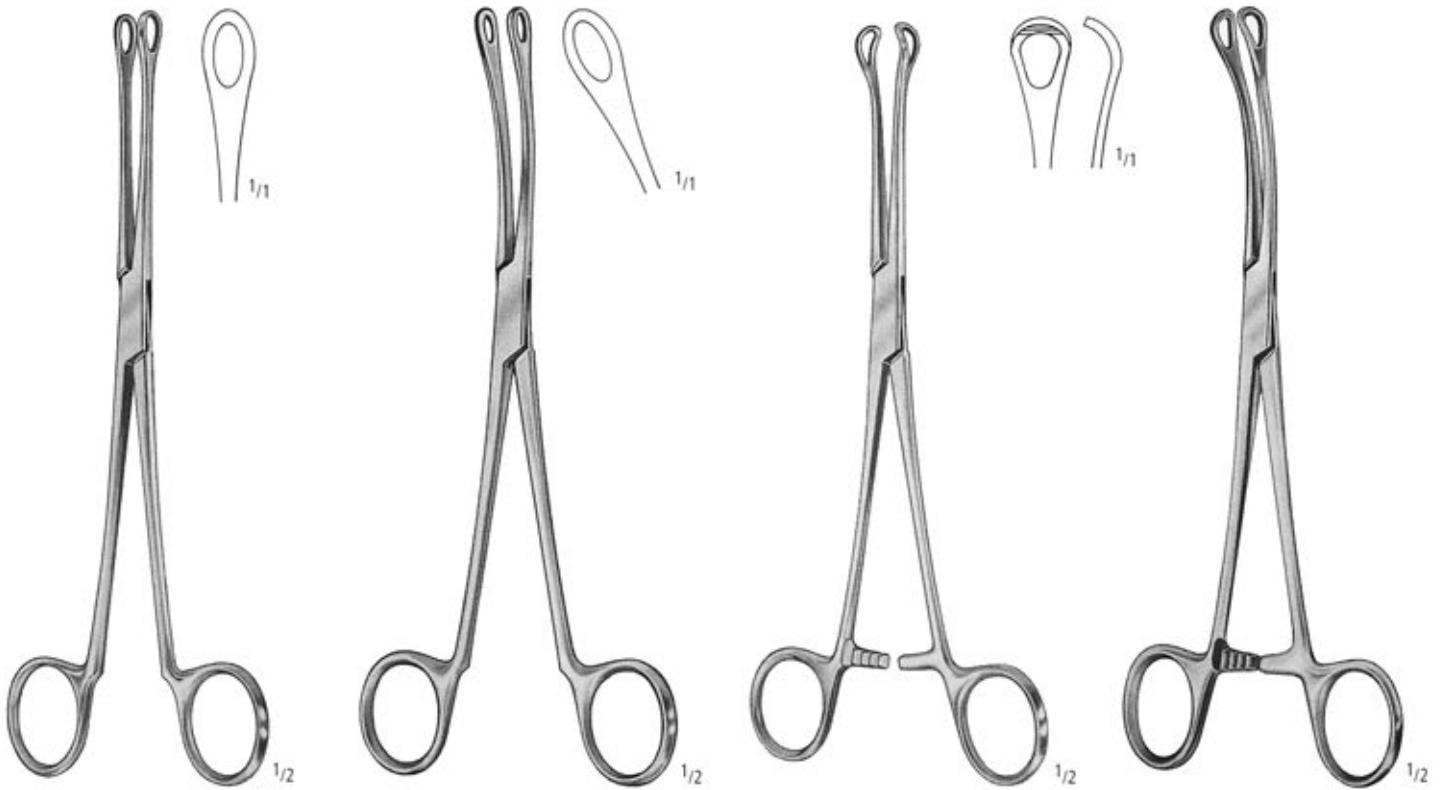

BLAKE
 KC 186/20
 20,0 cm/8"



BLAKE
 KC 187/20
 20,0 cm/8"

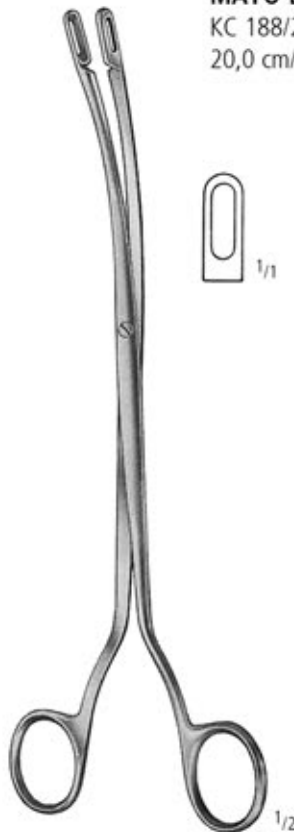

MAYO-BLAKE
 KC 188/20
 20,0 cm/8"



MAYO-BLAKE
 KC 189/20
 20,0 cm/8"

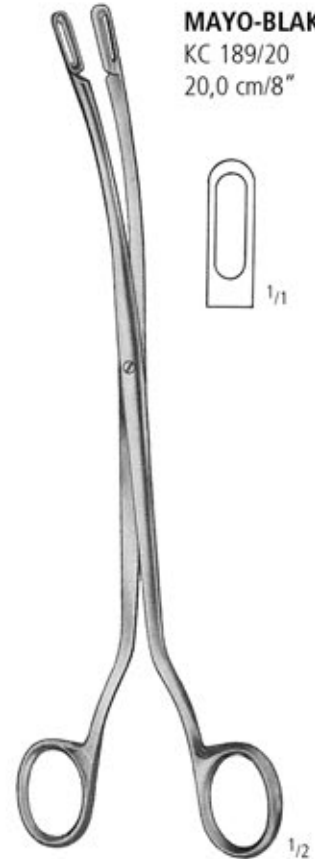

MIXTER
 KC 190/22
 22,0 cm/8³/₄"

DESJARDINS
 KC 191/01
 23,0 cm/9"

DESJARDINS
 KC 191/02
 23,0 cm/9"

Gallensteinlöffel
 Gall Stone Scoops
 Cucharillas para coger cálculos biliares
 Curettes pour calculs biliaires
 Cucchiari per calcoli biliari



DESJARDINS
 30,0 cm/12"



LUER-KOERTE
 32,0 cm/12³/₄"

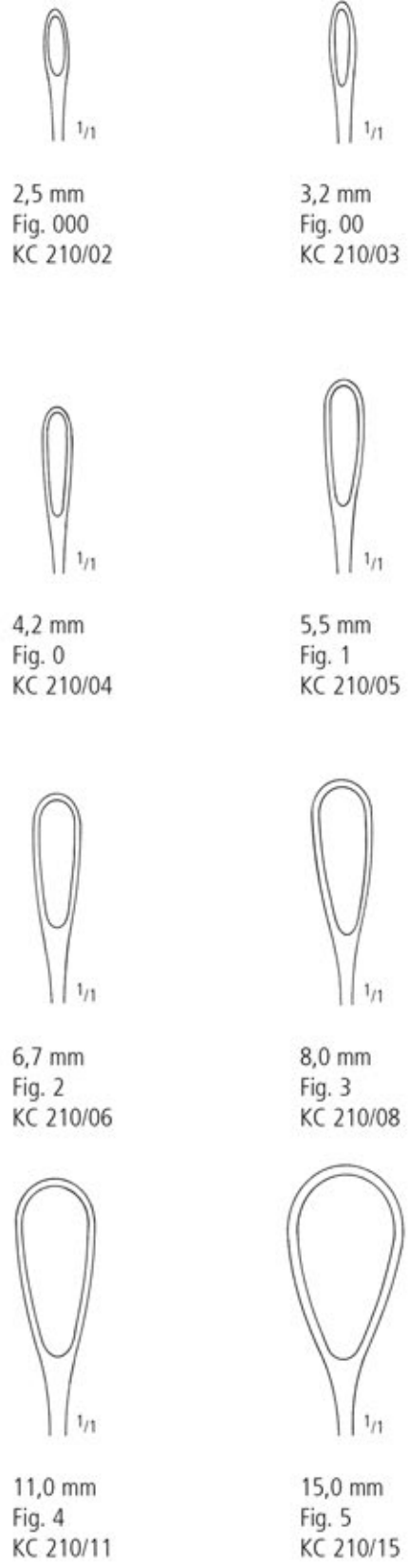

AA
 AB
 AC
 AD
 AE
 AF
 AK
 AL
 AO
 AP
 AR
 KB
 KI
KC
 KU
 KYE
 X

Prostatahaken
 Prostatic Retractors
 Separadores para la próstata
 Ecarteurs prostatiques
 Divaricatori prostatici

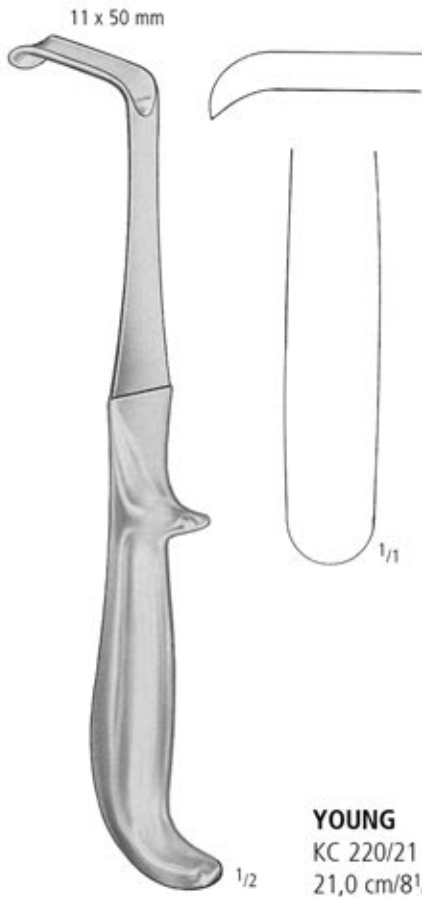

YOUNG
 KC 220/21
 21,0 cm/8¹/₄"

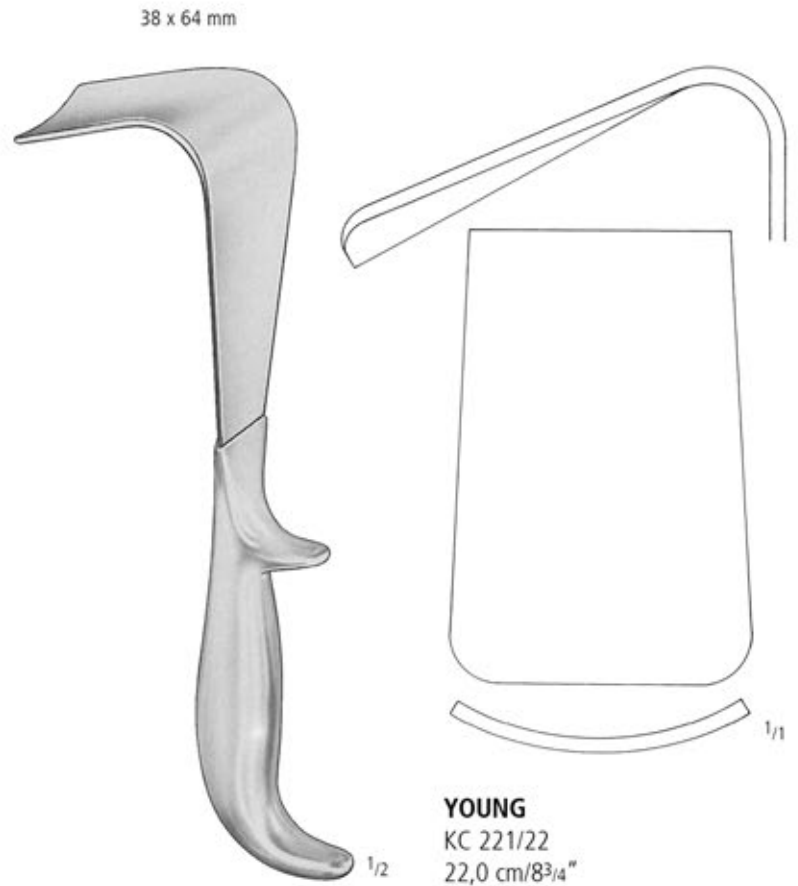

YOUNG
 KC 221/22
 22,0 cm/8³/₄"

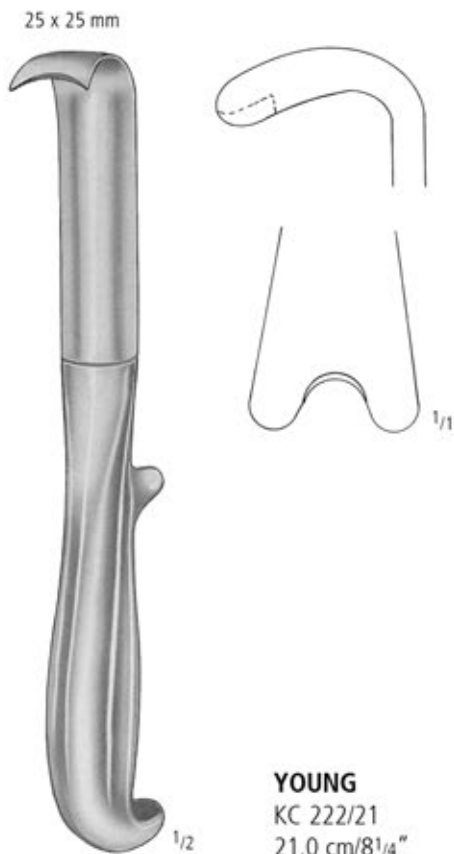

YOUNG
 KC 222/21
 21,0 cm/8¹/₄"

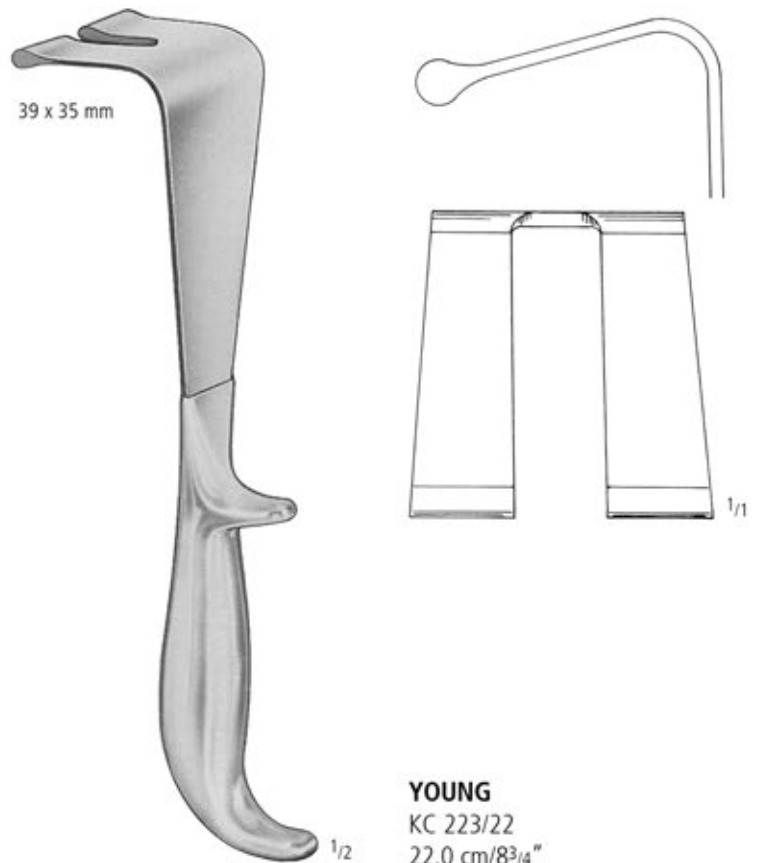

YOUNG
 KC 223/22
 22,0 cm/8³/₄"

Instrumente für Prostata-Operationen
 Prostatectomy Instruments
 Instrumentos para prostatectomia
 Instruments pour prostatectomie
 Strumenti per operazioni della prostata

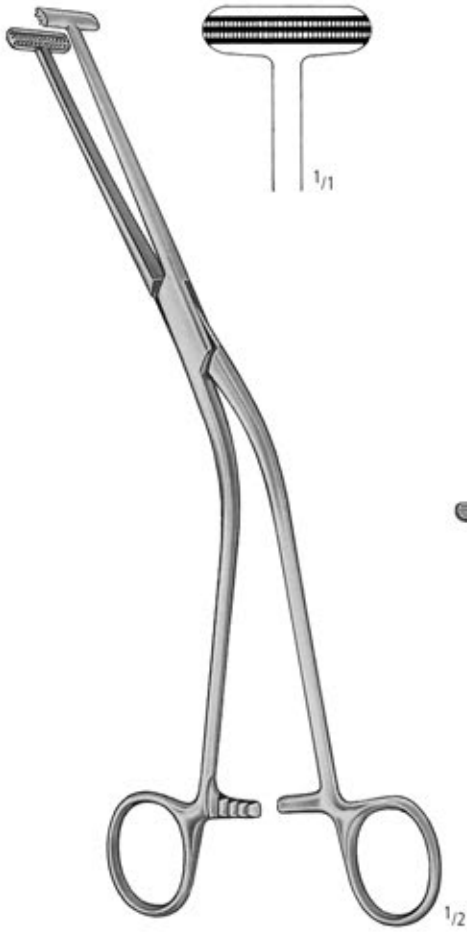

MILLIN
 KC 231/24
 24,0 cm/9 1/2"



MILLIN
 KC 241/01
 23,0 cm/9"

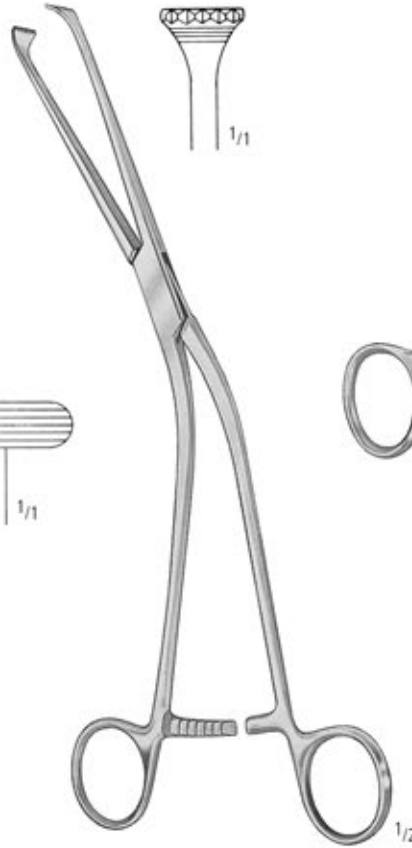

MILLIN
 KC 241/02
 23,0 cm/9"



MILLIN
 KC 241/03
 24,0 cm/9 1/2"

AA
 AB
 AC
 AD
 AE
 AF
 AK
 AL
 AO
 AP
 AR
 KB
 KI
 KU
 KYE
 X

KC

Urethrotom
 Urethrotome
 Uretrótomos
 Uréthrotomes
 Uretrotomi

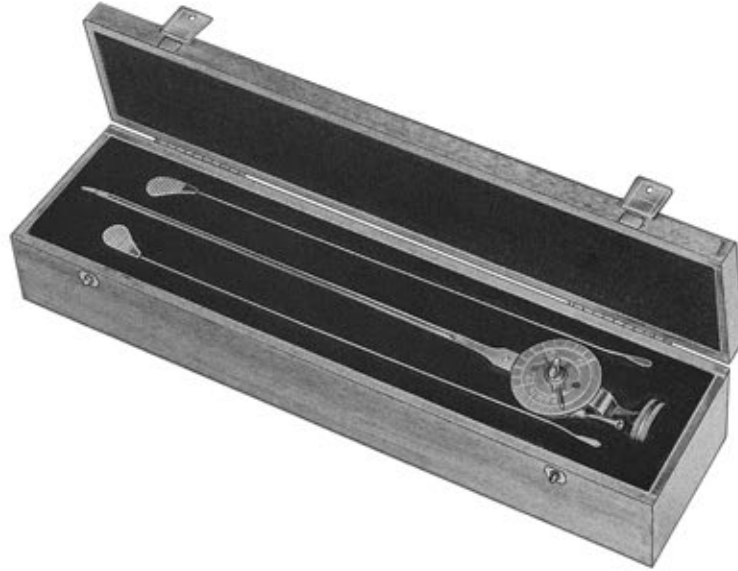

OTIS
 KC 246/00

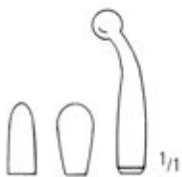
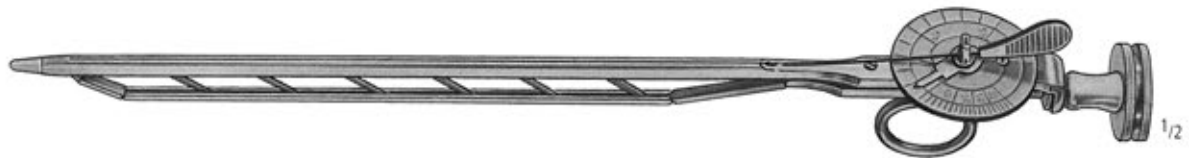

komplett
 complete
 completo
 complet
 completo



KC 246/10

Blasen-Wundspreizer
Bladder Retractors
Separadores vesicales
Ecarteurs vésicaux
Divaricatori vescicali



MILLIN
KC 310/00
28,0 cm/11"



LEGUEU
KC 320/00
17,0 cm/6³/₄"

AA
AB
AC
AD
AE
AF
AK
AL
AO
AP
AR
KB
KI
KC
KU
KYE
X

Blasen-Wundspreizer
Bladder Retractors
Separadores vesicales
Ecarteurs vésicaux
Divaricatori vescicali

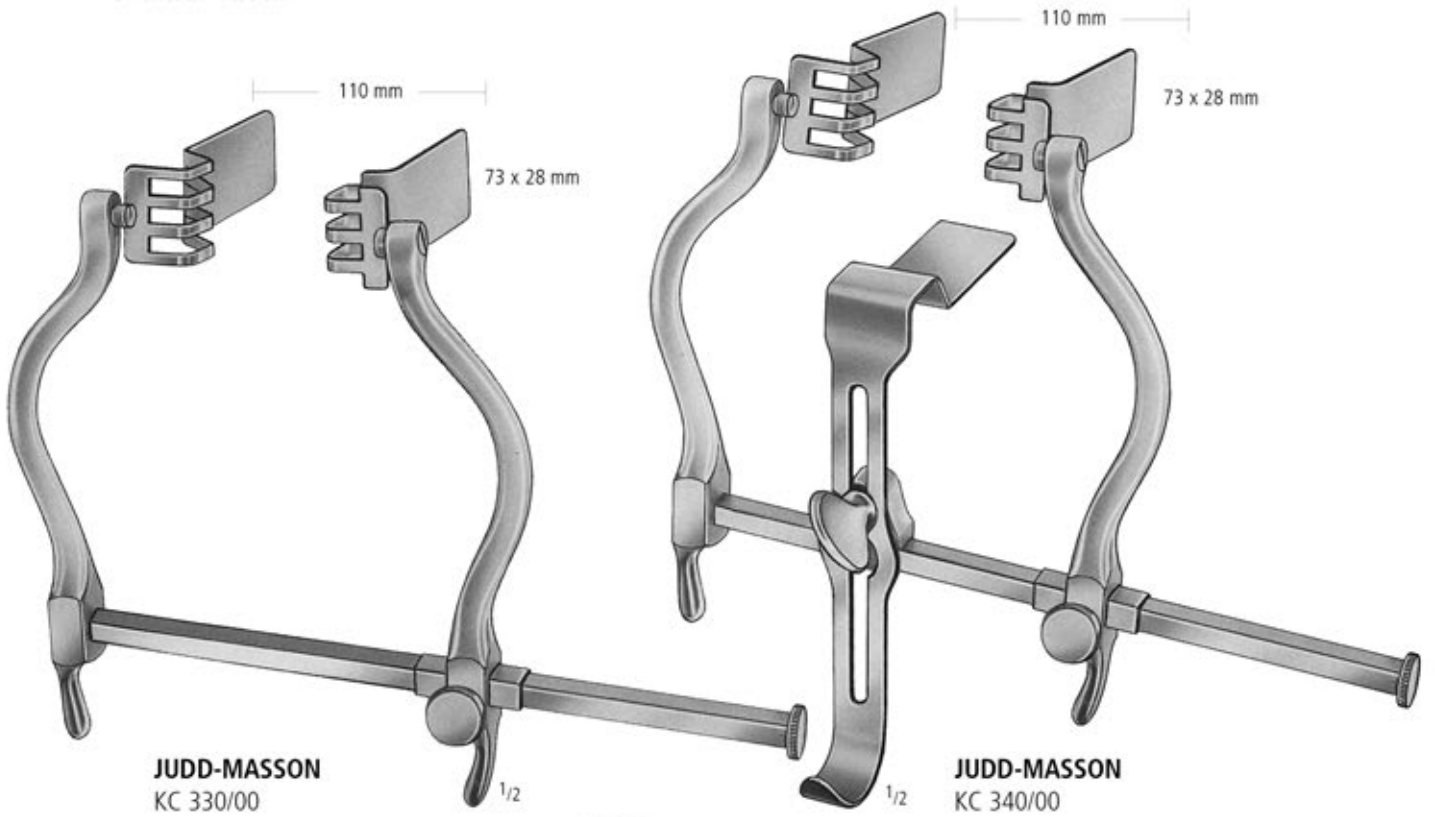

JUDD-MASSON
KC 330/00

JUDD-MASSON
KC 340/00

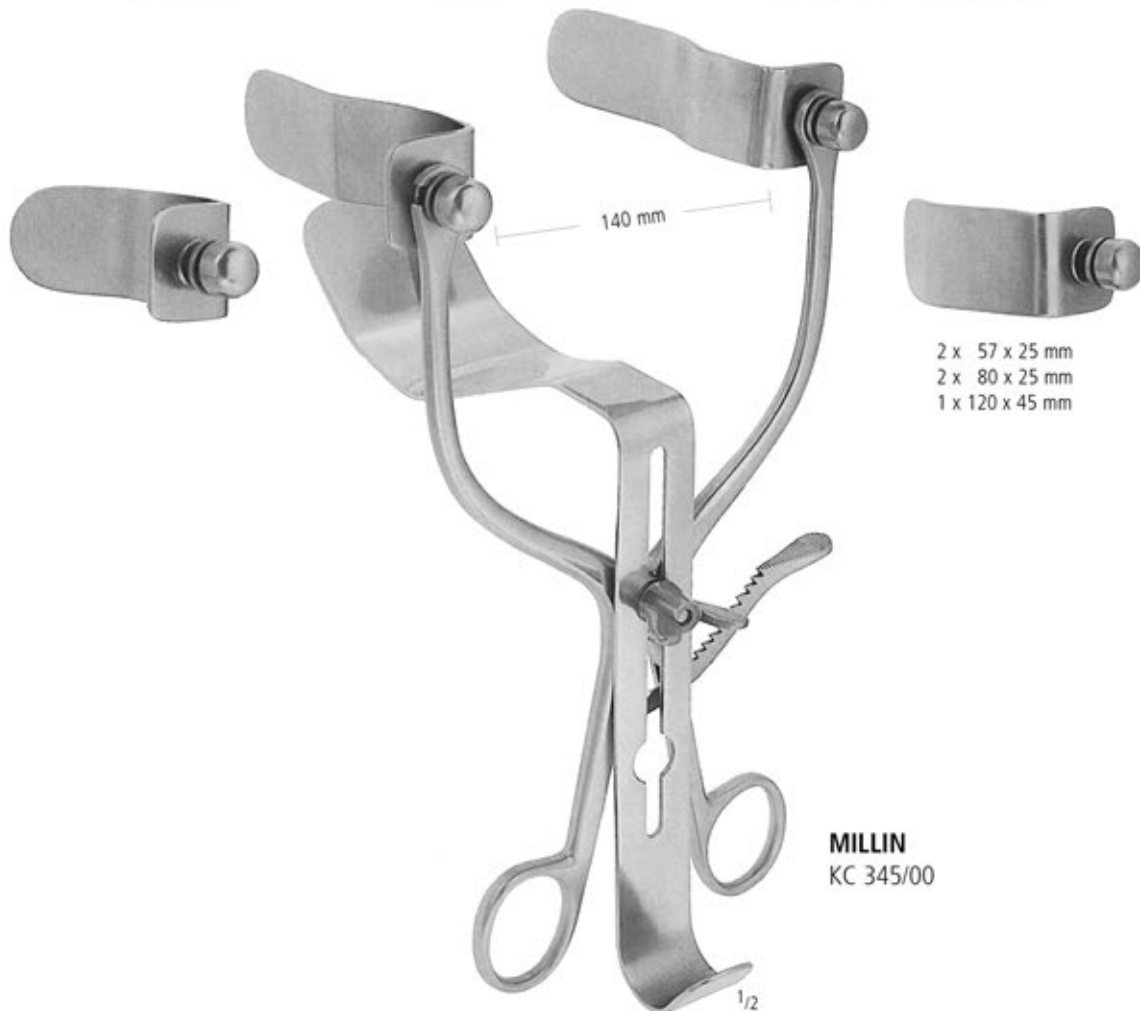

MILLIN
KC 345/00

Blasen-Wundspreizer, Blasenspatel
 Bladder Retractors
 Separadores vesicales
 Ecarteurs vésicaux, Spatules et Valves vésicales
 Divaricatori vescicali, Spatole e Divaricatori vescicali



HRYNTSCHAK
 KC 347/00
 komplett
 complete
 completo
 complet
 completo



LEGUEU
 KC 350/27
 27,0 cm/10³/₄"

KOCHER
 KC 357/26
 26,0 cm/10¹/₂"

AA
 AB
 AC
 AD
 AE
 AF
 AK
 AL
 AO
 AP
 AR
 KB
 KI
 KC
 KU
 KYE
 X



Einführungsinstrumente
 Catheter Introducing Instruments
 Instrumentos para introducir catéteres
 Mandrins pour sondes urétrales
 Mandrini per sonde uretrali

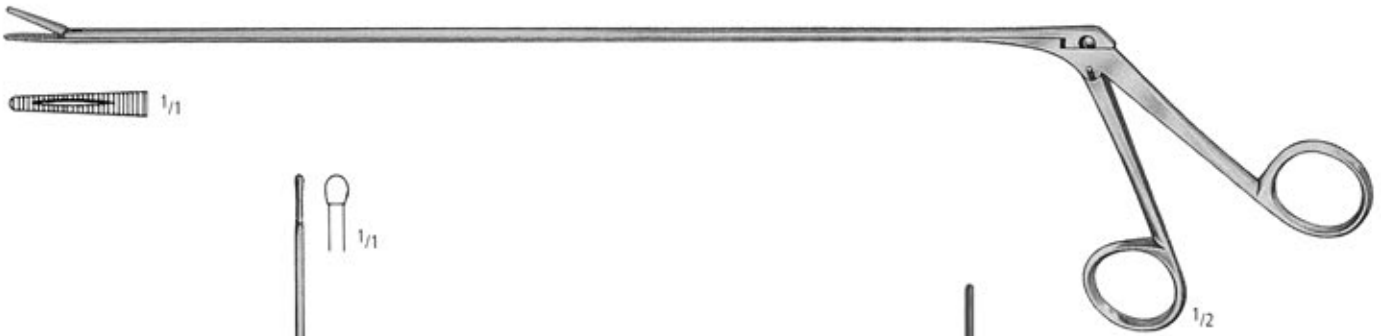

MATHIEU
 KC 420/20 20,0 cm/8"
 KC 420/28 28,0 cm/11"



GUYON
 KC 406/39
 39,0 cm/15¹/₃"

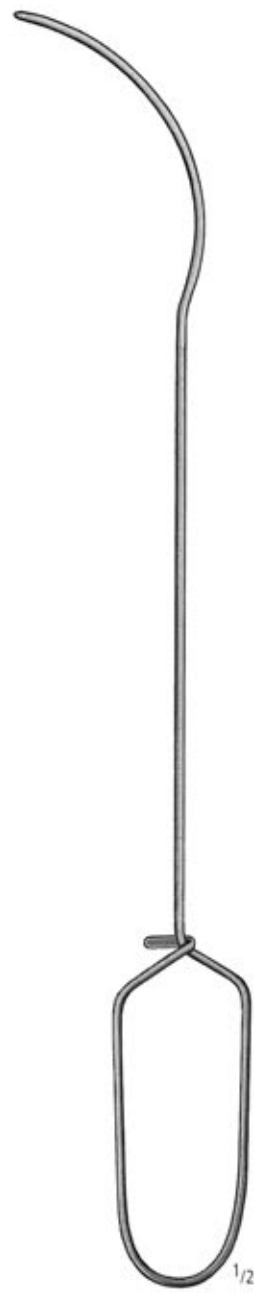

GUYON
 KC 407/35
 35,0 cm/14"

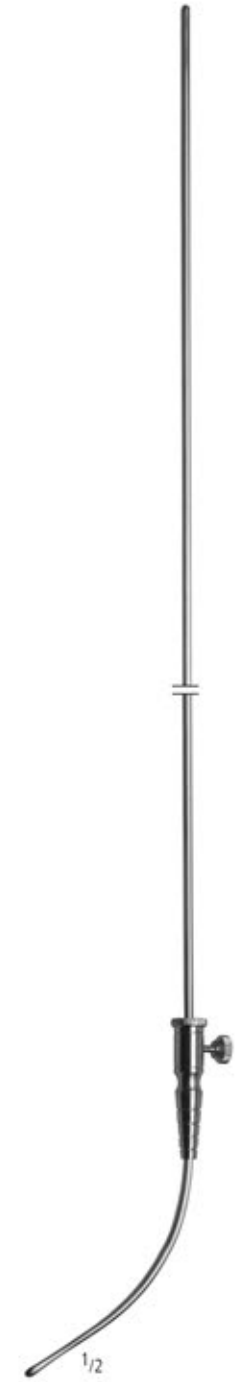

KC 408/46
 46,0 cm/18¹/₃"

UROLOGIE UROLOGY UROLOGIA UROLOGIE UROLOGIA

Urethrographie- und Circumcisions-Instrumente
 Urethrography- and Circumcision Instruments
 Instrumentos para uretrografia y circuncisión
 Instruments pour urétrographie et circoncision
 Strumenti per uretrografia e circoncisione



KC 442/15
 14,5 cm/5³/₄"



MOGEN
 KC 519/75
 7,5 cm/3"



KNUTSON Urethrographie - Instrument
 KC 520/00
 18,0 cm/7"



STOCKMANN
 KC 445/08
 8,0 cm/3"

Penisklemmen
 Penis Seizing Forceps
 Compresseur de l'urètre
 Compresores uretrales
 Serrapene

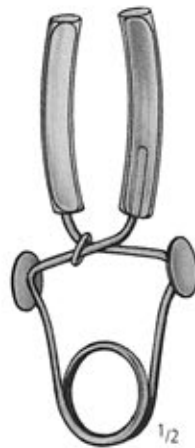

STRAUSS
 KC 449/11
 11,0 cm/4¹/₃"

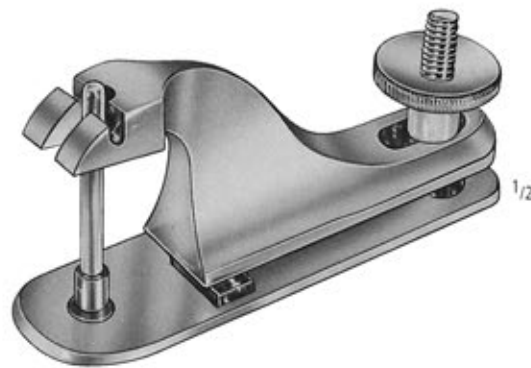

KC 530/08 - KC 530/32

mm Ø	
8	KC 530/08
11	KC 530/11
13	KC 530/13
16	KC 530/16
21	KC 530/21
26	KC 530/26
32	KC 530/32

AA
 AB
 AC
 AD
 AE
 AF
 AK
 AL
 AO
 AP
 AR
 KB
 KI
KC
 KU
 KYE
 X

Dilatationsbesteck
 Set of Dilating Sounds
 Juego de bujías dilatadoras
 Trousse de cathéters dilateurs
 Set di candelette dilatatrici

**GUYON**

KC 700/00
 420 x 175 x 40 mm

Besteck in Metalletui bestehend aus:

21 Bougies Guyon
 4 Gleitsonden

Set in metal case containing:

21 Bougies Guyon
 4 filiform Bougies

Juego en estuche de metal, conteniendo:

21 bujías Guyon
 4 bujías conductoras

Trousse en boîte métal, contenant:

21 bougies Guyon
 4 bougies conductrices

Set in scatola metallica, contente:

21 candelette Guyon
 4 candelette filiformi

Dilatationsbougies
 Dilating Bougies
 Bujías dilatadoras
 Bougies dilatatrices
 Candelette dilatatrici

mm Ø	charrière (french)	GUYON	VAN BUREN
2 ² / ₃	8		KC 720/08
3 ¹ / ₃	10	KC 710/10	KC 720/10
3 ² / ₃	11	KC 710/11	
4	12	KC 710/12	KC 720/12
4 ¹ / ₃	13	KC 710/13	
4 ² / ₃	14	KC 710/14	KC 720/14
5	15	KC 710/15	
5 ¹ / ₃	16	KC 710/16	KC 720/16
5 ² / ₃	17	KC 710/17	
6	18	KC 710/18	KC 720/18
6 ¹ / ₃	19	KC 710/19	
6 ² / ₃	20	KC 710/20	KC 720/20
7	21	KC 710/21	
7 ¹ / ₃	22	KC 710/22	KC 720/22
7 ² / ₃	23	KC 710/23	
8	24	KC 710/24	KC 720/24
8 ¹ / ₃	25	KC 710/25	
8 ² / ₃	26	KC 710/26	KC 720/26
9	27	KC 710/27	
9 ¹ / ₃	28	KC 710/28	KC 720/28
9 ² / ₃	29	KC 710/29	
10	30	KC 710/30	KC 720/30
10 ² / ₃	32		KC 720/32
11 ¹ / ₃	34		KC 720/34
12	36		KC 720/36



GUYON
 27,0 cm/10³/₄"

ohne Gewinde
 without thread
 sin rosca
 sans filet
 senza filetto



VAN BUREN
 28,0 cm/11"

AA
 AB
 AC
 AD
 AE
 AF
 AK
 AL
 AO
 AP
 AR
 KB
 KI
 KU
 KYE
 X

KC

Metall-Katheter
Metal Catheters
Sondas metálicas
Sondes métalliques
Sonde metalliche

für Männer
Male Catheters
para hombres
pour hommes
per uomini

für Frauen
Female Catheters
para mujeres
pour femmes
per donne

	mm Ø	
KC 750/06	2	KC 751/06
KC 750/07	2 ¹ / ₃	KC 751/07
KC 750/08	2 ² / ₃	KC 751/08
KC 750/09	3	KC 751/09
KC 750/10	3 ¹ / ₃	KC 751/10
KC 750/11	3 ² / ₃	KC 751/11
KC 750/12	4	KC 751/12
KC 750/13	4 ¹ / ₃	KC 751/13
KC 750/14	4 ² / ₃	KC 751/14
KC 750/15	5	KC 751/15
KC 750/16	5 ¹ / ₃	KC 751/16
KC 750/17	5 ² / ₃	KC 751/17
KC 750/18	6	KC 751/18
KC 750/19	6 ¹ / ₃	KC 751/19
KC 750/20	6 ² / ₃	KC 751/20
KC 750/21	7	KC 751/21
KC 750/22	7 ¹ / ₃	KC 751/22
KC 750/23	7 ² / ₃	KC 751/23
KC 750/24	8	KC 751/24

stainless steel



KC 750/06 -
KC 750/24
27,0 cm/10³/₄"



KC 751/06 -
KC 751/24
15,0 cm/6"

VERSCHIEDENES
VARIOUS ITEMS
DIVERSOS ARTICULOS
ARTICLES DIVERS
ARTICOLI DIVERSI

KU

nopa[®] instruments

Unser komplettes Programm Verschiedenes finden Sie in unserem Katalog „Allgemeines Instrumentarium“ in Gruppe KU.

For our complete range of Various Items kindly refer to our catalogue „General Instruments“, section KU.

Para nuestra gama completa de diversos artículos, por favor consulten nuestro catálogo de „Instrumental de uso general“, grupo KU.

Pour notre gamme complète d'articles divers, consultez notre catalogue „Instrumentation Générale“, section KU.

Per nostro assortimento completo di articoli diversi, consultare il nostro catalogo „Strumentazione Generale“, gruppo KU.





Ø x h		
75 x 75 mm	0,3 l	KU 290/03
80 x 85 mm	0,4 l	KU 290/04



Ø x h		
80 x 85 mm	0,4 l	KU 291/04
komplett mit Deckel		
complete with cap		



Ø x h		
60 x 60 mm	0,15 l	KU 295/10
85 x 50 mm	0,25 l	KU 295/11
85 x 85 mm	0,40 l	KU 295/12
85 x 125 mm	0,60 l	KU 295/13
100 x 50 mm	0,35 l	KU 295/14
100 x 100 mm	0,75 l	KU 295/15
120 x 120 mm	1,25 l	KU 295/16
150 x 100 mm	1,75 l	KU 295/17
150 x 150 mm	2,50 l	KU 295/18
200 x 100 mm	3,00 l	KU 295/19
200 x 200 mm	6,00 l	KU 295/20
komplett mit Deckel		
complete with cap		



Ø x h			
40 x 19 mm	0,05 l	KU 300/04	
61 x 30 mm	0,07 l	KU 300/06	
80 x 40 mm	0,14 l	KU 300/08	
116 x 50 mm	0,35 l	KU 300/11	
128 x 55 mm	0,45 l	KU 300/12	
147 x 65 mm	0,70 l	KU 300/14	



KU 301/01 = 0,25 l
KU 301/02 = 0,50 l
KU 301/03 = 1,00 l
KU 301/04 = 2,00 l



L = 170 mm	KU 302/17
L = 250 mm	KU 302/25
L = 275 mm	KU 302/27

AA

AB

AC

AD

AE

AF

AK

AL

AO

AP

AR

KB

KI

KC

KU

KYE

X



KU 303/65 →

KU 303/00
Ø = 65 mm



KU 304/50 = 50 x 25 x 4,5 mm
KU 304/65 = 65 x 42 x 8,0 mm
KU 304/75 = 75 x 25 x 4,5 mm



KU 306/15 = 150 x 95 x 13 mm

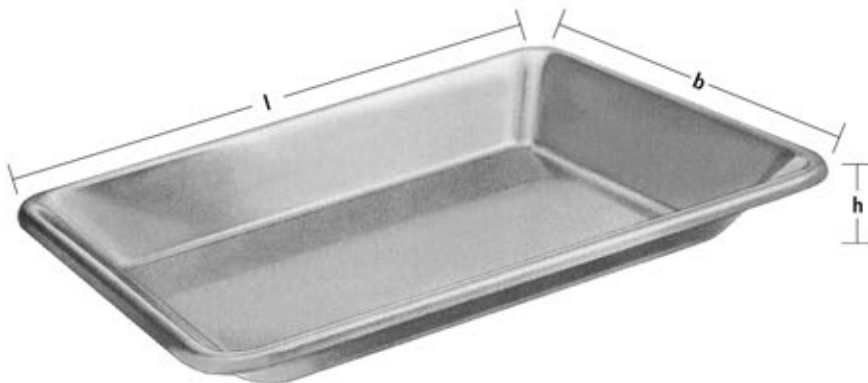

l x b x h

230 x 155 x 30 mm
 300 x 175 x 30 mm
 300 x 175 x 40 mm
 350 x 240 x 36 mm
 400 x 300 x 50 mm

KU 307/23
 KU 307/30
 KU 308/30
 KU 308/35
 KU 308/50

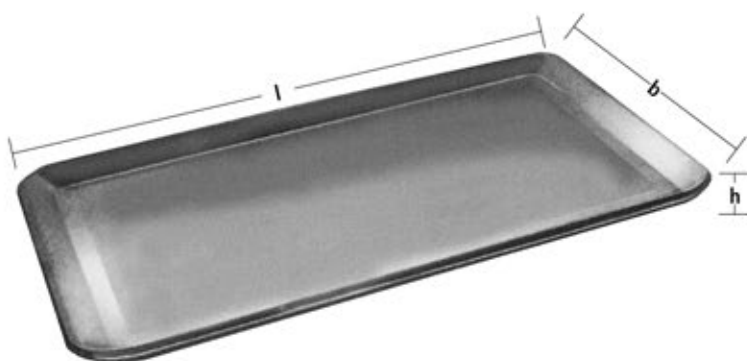

l x b x h

210 x 160 x 10 mm
 240 x 180 x 10 mm
 310 x 150 x 10 mm
 310 x 210 x 10 mm
 350 x 240 x 10 mm
 400 x 270 x 20 mm
 420 x 280 x 10 mm

KU 309/21
 KU 309/24
 KU 309/31
 KU 310/31
 KU 310/35
 KU 310/40
 KU 310/42

AA
 AB
 AC
 AD
 AE
 AF
 AK
 AL
 AO
 AP
 AR
 KB
 KI
 KC
 KU
 KYE
 X

KU



Ø x h	l	
165 x 60 mm	0,75	KU 311/16
175 x 70 mm	1,00	KU 311/17
220 x 80 mm	2,00	KU 311/22
225 x 90 mm	2,50	KU 311/23
240 x 110 mm	3,00	KU 311/24
275 x 115 mm	4,50	KU 311/27
290 x 125 mm	6,00	KU 311/29
310 x 120 mm	6,00	KU 311/31
345 x 125 mm	8,50	KU 311/34
380 x 130 mm	11,00	KU 311/38



l x b x h	
16,5 x 9,0 x 3,5 cm	KU 312/16
20,0 x 10,0 x 5,0 cm	KU 312/20
22,0 x 15,0 x 5,0 cm	KU 312/22
26,0 x 15,0 x 5,0 cm	KU 312/26
30,5 x 20,5 x 5,0 cm	KU 312/30
30,0 x 15,0 x 5,0 cm	KU 312/31
50,0 x 20,0 x 10,0 cm	KU 312/50
50,0 x 20,0 x 12,0 cm	KU 312/51

Deckel ohne Knopf
Lid without knob
Tapa sin botón
Couvercle sans bouton
Coperchio senza pomolo

l x b x h	
16,5 x 9,0 x 3,5 cm	KU 313/16
20,0 x 10,0 x 5,0 cm	KU 313/20
22,0 x 15,0 x 5,0 cm	KU 313/22
26,0 x 15,0 x 5,0 cm	KU 313/26
30,5 x 20,5 x 5,0 cm	KU 313/30
30,0 x 15,0 x 5,0 cm	KU 313/31
50,0 x 20,0 x 10,0 cm	KU 313/50
50,0 x 20,0 x 12,0 cm	KU 313/51

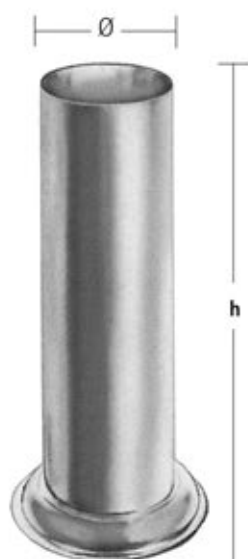

Ø x h	
30 x 90 mm	KU 314/09
50 x 100 mm	KU 314/10
50 x 130 mm	KU 314/13
50 x 175 mm	KU 314/17
75 x 100 mm	KU 315/10
75 x 130 mm	KU 315/13
75 x 175 mm	KU 315/17



KU 316/10
350 x 270 x 100 mm



Ø 235 mm KU 316/23
Ø 310 mm KU 316/31



KU 316/42
230 x 120 mm
männlich / male



KU 316/43
220 x 135 mm
weiblich / female

AA
AB
AC
AD
AE
AF
AK
AL
AO
AP
AR
KB
KI
KC
KU
KYE
X

container system
container system
sistema de contenedor
système de conteneur
sistema del contenitore

KYE

nopa[®] instruments

Unser komplettes Container Programm finden Sie in unserem Katalog „Container System“.

For our complete range of sterilizing containers kindly refer to our catalogue „Container system“.

Para nuestro gama completa de contenedores, por favor consulte nuestro catálogo de „Sistema de contenedor“.

Pour notre gamme complet des conteneurs, consultez notre catalogue „Système de conteneur“.

Per nostro assortimento completo di contenitore, consultare il nostro catalogo „Sistema del Contenitore“.



Bitte beachten Sie die Erklärung und Gebrauchsanweisung ab Seite 361

Please follow the explanation and instructions from page 373

Por favor, tenga en cuenta la explicación e instrucción de uso de la página 385

Per favore, osservate la spiegazione e l'istruzione per l'uso a partire dalla pagina 397



Erklärung zu unseren Symbolen • Explanation of our symbols • Explicación de nuestros símbolos
 • Explication de nos figures • Spiegazione dei nostri simboli

Wanne • Bottom • Fondo • Fond • Fondo



Wanne nicht gelocht
 Bottom not perforated
 Fondo no perforado
 Fond non poinçonné
 Fondo non perforato



Wanne gelocht
 Bottom perforated
 Fondo perforado
 Fond poinçonné
 Fondo perforato

Deckel • Lid • Tapa • Couvercle • Coperchio



Deckel gelocht
 Lid perforated
 Tapa perforada
 Couvercle poinçonné
 Coperchio perforato



Sicherheitsdeckel
 Safety lid
 Tapa de seguridad
 Couvercle de sécurité
 Coperchio di sicurezza



Deckel nicht gelocht
 Lid not perforated
 Tapa no perforada
 Couvercle non poinçonné
 Coperchio non perforato

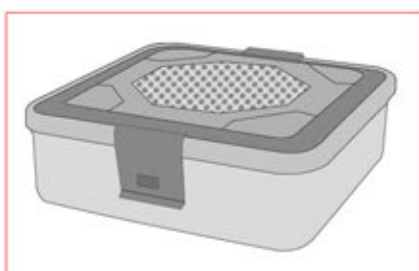

Zur Verwendung mit Sterilisationscontainern
 For use with sterilization containers
 Por uso con contenedores de esterilización
 Pour l'usage avec des conteneurs de sterilisation
 Per l'uso con contenitori di sterilizzazione

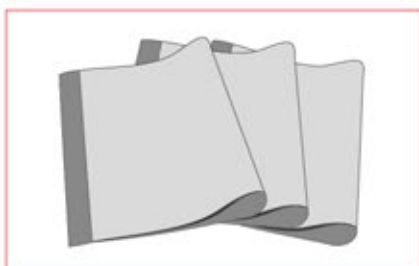

Zur Verwendung mit Weichverpackung
 For the use with soft packaging materials
 Por uso con envase blando
 Pour l'usage avec des emballages mous
 Per l'uso con imballaggio blando

1/2 Container

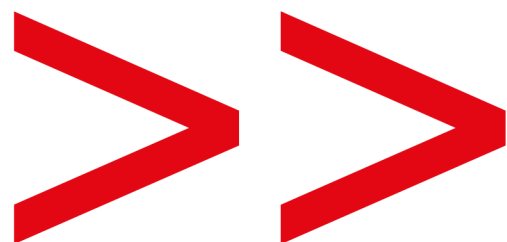



Nur Deckel farbig
Lid colored only
Solamente tapas en diferentes colores
Couvercle de couleur seulement
Solo coperchio colorato

L(mm)	B(mm)	H(mm)						
285	280	100	KYE 200/01	KYE 200/02	KYE 200/03	KYE 200/04	KYE 200/05	KYE 200/06
285	280	135	KYE 200/11	KYE 200/12	KYE 200/13	KYE 200/14	KYE 200/15	KYE 200/16
285	280	150	KYE 200/21	KYE 200/22	KYE 200/23	KYE 200/24	KYE 200/25	KYE 200/26
285	280	200	KYE 200/31	KYE 200/32	KYE 200/33	KYE 200/34	KYE 200/35	KYE 200/36
285	280	260	KYE 200/41	KYE 200/42	KYE 200/43	KYE 200/44	KYE 200/45	KYE 200/46



Nur Deckel farbig
Lid colored only
Solamente tapas en diferentes colores
Couvercle de couleur seulement
Solo coperchio colorato

L(mm)	B(mm)	H(mm)						
285	280	100	KYE 204/01	KYE 204/02	KYE 204/03	KYE 204/04	KYE 204/05	KYE 204/06
285	280	135	KYE 204/11	KYE 204/12	KYE 204/13	KYE 204/14	KYE 204/15	KYE 204/16
285	280	150	KYE 204/21	KYE 204/22	KYE 204/23	KYE 204/24	KYE 204/25	KYE 204/26
285	280	200	KYE 204/31	KYE 204/32	KYE 204/33	KYE 204/34	KYE 204/35	KYE 204/36
285	280	260	KYE 204/41	KYE 204/42	KYE 204/43	KYE 204/44	KYE 204/45	KYE 204/46

Wanne gelocht
Bottom perforated
Fondo perforado
Fond poinçonné
Fondo perforato



Wanne nicht gelocht
Bottom not perforated
Fondo no perforado
Fond non poinçonné
Fondo non perforato



L(mm) B(mm) H(mm)

285	280	100	KYE 284/10
285	280	135	KYE 284/13
285	280	150	KYE 284/15
285	280	200	KYE 284/20
285	280	260	KYE 284/26

L(mm) B(mm) H(mm)

285	280	100	KYE 286/10
285	280	135	KYE 286/13
285	280	150	KYE 286/15
285	280	200	KYE 286/20
285	280	260	KYE 286/26

Deckel gelocht
Lid perforated
Tapa perforada
Couvercle poinçonné
Coperchio perforato



L(mm) B(mm)

285 280



KYE 280/01 KYE 280/02 KYE 280/03 KYE 280/04 KYE 280/05 KYE 280/06

Sicherheitsdeckel
Safety lid
Tapa de seguridad
Couvercle de sécurité
Coperchio di sicurezza



L(mm) B(mm)

285 280



KYE 281/01 KYE 281/02 KYE 281/03 KYE 281/04 KYE 281/05 KYE 281/06

Deckel nicht gelocht
Lid not perforated
Tapa no perforada
Couvercle non poinçonné
Coperchio non perforato



L(mm) B(mm)

285 280



KYE 289/01 KYE 289/02 KYE 289/03 KYE 289/04 KYE 289/05 KYE 289/06



L(mm)	B(mm)	H(mm)	
255	245	30	SK 105/03
255	245	50	SK 105/05
255	245	70	SK 105/07
255	245	100	SK 105/10



L(mm)	B(mm)	
255	245	SK 105/50





L(mm)	B(mm)
255	255

SK 105/61



L(mm)	B(mm)	H(mm)
255	255	30

SK 105/62



L(mm)	B(mm)	H(mm)
255	245	130

SK 105/71



Lochblechsiebkorb
 Perforated steel basket
 Cestilla de acero perforado
 Panier d'acier poinçonné
 Cestello d'acciaio perforato

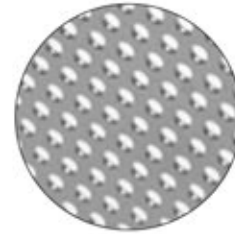

Aufsatz für Lochblechsiebkorb
 Body extension for perforated steel basket
 Borde complementario para cestilla de acero perforado
 Bordure pour panier d'acier poinçonné
 Bordo rialzato per cestello d'acciaio perforato



L(mm) B(mm) H(mm)
 240 250 60 SK 110/06

L(mm) B(mm) H(mm)
 240 250 60 SK 110/16



Siebdeckel
 Top for basket
 Tapa para cestilla
 Couvercle pour panier
 Copericho per cestello

Siebrahmen
 Bottom for basket
 Fondo para cestilla
 Fond pour panier
 Fondo per cestello

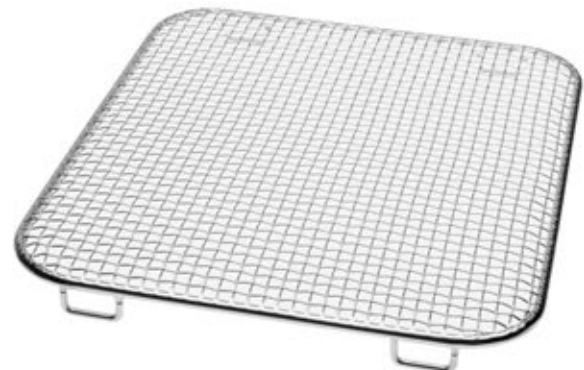
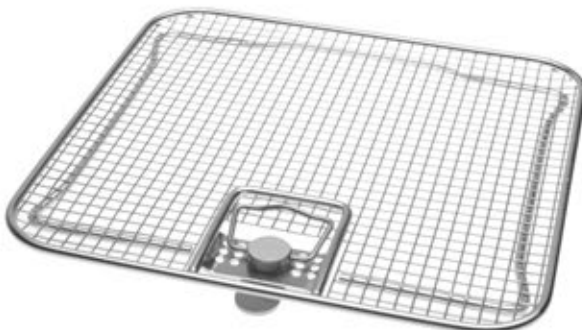

L(mm) B(mm)
 240 250 SK 110/50

L(mm) B(mm)
 240 250 SK 110/71





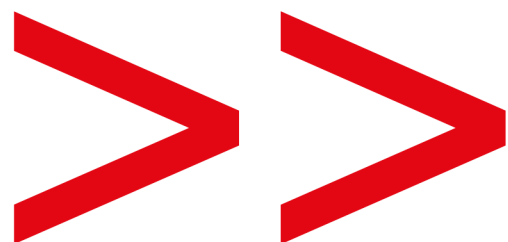



3/4 Container

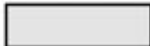









Nur Deckel farbig
Lid colored only
Solamente tapas en diferentes colores
Couvercle de couleur seulement
Solo coperchio colorato

L(mm)	B(mm)	H(mm)						
465	280	100	KYE 202/01	KYE 202/02	KYE 202/03	KYE 202/04	KYE 202/05	KYE 202/06
465	280	135	KYE 202/11	KYE 202/12	KYE 202/13	KYE 202/14	KYE 202/15	KYE 202/16
465	280	150	KYE 202/21	KYE 202/22	KYE 202/23	KYE 202/24	KYE 202/25	KYE 202/26



Nur Deckel farbig
Lid colored only
Solamente tapas en diferentes colores
Couvercle de couleur seulement
Solo coperchio colorato

L(mm)	B(mm)	H(mm)						
465	280	100	KYE 205/01	KYE 205/02	KYE 205/03	KYE 205/04	KYE 205/05	KYE 205/06
465	280	135	KYE 205/11	KYE 205/12	KYE 205/13	KYE 205/14	KYE 205/15	KYE 205/16
465	280	150	KYE 205/21	KYE 205/22	KYE 205/23	KYE 205/24	KYE 205/25	KYE 205/26

Wanne gelocht
Bottom perforated
Fondo perforado
Fond poinçonné
Fondo perforato



L(mm)	B(mm)	H(mm)	
465	280	100	KYE 282/10
465	280	135	KYE 282/13
465	280	150	KYE 282/15

Wanne nicht gelocht
Bottom not perforated
Fondo no perforado
Fond non poinçonné
Fondo non perforato



L(mm)	B(mm)	H(mm)	
465	280	100	KYE 283/10
465	280	135	KYE 283/13
465	280	150	KYE 283/15

Deckel gelocht
Lid perforated
Tapa perforada
Couvercle poinçonné
Coperchio perforato



L(mm)	B(mm)
465	280



KYE 280/61 KYE 280/62 KYE 280/63 KYE 280/64 KYE 280/65 KYE 280/66

Sicherheitsdeckel
Safety lid
Tapa de seguridad
Couvercle de sécurité
Coperchio di sicurezza



L(mm)	B(mm)
465	280



KYE 281/61 KYE 281/62 KYE 281/63 KYE 281/64 KYE 281/65 KYE 281/66

Deckel nicht gelocht
Lid not perforated
Tapa no perforada
Couvercle non poinçonné
Coperchio non perforato



L(mm)	B(mm)
465	280



KYE 289/61 KYE 289/62 KYE 289/63 KYE 289/64 KYE 289/65 KYE 289/66

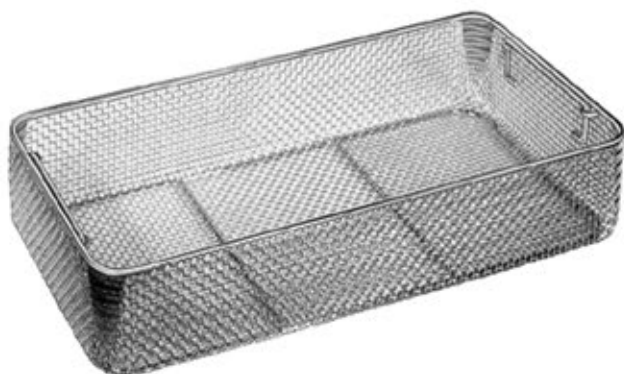

L(mm)	B(mm)	H(mm)	
405	255	30	SK 205/03
405	255	50	SK 205/05
405	255	70	SK 205/07
405	255	100	SK 205/10



L(mm)	B(mm)	
405	255	SK 205/50



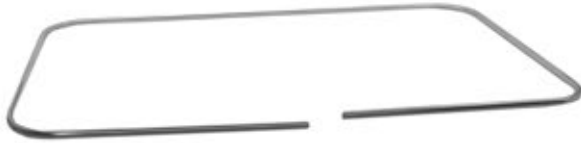

L(mm)	B(mm)
405	255

SK 205/61

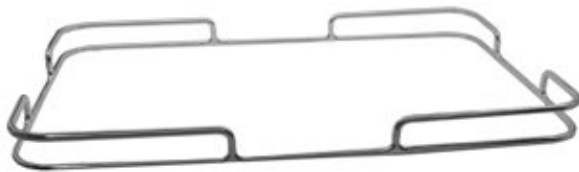

L(mm)	B(mm)	H(mm)
405	255	30

SK 205/62



L(mm)	B(mm)	H(mm)
405	250	130

SK 205/71



L(mm)	B(mm)	H(mm)
405	250	130

SK 205/72

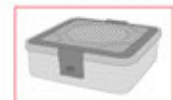

Lochblechsiebkorb
 Perforated steel basket
 Cestilla de acero perforado
 Panier d'acier poinçonné
 Cestello d'acciaio perforato



L(mm)	B(mm)	H(mm)	
410	250	60	SK 210/06



L(mm)	B(mm)	
410	250	SK 210/50



1/1 Container

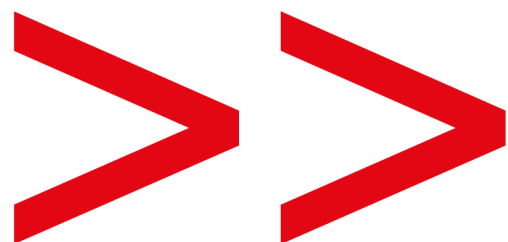



Nur Deckel farbig
Lid colored only
Solamente tapas en diferentes colores
Couvercle de couleur seulement
Solo coperchio colorato

L(mm)	B(mm)	H(mm)						
580	280	100	KYE 200/51	KYE 200/52	KYE 200/53	KYE 200/54	KYE 200/55	KYE 200/56
580	280	135	KYE 200/61	KYE 200/62	KYE 200/63	KYE 200/64	KYE 200/65	KYE 200/66
580	280	150	KYE 200/71	KYE 200/72	KYE 200/73	KYE 200/74	KYE 200/75	KYE 200/76
580	280	200	KYE 200/81	KYE 200/82	KYE 200/83	KYE 200/84	KYE 200/85	KYE 200/86
580	280	260	KYE 200/91	KYE 200/92	KYE 200/93	KYE 200/94	KYE 200/95	KYE 200/96



Nur Deckel farbig
Lid colored only
Solamente tapas en diferentes colores
Couvercle de couleur seulement
Solo coperchio colorato

L(mm)	B(mm)	H(mm)						
580	280	100	KYE 204/51	KYE 204/52	KYE 204/53	KYE 204/54	KYE 204/55	KYE 204/56
580	280	135	KYE 204/61	KYE 204/62	KYE 204/63	KYE 204/64	KYE 204/65	KYE 204/66
580	280	150	KYE 204/71	KYE 204/72	KYE 204/73	KYE 204/74	KYE 204/75	KYE 204/76
580	280	200	KYE 204/81	KYE 204/82	KYE 204/83	KYE 204/84	KYE 204/85	KYE 204/86
580	280	260	KYE 204/91	KYE 204/92	KYE 204/93	KYE 204/94	KYE 204/95	KYE 204/96

Wanne gelocht
Bottom perforated
Fondo perforado
Fond poinçonné
Fondo perforato





Wanne nicht gelocht
Bottom not perforated
Fondo no perforado
Fond non poinçonné
Fondo non perforato



L(mm)	B(mm)	H(mm)		L(mm)	B(mm)	H(mm)	
580	280	100	KYE 285/10	580	280	100	KYE 287/10
580	280	135	KYE 285/13	580	280	135	KYE 287/13
580	280	150	KYE 285/15	580	280	150	KYE 287/15
580	280	200	KYE 285/20	580	280	200	KYE 287/20
580	280	260	KYE 285/26	580	280	260	KYE 287/26

Deckel gelocht
Lid perforated
Tapa perforada
Couvercle poinçonné
Coperchio perforato



L(mm)	B(mm)					
580	280					
		KYE 280/51	KYE 280/52	KYE 280/53	KYE 280/54	KYE 280/55
						
						KYE 280/56

Sicherheitsdeckel
Safety lid
Tapa de seguridad
Couvercle de sécurité
Coperchio di sicurezza



L(mm)	B(mm)					
580	280					
		KYE 281/51	KYE 281/52	KYE 281/53	KYE 281/54	KYE 281/55
						
						KYE 281/56

Deckel nicht gelocht
Lid not perforated
Tapa no perforada
Couvercle non poinçonné
Coperchio non perforato



L(mm)	B(mm)					
580	280					
		KYE 289/51	KYE 289/52	KYE 289/53	KYE 289/54	KYE 289/55
						
						KYE 289/56

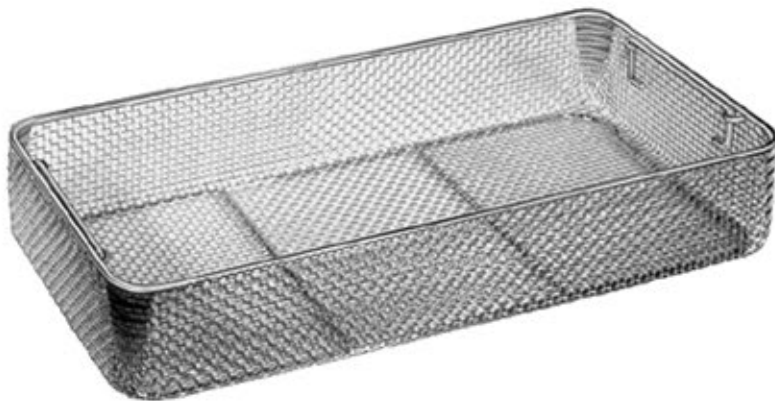

L(mm)	B(mm)	H(mm)	
485	255	30	SK 305/03
485	255	50	SK 305/05
485	255	70	SK 305/07
485	255	100	SK 305/10
540	255	30	SK 307/03
540	255	50	SK 307/05
540	255	70	SK 307/07
540	255	100	SK 307/10

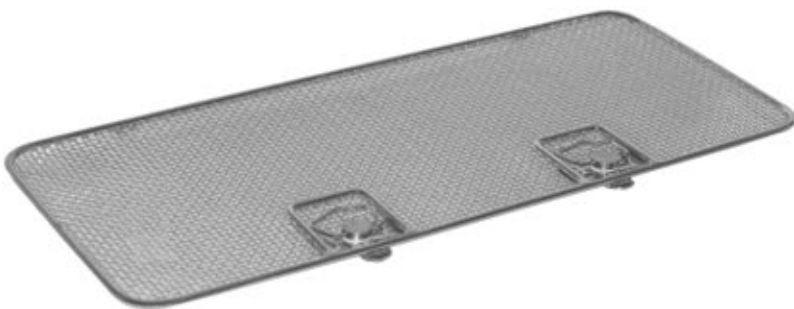

L(mm)	B(mm)	
485	255	SK 305/50
540	255	SK 307/50





L(mm) B(mm)

545 255

SK 307/61



L(mm) B(mm) H(mm)

545 255 30

SK 307/62



L(mm) B(mm) H(mm)

510 250 130

SK 307/71

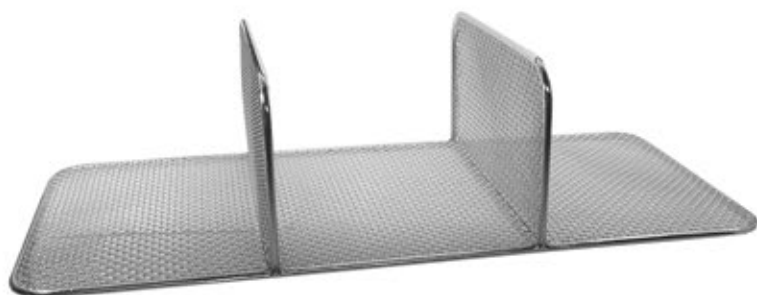

L(mm) B(mm) H(mm)

510 250 130

SK 307/72



Lochblechsiebkorb
 Perforated steel basket
 Cestilla de acero perforado
 Panier d'acier poinçonné
 Cestello d'acciaio perforato



L(mm) B(mm) H(mm)
 480 250 60 SK 310/06



Aufsatz für Lochblechsiebkorb
 Body extension for perforated steel basket
 Borde complementario para cestilla de acero perforado
 Bordure pour panier d'acier poinçonné
 Bordo rialzato per cestello d'acciaio perforato



L(mm) B(mm) H(mm)
 480 250 100 SK 310/16



Siebdeckel
 Top for basket
 Tapa para cestilla
 Couvercle pour panier
 Coperchio per cestello

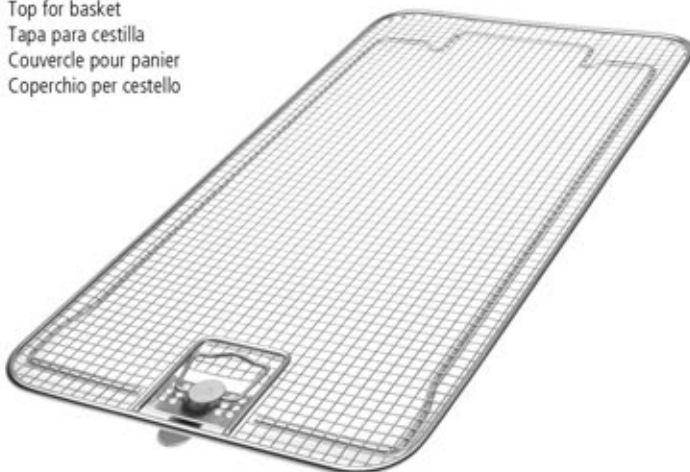

L(mm) B(mm)
 480 250 SK 310/50



Siebrahmen
 Bottom for basket
 Fondo para cestilla
 Fond pour panier
 Fondo per cestello



L(mm) B(mm)
 480 250 SK 310/71



ENDOSCOPY

nopa[®] instruments



GYNÄKOLOGIE - HYSTEROSKOPIE
GYNECOLOGY - HYSTEROSCOPY
GINECOLOGIA - HISTEROSCOPIA
GYNECOLOGIE - HYSTEROSCOPIE
GINECOLOGIA - ISTEROSCOPIA

12

nopa[®] instruments

GYNECOLOGY



Urologie und Hysteroskopie
 Urology and Hysteroscopy
 Urología y Histeroscopia
 Urologie et Hysteroscopie
 Urologia e Isteroscopia

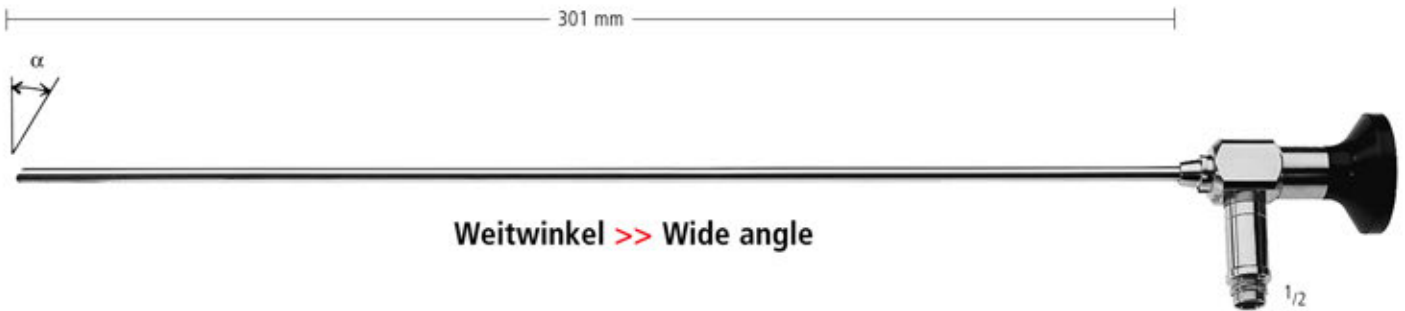

Weitwinkel >> Wide angle

Ø mm	$\alpha = 0^\circ$	$\alpha = 12^\circ$	$\alpha = 30^\circ$	$\alpha = 70^\circ$
2,7	XP 720/20		XP 720/23	
4,0	XP 720/40	XP 720/42	XP 720/43	XP 720/47

>> autoklavierbar
autoclavable

>> mit Anschluss für
with adaptors for

Storz
Wolf
ACMI

Hysteroskopie
Hysteroscopy
Histeroscopia
Hysteroscopie
Isteroscopia

schäfte - sheaths



Universal 0° / 30°

for endoscopes Ø 4,0 mm Ø 8 mm XP 800/07



**Dauerspülschaft
Continuous flow sheath**

for endoscopes	Ø 2,7 mm	Ø 6 mm / 0°	XP 803/60
		Ø 6 mm / 30°	XP 803/63
for endoscopes	Ø 4,0 mm	Ø 8 mm / 0°	XP 803/80
		Ø 8 mm / 30°	XP 803/83



for endoscopes	Ø 2,7 mm	Ø 3 mm / 0°	XP 800/03
		Ø 3 mm / 30°	XP 805/03
for endoscopes	Ø 4,0 mm	Ø 5 mm / 0°	XP 805/00
		Ø 5 mm / 30°	XP 805/05



	Ø 2,7 mm	XP 808/27
	Ø 4,0 mm	XP 808/40

Urologie und Hysteroskopie
 Urology and Hysteroscopy
 Urología y Histeroscopia
 Urologie et Hysteroscopie
 Urologia e Isteroscopia

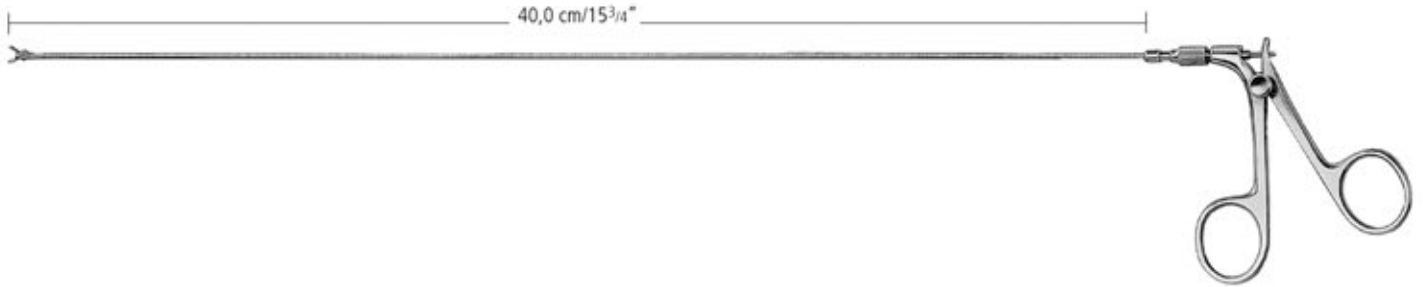

		1/1	Ø 5 CH Ø 7 CH	XK 935/20 XK 935/40
		1/1	Ø 5 CH Ø 7 CH	XK 935/21 XK 935/41
semi rigid		1/1	Ø 5 CH Ø 7 CH	XK 935/22 XK 935/42
		1/1	Ø 5 CH Ø 7 CH	XK 936/20 XK 936/40
		1/1	Ø 5 CH Ø 7 CH	XK 936/21 XK 936/41
semi rigid		1/1	Ø 5 CH Ø 7 CH	XK 936/22 XK 936/42
		1/1	Ø 5 CH Ø 7 CH	XK 937/20 XK 937/40
		1/1	Ø 5 CH Ø 7 CH	XK 937/21 XK 937/41
semi rigid		1/1	Ø 5 CH Ø 7 CH	XK 937/22 XK 937/42

Transurethrale Resektion - Hysteroskopie
 Transurethral resection - Hysteroscopy
 Resección transuretral - Histeroscopia
 Résection transurétrale - Hysteroscopie
 Resezione transureterale - Isteroscopia

>> Resektoskop mit Dauerspülschaft, drehbar
 >> Resectoscope with continuous flow shaft, rotating

>> passiv schneidend
 >> passive cutting

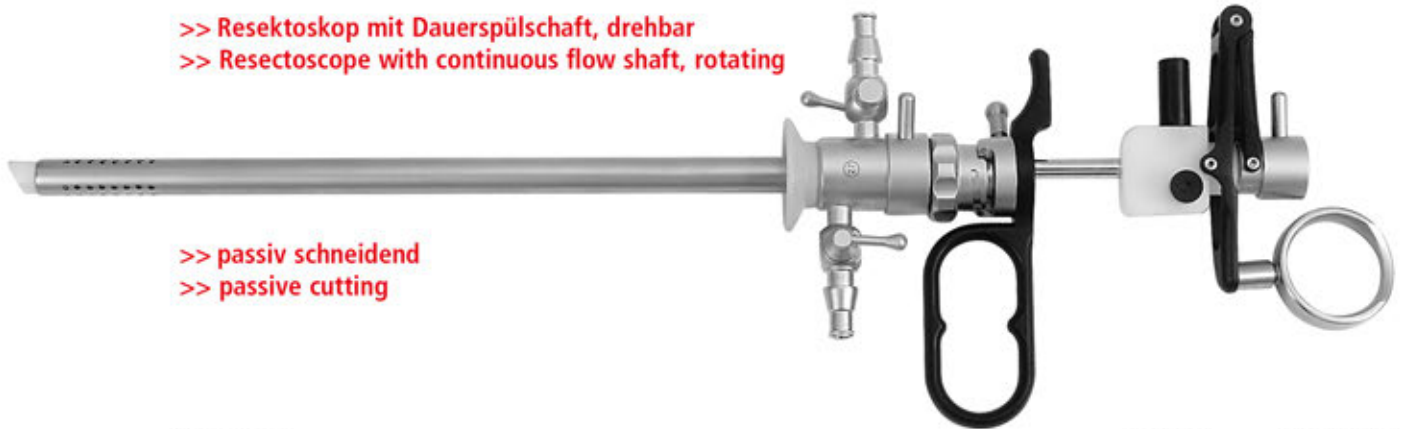

XM 500/10
 Arbeitselement, allein
 Working element, only

Ø 27 CH XM 500/00
 komplett
 complete
 completo
 complet
 completo



>> drehbar
 >> rotatable

Ø 24 CH XM 501/24



XM 502/00



>> drehbar
 >> rotatable

Ø 27 CH XM 503/27

Transurethrale Resektion - Hysteroskopie
 Transurethral resection - Hysteroscopy
 Resección transuretral - Histeroscopia
 Résection transurétrale - Hysteroscopie
 Resezione transureterale - Isteroscopia

>> Resektoskop mit Dauerspülschaft, drehbar
 >> Resectoscope with continuous flow shaft, rotating

>> aktiv schneidend
 >> active cutting

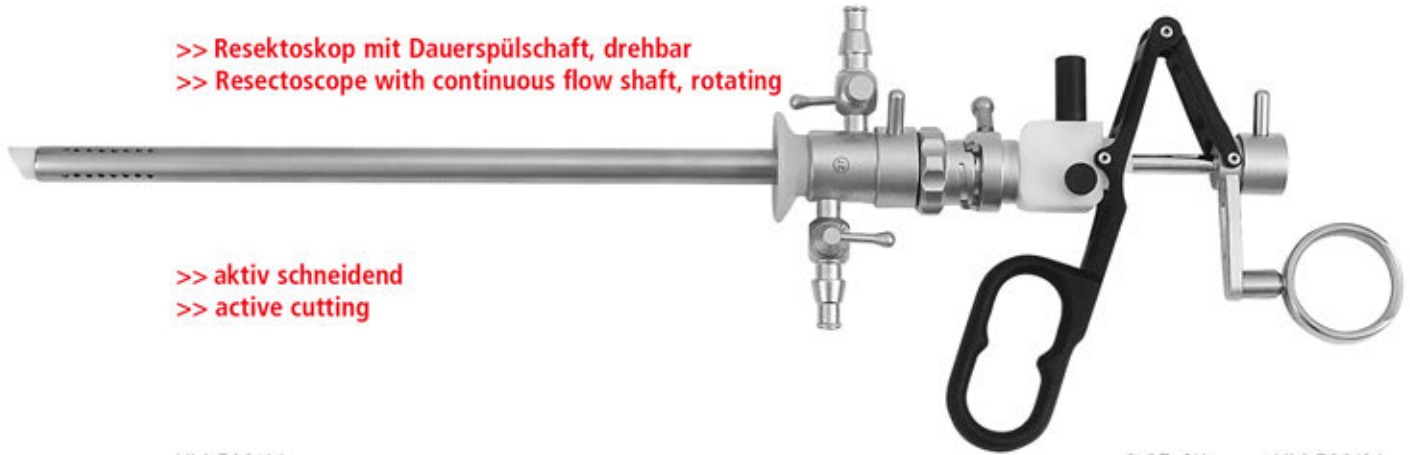

XM 500/11
 Arbeitselement, allein
 Working element, only

Ø 27 CH XM 500/01
 komplett
 complete
 completo
 completo
 complet
 completo



>> drehbar
 >> rotatable

Ø 24 CH XM 501/24



XM 502/00



>> drehbar
 >> rotatable

Ø 27 CH XM 503/27

Transurethrale Resektion - Hysteroskopie
 Transurethral resection - Hysteroscopy
 Resección transuretral - Histeroscopia
 Résection transurétrale - Hysteroscopie
 Resezione transureterale - Isteroscopia

>> Resektoskop mit Dauerspülschaft, starr
 >> Resectoscope with continuous flow shaft, rigid



>> aktiv schneidend
 >> active cutting

XM 500/11
 Arbeitselement, allein
 Working element, only

Ø 27 CH XM 500/02
 komplett
 complete
 completo
 complet
 completo



>> starr
 >> rigid

Ø 24 CH XM 505/24



XM 502/00



>> starr
 >> rigid

Ø 27 CH XM 507/27

Transurethrale Resektion - Hysteroskopie
 Transurethral resection - Hysteroscopy
 Resección transuretral - Histeroscopia
 Résection transurétrale - Hysteroscopie
 Resezione transureterale - Isteroscopia

>> Resektoskop mit Dauerspülschaft, starr
 >> Resectoscope with continuous flow shaft, rigid

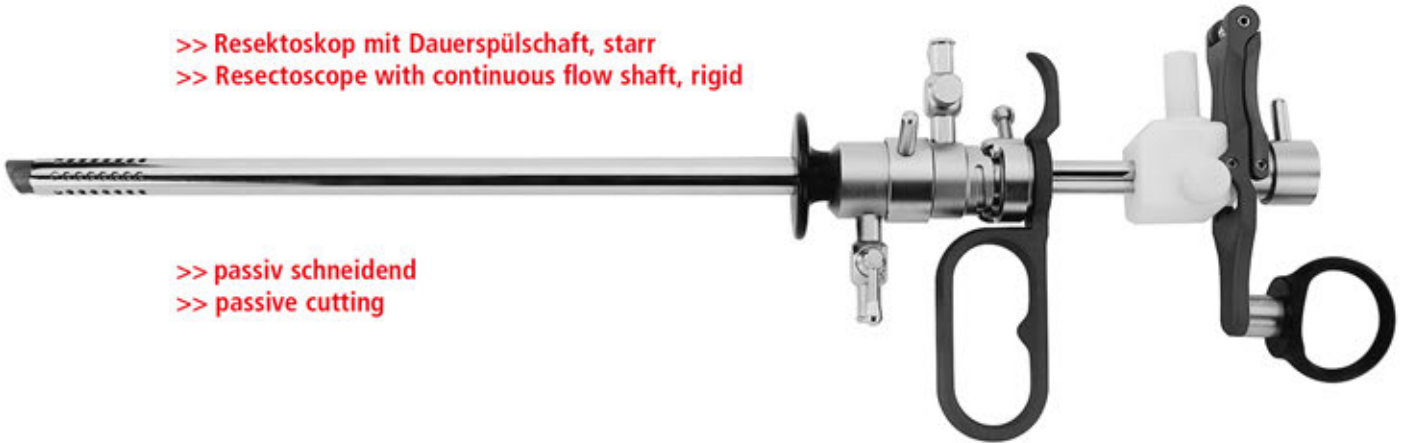

>> passiv schneidend
 >> passive cutting

XM 500/10
 Arbeitselement, allein
 Working element, only

Ø 27 CH XM 500/03
 komplett
 complete
 completo
 complet
 completo



>> starr
 >> rigid

Ø 24 CH XM 505/24



XM 502/00



>> starr
 >> rigid

Ø 27 CH XM 507/27

Transurethrale Resektion
 Transurethral resection
 Resección transuretral
 Résection transurétrale
 Resezione transureterale



Resektoskopschaft mit zwei Hähnen
resectoscope sheath with two stopcocks

Ø 24 CH XM 501/25



Standard Obturator
standard obturator

Ø 24 CH XM 502/00



Krümmbarer Obturator
deflecting obturator

Ø 24 CH XM 502/01



Sichtobturator
visual obturator

Ø 24 CH XM 502/02

Elektroden
Electrodes
Electrodos
Electrodes
Elettrodi

Ø 24 CH Schneide- und Koagulationselektroden
Ø 24 CH Cutting and coagulation electrodes



Messer
Knife

XM 510/01



XM 510/02



XM 510/03



XM 510/04



3 mm
5 mm

XM 512/02
XM 512/12



3 mm
5 mm

XM 512/03
XM 512/13

Endoskopie, Pelviskopie
 Endoscopy, Pelviscopy
 Endoscopia, Pelviscopia
 Endoscopie, Pelviscopie
 Endoscopia, Pelviscopia



COHEN
 XM 518/00

mit zwei Aufsätzen
 with two cones



XM 518/01



XM 518/02



XM 519/00

komplett
 complete
 completo
 complet
 completo



XM 519/01



XM 519/02

UROLOGIE
UROLOGY
UROLOGÍA
UROLOGIE
UROLOGIA

12

nopa[®] instruments

UROLOGY



Urologie
Urology
Urologia
Urologie
Urologia

Kinder
children
niños
enfants
bambini



12

18

20

22

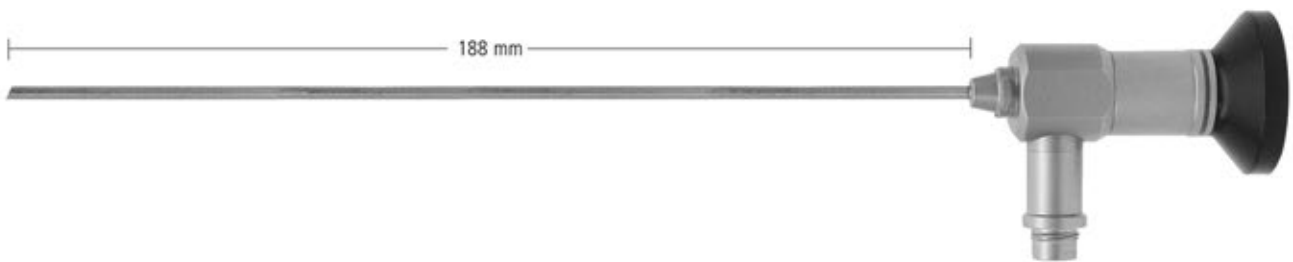

Ø mm	$\alpha = 0^\circ$	$\alpha = 30^\circ$
2,7	XP 715/30	XP 715/33

>> autoklavierbar
autoclavable

>> mit Anschluss für
with adaptors for

Storz
Wolf
ACMI

Transurethrale Resektion
 Transurethral resection
 Resección transuretral
 Résection transurétrale
 Resezione transureterale

Kinder
 children
 niños
 enfants
 bambini



Resektoskop für Kinder, passiv
Resectoscope for children, passive

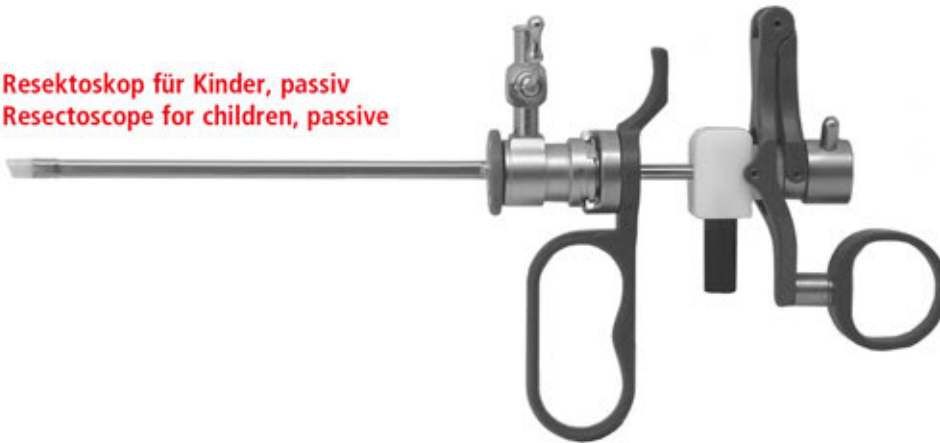

Ø 11 CH
 Ø 13 CH

XM 490/11
 XM 490/13
 komplett
 complete
 completo
 complet
 completo

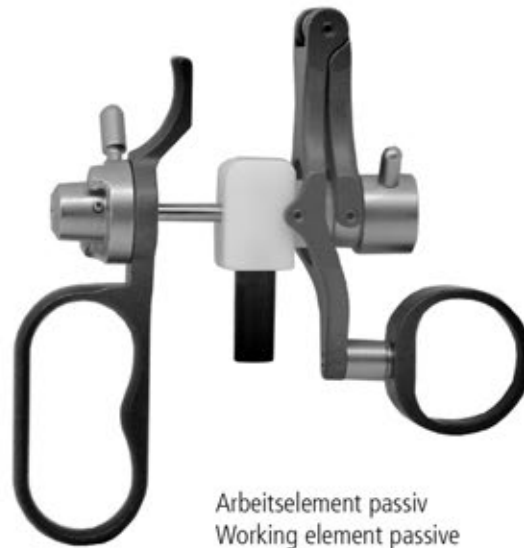

Arbeitselement passiv
 Working element passive

XM 490/10



mit Obturator
 with obturator

Ø 11 CH
 Ø 13 CH

XM 493/11
 XM 493/13

Elektroden
Electrodes
Electrodos
Electrodes
Elettrodi

Kinder
children
niños
enfants
bambini



XM 513/01



XM 513/02



XM 513/03



XM 513/04

Zystoskopie Schäfte
Cystoscopy sheaths
Vainas de citoscopia
Tiges cytoscopie
Citoscopia flange

Kinder
children
niños
enfants
bambini

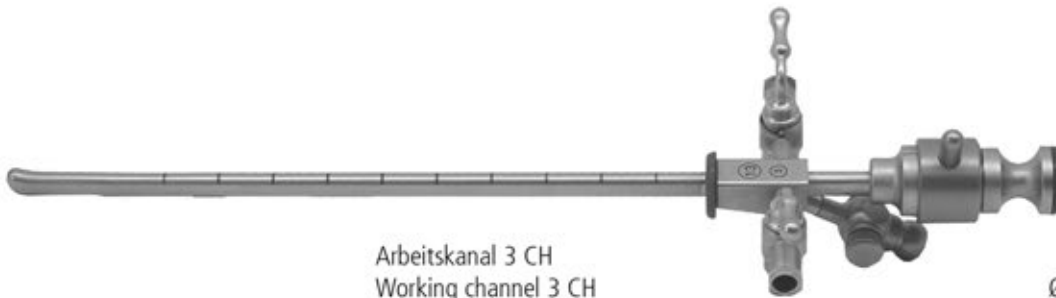

Arbeitskanal 3 CH
Working channel 3 CH

Ø 13 CH XP 830/13



ALBARRAN

XP 839/01



XP 844/00

Urologie
Urology
Urologia
Urologie
Urologia

Kinder
children
niños
enfants
bambini



12

18

20

22

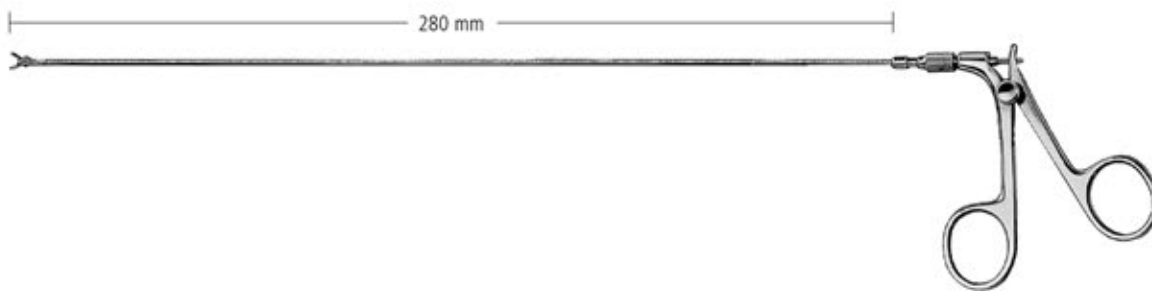

Ø 3 CH XK 935/10



Ø 3 CH XK 936/10

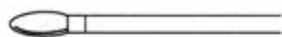

Ø 3 CH XP 850/33



Ø 3 CH XP 850/43

Optisches Urethrotom
Optical urethrotome
Uretrótomu óptico
Urétrótome optique
Uretrotomo vista

Kinder
children
niños
enfants
bambini



Optisches Urethrotom für Kinder, passiv
Optical urethrotome for children, passive



Ø 13 CH

XP 860/00
komplett
complete
completo
complet
completo

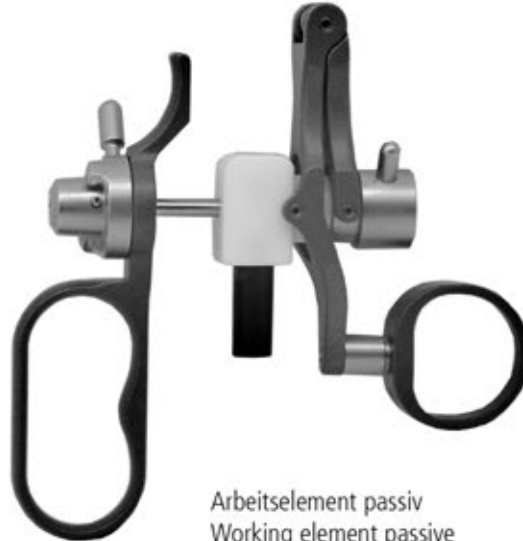

Arbeitselement passiv
Working element passive

XM 490/10



mit Obturator
with obturator

Ø 13 CH

XP 864/13

Kaltmesser für optisches Urethrotom
 Cold knife for optical uretherotome
 Criobisturí para uretrótomu óptico
 Couteau froid pour urétrotome optique
 Bisturi a freddo per uretrotomo ottico

Kinder
 children
 niños
 enfants
 bambini



12

18

20

22



XP 869/01



XP 869/02



XP 869/03



XP 869/04

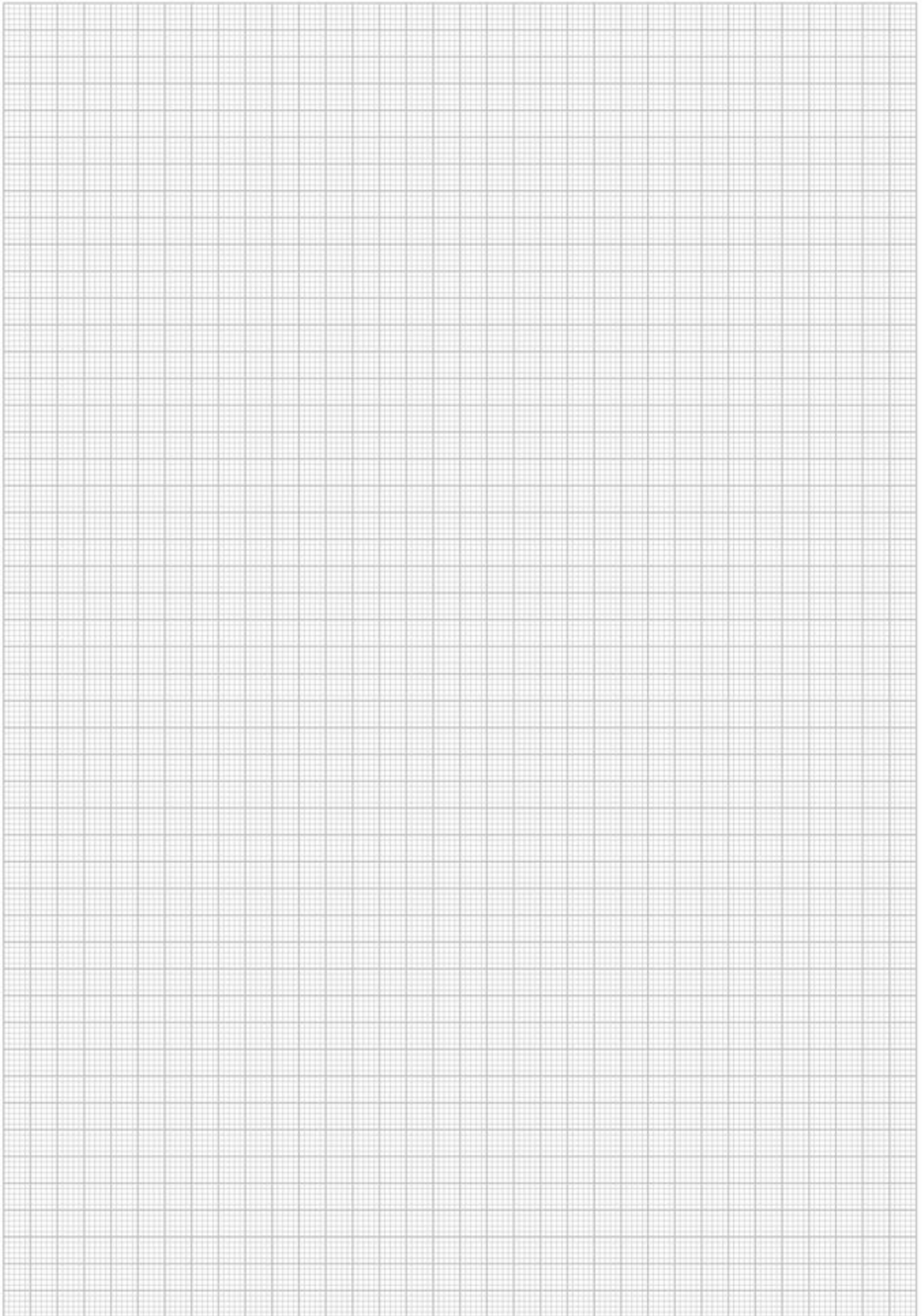

Urologie und Hysteroskopie
 Urology and Hysteroscopy
 Urología y Histeroscopia
 Urologie et Hysteroscopie
 Urologia e Isteroscopia

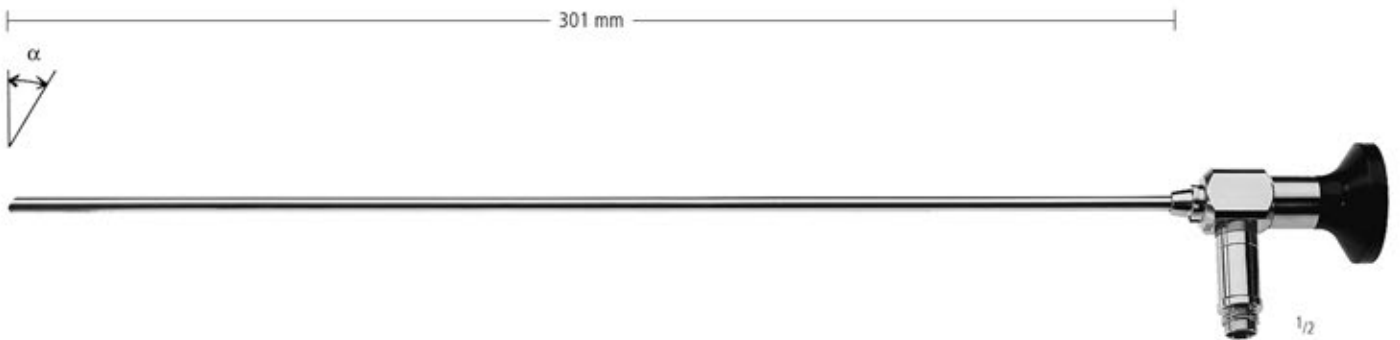

Weitwinkel >> Wide angle

Ø mm	$\alpha = 0^\circ$	$\alpha = 12^\circ$	$\alpha = 30^\circ$	$\alpha = 70^\circ$
2,7	XP 720/20		XP 720/23	
4,0	XP 720/40	XP 720/42	XP 720/43	XP 720/47

>> autoklavierbar
 autoclavable

>> mit Anschluss für
 with adaptors for

Storz
 Wolf
 ACMI

Transurethrale Resektion - Hysteroskopie
 Transurethral resection - Hysteroscopy
 Resección transuretral - Histeroscopia
 Résection transurétrale - Hysteroscopie
 Resezione transureterale - Isteroscopia

>> Resektoskop mit Dauerspülschaft, drehbar
 >> Resectoscope with continuous flow shaft, rotating

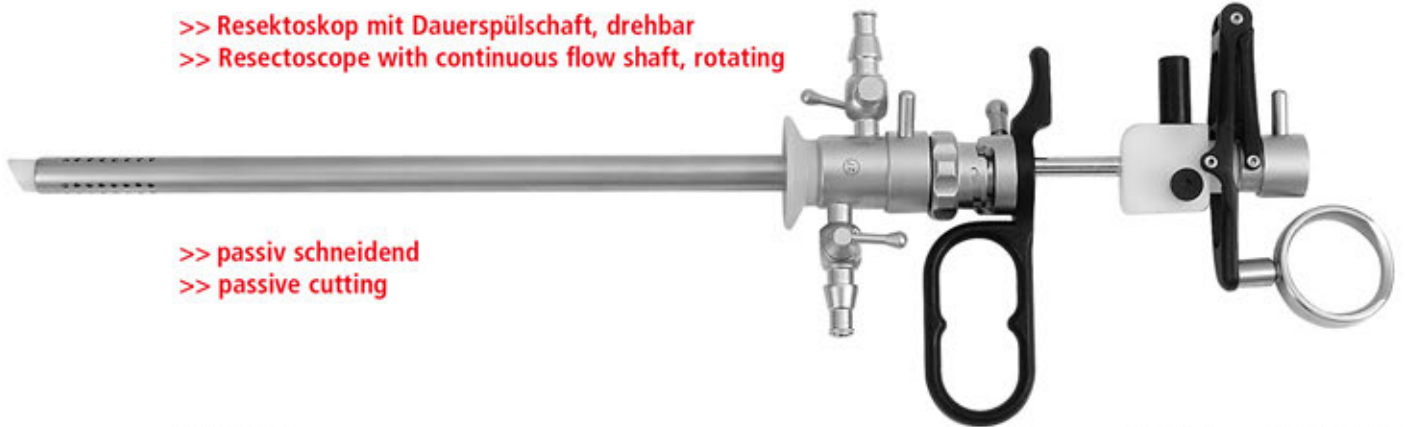

>> passiv schneidend
 >> passive cutting

XM 500/10
 Arbeitselement, allein
 Working element, only

Ø 27 CH XM 500/00
 komplett
 complete
 completo
 completo
 complet
 completo



>> drehbar
 >> rotatable

Ø 24 CH XM 501/24



XM 502/00



>> drehbar
 >> rotatable

Ø 27 CH XM 503/27

Transurethrale Resektion - Hysteroskopie
 Transurethral resection - Hysteroscopy
 Resección transuretral - Histeroscopia
 Résection transurétrale - Hysteroscopie
 Resezione transureterale - Isteroscopia

>> Resektoskop mit Dauerspülschaft, drehbar
 >> Resectoscope with continuous flow shaft, rotating

>> aktiv schneidend
 >> active cutting

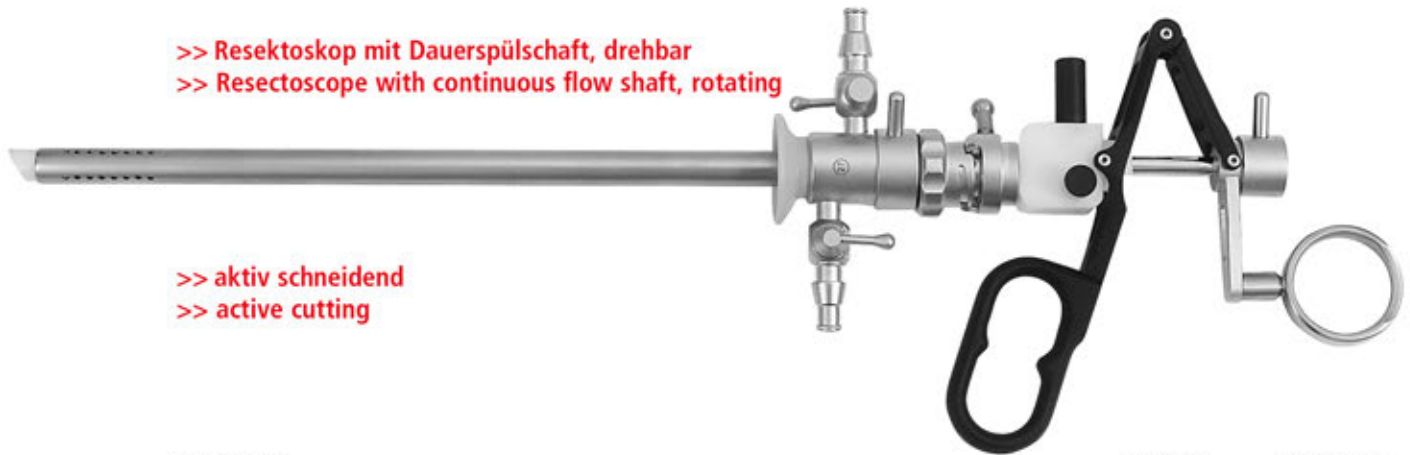

XM 500/11
 Arbeitselement, allein
 Working element, only

Ø 27 CH XM 500/01
 komplett
 complete
 completo
 complet
 completo



>> drehbar
 >> rotatable

Ø 24 CH XM 501/24



XM 502/00



>> drehbar
 >> rotatable

Ø 27 CH XM 503/27

Transurethrale Resektion - Hysteroskopie
 Transurethral resection - Hysteroscopy
 Resección transuretral - Histeroscopia
 Résection transurétrale - Hysteroscopie
 Resezione transureterale - Isteroscopia

>> Resektoskop mit Dauerspülschaft, starr
 >> Resectoscope with continuous flow shaft, rigid



>> aktiv schneidend
 >> active cutting

XM 500/11
 Arbeitselement, allein
 Working element, only

Ø 27 CH XM 500/02
 komplett
 complete
 completo
 complet
 completo



>> starr
 >> rigid

Ø 24 CH XM 505/24



XM 502/00



>> starr
 >> rigid

Ø 27 CH XM 507/27

Transurethrale Resektion - Hysteroskopie
 Transurethral resection - Hysteroscopy
 Resección transuretral - Histeroscopia
 Résection transurétrale - Hysteroscopie
 Resezione transureterale - Isteroscopia

>> Resektoskop mit Dauerspülschaft, starr
 >> Resectoscope with continuous flow shaft, rigid

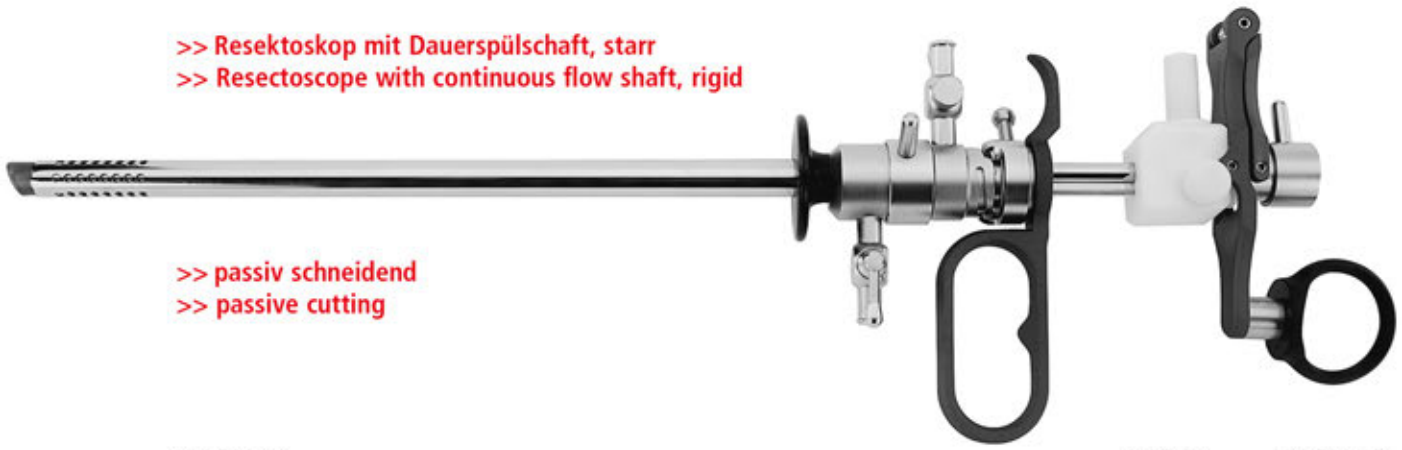

>> passiv schneidend
 >> passive cutting

XM 500/10
 Arbeitselement, allein
 Working element, only

Ø 27 CH XM 500/03
 komplett
 complete
 completo
 complet
 completo



>> starr
 >> rigid

Ø 24 CH XM 505/24



XM 502/00



>> starr
 >> rigid

Ø 27 CH XM 507/27

Elektroden
Electrodes
Electrodos
Electrodes
Elettrodi

Ø 24 CH Schneide- und Koagulationselektroden
Ø 24 CH Cutting and coagulation electrodes



Messer
Knife

XM 510/01



XM 510/02



XM 510/03



XM 510/04



3 mm
5 mm

XM 512/02
XM 512/12



3 mm
5 mm

XM 512/03
XM 512/13

Anschlusskabel
 Connection cords
 Cables de connexion
 Câbles de raccordement
 Cavi da connessione

monopolar

resectoscope
 500/01

XM 500/00

XM



1/1

MARTIN / BERCHTOLD / AESCULAP

300 cm XR 824/03
 500 cm XR 824/05



1/1

STORZ / ERBE

300 cm XR 824/13
 500 cm XR 824/15



1/1

VALLEYLAB

300 cm XR 824/23
 500 cm XR 824/25

Transurethrale Resektion
 Transurethral resection
 Resección transuretral
 Résection transurétrale
 Resezione transureterale



Resektoskopschaft mit zwei Hähnen
resectoscope sheath with two stopcocks

Ø 24 CH XM 501/25



Standard Obturator
standard obturator

Ø 24 CH XM 502/00



Krümmbarer Obturator
deflecting obturator

Ø 24 CH XM 502/01



Sichtobturator
visual obturator

Ø 24 CH XM 502/02

Zystoskopie Schäfte
 Cystoscopy sheaths
 Vainas de citoscopia
 Tiges cytoscopie
 Citoscopia flange

schäfte - sheaths

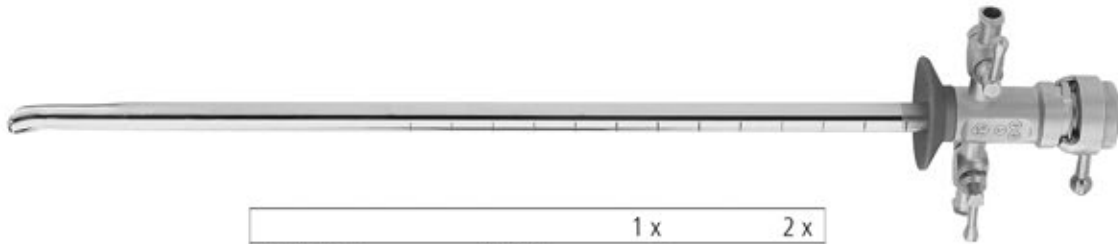

		1 x	2 x
XP 830/17	17 CH	5	-
XP 830/19	19 CH	5	4
XP 830/21	21 CH	7	5
XP 830/23	23 CH	9	6
XP 830/25	25 CH	10	7

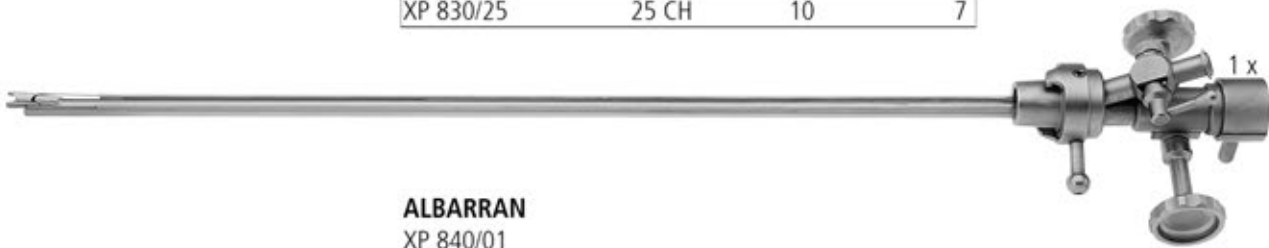

ALBARRAN
 XP 840/01



ALBARRAN
 XP 840/02



XP 845/00



XP 845/01



XP 845/02



ENDOSKOPIE ENDOSCOPY ENDOSCOPIA ENDOSCOPIE ENDOSCOPIA

Urologie und Hysteroskopie
 Urology and Hysteroscopy
 Urología y Histeroscopia
 Urologie et Hysteroscopie
 Urologia e Isteroscopia



		1/1	Ø 5 CH Ø 7 CH	XK 935/20 XK 935/40
		1/1	Ø 5 CH Ø 7 CH	XK 935/21 XK 935/41
semi rigid		1/1	Ø 5 CH Ø 7 CH	XK 935/22 XK 935/42
		1/1	Ø 5 CH Ø 7 CH	XK 936/20 XK 936/40
		1/1	Ø 5 CH Ø 7 CH	XK 936/21 XK 936/41
semi rigid		1/1	Ø 5 CH Ø 7 CH	XK 936/22 XK 936/42
		1/1	Ø 5 CH Ø 7 CH	XK 937/20 XK 937/40
		1/1	Ø 5 CH Ø 7 CH	XK 937/21 XK 937/41
semi rigid		1/1	Ø 5 CH Ø 7 CH	XK 937/22 XK 937/42

Optisches Urethrotom
 Optical urethrotome
 Uretrótopo óptico
 Urétrótome optique
 Uretrótomo ottico

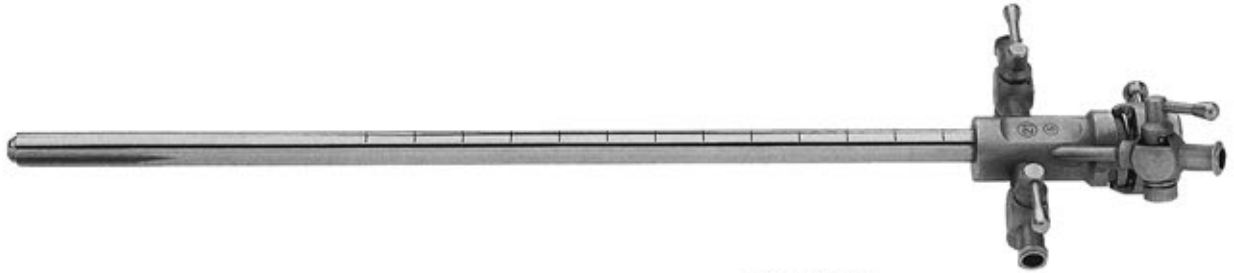

mit Obturator
 with obturator

Ø 21 CH

XP 865/01



XM 500/10



XP 865/03

Kaltmesser für optisches Urethrotom
Cold knife for optical urethrotome
Criobisturi para uretrótopo óptico
Couteau froid pour urétrótome optique
Bisturi a freddo per uretrotomo ottico

12

18

20

22



XP 870/01



XP 870/02



XP 870/03

Optische Zangen
 Optical Forceps
 Pinzas ópticas
 Pincas optiques
 Pinze ottiche

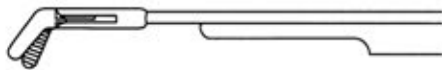

XP 875/01



XP 875/02



XP 875/03



XP 875/04



XP 875/05

Urologie
Urology
Urologia
Urologie
Urologia



ELLIK Evakuator

XP 880/00
komplett
complete
completo
complet
completo



REINER-ALEXANDER

Aufsatz für Blasenkatheter
Tip for vesicle-catheter



XP 881/50



XP 881/01	50cc
XP 881/02	75cc
XP 881/03	100cc
XP 881/04	150cc
XP 881/05	200cc



XP 881/11
XP 881/12
XP 881/13
XP 881/14
XP 881/15



Ersatz-Zylinder
Spare barrel

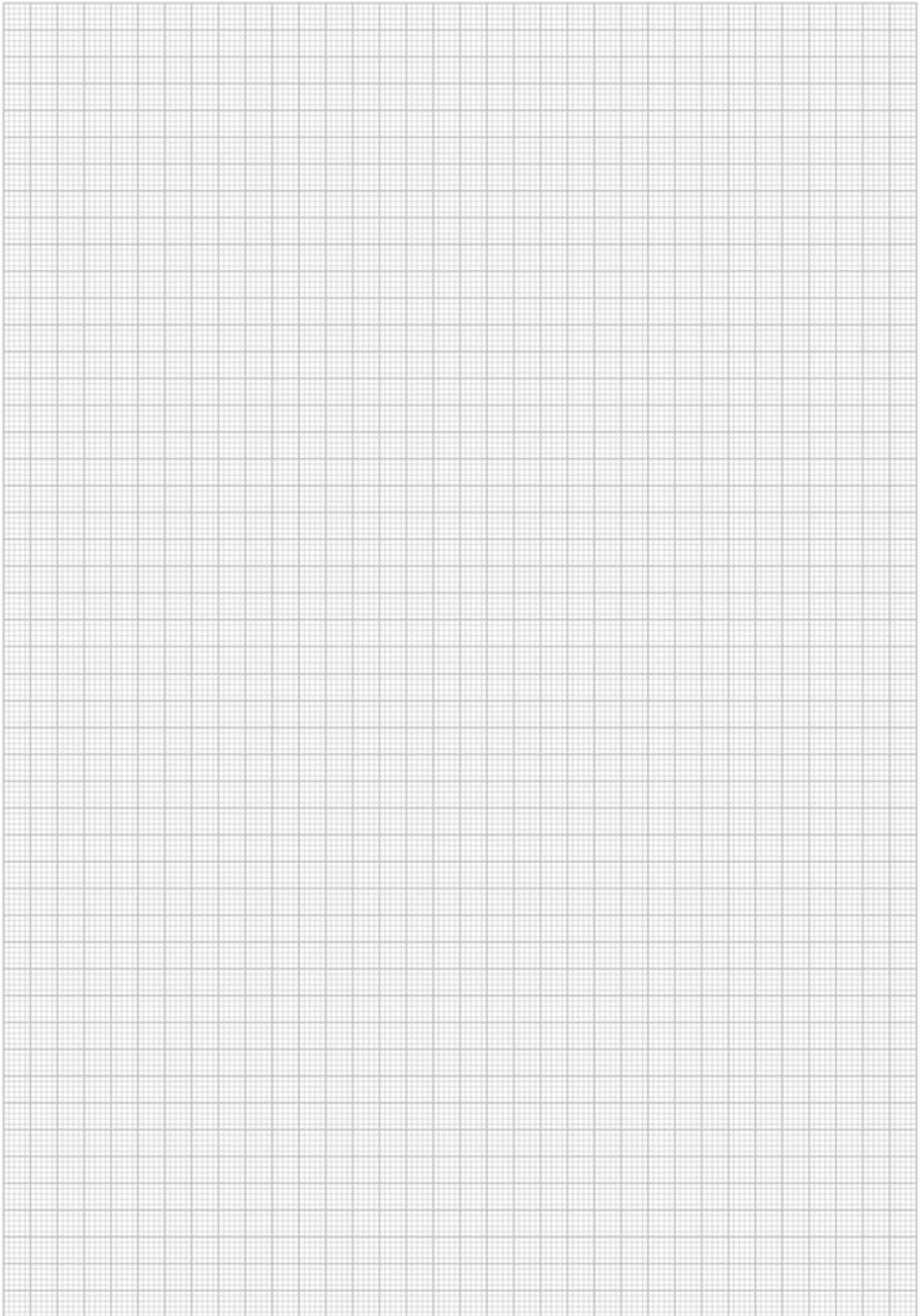

Ureteroskopie
Ureteroscopy
Ureteroscopia
Urétéroscopie
Uretroscopia



Uretero Renoskop halbstarr
Uretero renoscope semiflexible

XP 740/42

komplett mit	XP 740/01 + XP 740/04
complete with	XP 740/01 + XP 740/04
completo con	XP 740/01 + XP 740/04
complet avec	XP 740/01 + XP 740/04
completo con	XP 740/01 + XP 740/04



Adapter für Lithotripsie
Adaptor for lithotripsy

XP 740/01



Spülhahnaufnahme
Stopcock input unit

XP 740/04

Ureteroskopie
 Ureteroscopy
 Ureteroscopia
 Urétéroscopie
 Uretroscopia

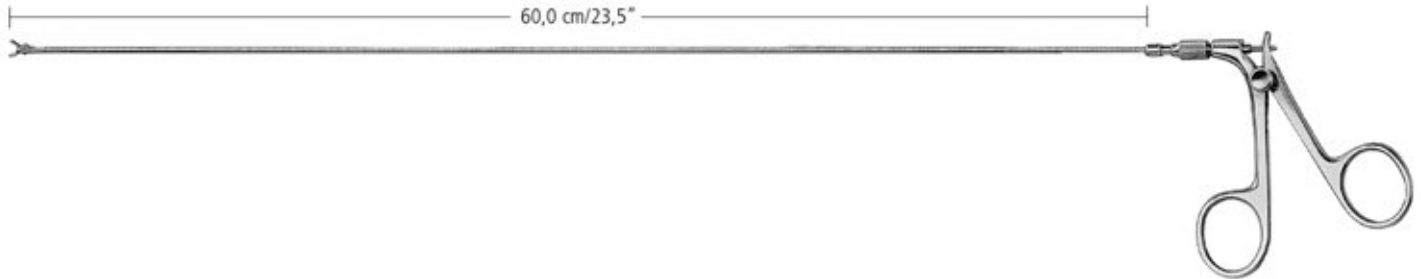

Ø 5 CH XK 935/60



Ø 5 CH XK 936/60



Ø 5 CH XK 937/60

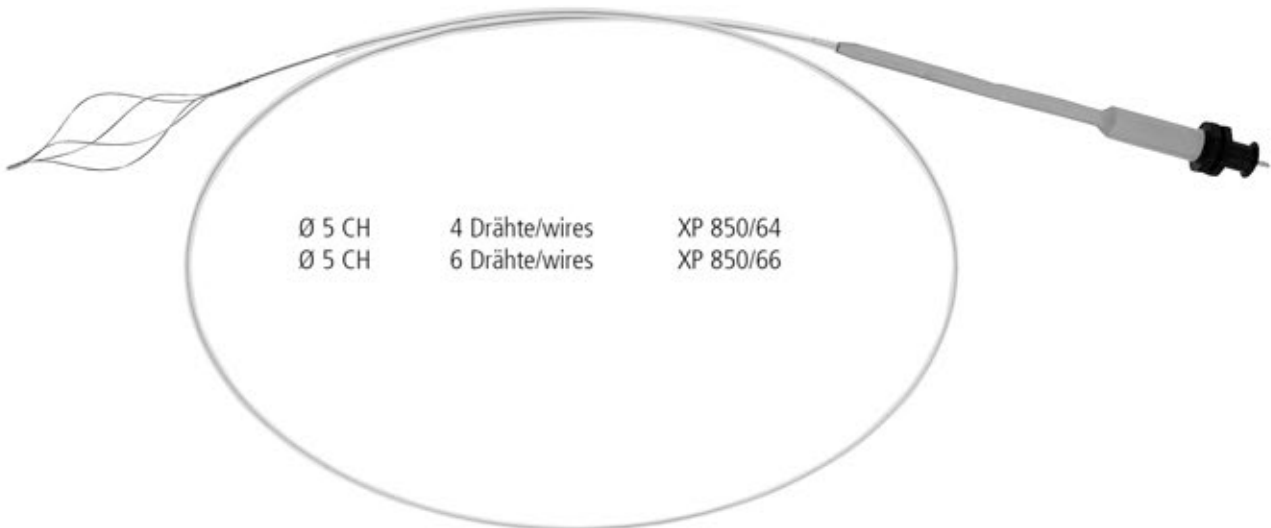

Ø 5 CH 4 Drähte/wires XP 850/64
 Ø 5 CH 6 Drähte/wires XP 850/66



XP 850/80

Nephroskopie
Nephroscopy
Nefroscopia
Néphroscopie
Nefroscopia

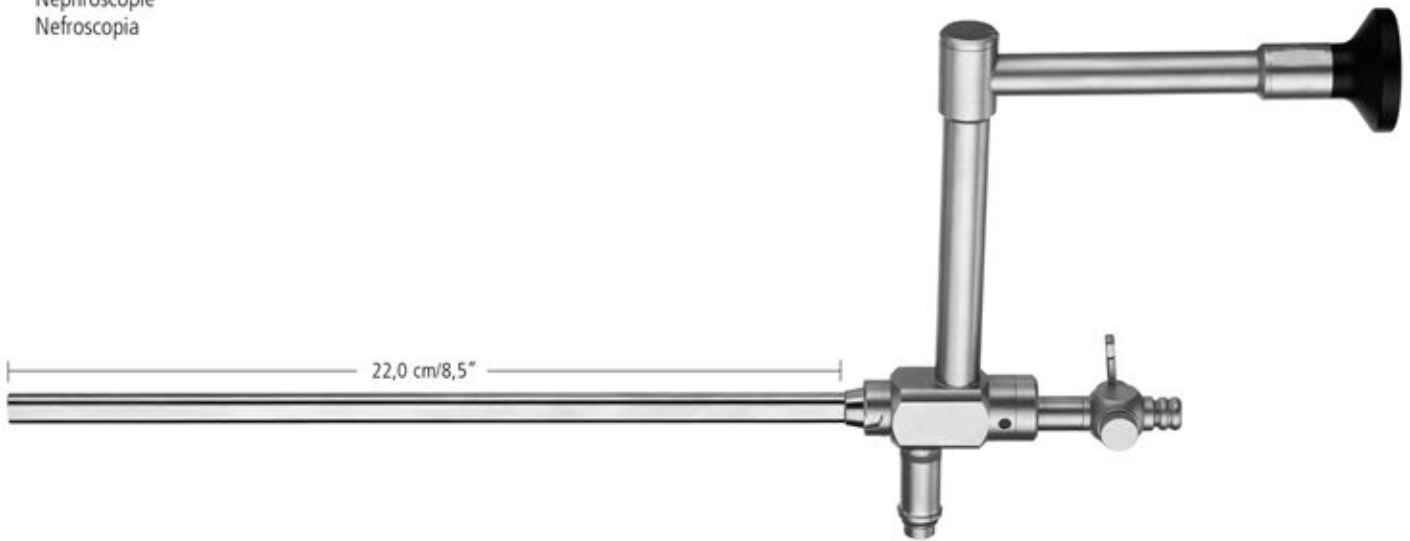

Nephroskop
Nephroscope

XP 745/22



Schaft mit Obturator
Sheath with obturator

Ø 27 CH
Ø 27 CH XP 745/27



Schaft
Sheath

Ø 27 CH
Ø 27 CH XP 745/28





Obturator
Obturator

XP 745/29

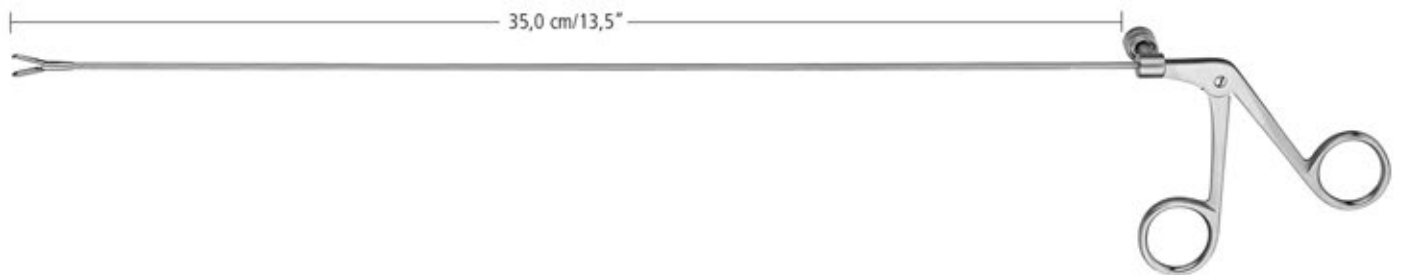
Nephroskopie
Nephroscopy
Nefroscopia
Néphroscopie
Nefroscopia



	Ø 9 CH	XK 936/35
	Ø 9 CH	XK 937/35
	Ø 9 CH	XK 938/35

Urologie Pumpe
Urology Pump
Bomba para Urologia
Pompe d'Urologie
Pompa per Urologia



XU 174/00

urologie pumpe

Beschreibung XU 174/00

Die urologie pumpe wird in der diagnostischen und operativen Urologie eingesetzt.

Durch den applizierten Flüssigkeitsstrom gewährleisten wir klare Sichtverhältnisse während des Eingriffes durch das Ausspülen von gelösten Partikeln.

Die drehzahlgeregelte Rollenpumpe erlaubt eine stufenlose Regelung bis 1000 ml/min.

Technische Daten

Technische Änderungen zur Produktverbesserung vorbehalten.

Höhe:	132 mm
Breite:	300 mm
Tiefe:	335 mm
Gewicht:	ca. 5,8 kg
Netz:	220V/50-60Hz/60VA oder 110V/50-60Hz/60VA

Rollenpumpe

Druckvorwahl:	10-150 mm Hg
Fördermenge:	0-1000 ml/min.

Bestelldaten

XU 174/00	urologie pumpe einschließlich:
XU 174/10	Netzanschlusskabel
XU 174/13	Schlauchset

Bei Bestellung bitte Netzspannung angeben.

urology pump

Description XU 174/00

The urology pump is used in diagnostic and operative Urology.

Because of the administered flow of liquid, we guarantee clear visibility during operations by flushing of loosened particles.

The regulated roller pump allows a continuous regulation up to 1000 ml/min.

Technical data

Specification subject to change without notice.

Height:	132 mm
Length:	300 mm
Depth:	335 mm
Weight:	approx. 5,8 kg
Mains:	220V/50-60Hz/60VA oder 110V/50-60Hz/60VA

Roller pump

Pressure Pre-selection:	10-150 mm Hg
Flow regulation:	0-1000 ml/min.

Reference data

XU 174/00	urology pump including:
XU 174/10	Power cable
XU 174/13	Tubing set

Please indicate the voltage when placing the order.

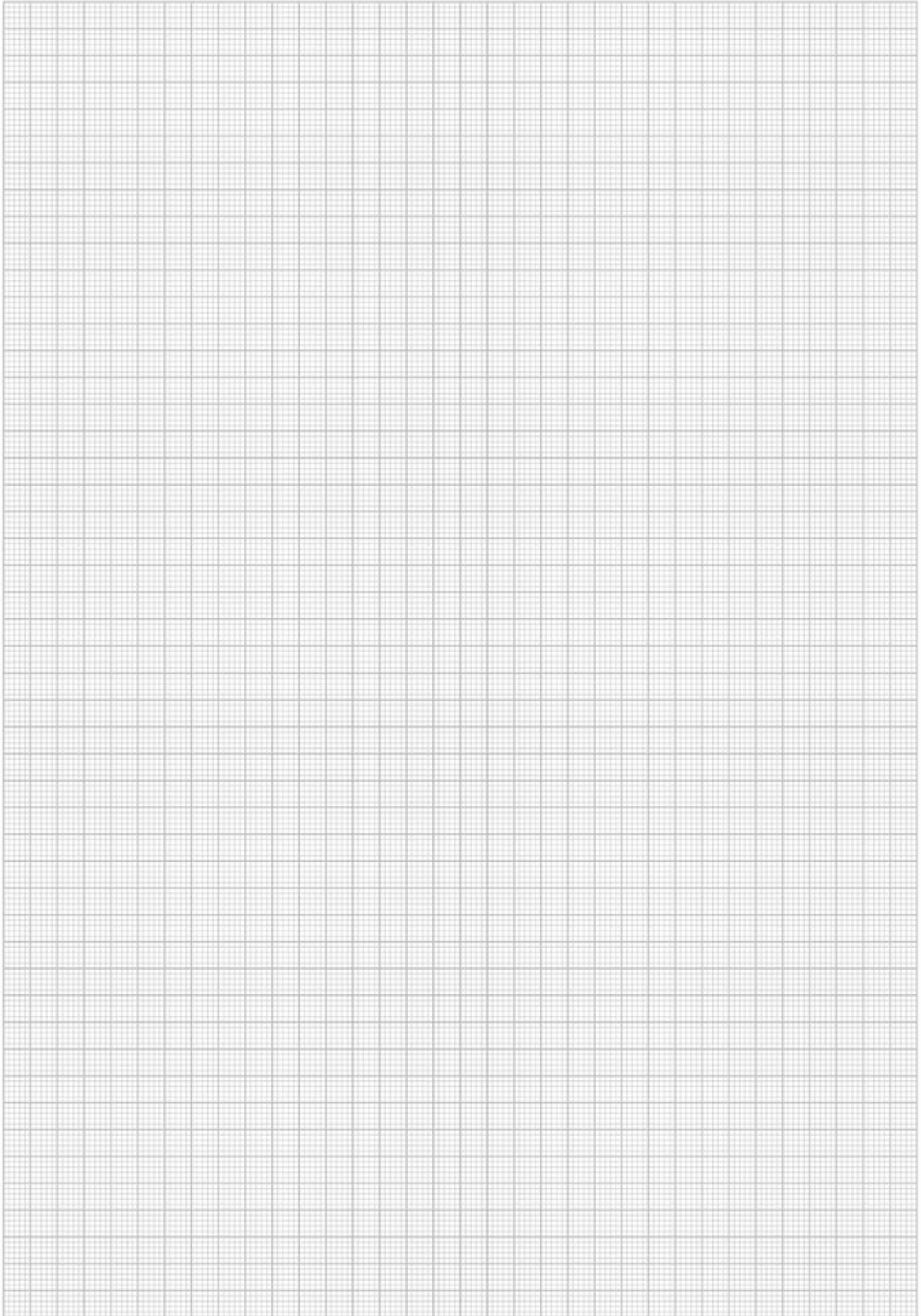

KALTLICHTQUELLEN, KAMERAS
COULD LIGHT SOURCES, CAMERAS
FUENTES DE LUZ FRIA, CAMARAS
SOURCES A LUMIERE FROIDE, CAMERAS
SORGENTE LUCE FREDDA,
MACCHINE FOTOGRAFICHE

18

nopa[®] instruments



Kaltlichtkabel
 Fibre optic cable
 Cable fibra óptica
 Câble fibre optique
 Cavo fibra ottica



XT 035/18	Ø 3,5 mm, 180 cm
XT 035/23	Ø 3,5 mm, 230 cm
XT 035/30	Ø 3,5 mm, 300 cm
XT 045/18	Ø 4,5 mm, 180 cm
XT 045/23	Ø 4,5 mm, 230 cm
XT 045/30	Ø 4,5 mm, 300 cm
XT 060/18	Ø 6,0 mm, 180 cm
XT 060/23	Ø 6,0 mm, 230 cm
XT 060/30	Ø 6,0 mm, 300 cm

Kaltlicht-Grundkabel
Basic fibre optic cable



XT 070/18	Ø 4,5 mm, 180 cm
XT 070/23	Ø 4,5 mm, 230 cm
XT 070/30	Ø 4,5 mm, 300 cm

- >> **Zusätzliche Isolierung**
- >> **Metallspirale**
- >> **Silikonmantel**
- >> **Sterilisierbar**
- >> **48-Stunden Reparatur-Service**

- >> **Additionally insulated**
- >> **Metal spiral**
- >> **Silicon tube**
- >> **Autoclavable**
- >> **48-hour repair-service**

Adapter
Adapter
Adaptador
Adaptateur
Adattatore

Projektor-Seite
Projector side

Endoskop-Seite
Endoscope side

XT 100/01



STORZ



XT 100/11

STORZ/WINTER + IBE
OPLYMPUS/STRYKER

XT 100/02



WOLF/HENKE-SASS



XT 100/12

WOLF/HENKE-SASS

XT 100/03



ACM/HEINE



XT 100/13

ACM/HEINE

XT 100/04



WINTER + IBE

XT 100/05



OPLYMPUS

Bestellinformation / Ordering information

>> Bitte bestellen Sie Kaltlicht-
grundkabel mit 2 Adaptern

>> Please order the basic fibre
optic cable and two adapters

Kaltlichtquellen
Cold light sources
Fuente de luz fria
Source à lumière froide
Sorgente luce fredda

nopa[®] light halogen 150W

XT 140/00 = 230 VAC/50Hz
XT 140/01 = 110 VAC/60Hz

XT 139/00 = Ersatzlampe
Spare bulb
Bombilla de recambio
Lampe de rechange
Lampadina di ricambio



nopalight halogen 150W

Beschreibung XT 140/00 - XT 140/01

Die nopalight halogen 150 W Lichtquelle kann bei allen endoskopischen Einsätzen angewendet werden, bei welchen die Lichtintensität nicht allzu hoch sein muss, beispielsweise in der Arthroskopie, Diagnostik oder der Mikroskopie.

Die nopalight 150 W Lichtquelle bietet eine konstant lichtstarke Ausleuchtung des Untersuchungsfeldes, mittels einer stufenlosen Helligkeitsregelung.

Kompaktes, platzsparendes Design sowie die einfache, benutzerfreundliche Bedienung sind weitere Vorteile.

Technische Daten

XT 140/00 = 230 VAC/50Hz
XT 140/01 = 110 VAC/60Hz

Farbtemperatur:	max. 3600° K
Maße (B x H x T)	190 x 115 x 180 mm
Gewicht:	ca. 3,3 kg
Lampe XT 139/00:	150 Watt Halogen

nopalight halogen 150W

Description XT 140/00 - XT 140/01

The nopalight halogen 150 W lightsource, can be utilized in all endoscopic procedures, where extreme light-intensity is not required, i.e. arthroscopy, diagnostics and microscopy.

The nopalight 150 W lightsource offers a constant light-intensity for the illumination of the operating field by means of continuous brightness control.

The compact, efficient design, as well as the easy handling are further advantages.

Technical data

XT 140/00 = 230 VAC/50Hz
XT 140/01 = 110 VAC/60Hz

Color temperature:	max. 3600° K
Measurements (W x H x D):	190 x 115 x 180 mm
Weight:	approx. 3,3 kg
Bulb XT 139/00:	150 Watt Halogen

Kaltlichtquellen
Cold light sources
Fuente de luz fría
Source à lumière froide
Sorgente luce fredda

nopa® light halogen 2 x 250W future 100



XT 170/00 = 110 - 230 VAC

XT 169/00 = Ersatzlampe
Spare bulb
Bombilla de recambio
Lampe de rechange
Lampadina di ricambio

nopalight halogen 2 x 250W

Beschreibung XT 170/00

Die nopalight halogen 2 x 250 W Lichtquelle kann bei allen Einsätzen angewendet werden, besonders dann, wenn eine starke Ausleuchtung oder eine Videoaufzeichnung notwendig ist.

Alle modernen Autoshutter-Videokameras werden mit ausreichender Lichtzufuhr versorgt. Die zweite Lampe wird als Reserve bei Lampen-defekten oder Lampenausfall durch sofortiges Umschalten während den Einsätzen aktiviert.

Spezielle Wärmeschutzfilter sorgen für eine Schonung der Lichtleiter und eine optimale Lichtfiltrierung. Das Gerät ist MedGV-geprüft.

Technische Daten

Elektr. Versorgung: 100-240 VAC/50-60Hz
Weltnetzteil

Farbtemperatur: über 3500° K

Lichtregelung: automatisch, stufenlos

Maße
(B x H x T): 355 x 110 x 320 mm

Gewicht: ca. 8,5 kg

Zubehör

Lampe XT 169/00: 250 Watt Halogen

nopalight halogen 2 x 250W

Description XT 170/00

The nopalight halogen 2 x 250 W lightsource can be utilized in all procedures, especially if a strong illumination or video-monitoring is required.

All modern autoshutter-videocameras will be supplied with sufficient light-intensity, the second lamp serves as stand-by. Simply switch-over.

Special temperature-filters guarantee long life of light cables and optimal light output. The nopalight halogen 2 x 250 W lightsource is approved by MedGV.

Technical data

Power supply: 100-240 VAC/50-60Hz
world power supply

Color temperature: more than 3500° K

Light control: automatic

Measurements
(W x H x D): 355 x 110 x 320 mm

Weight: approx. 8,5 kg

Accessories

Bulb XT 169/00: 250 Watt Halogen

Kaltlichtquellen
Cold light sources
Fuente de luz fria
Source à lumière froide
Sorgente luce fredda

nopa[®] light xenon future 200 180W

XT 205/00 = 110-230 VAC/50/60 Hz

XT 204/00 = Ersatzlampe
Spare bulb
Bombilla de recambio
Lampe de rechange
Lampadina di ricambio



nopalight xenon 180W

Beschreibung XT 205/00

Die nopalight xenon 180 Watt Lichtquelle kann bei allen Einsätzen angewendet werden, besonders dann, wenn eine starke Ausleuchtung oder eine Videoaufzeichnung notwendig ist.

Alle modernen Autoshutter-Videokameras werden mit ausreichender Lichtzufuhr versorgt. Die hohe Lichtausgangsleistung sorgt für absolut weißes Licht >5600°K und somit für detailgetreue Farbwiedergabe.

Unsere spezielle Lampenkonstruktion mit geringster Wärmeentwicklung führt zu absolut kaltem Licht und verhindert eine thermische Beschädigung der Lichtleiter.

Weitere Vorteile: Geringe Luftverwirbelungen, geringe Geräuschentwicklung, umweltfreundliche Lampe, einfachster Lampenwechsel.

Technische Daten

Elektr. Versorgung:	110-230 VAC/50-60Hz Weltnetzteil
Farbtemperatur:	> 5600° K
Maße (B x H x T):	355 x 110 x 320 mm
Gewicht:	ca. 9,5 kg

Zubehör

Lampe XT 204/00: 180 Watt Xenon

nopalight xenon 180W

Description XT 205/00

The nopalight xenon 180 watt light source can be used for all occasions particularly where strong illumination or a video recording is necessary.

All modern autoshutter videocameras are supplied with sufficient light. The high light output ensures absolute white light >5600° K and thus detail fidelity in colour reproduction.

Our special lamp construction which has the lowest of heat generation leads to absolute cold light and prevents thermal damage to the light conductor.

Further advantages are low air turbulence, low noise level, environmentally friendly lamp and very easy bulb replacement.

Technical data

Power supply:	110-230 VAC/50-60Hz world power supply
Colour temperature:	> 5600° K
Measurements (W x H x D):	355 x 110 x 320 mm
Weight:	approx. 9,5 kg

Accessories

Bulb XT 204/00: 180 Watt Xenon

nopa[®] cam digital camera system

immersible soakable



PAL/SECAM		
XT 301/00	=	XT 310/00 XT 320/01
		Netzkabel/mains cord
		Kamerakopf inkl. Kabel 3,8 m, einlegbar camera head incl. cable 3,8 m, immersible
		XT 320/02 Kameraprozessor / camera control unit
		XT 344/02 Kabel/cable S-VHS
		XT 346/00 Kabel/cable BNC
NTSC		
XT 301/01	=	XT 310/00 XT 320/03
		Netzkabel/mains cord
		Kamerakopf inkl. Kabel 3,8 m, einlegbar camera head incl. cable 3,8 m, immersible
		XT 320/04 Kameraprozessor/camera control unit
		XT 344/00 Kabel/cable S-VHS
		XT 346/00 Kabel/cable BNC

Beschreibung XT 301/00 / XT 301/01

nopa cam m ist die konsequente Weiterentwicklung unseres Kamerasystems. Neben allen früheren Funktionen wurden weitere Spezialfunktionen realisiert. Eine integrierte Steuerung externer Geräte (Videorecorder, Drucker) sowie die Lichtverstärkung können mittels zwei Funktionstasten direkt am Kamerakopf aktiviert werden.

Die Kamera ist mit digitaler Kontrast- und Farbsteuerung ausgestattet. Ebenfalls verfügt sie über einen digitalen anti-moiré Filter für den Gebrauch mit flexiblen Endoskopen.

Die Kamera arbeitet optimal mit starren wie auch flexiblen Endoskopen. Selbstverständlich ist der Kamerakopf einlegbar.

Technische Daten

XT 301/00 PAL - XT 301/01 NTSC

CCD Sensor:	1/3" Chip
Video-Auflösung:	750 horizontale Bildlinien
Minimale Beleuchtung:	0,9 Lux
Video-Ausgang:	FBAS oder Y/C (S-VHS)
Elektr. Versorgung:	100/115VAC und 230/240VAC
Gewicht:	2 kg

Weiteres Zubehör

XT 301/02 Kamera mit C-Mount Gewinde PAL
 XT 301/03 Kamera mit C-Mount Gewinde NTSC
 XT 306/00 Bildteiler

XT 361/40 Zoom Adapter 15 - 25 mm
 XT 361/50 Zoom Adapter 25 - 40 mm
 verwendbar mit XT 301/02 und XT 301/03

Description XT 301/00 / XT 301/01

nopa cam m is the consequent improvement of our camera system. Besides all the previous functions further special functions have been realized. An integrated control of peripheral devices (VCR, printer), as well as the Gain Control can be operated with the help of two buttons directly from the camera head.

Our camera is equipped with digital contrast and colour control and a digital anti-moiré filter for use with flexible endoscopes.

The camera serves both rigid and flexible endoscopes optimally. Of course the camera head is fully immersible.

Technical data

XT 301/00 PAL - XT 301/01 NTSC

CCD sensor:	1/3" Chip
Video resolution:	750 horizontal lines
Minimal illumination:	0,9 Lux
Video output:	FBAS or Y/C (S-VHS)
Power supply:	100/115VAC and 230/240VAC
Weight:	2kg

Optional accessories

XT 301/02 camera with C-mount adapter PAL
 XT 301/03 camera with C-mount adapter NTSC
 XT 306/00 beam splitter

XT 361/40 Zoom adapter 15 - 25 mm
 XT 361/50 Zoom adapter 25 - 40 mm
 to use with XT 301/02 and XT 301/03

nopa[®] cam digital camera system

immersible soakable

PAL/SECAM XT 302/00	=	XT 310/00	Netzkabel/mains cord
		XT 302/10	Kamerakopf inkl. Kabel 3,8 m, einlegbar/ camera head incl. cable 3,8 m, immersible
		XT 302/12	Kameraprozessor/camera control unit
		XT 344/02	Kabel/cable S-VHS
NTSC XT 302/01	=	XT 310/00	Netzkabel/mains cord
		XT 302/11	Kamerakopf inkl. Kabel 3,8 m, einlegbar/ camera head incl. cable 3,8 m, immersible
		XT 302/13	Kameraprozessor/camera control unit
		XT 344/02	Kabel/cable S-VHS



Beschreibung XT 302/00 / XT 302/01

Das nopa cam S camera system ist eine wirtschaftliche Office-Kamera mit ausgezeichneten Eigenschaften. Beste Bildqualität, scharfe Bildzeichnung und Klarheit werden durch den 1/4" CCD-Chip gewährleistet.

Die optimale Bilddarstellung aufgrund eines hochempfindlichen Mikro-Linsen-Chip sowie einer äußerst schnellen Blende wird auch unter schwierigen Beleuchtungsbedingungen sichergestellt. Der Kamerakopf ist leicht, ergonomisch und einlegbar. Der automatische Weißabgleich wird durch Schalterdruck aktiviert und ist im Memory gespeichert.

Aufgrund des hohen Automatisierungsstandards der nopa cam S ist das Kamerasystem sehr bedienerfreundlich.

Technische Daten

XT 302/00 PAL - XT 302/01 NTSC

CCD Sensor:	1/4" Chip
Video-Auflösung:	über 500 Linien
Minimale Beleuchtung:	0,9 Lux
Video Ausgang:	FBAS oder Y/C (S-VHS)
Elektr. Versorgung:	110/115 VAC - und 230/240 VAC
Gewicht:	1 kg

Weiteres Zubehör

XT 302/02 Kamera mit C-Mount Gewinde PAL
XT 302/03 Kamera mit C-Mount Gewinde NTSC
XT 306/00 Bildteiler

XT 361/40 Zoom Adapter 15 - 25 mm
XT 361/50 Zoom Adapter 25 - 40 mm
verwendbar mit XT 302/02 und XT 302/03

Description XT 302/00 / XT 302/01

The nopa cam S camera system is an economic office camera with excellent characteristics. The best possible picture quality, picture delineation and clarity are ensured by the 1/4" CCD chip.

Optimal picture presentation is ensured by a highly sensitive micro-lens chip with an extremely rapid diaphragm even under difficult lighting conditions. The camera head is light, ergonomic and immersible. The automatic white compensation is activated by press button and is stored in the memory.

The nopa cam S high level of automatic operation makes this camera system extremely easy to operate.

Technical data

XT 302/00 PAL - XT 302/01 NTSC

CCD sensor:	1/4" chip
Video resolution:	more than 500 lines
Minimal illumination:	0,9 Lux
Video output:	FBAS or Y/C (S-VHS)
Power Supply:	110/115 VAC - and 230/240 VAC
Weight:	1 kg

Optional accessories

XT 302/02 camera with C-mount adapter PAL
XT 302/03 camera with C-mount adapter NTSC
XT 306/00 beam splitter

XT 361/40 Zoom adapter 15 - 25 mm
XT 361/50 Zoom adapter 25 - 40 mm
to use with XT 302/02 and XT 302/03

Zoom - Adapter
 Zoom - Adapter
 Zoom - Adaptador
 Zoom - Connexion
 Zoom - Adattatore



XT 361/40

Zoom - Objektiv	15 mm - 25 mm
zoom - objective	15 mm - 25 mm



XT 361/50

Zoom - Objektiv	25 mm - 40 mm
Zoom - objective	25 mm - 40 mm

Zoom Adapter mit C-Mount Anschluss für nopa Kameras
 XT 301/02, XT 301/03, XT 302/02, XT 302/03 und XT 305/00, XT 305/01.
 Zoom adapter with C-mount connection for nopa camera systems
 XT 301/02, XT 301/03, XT 302/02, XT 302/03 and XT 305/00, XT 305/01.

Flachbildschirm mit Standfuß
 Flatscreen with base
 Pantalla plana con pie
 Ecran plat de visualisation avec base de support
 Schermo piatto con supporto



XT 404/19

monitor

Beschreibung XT 404/19

Der nopa Flachbildschirm in 19" wurde entwickelt für den Einsatz im Bereich der minimalinvasiven Chirurgie. Aufgrund der Aluminium Leichtbauweise können die Monitore an alle OP Arme, Trolleys und OP Lampen montiert werden.

Ein dichtes Gehäuse und eine Folientastatur bilden die Voraussetzungen, dass die Monitore feucht gereinigt werden können.

Die hohe Auflösung von 1280 x 1024 Pixel gewährleistet optimale Bildqualität mit maximaler Detailtreue in Kombination mit den nopa-Kamerasystemen.

Der Standfuß ist höhenverstellbar und hat ein Kugelgelenk wodurch der optimale Blickwinkel erreicht werden kann.

Technische Daten

XT 404/19	Medizinischer LCD Monitor 19" 100-240VAC, 50-60 Hz
Farbsystem:	PAL, SECAM, NTSC automatische Einstellung
Blickwinkel:	170° / 170°
Auflösung:	1280 x 1024 Pixel
Video-/Audio- Eingang:	DVI-I, VGA (über DVI), FBAS, S-VHS
Maße:	19"
Höhe:	386 mm
Breite:	442 mm
Tiefe:	67 mm
Gewicht:	6,9 kg

Optional

XT 404/01	Standfuß allein
XT 404/02	Haltearm für nopa mobil

monitor

Description XT 404/19

The nopa 19" flat screen was developed for use in the area of minimal invasive surgery. Due to the aluminium lightweight construction, the monitors can be mounted to all OP arms, trolleys and OP lamps.

A leak-tight housing and foil keyboard are required for wet-cleaning the monitors.

The resolution of 1280 x 1024 pixels guarantees optimum image quality with maximum detail precision in combination with the nopa camera systems.

The monitor stand can be adjusted (height) and has a ball joint, which allows the viewing angle to be optimally reached.

Technical data

XT 404/19	Medical LCD monitor 19" 100-240VAC, 50-60 Hz
Colour system:	PAL, SECAM, NTSC automatic selection
Field of view:	170° / 170°
Resolution:	1280 x 1024 pixels
Video-/Audio- input:	DVI-I, VGA (across DVI), FBAS, S-VHS
Measurements:	19"
Height:	386 mm
Width:	442 mm
Depth:	67 mm
Weight:	6,9 kg

Optional

XT 404/01	Base only
XT 404/02	Swinging arm for nopa mobil

Flachbildschirm mit Armsystem
 Flatscreen with swinging arm system
 Pantalla plana consistema de brazo giratorio
 Ecran plat de visualisation avec système de bras
 Schermo piatto con braccio mobile

XT 405/19



12

18

20

22

monitor

Beschreibung XT 405/19

Der nopa Flachbildschirm in 19" wurde entwickelt für den Einsatz im Bereich der minimalinvasiven Chirurgie. Aufgrund der Aluminium Leichtbauweise können die Monitore an alle OP Arme, Trolleys und OP Lampen montiert werden.

Ein dichtes Gehäuse und eine Folientastatur bilden die Voraussetzungen, dass die Monitore feucht gereinigt werden können.

Die hohe Auflösung von 1280 x 1024 Pixel gewährleistet optimale Bildqualität mit maximaler Detailtreue in Kombination mit den nopa-Kamerasystemen.

Das Armsystem kann in beliebiger Höhe am nopa mobil montiert werden und bietet somit die bestmögliche Einstellung des Blickwinkels.

Technische Daten

XT 405/19	Medizinischer LCD Monitor 19" 100-240VAC, 50-60Hz
Farbsystem:	PAL, SECAM, NTSC automatische Einstellung
Blickwinkel:	170° / 170°
Auflösung:	1280 x 1024 Pixel
Video-/Audio-Eingang:	DVI-I, VGA (über DVI), FBAS, S-VHS
Maße:	19"
Höhe:	386 mm
Breite:	442 mm
Tiefe:	67 mm
Gewicht:	6,9 kg

monitor

Description XT 405/19

The nopa 19" flat screen was developed for use in the area of minimal invasive surgery. Due to the aluminium lightweight construction, the monitors can be mounted to all OP arms, trolleys and OP lamps.

A leak-tight housing and foil keyboard are required for wet-cleaning the monitors.

The resolution of 1280 x 1024 pixels guarantees optimum image quality with maximum detail precision in combination with the nopa camera systems.

The arm system can be mounted at any height on the nopa mobil, and allows the best possible viewing angle to be set.

Technical data

XT 405/19	Medical LCD monitor 19" 100-240VAC, 50-60Hz
Colour system:	PAL, SECAM, NTSC automatic selection
Field of view:	170° / 170°
Resolution:	1280 x 1024 pixels
Video-/Audio-Input:	DVI-I, VGA (across DVI), FBAS, S-VHS
Measurements:	19"
Height:	386 mm
Width:	442 mm
Depth:	67 mm
Weight:	6,9 kg

USB Aufzeichnungsgerät für Video Einzelbilder
 USB documentation system to capture video images
 Sistema de documentación USB para grabar imágenes de video
 Enregistreur USB pour clichés vidéo
 Registratore USB per singole immagini video



XT 448/00



MEDICAPTURE

Beschreibung XT 448/00

MEDICapture ist ein neuer Weg um Videobilder auf einem USB - Datenträger zu speichern. Verschiedene Videosysteme und Eingänge machen das MEDICapture zu einem sehr flexiblen Instrument für die Inspektion und Dokumentation. MEDICapture kann an jeder Kamera, jedem Videoendoskop und Mikroskop mit analogem Ausgang betrieben werden. Bilder werden in Standardformaten (JPEG/BMP) mit automatisch generierten Dateinamen abgespeichert. Das MEDICapture generiert ebenfalls eine Vorschauansicht zur Überprüfung oder Löschen der Dateien auf dem Monitor. Die Dateien können sehr einfach auf jeden Computer mit USB Anschluss übertragen werden.

Technische Daten:

XT 448/00	MEDICapture 100 - 240VAC, 50 - 60 Hz
Farbsystem:	PAL, NTSC einstellbar
Videoeingang:	1 Composite Videoeingang 1 S-VHS / Y/C-Eingang
Videoausgang:	1 Composite Videoausgang 1 S-VHS / Y/C-Ausgang
Medium:	USB - Speichermedium
Dateiformat:	DICOM, DICOM Hochauflösend JPEG, BMP
Bildgröße: Standard:	800 x 600 Bildpunkte FCC, UL
Höhe:	63 mm
Breite:	240 mm
Tiefe:	200 mm
Gewicht:	680 g

Weiteres Zubehör:

XT 448/10	Fußschalter
-----------	-------------

MEDICAPTURE

Description XT 448/00

MEDICapture is the new simple way to capture video images on a USB - Memory-Stick. Different video systems and different input standards make the MEDICapture a very flexible instrument for inspection and documentation. MEDICapture can be connected to any camera, videoscope and microscope with analog outputs. Images are compressed and stored with auto generated filenames and information in standard file formats (JPEG/BMP). MEDICapture generates a preview on the display to verify, erase or show the images. The files can be uploaded very simple to every computer with USB connection.

Technical Data:

XT 448/00	MEDICapture 100 - 240VAC, 50 - 60 Hz
Colour system:	PAL, NTSC switchable
Video input:	1 Composite Video input 1 S-VHS / Y/C-Input
Video output:	1 Composite Video output 1 S-VHS / Y/C-output
Media:	USB - Stick
File Format:	DICOM, DICOM True color JPEG, BMP
Image size: Approvals:	800 x 600 Pixel FCC, UL
Height:	63 mm
Width:	240 mm
Depth:	200 mm
Weight:	680 g

Optional Accessories:

XT 448/10	Foot-Switch
-----------	-------------

INSUFFLATOREN / SAUG- UND SPÜLGERÄTE
INSUFLATORS / SUCTION AND IRRIGATION
UNITS

INSUFLADORES / UNIDAD DE SUCCION Y
IRRIGACION

INSUFFLATEURS / USTENSILES D'ASPIRATION /
IRRIGATION

INSUFFLATORE / UNITA DE ASPIRAZIONE ED
IRRIGAZIONE

20

nopa[®] instruments



Insufflator
Insufflator
Insufladores
Insufflateurs
Insufflator

nopa[®] flow 16 l future 200

Gasfluss: 16 l/min.
Gasflow: 16 l/min.

XU 140/00 - 140/03



Beschreibung XU 140/00 - XU 140/03

Der nopaflow 16 l future 200 ermöglicht eine sichere Anlage des Pneumoperitoneums während der diagnostischen und operativen Laparoskopie.

Durch moderne prozessorgesteuerte Druck- und Flowregelung ergibt sich eine hohe Regelgenauigkeit, sowohl bei herkömmlichen als auch bei strömungstechnisch weiterentwickelten Instrumenten. Die Regelschnelligkeit ist optimiert durch den Insufflationsmodus (LPS/RGLC).

Eine hohe Applikationssicherheit ist garantiert durch die extrem schnelle Nachregelung des Druckes bei Druckverlust sowie die konsequente Ausregelung von Leckagen ohne störende Druckschwankungen. Bei Drucküberschreitungen oder Zuleitungsschluss erfolgt ein Warnsignal sowie ein Flowstop. Automatische Anzeige bei Gasmangel.

Neben der automatischen Selbsttest-Routine nach jedem Einschalten verfügt der nopaflow 16 l future 200 über eine automatische Fehlercode-Anzeige.

Technische Daten

Technische Änderungen zur Produktverbesserung vorbehalten.

Netz: umschaltbar auf 100-110/220-240VAC, 50/60Hz
Druckvorwahl: 4-25 mm Hg.
Gasfluss: 16 l/min
Gewicht: ca. 4,5 kg
Höhe: 145 mm
Breite: 300 mm
Tiefe: 320 mm

Bestelldaten

XU 140/00 nopaflow 16 l future 200
mit deutschem Anschluss für CO₂
XU 140/01 nopaflow 16 l future 200
mit amerikanischem Anschluss für CO₂
XU 140/02 nopaflow 16 l future 200
mit PIN-Index Anschluss für CO₂
XU 140/03 nopaflow 16 l future 200
mit italienischem Anschluss für CO₂

Jeweils einschließlich

XU 140/10 Schlüssel für CO₂ Flasche
XU 140/11 Netzanschlusskabel
XU 140/12 Insufflationsschlauch mit Anschlussstück
XU 140/13 High-Flow-Verres-Kanüle (LL)

Zubehör

XU 140/60 CO₂ Flasche deutsch
XU 140/70 CO₂ Flasche PIN-Index
XU 140/75 CO₂ Flasche ISO (auf Anfrage)
XU 140/90 Flaschenhalterung
XU 140/91 Flexibler Hochdruckschlauch 1m US-DT
XU 140/92 Flexibler Hochdruckschlauch 1m US-PIN-Index
XU 140/93 Flexibler Hochdruckschlauch 1m US-Italien

Weitere Versionen bis 40 l/min erhältlich

Description XU 140/00 - XU 140/03

The nopaflow 16 l future 200 ensures a safe introduction of the pneumoperitoneum during diagnostic and operative laparoscopy.

A high-tech processing unit for the pressure and flowcontrol guarantees a high accuracy for all instruments. The regulating speed is optimized by means of the safety technology mode (LPS/RGLC).

High application security is guaranteed by the extremely fast readjustment of pressure after pressure loss and consequent deviation control of pressure leakages without any pressure fluctuation. In case of exceeding pressure of supply clogging a warning signal and a flow-stop will be activated. Automatic display during loss of gas.

Besides automatic self-testing routine after every start, the nopaflow 16 l future 200 is equipped with an automatic error-code display. Maintenance of the system is easy, by means of operational instructions of the program.

Technical data

Technical specifications subject to change without notice.

Mains-supply: switchable 100-110/220-240VAC, 50/60Hz
Pressure pre-selection: 4-25 mm Hg
Gasflow: 16 l/min
Weight: approx. 4,5 kg
Height: 145 mm
Width: 300 mm
Depth: 320 mm

Reference data

XU 140/00 nopaflow 16 l future 200
with German connection for CO₂
XU 140/01 nopaflow 16 l future 200
with American connection for CO₂
XU 140/02 nopaflow 16 l future 200
with PIN-Index connection for CO₂
XU 140/03 nopaflow 16 l future 200
with Italian connection for CO₂

Including

XU 140/10 Wrench for CO₂ cylinder
XU 140/11 Mains supply connection cable
XU 140/12 Insufflating tube with connecting piece
XU 140/13 high-flow-verres cannula (LL)

Accessories

XU 140/60 CO₂ cylinder German
XU 140/70 CO₂ cylinder PIN-Index
XU 140/75 CO₂ cylinder ISO (on request)
XU 140/90 Cylinder holder
XU 140/91 flexible high pressure tubing 1m US-German
XU 140/92 flexible high pressure tubing 1m US-PIN-Index
XU 140/93 flexible high pressure tubing 1m US-Italian

more models up to 40 l/min available

Insufflator
Insufflator
Insufladores
Insufflateurs
Insufflator

nopa[®] flow 20 I future 200



Gasfluss: 20 L/min.
Gasflow: 20 L/min.

XU 141/00 - 141/03

Beschreibung XU 141/00 - XU 141/03

Der nopaflow 20 I future 200 ermöglicht eine sichere Anlage des Pneumoperitoneums während der diagnostischen und operativen Laparoskopie.

Durch moderne prozessorgesteuerte Druck- und Flowregelung ergibt sich eine hohe Regelgenauigkeit, sowohl bei herkömmlichen als auch bei strömungstechnisch weiterentwickelten Instrumenten. Die Regelschnelligkeit ist optimiert durch den Insufflationsmodus (LPS/RGLC).

Eine hohe Applikationssicherheit ist garantiert durch die extrem schnelle Nachregelung des Druckes bei Druckverlust sowie die konsequente Ausregelung von Leckagen ohne störende Druckschwankungen. Bei Drucküberschreitungen oder Zuleitungsschluss erfolgt ein Warnsignal sowie ein Flowstop. Automatische Anzeige bei Gasmangel.

Neben der automatischen Selbsttest-Routine nach jedem Einschalten verfügt der nopaflow 20 I future 200 über eine automatische Fehlercode-Anzeige.

Technische Daten

Technische Änderungen zur Produktverbesserung vorbehalten.

Netz: umschaltbar auf 100-110/220-240VAC, 50/60Hz
Druckvorwahl: 4-25 mm Hg.
Gasfluss: 20 l/min
Gewicht: ca. 4,5 kg
Höhe: 145 mm
Breite: 300 mm
Tiefe: 320 mm

Bestelldaten

XU 141/00 nopaflow 20 I future 200
mit deutschem Anschluss für CO₂
XU 141/01 nopaflow 20 I future 200
mit amerikanischem Anschluss für CO₂
XU 141/02 nopaflow 20 I future 200
mit PIN-Index Anschluss für CO₂
XU 141/03 nopaflow 20 I future 200
mit italienischem Anschluss für CO₂

Jeweils einschließl.

XU 140/10 Schlüssel für CO₂ Flasche
XU 140/11 Netzanschlusskabel
XU 140/12 Insufflationsschlauch mit Anschlussstück
XU 140/13 High-Flow-Verres-Kanüle (LL)

Zubehör

XU 140/60 CO₂ Flasche deutsch
XU 140/70 CO₂ Flasche PIN-Index
XU 140/75 CO₂ Flasche ISO (auf Anfrage)
XU 140/90 Flaschenhalterung
XU 140/91 Flexibler Hochdruckschlauch 1m US-DT
XU 140/92 Flexibler Hochdruckschlauch 1m US-PIN-Index
XU 140/93 Flexibler Hochdruckschlauch 1m US-Italien
XU 141/10 Hygienefilter 5 Stück
XU 141/11 Schlauchadapter für Hygienefilter

Optional

V = Videoboard
T = CO₂ Vorwärmung

Description XU 141/00 - XU 141/03

The nopaflow 20 I future 200 ensures a safe introduction of the pneumoperitoneum during diagnostic and operative laparoscopy.

A high-tech processing unit for the pressure and flowcontrol guarantees a high accuracy for all instruments. The regulating speed is optimized by means of the safety technology mode (LPS/RGLC).

High application security is guaranteed by the extremely fast readjustment of pressure after pressure loss and consequent deviation control of pressure leakages without any pressure fluctuation. In case of exceeding pressure of supply clogging a warning signal and a flow-stop will be activated. Automatic display during loss of gas.

Besides automatic self-testing routine after every start, the nopaflow 20 I future 200 is equipped with an automatic error-code display. Maintenance of the system is easy, by means of operational instructions of the program.

Technical data

Technical specifications subject to change without notice.

Mains-supply: switchable 100-110/220-240VAC, 50/60Hz
Pressure pre-selection: 4-25 mm Hg
Gasflow: 20 l/min
Weight: approx. 4,5 kg
Height: 145 mm
Width: 300 mm
Depth: 320 mm

Reference data

XU 141/00 nopaflow 20 I future 200
with German connection for CO₂
XU 141/01 nopaflow 20 I future 200
with American connection for CO₂
XU 141/02 nopaflow 20 I future 200
with PIN-Index connection for CO₂
XU 141/03 nopaflow 20 I future 200
with Italian connection for CO₂

Including

XU 140/10 Wrench for CO₂ cylinder
XU 140/11 Mains supply connection cable
XU 140/12 Insufflating tube with connecting piece
XU 140/13 high-flow-verres cannula (LL)

Accessories

XU 140/60 CO₂ cylinder German
XU 140/70 CO₂ cylinder PIN-Index
XU 140/75 CO₂ cylinder ISO (on request)
XU 140/90 Cylinder holder
XU 140/91 flexible high pressure tubing 1m US-German
XU 140/92 flexible high pressure tubing 1m US-PIN-Index
XU 140/93 flexible high pressure tubing 1m US-Italian
XU 141/10 hygiene filter 5 pieces
XU 141/11 tube adapter for hygiene filter

Optional

V = Videoboard
T = CO₂ Therme

Insufflator
Insufflator
Insufladores
Insufflateurs
Insufflator

nopa[®] flow 30 I future 200

Gasfluss: 30 L/min.
Gasflow: 30 L/min.

XU 142/00 - 142/03



Beschreibung XU 142/00 - XU 142/03

Der nopaflow 30 I future 200 ermöglicht eine sichere Anlage des Pneumoperitoneums während der diagnostischen und operativen Laparoskopie.

Durch moderne prozessorgesteuerte Druck- und Flowregelung ergibt sich eine hohe Regelgenauigkeit, sowohl bei herkömmlichen als auch bei strömungstechnisch weiterentwickelten Instrumenten. Die Regelschnelligkeit ist optimiert durch den Insufflationsmodus (LPS/RGLC).

Eine hohe Applikationssicherheit ist garantiert durch die extrem schnelle Nachregelung des Druckes bei Druckverlust sowie die konsequente Ausregelung von Leckagen ohne störende Druckschwankungen. Bei Drucküberschreitungen oder Zuleitungsschluss erfolgt ein Warnsignal sowie ein Flowstop. Automatische Anzeige bei Gasmangel.

Neben der automatischen Selbsttest-Routine nach jedem Einschalten verfügt der nopaflow 30 I future 200 über eine automatische Fehlercode-Anzeige.

Technische Daten

Technische Änderungen zur Produktverbesserung vorbehalten.
Netz: umschaltbar auf 100-110/220-240VAC, 50/60Hz
Druckvorwahl: 4-25 mm Hg.
Gasfluss: 30 l/min
Gewicht: ca. 4,5 kg
Höhe: 145 mm
Breite: 300 mm
Tiefe: 320 mm

Bestelldaten

XU 142/00 nopaflow 30 I future 200 mit deutschem Anschluss für CO₂
XU 142/01 nopaflow 30 I future 200 mit amerikanischem Anschluss für CO₂
XU 142/02 nopaflow 30 I future 200 mit PIN-Index Anschluss für CO₂
XU 142/03 nopaflow 30 I future 200 mit italienischem Anschluss für CO₂

Jeweils einschließlich

XU 140/10 Schlüssel für CO₂ Flasche
XU 140/11 Netzanschlusskabel
XU 140/12 Insufflationsschlauch mit Anschlussstück
XU 140/13 High-Flow-Verres-Kanüle (LL)

Zubehör

XU 140/60 CO₂ Flasche deutsch
XU 140/70 CO₂ Flasche PIN-Index
XU 140/75 CO₂ Flasche ISO (auf Anfrage)
XU 140/90 Flaschenhalterung
XU 140/91 Flexibler Hochdruckschlauch 1m US-DT
XU 140/92 Flexibler Hochdruckschlauch 1m US-PIN-Index
XU 140/93 Flexibler Hochdruckschlauch 1m US-Italien
XU 141/10 Hygienefilter 5 Stück
XU 141/11 Schlauchadapter für Hygienefilter

Optional

V = Videoboard
T = CO₂ Vorwärmung

Description XU 142/00 - XU 142/03

The nopaflow 30 I future 200 ensures a safe introduction of the pneumoperitoneum during diagnostic and operative laparoscopy.

A high-tech processing unit for the pressure and flowcontrol guarantees a high accuracy for all instruments. The regulating speed is optimized by means of the safety technology mode (LPS/RGLC).

High application security is guaranteed by the extremely fast readjustment of pressure after pressure loss and consequent deviation control of pressure leakages without any pressure fluctuation. In case of exceeding pressure of supply clogging a warning signal and a flow-stop will be activated. Automatic display during loss of gas.

Besides automatic self-testing routine after every start, the nopaflow 30 I future 200 is equipped with an automatic error-code display. Maintenance of the system is easy, by means of operational instructions of the program.

Technical data

Technical specifications subject to change without notice.
Mains-supply: switchable 100-110/220-240VAC, 50/60Hz
Pressure pre-selection: 4-25 mm Hg
Gasflow: 30 l/min
Weight: approx. 4,5 kg
Height: 145 mm
Width: 300 mm
Depth: 320 mm

Reference data

XU 142/00 nopaflow 30 I future 200 with German connection for CO₂
XU 142/01 nopaflow 30 I future 200 with American connection for CO₂
XU 142/02 nopaflow 30 I future 200 with PIN-Index connection for CO₂
XU 142/03 nopaflow 30 I future 200 with Italian connection for CO₂

Including

XU 140/10 Wrench for CO₂ cylinder
XU 140/11 Mains supply connection cable
XU 140/12 Insufflating tube with connecting piece
XU 140/13 high-flow-verres cannula (LL)

Accessories

XU 140/60 CO₂ cylinder German
XU 140/70 CO₂ cylinder PIN-Index
XU 140/75 CO₂ cylinder ISO (on request)
XU 140/90 Cylinder holder
XU 140/91 flexible high pressure tubing 1m US-German
XU 140/92 flexible high pressure tubing 1m US-PIN-Index
XU 140/93 flexible high pressure tubing 1m US-Italian
XU 141/10 hygiene filter 5 pieces
XU 141/11 tube adapter for hygiene filter

Optional

V = Videoboard
T = CO₂ Therme

12
18
20
22

Insufflator
Insufflator
Insuffladores
Insufflateurs
Insufflator

nopa® flow 40 I future 200



Gasfluss: 40 L/min.
Gasflow: 40 L/min.

XU 150/00 - 150/03

Beschreibung XU 150/00 - XU 150/03

Der nopaflow 40 I future 200 ermöglicht eine sichere Anlage des Pneumoperitoneums während der diagnostischen und operativen Laparoskopie.

Durch moderne prozessorgesteuerte Druck- und Flowregelung ergibt sich eine hohe Regelgenauigkeit, sowohl bei herkömmlichen als auch bei strömungstechnisch weiterentwickelten Instrumenten. Die Regelschnelligkeit ist optimiert durch den Insufflationsmodus (LPS/RGLC).

Eine hohe Applikationssicherheit ist garantiert durch die extrem schnelle Nachregelung des Druckes bei Druckverlust sowie die konsequente Ausregelung von Leckagen ohne störende Druckschwankungen. Bei Drucküberschreitungen oder Zuleitungsschluss erfolgt ein Warnsignal sowie ein Flowstop. Automatische Anzeige bei Gasmangel.

Neben der automatischen Selbsttest-Routine nach jedem Einschalten verfügt der nopaflow 40 I future 200 über eine automatische Fehlercode-Anzeige.

Technische Daten

Technische Änderungen zur Produktverbesserung vorbehalten.

Netz: umschaltbar auf 100-110/220-240VAC, 50/60Hz
Druckvorwahl: 4-25 mm Hg.
Gasfluss: 40 l/min
Gewicht: ca. 4,5 kg
Höhe: 145 mm
Breite: 300 mm
Tiefe: 320 mm

Bestelldaten

XU 150/00 nopaflow 40 I future 200 mit deutschem Anschluss für CO₂
XU 150/01 nopaflow 40 I future 200 mit amerikanischem Anschluss für CO₂
XU 150/02 nopaflow 40 I future 200 mit PIN-Index Anschluss für CO₂
XU 150/03 nopaflow 40 I future 200 mit italienischem Anschluss für CO₂

Jeweils einschließlich

XU 140/10 Schlüssel für CO₂ Flasche
XU 140/11 Netzanschlusskabel
XU 140/12 Insufflationsschlauch mit Anschlussstück
XU 140/13 High-Flow-Verres-Kanüle (LL)

Zubehör

XU 140/60 CO₂ Flasche deutsch
XU 140/70 CO₂ Flasche PIN-Index
XU 140/75 CO₂ Flasche ISO (auf Anfrage)
XU 140/90 Flaschenhalterung
XU 140/91 Flexibler Hochdruckschlauch 1m US-DT
XU 140/92 Flexibler Hochdruckschlauch 1m US-PIN-Index
XU 140/93 Flexibler Hochdruckschlauch 1m US-Italien
XU 141/10 Hygienefilter 5 Stück
XU 141/11 Schlauchadapter für Hygienefilter

Optional

V = Videoboard
T = CO₂ Vorwärmung

Description XU 150/00 - XU 150/03

The nopaflow 40 I future 200 ensures a safe introduction of the pneumoperitoneum during diagnostic and operative laparoscopy.

A high-tech processing unit for the pressure and flowcontrol guarantees a high accuracy for all instruments. The regulating speed is optimized by means of the safety technology mode (LPS/RGLC).

High application security is guaranteed by the extremely fast readjustment of pressure after pressure loss and consequent deviation control of pressure leakages without any pressure fluctuation. In case of exceeding pressure of supply clogging a warning signal and a flow-stop will be activated. Automatic display during loss of gas.

Besides automatic self-testing routine after every start, the nopaflow 40 I future 200 is equipped with an automatic error-code display. Maintenance of the system is easy, by means of operational instructions of the program.

Technical data

Technical specifications subject to change without notice.

Mains-supply: switchable 100-110/220-240VAC, 50/60Hz
Pressure pre-selection: 4-25 mm Hg
Gasflow: 40 l/min
Weight: approx. 4,5 kg
Height: 145 mm
Width: 300 mm
Depth: 320 mm

Reference data

XU 150/00 nopaflow 40 I future 200 with German connection for CO₂
XU 150/01 nopaflow 40 I future 200 with American connection for CO₂
XU 150/02 nopaflow 40 I future 200 with PIN-Index connection for CO₂
XU 150/03 nopaflow 40 I future 200 with Italian connection for CO₂

Including

XU 140/10 Wrench for CO₂ cylinder
XU 140/11 Mains supply connection cable
XU 140/12 Insufflating tube with connecting piece
XU 140/13 high-flow-verres cannula (LL)

Accessories

XU 140/60 CO₂ cylinder German
XU 140/70 CO₂ cylinder PIN-Index
XU 140/75 CO₂ cylinder ISO (on request)
XU 140/90 Cylinder holder
XU 140/91 flexible high pressure tubing 1m US-German
XU 140/92 flexible high pressure tubing 1m US-PIN-Index
XU 140/93 flexible high pressure tubing 1m US-Italian
XU 141/10 hygiene filter 5 pieces
XU 141/11 tube adapter for hygiene filter

Optional

V = Videoboard
T = CO₂ Therme

Saug/Spül System
Suction Irrigation System
Sistema de succión y irrigación
Système d'aspiration/de lavage
Sistema d'aspirazione ed irrigazione

nopa® suction irrigation system

XU 310/00



Beschreibung XU 310/00

- Höchstes Leistungsniveau
- Absaugen/Spülen mit bis zu 3 l/min
- Großer Absaugbehälter
- Standby-Funktion für minimalen Verschleiß
- Optimalste Sterilbedingungen durch spezielle Filter
- Einfaches, ergonomisches Bedienkonzept
- Variable Flaschenposition (am Gerät oder Gerätewagen)
- Keine Einstellarbeiten – Saug- und Spüleistung individuell am Instrument regelbar
- Integrierter Überlaufschutz
- Geringer Geräuschpegel durch Stand-by-Funktion
- Qualitativ hochwertige Bauteile

Technische Daten

Netzspannung:	100-115VAC 220-240VAC
Leistungsaufnahme:	120VA
Frequenz:	50/60Hz
Spüleistung:	bis 3000 ml/min
Schutzklasse:	I
Nach Med.-Produkte-Richtl.:	CE 0483
Gewicht:	ca. 4,7 kg
Abmessung: H x B x T	14,5 x 30,0 x 32,0 cm

XU 310/00

Saug/Spül System inklusiv

XU 310/91	Schlauchset mit LL-Anschlüssen
XU 310/92	Einstechrohr
XU 310/93	2 x Flaschenhalter
XU 310/94	Mikrofilter
XU 310/95	Netzkabel
XU 310/96	2 Liter-Absaug-Behälter inkl. Saugdeckel

Description XU 310/00

- Highest efficiency
- Aspirates and irrigates at up to 3 l/min
- Large two-liter aspiration container
- Standby function minimizes wear and tear
- Special filters ensure sterility
- Simple ergonomic operation
- Flask may be attached to unit or carrier cart
- No special adjustment necessary. Aspiration and irrigation are regulated and selected by the instrument controls
- Integrated overflow protection
- Standby function for low noise level
- High-quality components

Technical data

Line voltage:	100-115VAC 220-240VAC
Power consumption:	120VA
Frequency:	50 / 60Hz
Rinsing performance:	up to 3000 ml/min
Protection class:	I
Acc. To MDD:	CE 0483
Weight:	approx. 4,7 kg
Dimension: H x W x D	14,5 x 30,0 x 32,0 cm

XU 310/00

Suction irrigation system including

XU 310/91	tubing set with LL connections
XU 310/92	puncture tube
XU 310/93	2 x bottle holders
XU 310/94	microfilter
XU 310/95	power cord
XU 310/96	2 liter container incl. suction lid
Technical specifications subjects to change without notice.	

VERSCHIEDENES
VARIOUS ITEMS
ARTICULOS DIVERSOS
ARTICLES DIVERS
ARTICULOS DIVERSI

22

nopa[®] instruments



Gelenkarmsystem mit zentraler Schnellfixierung
 Articulated arm with quick central fixation
 Sistema de brazo articulado con fijación rápida central
 Système de bras articulé avec fixage rapide central
 Sistema a braccio articolato con fissaggio rapido centrale

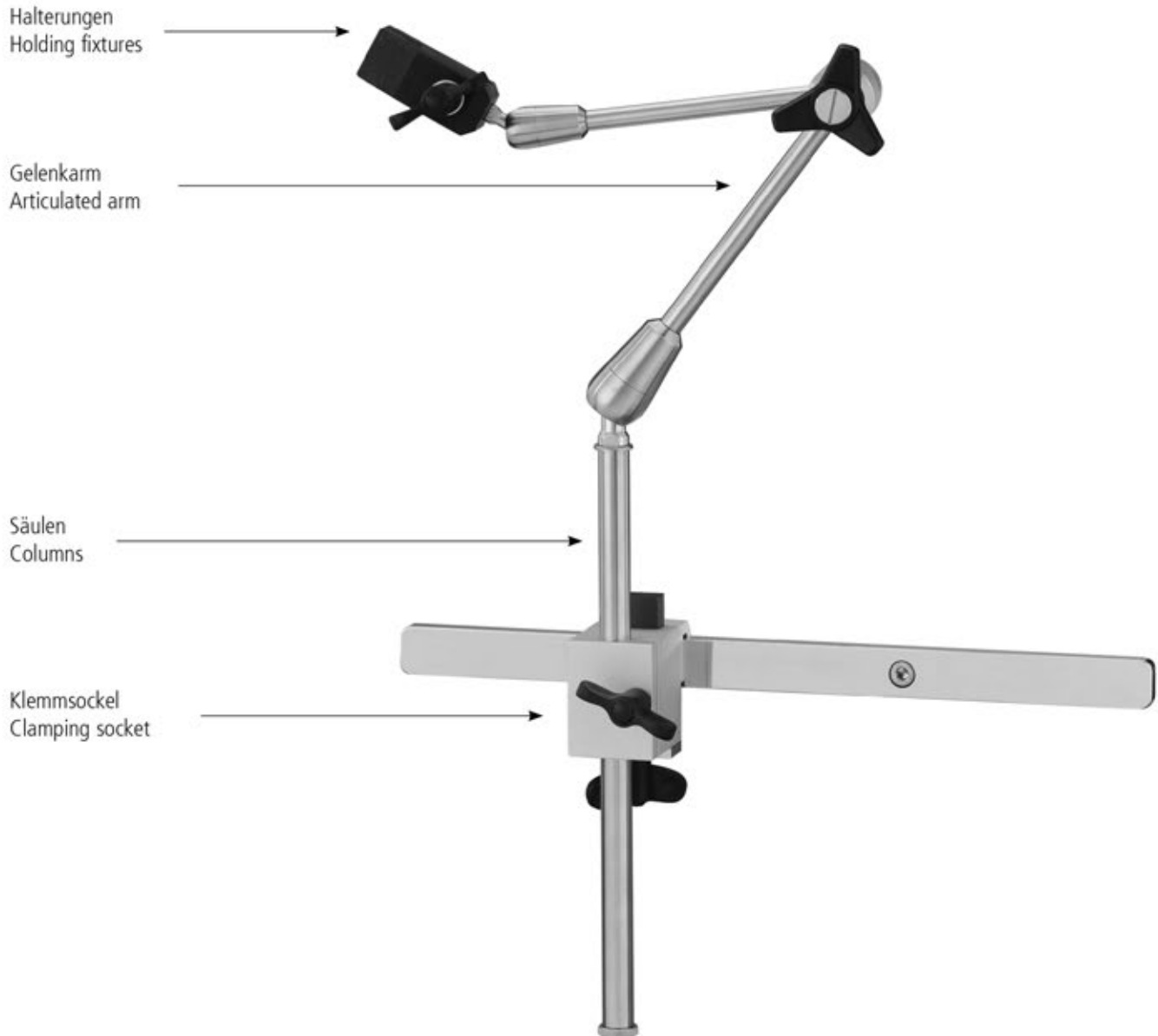

Komplett kurz / short complete

XU 650/01 = XU 650/13
 XU 650/40
 XU 651/01
 XU 651/12

Komplett lang / long complete

XU 650/02 = XU 650/13
 XU 650/55
 XU 651/02
 XU 651/12

Zubehör auf der Rückseite
 Accessories reverse side

Gelenkarmsystem mit zentraler Schnellfixierung
 Articulated arm with quick central fixation
 Sistema de brazo articulado con fijación rápida central
 Système de bras articulé avec fixation rapide central
 Sistema a braccio articolato con fissaggio rapido centrale

**Halterungen
 Holders**



XU 650/11
 Kombi Instrumentenhalter
 Combined Instrument holder



XU 650/12
 Ø 4 mm Optikhalter
 Ø 4 mm Optic holder



XU 650/13
 Ø5 mm/10 mm Optikhalter
 Ø5 mm/10 mm Optic holder



XU 650/14
 Ø 8 mm Optikhalter
 Ø 8 mm Optic holder

**Gelenkarme
 Articulated arms**

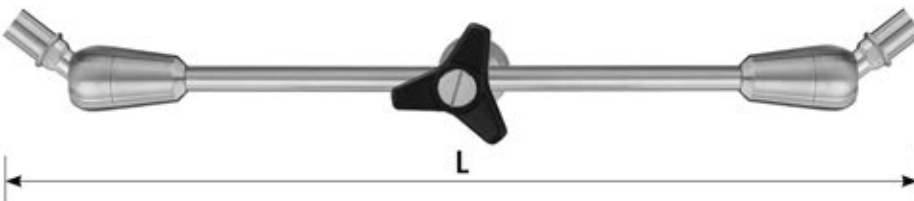

XU 650/40
 L = 400 mm M8/M12x1 Ø16 mm

XU 650/55
 L = 550 mm M8/M12x1 Ø16 mm

**Säulen
 Columns**



XU 651/01 Ø16 mm 300 mm
 XU 651/02 Ø16 mm 400 mm



XU 651/03
 Ø16 mm 450 mm x 100 mm



XU 651/04
 Ø16 mm 266 x 300 x 116 mm

**Klemmsockel
 Clamping socket**



XU 651/11
 Universalsocket
 Universal clamp



XU 651/12
 Schienensockel
 Rails clamping socket



XU 651/13
 Isolierter Schienensockel
 Insulated rails clamping socket

nopa® mobil

economy



XU 800/30

Höhe/Height:	1440 mm
Breite/Width:	700 mm
Tiefe/Depth:	620 mm
Belastung per Platte/ Load worktop:	max. 35 kg

Ohne Stromversorgung / Without power supply

nopa[®] mobil

XU 800/40

Höhe/Height: 1440 mm
Breite/Width: 700 mm
Tiefe/Depth: 620 mm

Belastung per Platte/
Load worktop: max. 40 kg

Reinigungsbürsten
 Cleaning brushes
 Cepillos de limpieza
 Broses pour nettoyer
 Spazzoli per pulire

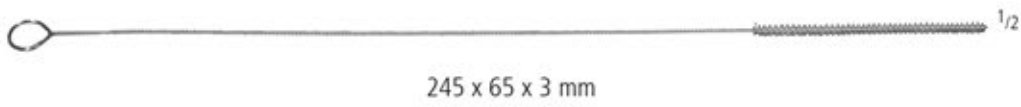
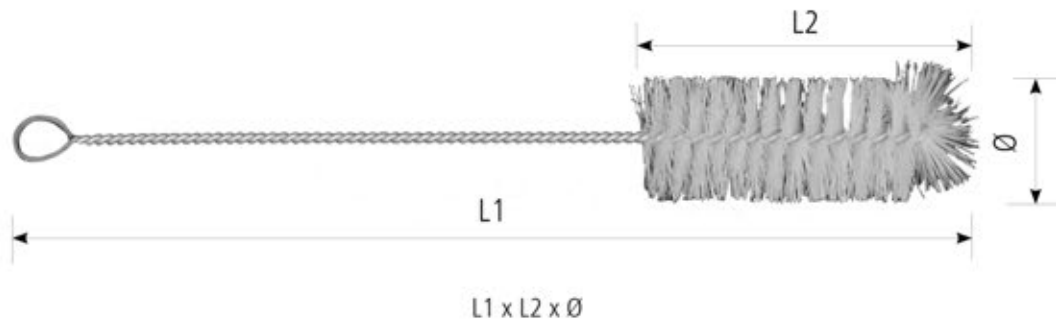

KY 800/03

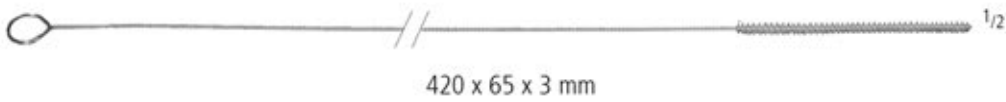

KY 801/03

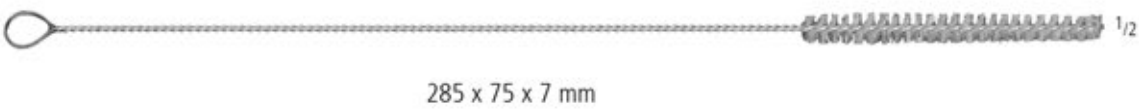

KY 802/07

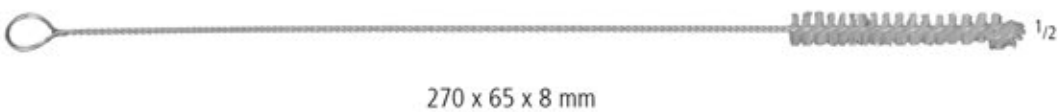

KY 803/08

Reinigungsbürsten
 Cleaning brushes
 Cepillos de limpieza
 Brosses pour nettoyer
 Spazzoli per pulire

12
18
20

22



270 x 65 x 12 mm

KY 803/12



215 x 60 x 13 mm

KY 803/13



215 x 70 x 15 mm

KY 803/15



215 x 65 x 20 mm

KY 803/20



215 x 65 x 25 mm

KY 803/25



215 x 65 x 30 mm

KY 803/30

Reinigungsbürsten
 Cleaning brushes
 Cepillos de limpieza
 Brosses pour nettoyer
 Spazzoli per pulire



KY 804/00 = KY 805/13
 KY 805/15
 KY 805/20
 KY 805/25
 KY 805/28



215 x 60 x 13 mm

KY 805/13



215 x 65 x 15 mm

KY 805/15

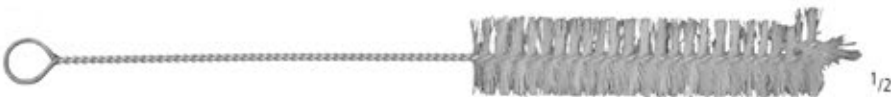

215 x 95 x 20 mm

KY 805/20



215 x 95 x 25 mm

KY 805/25



215 x 100 x 28 mm

KY 805/28

ENDOSKOPIE ENDOSCOPY ENDOSCOPIA ENDOSCOPIE ENDOSCOPIA

Reinigungsbürsten
 Cleaning brushes
 Cepillos de limpieza
 Broses pour nettoyer
 Spazzoli per pulire

12

18

20

22



275 x 65 x 12 mm

KY 806/12



275 x 80 x 15 mm

KY 806/15



300 x 120 x 30 mm

KY 806/30



320 x 130 x 50 mm

KY 806/50



360 x 140 x 35 mm

KY 807/35



420 x 180 x 40 mm

KY 808/40

Reinigungsbürsten
 Cleaning brushes
 Cepillos de limpieza
 Brosses pour nettoyer
 Spazzoli per pulire

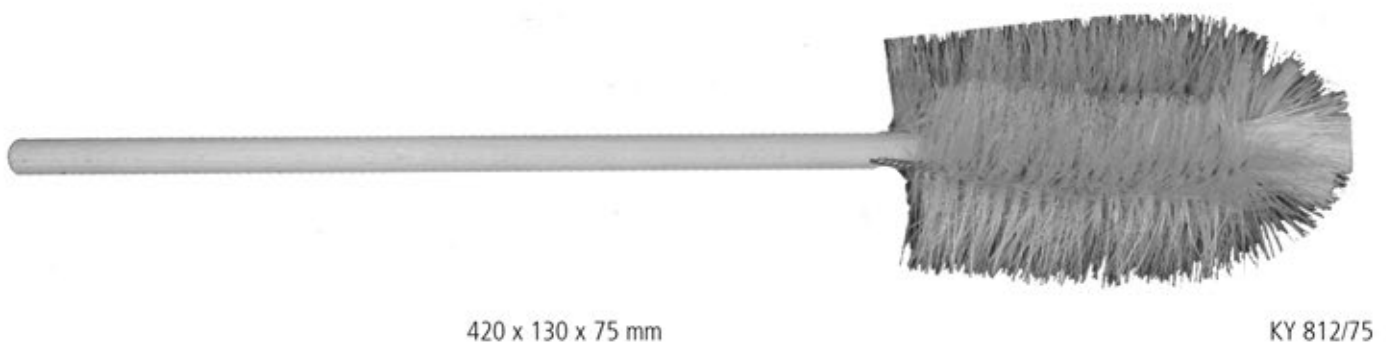
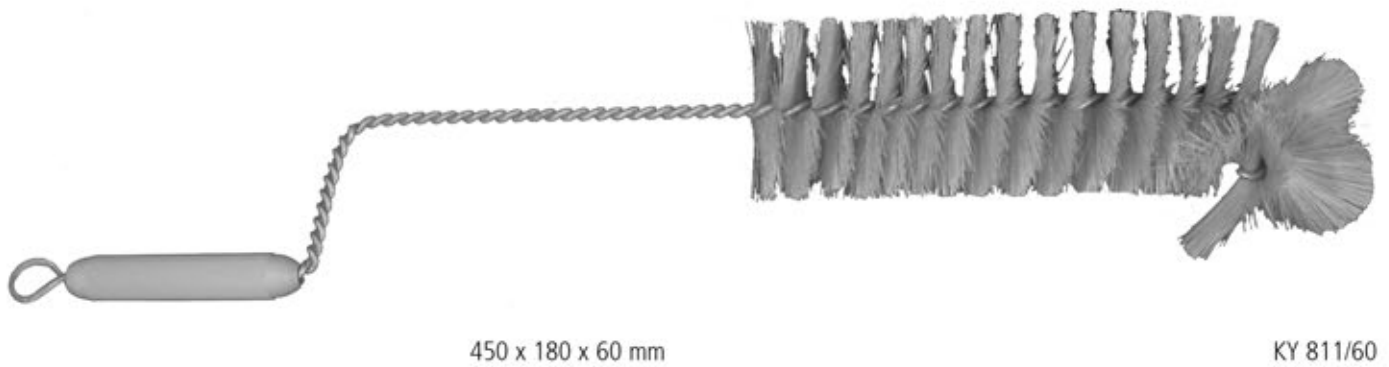
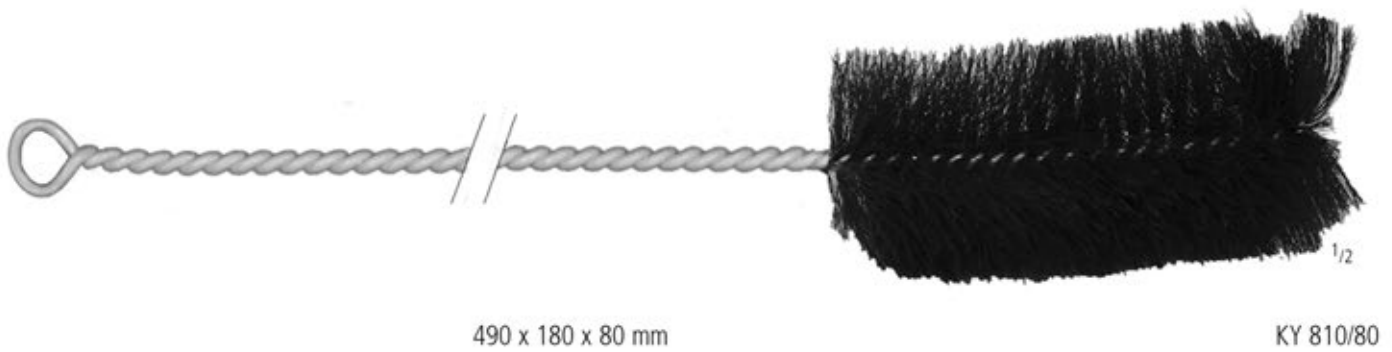
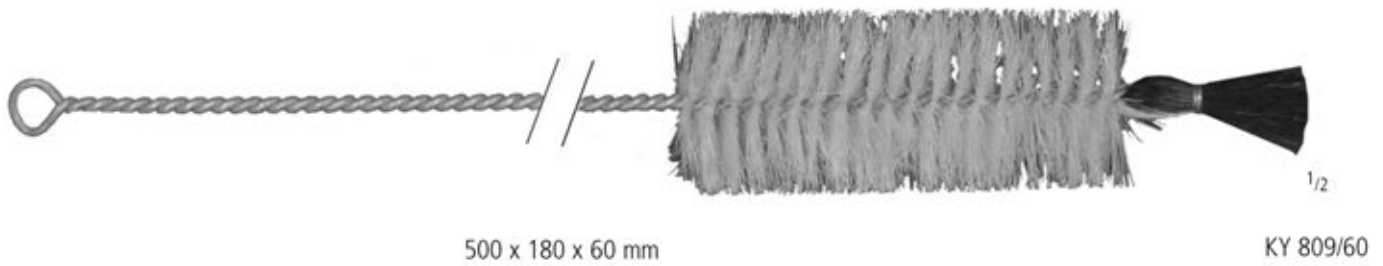

Reinigungsbürsten
 Cleaning brushes
 Cepillos de limpieza
 Brosses pour nettoyer
 Spazzoli per pulire

12
18
20
22

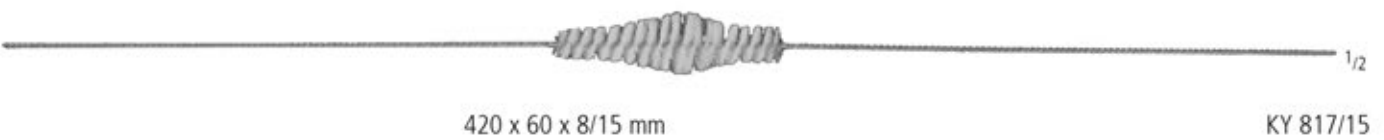
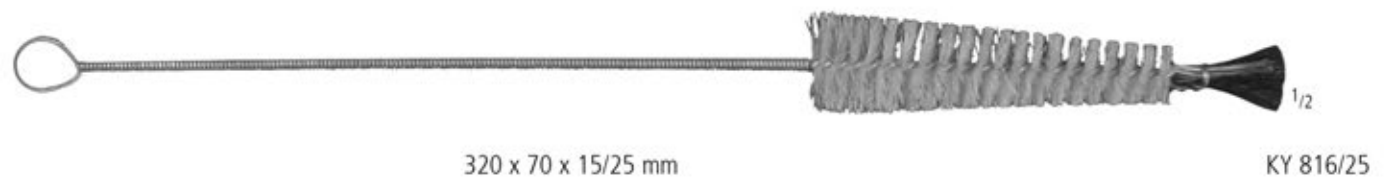
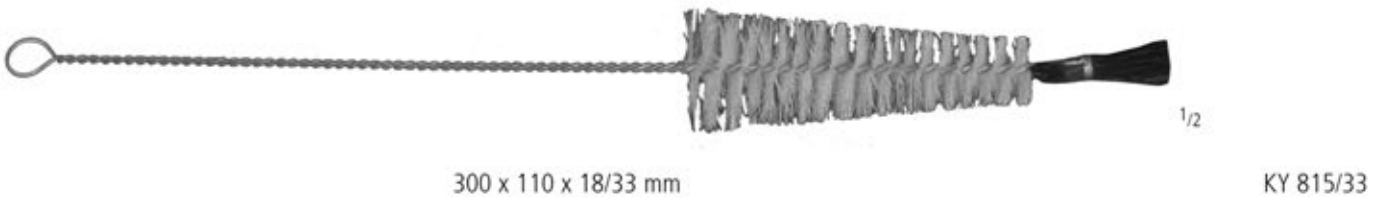
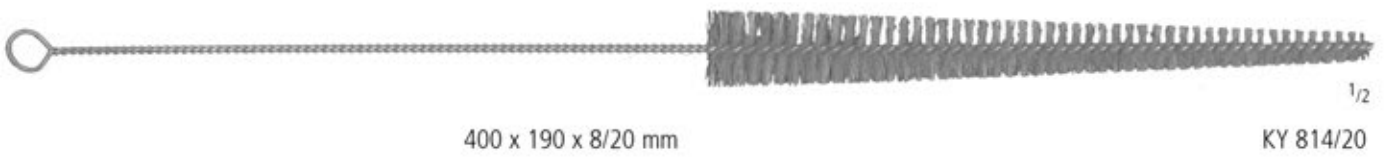
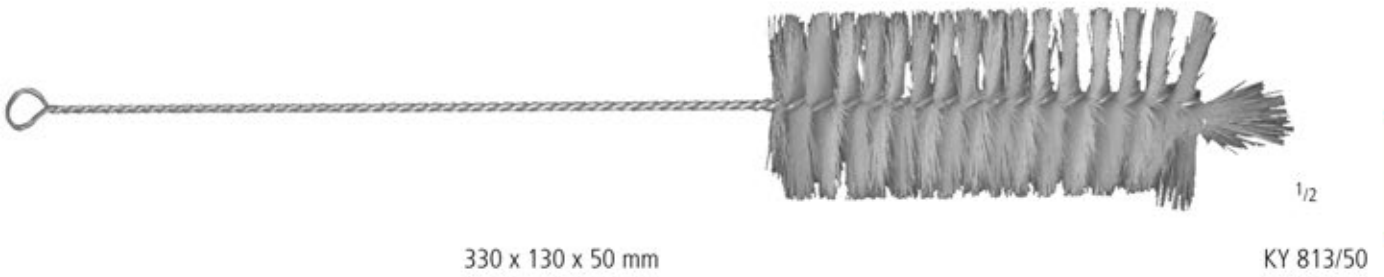

Reinigungsbürsten
 Cleaning brushes
 Cepillos de limpieza
 Broses pour nettoyer
 Spazzoli per pulire

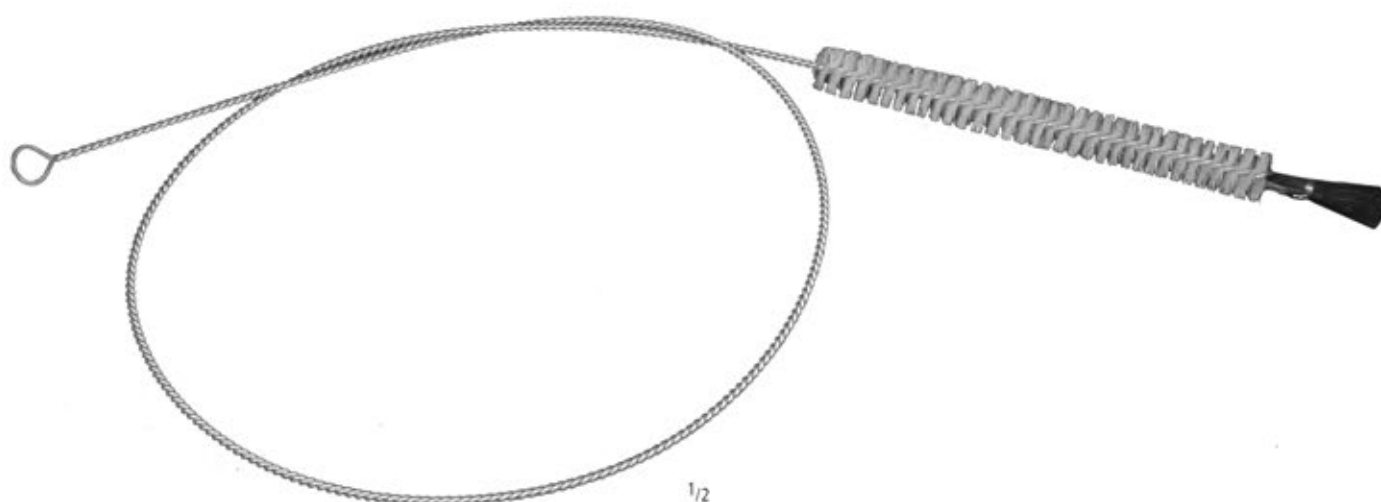

1/2

1000 x 180 x 16 mm

KY 818/16



1/2

210 x 95 mm

KY 819/95

Reinigungspistole
 Spray gun
 Pistola lavatoria
 Pistolet laveur
 Pistola lavatrice

12

18

20

22



KY 940/01

KY 940/00

Reinigungspistole und Ansatzset komplett KY 940/01 + KY 945/00
 Spray gun and set of attachment complete KY 940/01 + KY 945/00
 Pistola lavatoria y set de toberas completo con KY 940/01 + KY 945/00
 Pistolet laveur et set d'embouts complet avec KY 940/01 + KY 945/00
 Pistola lavatrice e set di to raccordi completo con KY 940/01 + KY 945/00

Die nopa Reinigungspistole ist das ideale Werkzeug für die Reinigung von Laborgläsern, Pipetten, Spritzen, Kathetern, Küvetten, Endoskopen, Cystoskopen, Kanülen und anderen Gegenständen in Klinik, Labor und Praxis – also überall dort, wo es auf höchste Sauberkeit und Hygiene ankommt.

Die Reinigung erfolgt mit Wasser oder Druckluft besonders schnell, effizient und damit kostensparend.

Bei der neuen nopa Reinigungspistole ist der Wasser- oder Luftstrahl durch eine neuartige Dosiermechanik stufenlos über die gesamte Betätigungsstrecke des Abzughahns fein dosierbar.

Der maximale Wasser- oder Luftfluss kann auch mit der kleinen Rändelschraube hinter dem Abzughahn individuell eingestellt werden.

The nopa Spray Gun is the ideal instrument for cleaning laboratory glassware, pipettes, syringes, catheters, cuvettes, endoscopes, cystoscopes, cannulae and a variety of other instruments and articles used in clinics, laboratories, and medical practices – in other words, everywhere where highest cleanliness and hygiene are mandatory.

The nopa Spray Gun uses either water or pressurized air – this means the cleaning process is quick, efficient and inexpensive.

The nopa Spray Gun features a new type of internal flow control mechanism. It permits the smooth and simple adjustment of the water or air flow across the entire range of the trigger movement.

The desired maximum water or air flow can be set by using the small knurled screw located behind the trigger. It is then regulated via the trigger up to the set maximum value.

Reinigungspistole
 Spray gun
 Pistola lavatoria
 Pistolet laveur
 Pistola lavatrice

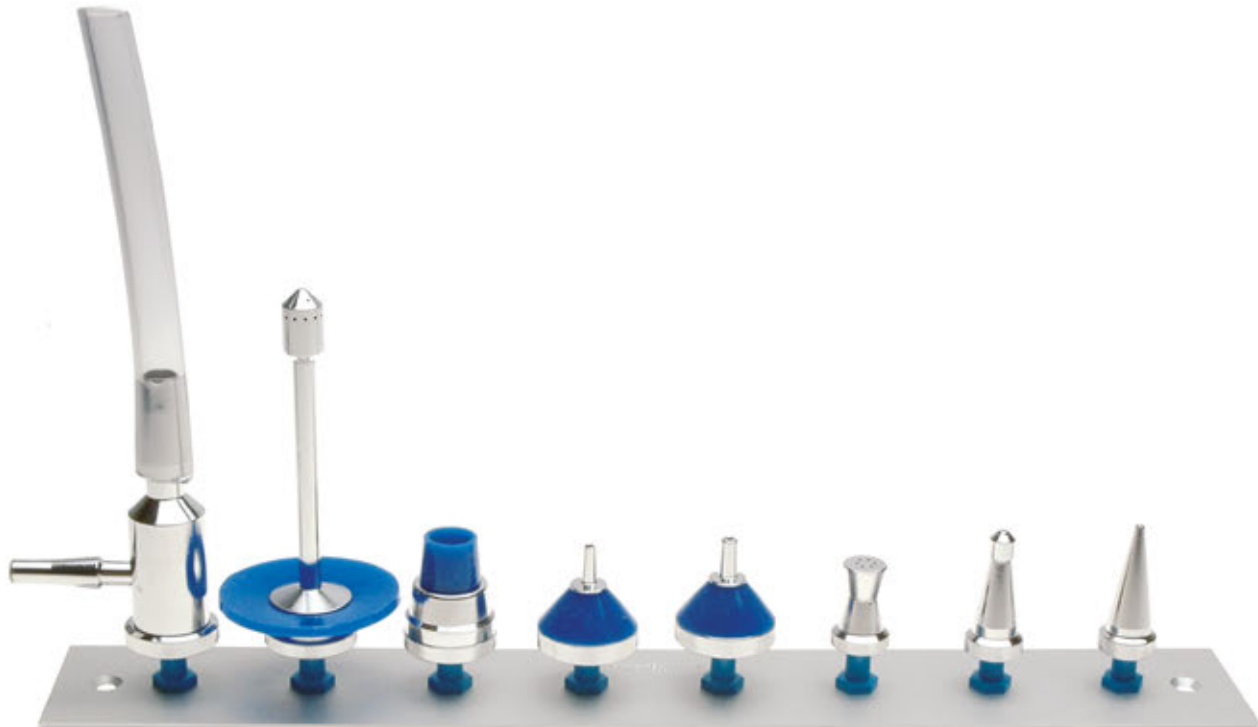

Fig.1
 KY 945/01

Fig.2
 KY 945/02

Fig.3
 KY 945/03

Fig.4
 KY 945/04

Fig.5
 KY 945/05

Fig.6
 KY 945/06

Fig.7
 KY 945/07

Fig.8
 KY 945/08

KY 945/00 = KY 945/01
 KY 945/02
 KY 945/03
 KY 945/04
 KY 945/05
 KY 945/06
 KY 945/07
 KY 945/08

>> Spülen, Saugen und Trocknen für die unterschiedlichsten Einsatzgebiete wird durch ein Sortiment von 8 Ansätzen ermöglicht.

>> Das Standard-Set mit 8 Ansätzen wird auf einer stabilen Aufsteckleiste für die Wandmontage geliefert. Damit ist jedes Einzelteil sicher und griffbereit aufbewahrt.

>> Rinsing, suction or drying in every area of application is made possible through the set of 8 attachments.

>> The standard set of 8 attachments is delivered on a stable storage rack for mounting on the wall. All attachments are kept within easy reach.

Inhaltsverzeichnis

	Seite		Seite
A			
Abortus- und Plazentanzangen	384	Beckenzirkel	382
Abortuslöffel	384	BECKMANN, selbsthaltende Wundsperrerr	274
Absaug- und Biopsieküretten	361	BECKMANN-ADSON, selbsthaltende Wundsperrerr	275
Abszessmesser	207	BECKMANN-EATON, selbsthaltende Wundsperrerr	275
ACKERMANN, Areola Markierer	397	BENGOLEA, Arterienklemmen	116
ADAMS-MAYO, selbsthaltende Wundsperrerr	278	BERGER, Uterus-Biopsiezangen	368
ADLERKREUTZ, Pinzetten	147	BERNHARD, Tuchklemmen	133
ADSON, selbsthaltende Wundsperrerr	272, 273	Beschneidungsinstrumente	415
ADSON, Arterienklemmen	115	BILLROTH, Wundhaken	252
ADSON, Hartmetallpinzetten TUC	156	Biopsie- und Absaugküretten	361
ADSON, Pinzetten	141, 142	Biopsie- und Saugküretten	360, 361
ADSON, Saugrohre	301	Biopsiezangen-Uterus	362-369
ADSON-ANDERSON, selbsthaltende Wundsperrerr	272	BIRKETT, Präparier- und Ligaturklemmen	127
ADSON-BABY, Arterienklemmen	115	BLAKE, Gallensteinzangen	406
ADSON-BABY, selbsthaltende Wundsperrerr	274	BLAKE, Uterusküretten	376
ADSON-BECKMANN, selbsthaltende Wundsperrerr	275	Blasenspatel	413
ADSON-BROWN, Pinzetten	142	Blasen-Wundspreizer	411-413
ADSON-MICRO, Pinzetten	141	Blutdruckmessapparate	328, 329
ADSON-TOENNIS-DELICATE, Hartmetallscheren TUC	196	BONNEY, Fasspinzetten	150
ADVENTITIA, Mikroscheren	181, 183	BONNEY, Hartmetallpinzetten TUC	157
AGRIS-DINGMAN, Brustdissektoren	396	Boomerang Nadelhalter	213
ALEXANDER, Uterus-Biopsiezangen	367	BOZEMANN, Nahtinstrumente	232
ANDERSON-ADSON, selbsthaltende Wundsperrerr	272	BOZEMANN, Tupferzangen	241
ANDREWS-PYNCHON, Saugrohre	298	BOZEMANN-DOUGLAS, Tupferzangen	241
Areola Markierer	397	BRAUN, Dekapitationshaken	385
Arterienklemmen	106-113, 115, 116	BRAUN, Hakenzangen	354
Arterienklemmen, grazil	112	BRAUN, Kranioklast	386
Atraumatische Pinzetten	154	BRAUN, Uterusdepressoren	353
AUSTIN, Knüpppinzetten	152	BRAUN-STADLER, Episiotomiescheren	173
AUVARD, Scheidenspekula	342	BREISKY, Scheidenhalter	343
AYRE, Mynommesser	208	BRIDGE, Präparier- und Ligaturklemmen	120
AYRE, Myom-Instrumente	357	BRODIE, Sonden	292
B			
BABY-ADSON, Arterienklemmen	115	BROPHY (SULLIVAN), feine Scheren	175
BABY-ADSON, selbsthaltende Wundsperrerr	274	BROPHY, Pinzetten	145
BABY-BALFOUR, Bauchdeckenhalter	281	BROWN, Pinzetten	146
BABY-COLLIN, Bauchdeckenhalter	283	BROWN-ADSON, Pinzetten	142
BABY-CRILE-WOOD, Hartmetallnadelhalter TUC	218	BRUNNER, Führungshohlsonden	229
BABY-LEXER, Präparierschere	171	BRUNNER, Unterbindungsnadeln	225, 226
BABY-LIGHTWEIGHT-DUPLEX, Stethoskop	327	BRUNNER, Wundhaken	259
BABY-METZENBAUM, Präparierschere	168	BRUNNER-FERROZELL, Führungshohlsonden	231
BABY-MIXTER, Präparier- und Ligaturklemmen	119	Brustdissektoren	394-396
BABY-OVERHOLT, Präparier- und Ligaturklemme	113	Brustretrektoren	390-393
BABY-POOLE, Saugrohre	299	BUCK, Ligaturscheren	178
BABY-TISCHLER, Uterus-Biopsiezangen	363	BUMM, Uterusküretten	375
BACKHAUS, Tuchklemmen	134	BURKE, Uterus-Biopsiezangen	362
BAKES, Gallenkanal-Dilatatoren	405	BUSCH, Nabelschnurscheren	173
BALFOUR, Bauchdeckenhalter	281, 282	BYRD, Saugrohre	299
BALFOUR-BABY, Bauchdeckenhalter	281	C	
BALFOUR-US-TYPE, Bauchdeckenhalter	281	CAIRNS, Arterienklemmen	112
BALL & SOCKET, Tuchklemmen	134	Caliper	325
BALLANTINE-HEANEY, Hysterektomieklappen	129	CANNY RYALL, Wundhaken	269
BALLENGER-FOERSTER, Schwammzangen	244	CARDINALE, Gynäkologische Scheren	167
BARRAYA-STILLE, Pinzetten	147	CARDINALE, Hartmetallscheren TUC	191
BARRETT, Hakenzangen	354	CARDIOPHON, Stethoskop	327
Basiotrib	386	CAROLL, Goniometer	325
Bauchdeckenhalter	280-286	CARREL, Arterienklemme	106
Bauchdeckenscheren	166	Chirurgische Scheren	162-165, 174
Bauchspatel	287	CLAR 55, Stirnlampen	324
BAUMGARTNER, Nadelhalter	210	CLAR STANDARD, Stirnlampen	324
BEACHAM, Instrument für die Amnionblase	387	CLAUS, Unterbindungsnadeln	227
		CLAUS-EICKEN, Unterbindungsnadeln	228
		COHEN, Uterussonden	372
		COLLER, Arterienklemmen	109

	Seite		Seite
COLLIN, Bauchdeckenhalter	283, 284	DOYEN, Tuchklemmen	133
COLLIN, Nabelschnurklemmen	388	DOYEN-STILLE, Wundhaken	262
COLLIN, Nierenfasszange	403	DUBOIS, Gynäkologische Scheren	167
COLLIN, Scheidenspekula	334	DUEHRSEN, Pinzetten	146
COLLIN, Skalpelle	205	DUNHILL, Arterienklemme	112
COLLIN, Skalpellgriffe	202	DUPLAY, Hakenzangen	354
COLLIN, Uterusküretten	376	DUPLEX-LIGHTWEIGHT/BABY, Stethoskope	327
COLLIN-BABY, Bauchdeckenhalter	283	DURANTE, Fasspinzetten	150
COLLIN-DUVAL, Fasspinzette	148	DUVAL, Fasspinzetten	150
COLLIN-HARTMANN, Wundhaken	267	DUVAL-COLLIN, Fasspinzetten	148
CONE KNIFE, Mynommesser	208		
CONE, selbsthaltende Wundsperrerr	274	E	
Container Systeme	427-448	EASTMAN-RICHARDSON, Wundhaken	260
COOLEY, Gefäßdilatoren	294	EATON-BECKMANN, selbsthaltende Wundsperrerr	275
COOLEY, Saugrohre	300	EICKEN-CLAUS, Unterbindungsadeln	228
COOPER, Unterbindungsadeln	225	EICKEN-KILLIAN, Saugkanüle	301
CORYLLOS, Wundhaken	266	Einführungsinstrumente	414
COUPLAND, Saugrohre	299	EISELSBERG, Ligaturscheren	177
CRILE, Arterienklemmen	109	EMMET, Fistelhaken	359
CRILE-RANKIN, Arterienklemmen	109	Endoskopie, Pelviskopie	372
CRILE-WOOD, Hartmetallnadelhalter TUC	218	Endoskopie, Pelviskopie	372
CRILE-WOOD-BABY, Hartmetallnadelhalter TUC	218	Endoskopie, Pelviskopie	372
CULLEN-WERTHEIM, Hysterektomieklappen	131	Endoskopie, Pelviskopie	372
CUSCO, Scheidenspekula	333, 338	ENGLISCHES MODELL, Tuchklemmen	133
CUSCO, Scheidenspekula mit Absaugung	338	Episiotomiescheren	173
CUSCO-SUISSE, Scheidenspekula	333	EPPENDORF, Uterus-Biopsiezangen	368, 369
CUSCO-VIRGIN, Scheidenspekula	333	EUFRATE PASQUE, Hartmetallnadelhalter TUC	217
CUSHING, feine Wundhaken	246, 249	EWALD, Pinzetten	142
CUSHING, Hartmetallpinzetten TUC	156		
CUSHING, Pinzetten	144	F	
CUSHING-TAYLOR, Hartmetallpinzetten TUC	156	Face-Lift-Schere TUC	196
CZERNY, Wundhaken	269	Fadenfänger	232
		Fadenknöter	232
D		Fadenschlingendreher	232
DARLING, selbsthaltende Wundsperrerr	277	FALK, Unterbindungsadeln	228
DARTIGUES, Uterus-Fasszangen	358	FARABEUF, Wundhaken	268
DE BAKEY, Atraumatische Pinzetten	154	FARRELL, Watteträger	292
DE BAKEY, Gefäßdilatoren	295	Fasspinzetten	148-151
DE BAKEY, Hartmetallnadelhalter TUC	216	Fasszangen	296
DE BAKEY, Hartmetallpinzetten TUC	157	FAURE, Hysterektomieklappen	131
DE BAKEY, Saugrohre	298	FAURE, Uterus-Biopsiezangen	364
DE LA ROZA, Unterbindungsadeln	226	FEIN, Watteträger	293
DE LEE, Geburtszangen	383	Feine Arterienklemmen	107
DEAVER, Chirurgische Scheren	164	Feine Scheren	176
DEAVER, Wundhaken	263-265	Feine Wundhaken	246-250
Dekapitationshaken	385	FERGUSSON, Chirurgische Scheren	164
DESCHAMPS, Unterbindungsadeln	224	FERGUSSON, Saugrohre	301
DESJARDINS, Gallenkanalklemmen	126	FERREIRA, Brustretractor	391
DESJARDINS, Gallensteinlöfler	407	FERRIS-SMITH, Pinzetten	147
DESJARDINS, Gallensteinsonden	405	FERROZELL, Führungshohlsonden	231
DESJARDINS, Gallensteinzangen	406	FERROZELL-BRUNNER, Führungshohlsonden	231
DESMARRES, feine Wundhaken	249	FERROZELL-KIRSCHNER, Führungshohlsonden	231
Diagnostik	321-329	FIBRE OPTIC, Kaltlichtlaryngoskope	316
DIEFFENBACH, Abszessmesser	207	FINOCCHIETTO, Nadelhalter	211
DIEFFENBACH, Skalpelle	206	FINOCCHIETTO, Nierenstielklemmen	123
Dilatationsbesteck	416	Fistelhaken	359
Dilatationsbougies	417	Fistelmesser	207
Dilatatoren, Gefäß-	294, 295	Fistelschere	166
Dilatatoren-Uterus	346-351	FOERSTER-BALLENGER, Schwammzangen	244
DIPLOMAT, Blutdruckmessapparate	328	FOMON, Präparierschere	171
DISSECTION, Mikroschere	181, 183	FOREGGER-WISCONSIN FIBRE OPTIC, Laryngoskope	314
Dissektoren, Brust	394-396	FOREGGER-WISCONSIN, Laryngoskope	310
DOUAY, Uterus-Biopsiezangen	369	FRANKENFELDT, Fasszange	296
DOUGLAS-BOZEMANN, Tupferzangen	241	FRAZIER, Saugrohre	301
DOYEN, Myom-Instrumente	357	FREEMAN, Areola Markierer	397
DOYEN, Scheidenspekula	341	FREEMAN, Brustretractor mit Kaltlichtbeleuchtung	402
DOYEN, Schere	166	FRENCH-EYE-RYDER, Hartmetallnadelhalter TUC	217
DOYEN, Sonden	291	FRIEDMANN, Vulvaspreizer	344
		FRIEDRICH, Nahtinstrumente	232

	Seite		Seite
FRITSCH, Wundhaken	262	HEGAR-OLSEN, Hartmetallnadelhalter TUC	220
Führungshohlsonden	229-231	HEGAR-OLSEN, Nadelhalter	211
Führungsnadeln	303	HEIFETZ, Pinzetten	151
G		HENLEY, selbsthaltende Wundperrerr	270
Gallenkanal-Dilatatoren	405	HENROTIN, Hakenzangen	356
Gallenkanalklemmen	123, 126	HERRICK, Nierenstielklemmen	125
Gallensteinlöffel	407	HESSBERG, Unterbindungsnadeln	226
Gallensteinsonden	405	HOESEL, Wundhaken	261
Gallensteinzangen	406	HOLINGER, Laryngoskope	318
GARLAND, Hysterektomieklemmen	130	HOPKINS-JOHNS, Präparier- und Ligaturklemmen	118
GARRETT, Gefäßdilatatoren	294	HORNE-JOBSON, Watteträger	293
Geburtszangen	382, 383	HOSPITAL-PROVIDENCE, Arterienklemmen	108
Gefäßdilatatoren	153, 294, 295	HRYNTSCHAK, Blasen-Wundspreizer	413
GEISSENDOERFER-OVERHOLT, Arterienklemmen	113	HRYNTSCHAK-YOUNG, Nadelhalter	213
GELLHORN, Uterus-Biopsiezangen	364	HUNT, Pinzetten	151
GELPI, selbsthaltende Wundsperrerr	276	HURD, Unterbindungsnadeln	227
GEMINI, Präparier- und Ligaturklemmen	121	Hysterektomieklemmen	127-131
GERALD, Pinzetten	144	Hysteroskopie	371
GILLIES, Hartmetallnadelhalter TUC	220	I	
GILLIES, Hartmetallpinzetten TUC	155	Instrumentarium zur Hysterosalpingographie	370
GILLIES, Nadelhalter	211	Instrumente für die Amnionblase	387
GILLIES, Pinzetten	149	Instrumente für Mini-Laparotomie	379
GIL-VERNET, feine Wundhaken	250	Instrumente für Prostata-Operationen	409
GOELET, Wundhaken	269	Instrumente zur Entfernung von Spiralen	378
GOLDMAN-FOX, Hartmetallscheren TUC	196	Instrumente, Mess-	325
Goniometer	325	Instrumentenablageplatten	423
GOODELL, Uterus-Dilatatoren	351	Instrumentenkästen	424
GORNEY, Präparierscheren	171	Inzisionsscheren	164
GOSSET, Bauchdeckenhalter	280	IOWA, Instrumente für die Amnionblase	387
GOURDET, Uteruslöffel	377	IOWA, Spezialkanülen	302
GRAVE SPECIAL, Scheidenspekula mit Absaugung	337	ISRAEL, Wundhaken	253
GRAVE, Scheidenspekula	334, 336	J	
GRAVE, Scheidenspekula mit Absaugung	336	JACKSON, Kaltlichtlaryngoskope	319
GRAY, Gallenkanalklemmen	126	JACOBI, Unterbindungsnadeln	226
GRAZIL, Chirurgische Scheren	163	JACOBS, Hakenzangen	355
Grazile Arterienklemmen	112	JAMESON, Caliper	325
GREEN-ARMYTAGE, Plazentar- und Abortuszangen	384	JAMESON, Nadelhalter	210
GREEN-SENN, feine Wundhaken	248	JANET, Spritzen	304
GROSS-MAIER, Kornzangen	239, 240	JEWELER, Hartmetallpinzetten TUC	155
GUYON, Dilatationsbesteck	416	JOBSON-HORNE, Watteträger	293
GUYON, Dilatationsbougies	417	JOHNS HOPKINS, Präparier- und Ligaturklemmen	118
GUYON, Katheter-Einführinstrumente	414	JONES, Tuchklemmen	133
GUYON, Nierenstielklemmen	124, 125	JOSEPH, Präparierscheren	172
GUYON-ARTRAUMATIC, Nierenstielklemmen	125	JUDD-MASSON, Blasen-Wundspreizer	412
Gynäkologische Scheren	165-167, 189-191	K	
H		Kaltlichtlaryngoskope	313-316
HABERER, Bauchspatel	287	Kaltlichtträger	319
Hähne	305	KANE, Nabelschnurklemmen	388
Haken, Wund-	246-269	KANTER-HEANEY, Hysterektomieklemmen	129
Hakenzangen	354, 355	KANTROWITZ, Präparier- und Ligaturklemmen	121
HALSTED, Arterienklemmen	108	Kanülen, Spezial-	302
HALSTED-MOSQUITO, Arterienklemmen	107	Katheter-Einführungsinstrumente	414
Halter, Bauchdecken-	280-286	Katheterzangen	317
HANK, Uterus-Dilatatoren	349	KAYE, Face-Lift-Scheren TUC	196
HARRINGTON-MAYO, Scheren	165	KELLY, Arterienklemmen	109
HARTMANN, Arterienklemme	106	KELLY, Fistelscheren	166
Hartmetalleinsatzplättchen mit Pyramidenprofil	214, 215	KELLY, Schwammzangen	243
HEANEY, Hysterektomieklemmen	129	KELLY-RANKIN, Arterienklemmen	109
HEANEY, Nadelhalter	210	KELLY-RICHARDSON, Wundhaken	260
HEANEY, Wundhaken	267	KEVORKIAN, Saug- und Biopsieküretten	360
HEANEY-BALLANTINE, Hysterektomieklemmen	129	KEVORKIAN, Uterus-Biopsiezangen	367, 369
HEANEY-KANTER, Hysterektomieklemmen	129	KEVORKIAN-PACIFIC, Uterus-Biopsiezangen	362
HEANEY-REZAK, Hysterektomieklemmen	130	KIELLAND, Geburtszangen	383
HEATH, Ligaturscheren	178		
HEGAR, Uterus-Dilatatoren	346-348		

	Seite		Seite
KIELLAND-LUIKART, Geburtszangen	383	LOTH-SCHOEMAKER, Ligaturscheren	177
KILNER-RAGNELL, Präparierscheren	172	LOWER, Gallenkanalklemmen	123
KIRSCHNER, Führungshohlsonden	231	LUER-KOERTE, Gallensteinlöffel	407
KIRSCHNER-FERROZELL, Führungshohlsonden	231		
Klemmen	106-135	M	
Klemmen, Arterien-	106-113, 115, 116	MAGILL, Katheterzangen	317
Klemmen, Gallenkanal-	123, 126	MAGINOT, Hysterektomieklemmen	130
Klemmen, Hysterektomie-	127-131	Mammoplastik	389-397
Klemmen, Ligatur- und Präparier-	113-115, 117-122, 127	MARBACH, Episiotomiescheren	173
Klemmen, Nierenstiel-	123-125	MARKHAM-MEYERDING, selbsthaltende Wundsperrer	276
Klemmen, Parametrium-	132	MARTIN, Beckenzirkel	382
Klemmen, Präparier- und Ligatur-	113-115, 117-122, 127	MARTIN, Uterussonden	352
Klemmen, Schlauch-	135	MARTIN, Wundhaken	258
Klemmen, Tonsillen-	116	MASSE-ROBIN, Bauchdeckenhalter	285
Klemmen, Tuch-	133, 135	MASSON, Hartmetallnadelhalter TUC	219
KLINIKUM BERLIN, Schlauchklemme	135	MASSON, Nadelhalter	210
KNIGHTON, selbsthaltende Wundsperrer	279	MATHIEU, Einführungsinstrument	414
Knüpfpinzetten mit Plateau	152, 153	MATHIEU, Hartmetallnadelhalter TUC	221
KNUTSON, Beschneidungsinstrumente	415	MATHIEU, Nadelhalter	212
KOCHER, Blasenspatel	413	MATHIEU, Wundhaken	268
KOCHER, Führungshohlsonden	231	MATHIEU-DELICATE, Hartmetallnadelhalter TUC	221
KOCHER, Unterbindungsnadeln	225	MATHIEU-DELICATE, Nadelhalter	212
KOCHER, Wundhaken	251, 256, 262	MATHIEU-RYDER, Hartmetallnadelhalter TUC	222
KOCHER-DELICATE, Arterienklemmen	112	MATHIEU-RYDER-VASCULAR, Hartmetallnadelhalter TUC	222
KOCHER-LANGENBECK, Wundhaken	255	MAYO, Hartmetallscheren TUC	189
KOCHER-OCHSNER, Arterienklemmen	111	MAYO, Scheren	165
KOERTE, Wundhaken	252, 265	MAYO-ADAMS, selbsthaltende Wundsperrer	278
KOGAN, Endospekula	345	MAYO-BLAKE, Gallensteinzangen	406
KÖNIG, Führungshohlsonden	230	MAYO-HARRINGTON, Scheren	165
Kornzangen	238-244	MAYO-HEGAR, Hartmetallnadelhalter TUC	216
Kranioklast	386	MAYO-HEGAR, Nadelhalter	210
KRISTELLER, Scheidenspekula	340	MAYO-HEGAR-DELICATE, Hartmetallnadelhalter TUC	216
KRONECKER, Unterbindungsnadeln	227	MAYO-HEGAR-DELICATE, Nadelhalter	210
Küretten	360, 361, 373-376	MAYO-NOBLE, Scheren	165
		MAYO-RUSS., Fasspinzetten	148
L		MAYO-STILLE, Hartmetallscheren TUC	190
LAHEY, Gallenkanalklemmen	123	MAYO-STILLE, Scheren	165
LAHEY, Wundhaken	259	MC INDOE, Pinzetten	142
Lampen, Stirn-	324	MC INTOSH FIBRE OPTIC, Laryngoskope	313
LANDAU, Scheidenhalter	343	MC INTOSH, Laryngoskope	309
LANDAU-SEGOND, Hysterektomieklemmen	131	McCULLUM-DINGMAN, Brustdissektoren	396
LANDOLT, feine Scheren	176	McKISSOCK, Areola Markierer	397
LANE, chirurgische Pinzetten	143	McLEAN, Geburtszangen	383
LANE, Tuchklemmen	133	MEEKER, Präparier- und Ligaturklemmen	115
LANGENBECK, Wundhaken	254	Messapparate, Blutdruck-	328, 329
LANGENBECK-KOCHER, Wundhaken	255	Messbecher	421
LANGENBECK-MINI, feine Wundhaken	248	Messer, Abszess-	207
LANGENBECK-PARKER, Wundhaken	268	Messer, Fistel-	207
Laryngoskope	309-316	Messinstrumente	325
Laryngoskope, Kaltlicht-	313-316	Metall-Katheter	418
LAWRENCE, Präparier- und Ligaturklemmen	120	METZENBAUM, Hartmetallnadelhalter TUC	221
LEGUEU, Blasenspatel	413	METZENBAUM, Hartmetallscheren TUC	191, 192
LEGUEU, Blasen-Wundspreizer	411	METZENBAUM, Präparierscheren	168
LERICHE, Arterienklemmen	108	METZENBAUM-BABY, Präparierscheren	168
LEWKOWITZ, Abortuszangen	384	METZENBAUM-DELICATE, Hartmetallscheren TUC	193-195
LEXER, Hartmetallscheren TUC	193	METZENBAUM-DELICATE, Präparierscheren	170
LEXER, Präparierscheren	171	METZENBAUM-NELSON, Präparierscheren	169
LEXER-BABY, Präparierscheren	171	MEYERDING, feine Wundhaken	248
Ligatur- und Präparierklemmen	113-115, 117-122, 127	MEYERDING, selbsthaltende Wundsperrer	276
Ligaturscheren	177, 178	MEYERDING-MARKHAM, selbsthaltende Wundsperrer	276
Lineale	325	MICRO-ADSON, Pinzetten	141
LISTER, Hartmetallscheren TUC	197	MICRO-MOSQUITO, Arterienklemmen	107
LITTAUER, Ligaturscheren	177	MICRO-RYDER, Hartmetallnadelhalter TUC	217
LITTLE, Wundhaken	259	MICROVASCULAR, Hartmetallnadelhalter TUC	217
LITTLER, feine Scheren	175	MICRO-WULLSTEIN, Saugrohre	301
LOCKHART-MUMMERY, Sonden	292	MIDDELDORPF, Wundhaken	260
LONG, Hysterektomieklemmen	130	Mikronadelhalter	223
LORNA, Tuchklemme	134	Mikronadelhalter mit Rundgriff	223

	Seite		Seite
Mikropinzetten	152, 153	NOVAK, Saug- und Biopsieküretten	360
Mikroscheren	179-185	NOVAK-SCHOECKAERT, Saug- und Biopsieküretten	360
Mikroscheren, Adventitia	181, 183		
Mikroscheren, Dissection	181, 183	O	
Mikroscheren, Nerve	183		
MILAN, Biopsieküretten	361	O'BRIAN, feine Scheren	176
MILLER FIBRE OPTIC, Laryngoskope	315	OCHSNER-KOCHER, Arterienklemmen	111
MILLER, Laryngoskope	311	OEHLER, Hartmetallpinzetten TUC	155
MILLIGAN, selbsthaltende Wundsperrerr	270	OLLIER, Wundhaken	253
MILLIN, Blasen-Wundspreizer	411, 412	OLSEN-HEGAR, Hartmetallnadelhalter TUC	220
MILLIN, Instrumente für Prostata-Operationen	409	OLSEN-HEGAR, Nadelhalter	211
MILLIN-YOUNG, Nadelhalter	213	Operations-Skalpelle	204-206
MINI-LANGENBECK, feine Wundhaken	248	O'SULLIVAN-O'CONNOR, Wundspreizer	344
MINI-TOWNSEND, Uterus-Biopsiezangen	369	OTIS, Urethrotome	410
MISKIMON, selbsthaltende Wundsperrerr	271	OVERHOLT, Präparier- und Ligaturklemmen	114
MIXTER, Chirurgische Scheren	164	OVERHOLT-BABY, Präparier- und Ligaturklemme	113
MIXTER, Gallensteinzangen	406	OVERHOLT-GEISSENDOERFER, Präparier- und Ligaturklemmen	113
MIXTER, Präparier- und Ligaturklemmen	119, 120		
MIXTER-BABY, Präparier- und Ligaturklemmen	119	P	
MIXTER-O'SHAUGNESSY, Präparier- und Ligaturklemmen	119		
MOD. USA, Nabelschnurscheren	173	PARAMETRIUM, Hartmetallscheren TUC	190
MOD.BONN, feine Scheren	176	PARAMETRIUM, Parametriumklemmen	132
MOD.WIEN, Nahtinstrumente	232	Parametriumklemmen	132
MODELL TÜBINGEN, Wundhaken	258	PARKER, Wundhaken	268
MODELL USA, Pinzetten	141	PARKER-LANGENBECK, Wundhaken	268
MOELTGEN, Goniometer	325	PAYR, Führungshohlsonden	230
MOLDESTAD, feine Wundhaken	246	PAYR-SCHMIEDEN, Führungshohlsonden	230
MOLLISON, selbsthaltende Wundsperrerr	271	PEAN-DELICATE, Arterienklemmen	112
MORGEN, Beschneidungsinstrument	415	PEAN-ROCHESTER, Arterienklemmen	110
MORRIS, Retraktoren	257	PEDERSON, Scheidenspekula	334, 338
MOSQUITO-HALSTED, Arterienklemmen	107	PEDERSON, Scheidenspekula mit Absaugung	338
MOSQUITO-MICRO, Arterienklemmen	107	PEERS, Tuchklemmen	134
MOYNIHAN, Gallensteinsonden	405	PELKMANN, Tupferzangen	243
MOYNIHAN, Hysterektomieklammen	130	Penisklemmen	415
MUMMERY-LOCKHART, Sonden	292	Perforatorien	385
MUSEUX, Hakenzangen	355	PHANEUF, Hysterektomieklammen	131
Myom-Instrumente	357	PINARD, Stethoskope	326
MYRTLE-LEAF, Sonden	291	Pinzetten	139-157
		Pinzetten, anatomisch	139-147
N		Pinzetten, chirurgisch	139-147, 149, 150
		Pinzetten, Fass-	148-151
Nabelschnurenklemmen	388	Pinzetten, Hartmetall TUC	155-157
Nabelschnurscheren	173	Pinzetten, Knüpf- mit Plateau	152, 153
Nadelhalter	210-223	Pinzetten, Mikro-	152, 153
Nadelhalter, Boomerang-	213	PIPER, Geburtszangen	383
Nadelhalter, Hartmetall TUC-	216-222	Plazentar- und Abortuszangen	384
Nadelhalter, Mikro-	223	PLESTER, Saugrohre	301
Nadeln, Führungs-	303	PLESTER, selbsthaltende Wundsperrerr	277
Nadeln, Unterbindungs-	224-228	POOLE, Saugrohre	299
Nadel-Sterilisierkästen	422	POOLE-BABY, Saugrohre	299
NAEGELE, Geburtszangen	382	POTTS-SMITH, Hartmetallpinzetten TUC	155
NAEGELE, Perforatorien	385	POTTS-SMITH, Pinzetten	145
NAGER, Unterbindungsnadeln	228	POZZI, Hakenzangen	354
Naht	210-232	Präparier- und Ligaturklemmen	113-115, 117-122, 127
Narkose	308-319	Präparierscheren	168-172, 191-195
NEGUS, Gallenkanalklemmen	126	PRATT, Fistelsonden	292
NELATON, Sonden	291	PRATT, Hakenzangen	355
NELSON, Fasspinzetten	148	PRATT, Uterus-Dilatatoren	350
NELSON-METZENBAUM, Präparierscheren	169	PRECISA, Blutdruckmessapparate	329
NERVE, Mikroscheren	183	PRESBYTERIAN, Schlauchklemmen	135
Nerv-Präparierscheren	171	Prostatahaken	408
NEW PORT, Scheidenspekula	343	PROVIDENCE-HOSPITAL, Arterienklemmen	108
Nierenfasszange	403	Punktion/Kanülen	298-305
Nierenschalen	421	PYNCHON-ANDREWS, Saugrohre	298
Nierensteinzangen	401		
Nierenstielklemmen	123-125	R	
NOBLE-MAYO, Scheren	165		
NORTHBENT, Ligaturscheren	178	RAGNELL-KILNER, Präparierscheren	172
NOTO, Schwammzangen	242	RAMATHIBODI, Tuben-Haken	379

	Seite		Seite
RAMATHIBODI, Uterus-Manipulator	379	SCHRÖDER/SIMON, Uteruslöffel	377
RANDALL, Nierensteinzangen	401	SCHROEDER, Hakenzangen	354, 355
RANDALL, Saug- und Biopsieküretten	360	SCHUBERT, Uterus-Biopsiezangen	364, 365
RANKIN-CRILE, Arterienklemmen	109	SCHUHKNECHT, selbsthaltende Wundsperrerr	271
RANKIN-KELLY, Arterienklemmen	109	SCHULTZE, Hysterosalpingographie-Instrumentarium	370
RECAMIER/SIMS, Uterusküretten	373, 374	SCHUMACHER, Nabelschnurscheren	173
Reinigungspistole	453, 454	SCHUMACHER, Uterus-Biopsiezangen	367
Retraktoren, Brust	390-393	SCHUMACHER-VAN DOREN, Uterus-Biopsiezangen	366
REVERDIN, Bauchspatel	287	Schwammzangen	238-244
REYNOLDS, Präparierscheren	172	SEGOND, Hysterektomieklemmen	131
REZAK-HEANEY, Hysterektomieklemmen	130	SEGOND, Myom-Instrumente	357
RICARD, Bauchdeckenhalter	285	SEGOND-LANDAU, Hysterektomieklemmen	131
RICHARDSON-EASTMAN, Wundhaken	260	Selbsthaltende Wundsperrerr	270-279
RICHARDSON-KELLY, Wundhaken	260	SEMKEN, Hartmetallpinzetten TUC	155
RICHTER, Chirurgische Scheren	164	SEMKEN, Pinzetten	142, 143
RIGHBY, selbsthaltende Wundsperrerr	277	SEMM, Scheidenspekula	335
Ring-Applikator	372	SENN-GREEN, feine Wundhaken	248
RIRAP, Stethoskop	327	SEYFFERT, Scheidenspekula	335
ROBIN-MASSÉ, Bauchdeckenhalter	285	SHORTBENT, Ligaturscheren	178
ROCHESTER-PEAN, Arterienklemmen	110	SIEBOLD, Gynäkologische Scheren	167
ROEDER, Tuchklemmen	134	SIMON, Fistelhaken	359
ROTTER, Unterbindungsnadeln	228	SIMON, Fistelmesser	207
ROUX, Wundhaken	267	SIMON, Wundhaken	258
RUMEL, Präparier- und Ligaturklemmen	117	SIMON/SCHRÖDER, Uteruslöffel	377
Runde Schalen	421	SIMPSON, Geburtszangen	382
RUSS.-MAYO, Fasspinzetten	148	SIMPSON-BRAUN, Geburtszangen	382
RUSS.MODELL, Fasspinzetten	150	SIMS, Gynäkologische Scheren	167
RYDER-FRENCH-EYE, Hartmetallnadelhalter TUC	217	SIMS, Hartmetallscheren TUC	191
RYDER-MATHIEU VASCULAR, Hartmetallnadelhalter TUC	222	SIMS, Scheidenspekula	339
RYDER-MATHIEU, Hartmetallnadelhalter TUC	222	SIMS, Uterusdepressoren	353
RYDER-MICRO, Hartmetallnadelhalter TUC	217	SIMS, Uterus-Dilatatoren	351
		SIMS, Uterussonden	352
S		SIMS/RECAMIER, Uterusküretten	373, 374
		SIMS-SPECIAL, Uterussonden	352
SAENGER, Plazentar- und Abortuszangen	384	SINGLEY-TUTTLE, Fasspinzetten	148
SAIRGES, Hakenzangen	354	Skalpelle	201-208
SAMII, Pinzetten	151	Skalpellgriffe	201, 202
SANVENERO, Präparierscheren	172	Skalpellklingen	203
SAROT, Hartmetallnadelhalter TUC	219	SKENE, Hakenzangen	354
SAUERBRUCH, Wundhaken	256, 266	SMELLIE, Dekapitationshaken	385
Saug- und Biopsieküretten	360	SMELLIE, Perforatorien	385
Saugrohre	298-301	SMITH-FERRIS, Pinzetten	147
SAUNDERS, Instrument zur Entfernung von Spiralen	378	SMITH-POTTS, Hartmetallpinzetten TUC	155
SAWTELL-SCHNIDT, Tonsillenklemmen	116	SMITH-POTTS, Pinzetten	145
SCALP-CONTOUR, selbsthaltende Wundsperrerr	276	SOMER, Uterus-Fasszangen	358
SCHAEDEL, Tuchklemmen	133	Sonden	291, 292
Schalen	421, 423, 424	Sonden, Führungshohl-	229-231
Scheidenhalter	343	Sonden, Uterus-	352
Scheidenspekula	333-343	Spatel, Bauch-	287
Scheidenspekula mit Absaugung	336-338	SPENCER, Ligaturscheren	177
SCHERBACK, Scheidenspekula	342	SPENCER-DELICATE, Ligaturscheren	177
Scheren	161-197	SPENCER-WELLS, Arterienklemmen	106
Scheren, Bauchdecken-	166	Spiegel, Stirn-	323
Scheren, Chirurgische-	162-165, 174	Spritzen	304
Scheren, Episiotomie-	173	Spülschalen	424
Scheren, fein	174-176	STACKE, Sonden	291
Scheren, Gynäkologisch	165-167, 189-191	STADLER-BRAUN, Episiotomiescheren	173
Scheren, Hartmetall TUC	187-197	STANDARD, anatomische Pinzetten	139
Scheren, Ligatur-	177, 178	STANDARD, chirurgische Pinzetten	139
Scheren, Mikro-	179-185	STANDARD, Chirurgische Scheren	162
Scheren, Nabelschnur	173	STANDARD, Hartmetallscheren TUC	188, 189
Scheren, Präparier-	168-172, 191-195	Standgefäße	424
Scheren, Supercut SC	161	Stechbecken	425
Schlauchklemmen	135	Stethoskope	326, 327
SCHMID, Spezialkanülen	302	STEVENS, Hartmetallschere TUC	196
SCHMIEDEN, Unterbindungsnadeln	226	STILLE, Nierenstielklemmen	124
SCHMIEDEN-PAYR, Führungshohlsonden	230	STILLE, Pinzetten	147
SCHNIDT-SAWTELL, Tonsillenklemmen	116	STILLE-BARRAYA, Pinzetten	147
SCHOEMAKER-LOTH, Ligaturscheren	177	STILLE-DOYEN, Wundhaken	262

	Seite		Seite
STILLE-MAYO, Hartmetallscheren TUC	190	WISE, Knüpfpinzetten mit Plateau	152
STILLE-MAYO, Scheren	165	VOLKMANN, Wundhaken	251, 252
Stirnlampen	324	Vulvaspreizer	344
Stirnspiegel	323		
STOCKMANN, Penisklemmen	415	W	
STRATTE, Nadelhalter	211	WAGNER, feine Scheren	174
STRAUSS, Penisklemmen	415	WALDMANN, Episiotomiescheren	173
SULLIVAN (BROPHY), feine Scheren	175	WALLICH, Abortuslöffel	384
Super Cut Scheren	161	WALTON, feine Scheren	176
SYME, Unterbindungsnadeln	225	WALTON, selbsthaltende Wundsperrer	279
		WALTON-YANKAUER, Saugrohre	298
T		WANGENSTEEN, Hartmetallpinzetten TUC	157
Tablett	423	WANGENSTEEN, Nadelhalter	211
Tangentialklemmen	404	WANGENSTEEN, Pinzetten	147
TARNIER, Basiotrib	386	WANGENSTEEN-DELICATE, Nadelhalter	211
TAYLOR, Pinzetten	143	Watteträger	292, 293
TAYLOR-CUSHING, Hartmetallpinzetten TUC	156	WAUGH, Fasspinzette	149
TEALE, Hakenzangen	356	Weissbarth, Scheidenspekula	344
TEBBETS, Brustretractor	390, 402	WELLS-SPENCER, Arterienklemmen	106
TERRIER, Arterienklemme	106	WERTHEIM, Hartmetallnadelhalter TUC	220
THOMS-GAYLOR, Uterus-Biopsiezangen	365	WERTHEIM, Hysterektomieklappen	127, 128
THOREK, Präparierscheren	171	WERTHEIM, Hysterektomieklappen	127, 128
THORPE, Schieblehre	325	WERTHEIM, Nadelhalter	211
TISCHLER, Uterus-Biopsiezangen	363, 365, 369	WERTHEIM, Scheren	166
TISCHLER-KEVORKIAN, Uterus-Biopsiezangen	362	WERTHEIM-CULLEN, Hysterektomieklappen	131
TISCHLER-MORGAN, Uterus-Biopsiezangen	363	WESTERMARK, Tupferzangen	240
TOENNIS, Präparier- und Ligaturklemmen	122	WIKSTROEM, Präparier- und Ligaturklemmen	127
TOENNIS-ADSON-DELICATE, Hartmetallscheren TUC	196	WILSON, Hakenzange	354
TOHOKU-JAPAN, Tuchklemmen	134	WINTER, Plazentar- und Abortuszangen	384
Tonsillenklemmen	116	WITTNER, Uterus-Biopsiezangen	368
TRAVERS, selbsthaltende Wundsperrer	270	WRIGLEY, Geburtszangen	383
TRELAT, Unterbindungsnadeln	227	WULLSTEIN MICRO, Saugrohre	301
Tuben-Haken	379	WULLSTEIN, selbsthaltende Wundsperrer	271
TÜBINGEN MODELL, Wundhaken	258	Wundhaken	246-269
TÜBINGER MODELL, selbsthaltende Wundsperrer	278	Wundhaken, fein	246-250
Tuchklemmen	133, 134	Wundsperrer, selbsthaltend	270-279
TUFFIER, Bauchspatel	287	Wundspreizer	344
Tupferzangen	238-244		
TUTTLE-SINGLEY, Fasspinzetten	148	Y	
		YANKAUER, Saugrohre	298
U		YANKAUER-WALTON, Saugrohre	298
UCKERMANN, Watteträger	293	YOUNG, Prostatahaken	408
ULRICH, Kornzangen	238	YOUNG-HRYNTSCHAK, Nadelhalter	213
UNIVERSAL, Hartmetallscheren TUC	197	YOUNG-MILLIN, Nadelhalter	213
Unterbindungsnadeln	224-228		
Urethrotome	410	Z	
Urinale	425	Zangen, Korn-	238-244
URO-TANGENTIAL, Tangentialklemmen	404	Zangen, Schwamm-	238-244
Uterus-Biopsiezangen	362-369	Zangen, Tupfer-	238-244
Uterusdepressoren	353	ZENKER, Präparier- und Ligaturklemmen	118
Uterus-Dilatatoren	346-351		
Uterus-Fasszangen	357		
Uterusküretten	373-376		
Uteruslöffel	377		
Uterus-Manipulator	379		
Uterussonden	352		
V			
VALLEIX, Uterussonden	352		
VAN BUREN, Dilatationsbougies	417		
VAN DOREN, Uterus-Biopsiezangen	366		
Vasektomieklappen	400		
Verbindungsstücke	305		
VERNET-GIL, feine Wundhaken	250		
VERNIER, Caliper	325		
VERRES, Spezialkanülen	302		

Index

	Page		Page
A			
Abdominal, retractors	280-286	BECKMANN-EATON, selfretaining retractors	275
Abdominal, scissors	166	Bed pans	425
Abdominal, spatulas	287	BENGOLEA, artery forceps	116
Abscess knives	207	BERGER, cervical biopsy forceps	368
ACKERMANN, areola markers	397	BERNHARD, towel forceps	133
ADAMS-MAYO, selfretaining retractors	278	BILLROTH, retractors	252
ADLERKREUTZ, tissue forceps	147	Biopsy and aspirating curettes	361
ADSON, dissecting and ligature forceps	115	Biopsy forceps cervical	362-369
ADSON, dissecting forceps tungsten TUC	156	Biopsy suction curettes	360
ADSON, dressing forceps	141, 142	BIRKETT, dissecting and ligature forceps	127
ADSON, selfretaining retractors	272, 273	Bladder retractors	411-413
ADSON, suction tubes	301	BLAKE, gall stone forceps	406
ADSON-ANDERSON, selfretaining retractors	272	BLAKE, uterine curettes	376
ADSON-BABY, dissecting and ligature forceps	115	Blood pressure manometers	328, 329
ADSON-BABY, selfretaining retractors	274	BONNEY, dissecting forceps tungsten TUC	157
ADSON-BECKMANN, selfretaining retractors	275	BONNEY, grasping forceps	150
ADSON-BROWN, tissue forceps	142	Boomerang needle holders	213
ADSON-MICRO, dressing and tissue forceps	141	Bowls	421, 423, 424
ADSON-TOENNIS-DELICATE, scissors tungsten TUC	196	BOZEMANN, dressing forceps	241
Adventitia, micro scissors	181, 183	BOZEMANN, ligature instruments	232
AGRIS-DINGMAN, breast dissectors	396	BOZEMANN-DOUGLAS, dressing forceps	241
ALEXANDER, cervical biopsy forceps	367	BRAUN, cranioclast	386
Anaesthesia	308-319	BRAUN, decapitating hooks	385
ANDERSON-ADSON, selfretaining retractors	272	BRAUN, tenaculum forceps	354
ANDREWS-PYNCHON, suction tubes	298	BRAUN, uterine depressors	353
Areola markers	397	BRAUN-STADLER, episiotomy scissors	173
Artery forceps	106-113, 115, 116	Breast dissectors	394-396
Artery forceps, delicate	112	BREISKY, vaginal retractors	343
Aspirating and biopsy curettes	361	BRIDGE, dissecting and ligature forceps	120
AUSTIN, tying forceps	152	BRODIE, probes	292
AUVARD, vaginal specula	342	BROPHY (SULLIVAN), fine scissors	175
AYRE, myoma instruments	357	BROPHY, dressing and tissue forceps	145
AYRE, Myoma Knife	208	BROWN, tissue forceps	146
B			
BABY-ADSON, ligature and dissecting forceps	115	BROWN-ADSON, tissue forceps	142
BABY-ADSON, selfretaining retractors	274	BRUNNER, ligature conductors	229
BABY-BALFOUR, abdominal retractors	281	BRUNNER, ligature needles	225, 226
BABY-COLLIN, abdominal retractors	283	BRUNNER, retractors	259
BABY-CRILE-WOOD, needle holders tungsten TUC	218	BRUNNER-FERROZELL, ligature conductors	231
BABY-LEXER, scissors	171	BUCK, ligature scissors	178
BABY-LIGHTWEIGHT-DUPLEX, stethoscopes	327	BUMM, uterine curettes	375
BABY-METZENBAUM, scissors	168	BURKE, cervical biopsy forceps	362
BABY-MIXTER, dissecting and ligature forceps	119	BUSCH, umbilical scissors	173
BABY-OVERHOLT, dissecting and ligature forceps	113	BYRD, suction tubes	299
BABY-POOLE, suction tubes	299	C	
BABY-TISCHLER, cervical biopsy forceps	363	CAIRNS, artery forceps	112
BACKHAUS, towel forceps	134	Caliper	325
BAKES, gall duct dilators	405	CANNY RYALL, retractors	269
BALFOUR US-TYPE, abdominal retractors	281	CARDINALE, scissors	167
BALFOUR, abdominal retractors	281, 282	CARDINALE, scissors tungsten TUC	191
BALFOUR-BABY, abdominal retractors	281	CARDIOPHON, stethoscope	327
BALL & SOCKET, towel forceps	134	CAROLL, goniometers	325
BALLANTINE-HEANEY, hysterectomy forceps	129	CARREL, artery forceps	106
BALLENGER-FOERSTER, sponge holding forceps	244	Catheter forceps	317
BARRAYA-STILLE, tissue forceps	147	Catheter introducing instruments	414
BARRETT, tenaculum forceps	354	Cervical biopsy forceps	362-369
Basiotribe	386	Circumcision instruments	415
BAUMGARTNER, needle holders	210	Clamps, tubing	135
BEACHAM, instrument for the amnion bladder	387	CLAR 55, head lamps	324
BECKMANN, selfretaining retractors	274	CLAR STANDARD, head lamps	324
BECKMANN-ADSON, selfretaining retractors	275	CLAUS, ligature needles	227
		CLAUS-EICKEN, ligature needles	228
		COHEN, uterine sounds	372
		COLLER, artery forceps	109

	Page		Page
COLLIN, abdominal retractors	283, 284	Dissecting, ligature forceps	113-115, 117-122, 127
COLLIN, kidney elevating forceps	403	Dissecting, scissors	168-172, 191-195
COLLIN, operating knives	205	Dissection, micro scissors	181, 183
COLLIN, scalpel handles	202	DOUAY, cervical biopsy forceps	369
COLLIN, umbilical cord clamps	388	DOUGLAS-BOZEMANN, dressing forceps	241
COLLIN, uterine curettes	376	DOYEN, myoma instruments	357
COLLIN, vaginal specula	334	DOYEN, probes	291
COLLIN-BABY, abdominal retractors	283	DOYEN, scissors	166
COLLIN-DUVAL, grasping forceps	148	DOYEN, towel forceps	133
COLLIN-HARTMANN, retractors	267	DOYEN, vaginal specula	341
Conductors, ligature	229-231	DOYEN-STILLE, retractors	262
CONE KNIFE, Myoma Knife	208	Dressing forceps	139-147
CONE, selfretaining retractors	274	Dressing forceps	238-244
Connecting pieces	305	DUBOIS, scissors	167
Container systems	427-448	DUEHRSEN, dressing and tissue forceps	146
COOLEY, suction tubes	300	DUNHILL, artery forceps	112
COOLEY, vascular dilators	294	DUPLAY, tenaculum forceps	354
COOPER, ligature needles	225	DUPLEX-LIGHTWEIGHT/BABY, stethoscopes	327
CORYLLOS, retractors	266	DURANTE, grasping forceps	150
Cotton applicators	292, 293	DUVAL, grasping forceps	150
COUPLAND, suction tubes	299	DUVAL-COLLIN, grasping forceps	148
Cranioclast	386		
CRILE, artery forceps	109	E	
CRILE-RANKIN, artery forceps	109	EASTMAN-RICHARDSON, retractors	260
CRILE-WOOD, needle holders tungsten TUC	218	EATON-BECKMANN, selfretaining retractors	275
CRILE-WOOD-BABY, needle holders tungsten TUC	218	EICKEN-CLAUS, ligature needles	228
CULLEN-WERTHEIM, hysterectomy forceps	130	EICKEN-KILLIAN, suction tubes	301
Curettes	360, 361, 373-376	EISELSBERG, ligature scissors	177
CUSCO, vaginal specula	333, 338	EMMET, fistula hooks	359
CUSCO, vaginal specula with suction tube	338	Endoscopy, Pelviscopy	372
CUSCO-SUISSE, vaginal specula	333	Endospecula	345
CUSCO-VIRGIN, vaginal specula	333	ENGL.MODELL, towel forceps	133
CUSHING, delicate hooks	246	Episiotomy scissors	173
CUSHING, delicate retractors	249	EPPENDORF, cervical biopsy forceps	368, 369
CUSHING, dissecting forceps tungsten TUC	156	EUFRATE-PASQUE, microvascular needle holders TUC	217
CUSHING, dressing and tissue forceps	144	EWALD, dressing and tissue forceps	142
CUSHING-TAYLOR, dissecting forceps tungsten TUC	156		
CZERNY, retractors	269	F	
		Face-lift scissors TUC	196
D		FALK, ligature needles	228
DARLING, selfretaining retractors	277	FARABEUF, retractors	268
DARTIGUES, uterine elevating forceps	358	FARREL, cotton applicators	292
DE BAKEY (MAYO-HEGAR-DELICATE), needle holders TUC	216	FAURE, cervical biopsy forceps	364
DE BAKEY, dissecting forceps tungsten TUC	157	FAURE, hysterectomy forceps	131
DE BAKEY, non-traumatic tissue forceps	154	FEIN, cotton applicators	293
DE BAKEY, suction tubes	298	FERGUSSON, operating scissors	164
DE BAKEY, vascular dilators	295	FERGUSSON, suction tubes	301
DE LA ROZA, ligature needles	226	FERREIRA, mammoplasty retractors	391
DE LEE, obstetrical forceps	383	FERRIS-SMITH, tissue forceps	147
DEAVER, operating scissors	164	FERROZELL, ligature conductors	231
DEAVER, retractors	263-265	FERROZELL-BRUNNER, ligature conductors	231
Decapitating hooks	385	FERROZELL-KIRSCHNER, ligature conductors	231
Delicate artery forceps	112	Fibre optic laryngoscopes	313-316
Delicate hooks	246-250	FIBRE OPTIC, fibre optic laryngoscopes	316
DESCHAMPS, needles	224	Fibre optice carriers	319
DESJARDINS, gall duct forceps	126	Fine artery forceps	107
DESJARDINS, gall stone forceps	407	Fine scissors	176
DESJARDINS, gall stone probes	405	Fine scissors	174-176
DESJARDINS, gall stone scoops	406	FINOCCHIETTO, kidney pedicle clamp forceps	123
DESMARRES, delicate retractors	249	FINOCCHIETTO, needle holders	211
Diagnostics	321-329	Fistula hooks	359
DIEFFENBACH, abscess knives	207	Fistula knives	207
DIEFFENBACH, operating knives	206	Fistula scissors	166
Dilating bougies	417	FOERSTER-BALLENGER, sponge holding forceps	244
Dilating sounds, Set	416	FOMON, dissecting scissors	171
Dilators, uterine	346-351	Forceps	139-157
Dilators, vascular	294, 295	Forceps, artery	106-113, 115, 116
DIPLOMAT, blood pressure manometers	328		

	Page		Page
Forceps, catheter	317		
Forceps, dissecting and ligature	113-115, 117-122, 127	H	
Forceps, dressing	139-147		
Forceps, grasping	238-244	HABERER, abdominal spatulas	287
Forceps, hysterectomy	148-151	HALSTED, artery forceps	108
Forceps, kidney pedicle clamp	127-131	HALSTED-MOSQUITO, artery forceps	107
Forceps, non-traumatic vascular tissue	123-125	HANK, uterine dilators	349
Forceps, parametrium	154	HARTMANN, artery forceps	106
Forceps, polypus	132	Head lamps	324
Forceps, sponge holding	238-244	Head mirrors	323
Forceps, tissue	238-244	HEANEY, hysterectomy forceps	129
Forceps, tonsil hemostatic	139-147, 149, 150	HEANEY, needle holders	210
Forceps, towel	116	HEANEY, retractors	267
Forceps, tungsten TUC	133, 134	HEANEY-BALLANTINE, hysterectomy forceps	129
FOREGGER (WISCONSIN) FIBRE OPTIC, laryngoscopes	155-157	HEANEY-KANTER, hysterectomy forceps	129
FOREGGER (WISCONSIN), laryngoscopes	314	HEANEY-REZAK, hysterectomy forceps	130
FOX-GOLDMAN, scissors tungsten TUC	310	HEATH, ligature scissors	178
FRANKENFELDT, grasping forceps	196	HEGAR, uterine dilators	346-348
FRAZIER, suction tubes	296	HEGAR-MAYO, needle holders	210
FREEMAN, areola markers	301	HEGAR-MAYO, needle holders tungsten TUC	216
FREEMAN, mammaplasty retractor with fibre-optic illumination	397	HEGAR-MAYO-DELICATE (DE BAKEY), needle holders TUC	216
FRENCH-EYE/RYSER, needle holders tungsten TUC	402	HEGAR-MAYO-DELICATE, needle holders	210
FRIEDMANN, vulva retractors	217	HEGAR-OLSEN, needle holders	211
FRIEDRICH, ligature instruments	344	HEGAR-OLSEN, needle holders tungsten TUC	220
FRITSCH, retractors	232	HEIFETZ, grasping forceps	151
	262	Hemostats	106-135
G		HENLEY, selfretaining retractors	270
Gall duct dilators	405	HENROTIN, tenaculum forceps	356
Gall duct forceps	123, 126	HERRICK, kidney pedicle clamp forceps	125
Gall stone forceps	406	HESSBERG, ligature needles	226
Gall stone probes	405	HOESEL, retractors	261
Gall stone scoops	407	HOLINGER, laryngoscopes	318
GARLAND, hysterectomy forceps	130	Hooks, delicate	246-250
GARRETT, vascular dilators	294	HOPKINS-JOHNS, dissecting and ligature forceps	118
GEISSENDOERFER-OVERHOLT, dissecting and ligature forceps	113	HORNE-JOBSON, cotton applicators	293
GELLHORN, cervical biopsy forceps	364	HOSPITAL-PROVIDENCE, artery forceps	108
GELPI, selfretaining retractors	276	HRYNTSCHAK, bladder retractors	413
GEMINI, dissecting and ligature forceps	121	HRYNTSCHAK-YOUNG, boomerang needle holders	213
GERALD, dissecting and tissue forceps	144	HUNT, grasping forceps	151
GILLIES, dissecting forceps tungsten TUC	155	HURD, ligature needles	227
GILLIES, needle holders	211	Hysterectomy forceps	127-131
GILLIES, needle holders tungsten TUC	220	Hysteroscopy	371
GILLIES, tissue forceps	149	I	
GIL-VERNET, delicate retractors	250	Incision scissors	164
GOELET, retractors	269	Instrument boxes	424
GOLDMAN-FOX, scissors tungsten TUC	196	Instrument Storing Tray	423
Goniometers	325	Instrumentation for hystero-salpingography	370
GOODELL, uterine dilators	351	Instrumentation for hysteroscopy	371
GORNEY, dissecting scissors	171	Instruments for mini-laparotomy	379
GOSSET, abdominal retractors	280	Instruments for removal of I.U.D.	378
GOURDET, uterine scoops	377	Instruments for the amnion bladder	387
Graduated Measures	421	Introducing forceps	414
Grasping forceps	148-151	IOWA, instruments for the amnion bladder	387
GRAVE SPECIAL, vaginal specula with suction tube	337	IOWA, special needles	302
GRAVE, vaginal specula	334, 336	ISRAEL, retractors	253
GRAVE, vaginal specula with suction tube	336		
GRAY, gall duct forceps	126	J	
GRAZIL, operating scissors	163	JACKSON, fibre optic laryngoscopes	319
GREEN-ARMYTAGE, placenta and ovum forceps	384	JACOBI, ligature needles	226
GREEN-SENN, delicate retractors	248	JACOBS, tenaculum forceps	355
GROSS-MAIER, polypus forceps	239, 240	JAMESON, caliper	325
Guide needles	303	JAMESON, needle holders	210
GUYON, catheter introducing instruments	414	JANET, syringes	304
GUYON, dilating bougies	417	Jars	424
GUYON, kidney pedicle clamp forceps	124, 125	JEWELER, dissecting forceps tungsten TUC	155
GUYON, set of dilating sounds	416	JOBSON-HORNE, cotton applicators	293
Gynecological scissors	165-167, 189-191		

	Page		Page
JOHNS-HOPKINS, dissecting and ligature forceps	118	LEXER-BABY, scissors	171
JONES, towel forceps	133	Ligature and dissecting forceps	113-115, 117-122, 127
JOSEPH, dissecting scissors	172	Ligature Catcher	232
JUDD-MASSON, bladder retractors	412	Ligature conductors	229-231
K		Ligature scissors	177, 178
KANE, umbilical cord clamps	388	Ligature, instruments	232
KANTER-HEANEY, hysterectomy forceps	129	Ligature, needles	224-228
KANTROWITZ, dissecting and ligature forceps	121	LISTER, scissors tungsten TUC	197
KAYE, Face-lift scissors TUC	196	LITTAUER, ligature scissors	177
KELLY (RICHARDSON), retractors	260	LITTLE, retractors	259
KELLY, artery forceps	109	LITTLER, fine scissors	175
KELLY, scissors	166	LOCKHART-MUMMERY, probes	292
KELLY, sponge holding forceps	243	LONG, hysterectomy forceps	130
KELLY-RANKIN, artery forceps	109	Loop Twisters	232
KEVORKIAN, cervical biopsy forceps	367, 369	LORNA, towel forceps	134
KEVORKIAN, suction biopsy curettes	360	LOTH-SCHOEMAKER, ligature scissors	177
KEVORKIAN-PACIFIC, cervical biopsy forceps	362	LOWER, gall duct forceps	123
Kidney elevating forceps	403	LUER-KOERTE, gall stone scoops	407
Kidney pedicle clamp forceps	123-125	M	
Kidney stone forceps	401	MAGILL, catheter forceps	317
Kidney tray	421	Mammaplasty	389-397
KIELLAND, obstetrical forceps	383	Mammaplasty retractors	390-393
KIELLAND-LUIKART, obstetrical forceps	383	MARBACH, episiotomy scissors	173
KILNER (RAGNELL), scissors	172	MARKHAM-MEYERDING, selfretaining retractors	276
KIRSCHNER, ligature conductors	231	MARTIN, pelvimeters	382
KIRSCHNER-FERROZELL, ligature conductors	231	MARTIN, retractors	258
KLINIKUM BERLIN, tubing clamps	135	MARTIN, uterine sounds	352
KNIGHTON, selfretaining retractors	279	MASSE-ROBIN, abdominal retractors	285
Knives, abscess	207	MASSON, needle holders	210
Knives, fistula	207	MASSON, needle holders tungsten TUC	219
Knives, operating	204-206	MATHIEU, introducing forceps	414
Knot-Tiers	232	MATHIEU, needle holders	212
KNUTSON, circumcision instruments	415	MATHIEU, needle holders tungsten TUC	221
KOCHER, bladder retractors	413	MATHIEU, retractors	268
KOCHER, ligature conductors	231	MATHIEU-DELICATE, needle holders	212
KOCHER, ligature needles	225	MATHIEU-DELICATE, needle holders tungsten TUC	221
KOCHER, retractors	251, 256, 262	MATHIEU-RYDER VASCULAR, needle holders tungsten TUC	222
KOCHER-DELICATE, artery forceps	112	MATHIEU-RYDER, needle holders tungsten TUC	222
KOCHER-LANGENBECK, retractors	255	MAYO, scissors	165
KOCHER-OCHSNER, artery forceps	111	MAYO-ADAMS, selfretaining retractors	278
KOERTE, retractors	252, 265	MAYO-BLAKE, gall stone forceps	406
KOGAN, endospecula	345	MAYO-HARRINGTON, scissors	165
KÖNIG, ligature conductors	230	MAYO-HEGAR, needle holders	210
KRISTELLER, vaginal specula	340	MAYO-HEGAR, needle holders tungsten TUC	216
KRONECKER, ligature needles	227	MAYO-HEGAR-DELICATE (DE BAKEY), needle holders TUC	216
L		MAYO-HEGAR-DELICATE, needle holders	210
LAHEY, gall duct forceps	123	MAYO-NOBLE, scissors	165
LAHEY, retractors	259	MAYO-RUSS., grasping forceps	148
LANDAU, vaginal retractors	343	MAYO-STILLE, scissors	165
LANDAU-SEGOND, hysterectomy forceps	131	MAYO-STILLE, scissors tungsten TUC	190
LANDOLT, fine scissors	176	MC INDOE, dressing forceps	142
LANE, tissue forceps	143	MC INTOSH FIBRE OPTIC, laryngoscopes	313
LANE, towel forceps	133	MC INTOSH, laryngoscopes	309
LANGENBECK, retractors	254	McCOLLUM-DINGMAN, breast dissectors	396
LANGENBECK-KOCHER, retractors	255	McKISSOCK, areola markers	397
LANGENBECK-MINI, delicate retractors	248	McLEAN, obstetrical forceps	383
LANGENBECK-PARKER, retractors	268	Measuring instruments	325
Laryngoscopes	309-316	MEEKER, dissecting and ligature forceps	115
Laryngoscopes, fibre optic	313-316	Metal catheters	418
LAWRENCE, dissecting and ligature forceps	120	METZENBAUM, needle holders tungsten TUC	221
LEGUEU, bladder retractors	411, 413	METZENBAUM, scissors	168
LERICHE, artery forceps	108	METZENBAUM, scissors tungsten TUC	191, 192
LEWKOWITZ, ovum forceps	384	METZENBAUM-BABY, scissors	168
LEXER, scissors	171	METZENBAUM-DELICATE, scissors	170
LEXER, scissors tungsten TUC	193	METZENBAUM-DELICATE, scissors tungsten TUC	193-195
		METZENBAUM-NELSON, scissors	169
		MEYERDING, delicate retractors	248

	Page		Page
MEYERDING, selfretaining retractors	276	NOBLE-MAYO, scissors	165
MEYERDING-MARKHAM, selfretaining retractors	276	Non-traumatic vascular tissue forceps	154
Micro forceps	152, 153	NORTHBENT, ligature scissors	178
Micro needle holders	223	NOTO, sponge holding forceps	242
Micro needle holders with pen-type handle	223	NOVAK, suction biopsy curettes	360
Micro scissors	179-185	NOVAK-SCHOECKAERT, suction biopsy curettes	360
MICRO WULLSTEIN, suction tubes	301	O	
MICRO-ADSON, dressing and tissue forceps	141	O'BRIAN, fine scissors	176
MICRO-MOSQUITO, artery forceps	107	Obstetrical forceps	382, 383
MICRO-RYDER, needle holders tungsten TUC	217	OCHSNER-KOCHER, artery forceps	111
MICROVASCULAR, needle holders TUC	217	OEHLER, dissecting forceps tungsten TUC	155
MIDDLEDORPF, retractors	260	OLLIER, retractors	253
MILAN, biopsy curettes	361	OLSEN-HEGAR, needle holders	211
MILLER FIBRE OPTIC, laryngoscopes	315	OLSEN-HEGAR, needle holders tungsten TUC	220
MILLER, laryngoscopes	311	Operating knives	204-206
MILLIGAN, selfretaining retractors	270	Operating scissors	162-165, 174
MILLIN, bladder retractors	411, 412	O'SHAUGNESSY-MIXTER, dissecting and ligature forceps	119
MILLIN, prostatectomy instruments	409	O'SULLIVAN-O'CONNOR, retractors	344
MILLIN-YOUNG, boomerang needle holders	213	OTIS, urethrotomes	410
MINI-LANGENBECK, delicate retractors	248	OVERHOLT, dissecting and ligature forceps	114
MINI-TOWNSEND, cervical biopsy forceps	369	OVERHOLT-BABY, dissecting and ligature forceps	113
MISKIMON, selfretaining retractors	271	OVERHOLT-GEISSENDOERFER, dissecting and ligature forceps	113
Mixing bowls	421	Ovum and placenta forceps	384
MIXTER, dissecting and ligature forceps	119, 120	Ovum scoop	384
MIXTER, gall stone forceps	406	P	
MIXTER, operating scissors	164	PARAMETRIUM, parametrium forceps	132
MIXTER-BABY, dissecting and ligature forceps	119	PARAMETRIUM, scissors tungsten TUC	190
MIXTER-O'SHAUGNESSY, dissecting and ligature forceps	119	PARKER, retractors	268
MOD. BONN, fine scissors	176	PARKER-LANGENBECK, retractors	268
MOD.USA, dressing and tissue forceps	141	PAYR, ligature conductors	230
MOD.USA, umbilical scissors	173	PAYR-SCHMIEDEN, ligature conductors	230
MOD.WIEN, ligature instruments	232	PEAN-DELICATE, artery forceps	112
MODELL TÜBINGEN, retractors	258	PEAN-ROCHESTER, artery forceps	110
MOELTGEN, goniometers	325	PEDERSON, vaginal specula	334, 338
MOLDESTAD, delicate hooks	246	PEDERSON, vaginal specula with suction tube	338
MOLLISON, selfretaining retractors	271	PEERS, towel forceps	134
MORGEN, circumcision instruments	415	PELKMANN, dressing forceps	243
MORRIS, retractors	257	Pelvimeters	382
MOSQUITO-HALSTED, artery forceps	107	Penis seizing forceps	415
MOSQUITO-MICRO, artery forceps	107	Perforators	385
MOYNIHAN, gall stone probes	405	PHANEUF, hysterectomy forceps	131
MOYNIHAN, hysterectomy forceps	130	PINARD, stethoscopes	326
MUMMERY-LOCKHART, probes	292	PIPER, obstetrical forceps	383
MUSEUX, tenaculum forceps	354	Placenta and ovum forceps	384
Myoma instruments	358	PLESTER, selfretaining retractors	277
Myoma Knife	208	PLESTER, suction tubes	301
MYRTLE LEAF, probes	291	Polypus forceps	238-244
N		POOLE, suction tubes	299
NABATOFF, varicose vein probe set	293	POOLE-BABY, suction tubes	299
NAEGELE, obstetrical forceps	382	POTTS-SMITH, dissecting forceps tungsten TUC	155
NAEGELE, perforators	385	POTTS-SMITH, dressing and tissue forceps	145
NAGER, ligature needles	228	POZZI, tenaculum forceps	354
Needle holders	210-223	PRATT, fistula probe	292
Needle holders, boomerang	213	PRATT, tenaculum forceps	355
Needle holders, micro	223	PRATT, uterine dilators	350
Needle holders, tungsten TUC	216-222	PRECISA, blood pressure manometers	329
Needle Sterilizing Cases	422	PRESBYTERIAN, tubing clamps	135
Needles, Deschamps	224	Probes	291, 292
Needles, guide	303	Prostatectomy instruments	409
Needles, ligature	224-228	Prostatic retractors	408
NEGUS, gall duct forceps	126	PROVIDENCE-HOSPITAL, artery forceps	108
NELATON, probes	291	Puncture/Special Needles	298-305
NELSON, grasping forceps	148	PYNCHON-ANDREWS, suction tubes	298
NELSON-METZENBAUM, scissors	169	R	
Nerve dissecting scissors	171		
Nerve, micro scissors	183		
NEW PORT, vaginal specula	343		

	Page		Page
RAGNELL (KILNER), scissors	172	Scissors, dissecting	168-172, 191-195
RAMATHIBODI, tubal hook	379	Scissors, episiotomy	173
RAMATHIBODI, uterine manipulator	379	Scissors, fine	176
RANDALL, kidney stone forceps	401	Scissors, fine	174-176
RANDALL, suction biopsy curettes	360	Scissors, gynecological	165-167, 189-191
RANKIN-CRILE, artery forceps	109	Scissors, incision	164
RANKIN-KELLY, artery forceps	109	Scissors, ligature	177, 178
RECAMIER/SIMS, uterine curettes	373, 374	Scissors, micro	179-185
Retractors	344	Scissors, micro adventitia	181, 183
Retractors	246-269	Scissors, micro dissection	181, 183
Retractors	246-269	Scissors, micro nerve	183
Retractors, abdominal	280-286	Scissors, nerve dissecting	171
Retractors, self-retaining	270-279	Scissors, operating	162-165, 174
REVERDIN, abdominal spatulas	287	Scissors, super-cut SC	161
REYNOLDS, scissors	172	Scissors, tungsten TUC	187-197
REZAK-HEANEY, hysterectomy forceps	130	Scissors, umbilical	173
RICARD, abdominal retractors	285	SEGOND, hysterectomy forceps	131
RICHARDSON (KELLY), retractors	260	SEGOND, myoma instruments	357
RICHARDSON-EASTMAN, retractors	260	SEGOND-LANDAU, hysterectomy forceps	131
RICHTER, operating scissors	164	Self-retaining retractors	270-279
RIGHBY, selfretaining retractors	277	SEMKEN, dissecting forceps tungsten TUC	155
Ring applicator	372	SEMKEN, dressing and tissue forceps	142, 143
RIRAP, stethoscopes	327	SEMM, vaginal specula	335
ROBIN-MASSE, abdominal retractors	285	SENN-GREEN, delicate retractors	248
ROCHESTER-PEAN, artery forceps	110	Set of dilating sounds	416
ROEDER, towel forceps	134	SEYFFERT, vaginal specula	335
ROTTER, ligature needles	228	SHORTBENT, ligature scissors	178
ROUX, retractors	267	SIEBOLD, scissors	167
Rulers	325	SIMON, fistula hooks	359
RUMEL, dissecting and ligature forceps	117	SIMON, fistula knives	207
grasping forceps	148	SIMON, retractors	258
RUSS.MODELL, grasping forceps	150	SIMON/SCHRÖDER, uterine scoops	377
RYDER/FRENCH EYE, needle holders tungsten TUC	217	SIMPSON, obstetrical forceps	382
RYDER-MATHIEU VASCULAR, needle holders tungsten TUC	222	SIMPSON-BRAUN, obstetrical forceps	382
RYDER-MATHIEU, needle holders tungsten TUC	222	SIMS, scissors	167
RYDER-MICRO, needle holders tungsten TUC	217	SIMS, scissors tungsten TUC	191
S		SIMS, uterine depressors	353
SAENGER, placenta and ovum forceps	384	SIMS, uterine dilators	351
SAIRGES, tenaculum forceps	354	SIMS, uterine sounds	352
SAMII, grasping forceps	151	SIMS, vaginal specula	339
SANVENERO, scissors	172	SIMS/RECAMIER, uterine curettes	373, 374
SAROT, needle holders tungsten TUC	219	SIMS-SPECIAL, uterine sounds	352
SAUERBRUCH, retractors	256, 266	SINGLEY-TUTTLE, grasping forceps	148
SAUNDERS, instrument for removal of I.U.D.	378	SKENE, tenaculum forceps	354
SAWTELL-SCHNIDT, tonsil hemostatic forceps	116	SMELLIE, decapitating hooks	385
SCALP-CONTOUR, selfretaining retractors	276	SMELLIE, perforators	385
Scalpel blades	203	SMITH-FERRIS, tissue forceps	147
Scalpel, handles	201, 202	SMITH-POTTS, dissecting forceps tungsten TUC	155
Scalpels	201-208	SMITH-POTTS, dressing and tissue forceps	145
SCHAEDEL, towel forceps	133	Solutions bowls	424
SCHERBACK, vaginal specula	342	SOMER, uterine elevating forceps	358
SCHMID, special needles	302	Spatulas abdominal	287
SCHMIEDEN, ligature needles	226	Special needles	302
SCHMIEDEN-PAYR, ligature conductors	230	Special needles/puncture	298-305
SCHNIDT-SAWTELL, tonsil hemostatic forceps	116	SPENCER, ligature scissors	177
SCHOEMAKER-LOTH, ligature scissors	177	SPENCER-DELICATE, ligature scissors	177
SCHRÖDER/SIMON, uterine scoops	377	SPENCER-WELLS, artery forceps	106
SCHROEDER, tenaculum forceps	354, 355	Sponge holding forceps	238-244
SCHUBERT, cervical biopsy forceps	364, 365	Spray gun	453, 454
SCHUHKNECHT, selfretaining retractors	271	STACKE, probes	291
SCHULTZE, instrumentation for hystero-salpingography	370	STADLER-BRAUN, episiotomy scissors	173
SCHUMACHER, cervical biopsy forceps	367	STANDARD, dressing forceps	139
SCHUMACHER, umbilical scissors	173	STANDARD, operating scissors	162
SCHUMACHER-VAN DOREN, cervical biopsy forceps	366	STANDARD, scissors tungsten TUC	188, 189
Scissors	161-197	STANDARD, tissue forceps	139
Scissors, abdominal	166	Stethoscopes	326, 327
		STEVENS, scissors tungsten TUC	196
		STILLE, dressing and tissue forceps	147
		STILLE, kidney pedicle clamp forceps	124

	Page		Page
STILLE-BARRAYA, tissue forceps	147		
STILLE-DOYEN, retractors	262	Vaginal retractors	343
STILLE-MAYO, scissors	165	Vaginal specula	333, 343
STILLE-MAYO, scissors tungsten TUC	190	Vaginal specula with suction tube	336-338
STOCKMANN, penis seizing forceps	415	VALLEIX, uterine sounds	352
Stopcocks	305	VAN BUREN, dilating bougies	417
STRATTE, needle holders	211	VAN DOREN, cervical biopsy forceps	366
STRAUSS, penis seizing forceps	415	Varicose vein probe set	293
Suction biopsy curettes	360, 361	Vascular dilators	294
Suction tubes	298-305	Vascular, dilators	294, 295
SULLIVAN (BROPHY), fine scissors	175	Vasectomy Forceps	400
Super Cut Scissors	161	VERNET-GIL, delicate retractors	250
Suture	210-232	VERNIER, caliper	325
Suture tying forceps with platform	152, 153	VERRES, special needles	302
SYME, ligature needles	225	Vessel dilators	153
Syringes	304	WISE, suture tying forceps with platform	152
		VOLKMANN, retractors	251, 252
T		Vulva retractors	344
Tangential forceps	404	W	
TARNIER, basiotribe	386		
TAYLOR, dressing and tissue forceps	143	WAGNER, fine scissors	174
TAYLOR-CUSHING, dissecting forceps tungsten TUC	156	WALDMANN, episiotomy scissors	173
TEALE, tenaculum forceps	356	WALLICH, ovum scoop	384
TEBBETS, mammoplasty retractors	390, 402	WALTON, fine scissors	176
Tenaculum forceps	354, 355	WALTON, selfretaining retractors	279
TERRIER, artery forceps	106	WALTON-YANKAUER, suction tubes	298
THOMS-GAYLOR, cervical biopsy forceps	365	WANGENSTEEN, dissecting forceps tungsten TUC	157
THOREK, scissors	171	WANGENSTEEN, dressing forceps	147
THORPE, caliper	325	WANGENSTEEN, needle holders	211
TISCHLER, cervical biopsy forceps	363, 365, 369	WANGENSTEEN-DELICATE, delicate needle holders	211
TISCHLER-KEVORKIAN, cervical biopsy forceps	362	WAUGH, grasping forceps	149
TISCHLER-MORGAN, cervical biopsy forceps	363	WEISSBARTH, vaginal specula	344
Tissue forceps	139-147, 149, 150	WELLS-SPENCER, artery forceps	106
TOENNIS, dissecting and ligature forceps	122	WERTHEIM, hysterectomy forceps	127, 128
TOENNIS-ADSON-DELICATE, scissors tungsten TUC	196	WERTHEIM, needle holders	211
TOHOKU-JAPAN, towel forceps	134	WERTHEIM, needle holders tungsten TUC	220
Tonsil hemostatic forceps	116	WERTHEIM, scissors	166
Towel forceps	133, 134	WERTHEIM-CULLEN, hysterectomy forceps	131
TRAVERS, selfretaining retractors	270	WESTERMARK, dressing forceps	240
Tray	423	WIKSTROEM, dissecting and ligature forceps	127
TRELAT, ligature needles	227	WILSON, tenaculum forceps	354
Tubal hook	379	eps	384
Tubing clamps	135	WISCONSIN (FOEGGER) FIBRE OPTIC, laryngoscopes	314
TÜBINGEN MODELL, retractors	258	WISCONSIN (FOEGGER), laryngoscopes	310
TÜBINGER MODELL, selfretaining retractors	278	WITTNER, cervical biopsy forceps	368
TUFFIER, abdominal spatulas	287	WRIGLEY, obstetrical forceps	383
Tungsten Carbide Tips with pyramidal profile	214, 215	WULLSTEIN MICRO, suction tubes	301
TUTTLE-SINGLEY, grasping forceps	148	WULLSTEIN, selfretaining retractors	271
U		Y	
UCKERMANN, cotton applicators	293	YANKAUER, suction tubes	298
ULRICH, polypus forceps	238	YANKAUER-WALTON, suction tubes	298
Umbilical cord clamps	388	YOUNG, prostatic retractors	408
Umbilical scissors	173	YOUNG-HRYNTSCHAK, boomerang needle holders	213
Universal tray	423	YOUNG-MILLIN, boomerang needle holders	213
UNIVERSAL, scissors tungsten TUC	197		
Urethrotomes	410	Z	
URO-TANGENTIAL, tangential forceps	404		
Uterine curettes	373-376	ZENKER, dissecting and ligature forceps	118
Uterine depressors	353		
Uterine dilators	346-351		
Uterine elevating forceps	357		
Uterine manipulator	379		
Uterine scoops	377		
Uterine sounds	352		

	Página		Página
A		BIEMER, ganchos	253
Accesorios para power drills	220	BILLROTH, separadores	178
Accu power drill	219	BIRKETT, pinzas para preparaciones y ligaduras	65
Acumulador / cargador para power drills	221	Bisturías	129-134
Adaptadores	333	Bocas de carburo de tungsteno, perfil de estructura piramidal	136,137
ADSON, pinzas	76,77	BONNEY, pinzas de disección tungsteno TUC	87
ADSON, pinzas de disección tungsteno TUC	86	BOYNTON, porta-agujas tungsteno TUC	149
ADSON, pinzas hemostáticas	53	BOZEMANN, porta-agujas tungsteno TUC	145
ADSON, separadores autoestaticos	196,197	BRIDGE, pinzas para preparaciones y ligaduras	62
ADSON, tubos de aspiración	216	BRODIE, sondas	202
ADSON-ANDERSON, separadores autoestaticos	196	BROM, ganchos	252
ADSON-BABY, pinzas hemostáticas	53	BROPHY (SULLIVAN), tijeras finas	105
ADSON-BABY, separadores autoestaticos	198	BROPHY, pinzas de disección	81
ADSON-BROWN, pinzas de disección con dientes	77	BROPHY, pinzas de disección con dientes	81
ADSON-MICRO, pinzas de disección	76	BROWN-ADSON, pinzas de disección con dientes	77
ADSON-MICRO, pinzas de disección con dientes	76	BRUNNER, costotomos	238
ADSON-TOENNIS, tijeras para cirugía vasculares	102	BURFORD, separadores costales	250
ADSON-TOENNIS-DELICATE, tijeras tungsteno TUC	127	BYRD, tubos de aspiración	214
Adventitia, micro-tijeras	111,113	C	
AF-accesorios	326-331	Cables de conexión	326
Air power drill	219	Cables fibra óptica	332
ALEXANDER, periostótomos para costillas	235	CAIRNS, pinzas hemostáticas	50
ALLIS, pinzas para coger tejidos	38	Cámaras	339-341
ALLIS-ADAIR, pinzas para coger tejidos	38	Camisa para trocares y trocares	321-325
ALLIS-BABY, pinzas para coger tejidos	38	Cánulas de aspiración endoscopia	318,319
ALLISON, espátulas pulmonares	255	Canulas y tubos de aspiración	211-216
ALM, separadores autoestaticos	194	Cardiovascular	233-299
ANDERSON-ADSON, separadores autoestaticos	196	CARMALT-ROCHESTER, pinzas hemostáticas	55
ANDREWS-PYNCHON, tubos de aspiración	213	CARREL, pinzas hemostáticas	44
ANKENEY, separadores costales	242,243	CARROLL, porta-agujas tungsteno TUC	142
Aproximadores para costillas	254	CARTILAGE-MARTIN, tijeras	104
ARRUGA, porta-agujas tungsteno TUC	149	CASTANEDA, pinzas atrauma	294
Atrauma clamps bulldog	260-263	CASTANEDA, separadores costales	249
AUSTIN, pinzas de ligadura	82	CASTROVIEJO, micro-porta-agujas	160
B		CASTROVIEJO, micro-porta-agujas tungsteno TUC	152,153
BABCOCK, pinzas para coger intestinos	39	CHAPUT, pinzas hemostáticas	42
BABY-ADSON, pinzas hemostáticas	53	CHURCH, tijeras para cirugía vasculares	103
BABY-ADSON, separadores autoestaticos	198	Cizallas para huesos	237,238
BABY-CRILE-WOOD, porta-agujas tungsteno TUC	144	Clamps bulldog	40,41
BABY-MIXTER, pinzas para preparaciones y ligaduras	61	Clamps vena cava	298
BABY-OVERHOLT, pinzas para preparaciones y ligaduras	51	CLASSON, tijeras para cirugía vasculares	103
BABY-POOLE, tubos de aspiración	214	CLEVELAND, pinzas cortantes para huesos	230
BABY-SATINSKY, clamps vena cava	298	CLEVELAND-GARDNER, pinzas cortantes p.huesos	229
BABY-SENN-MILLER, separadores finas	176	Clips	257-259
BABY-WEITLANER, separadores autoestaticos	195	COLLER, pinzas hemostáticas	47
BACKHAUS, pinzas de campo	67	COLLIN, mangos de bisturías	132
BACKHAUS, pinzas para compresas	67	CONE, separadores autoestaticos	198
BADGLEY, separadores costales	240	CONVERSE, porta-agujas tungsteno TUC	143
BAILEY, aproximadores para costillas	254	COOLEY, dilatadores	299
BAILEY-BABY, aproximadores para costillas	254	COOLEY, dilatadores vasculares	204
BAILEY-GIBBON, aproximadores para costillas	254	COOLEY, pinzas atrauma	285-288,291
BAINBRIDGE, pinzas atrauma	268	COOLEY, separadores aurícula	256
BAINBRIDGE, pinzas hemostáticas	55	COOLEY, separadores costales	249
BALL & SOCKET, pinzas de campo	67	COOLEY, tubos de aspiración	215
BALL & SOCKET, pinzas para compresas	67	COOLEY-DERRA, pinzas atrauma	289
BALLENGER-FOERSTER, pinzas para esponjas	168	COOLEY-STRUCK, separadores aurícula	256
BARRAQUER, micro-porta-agujas con mango redondo	156	CORWIN, pinzas para torcer hilos tungsteno TUC	151
BARRAQUER-TROUTMAN, micro-porta-agujas con mango redondo	156	CORYLLOS, costotomos	237
BECK, pinzas atrauma	283,289	CORYLLOS, separadores	192
BECK-LUETHY, porta-agujas tungsteno TUC	150	Costotomos	237,238
BENGOLEA, pinzas hemostáticas	56	COTTLE KAZANJIAN, pinzas cortantes para huesos	229
BERNHARD, pinzas de campo	66	COUPLAND, tubos de aspiración	214
BERNHARD, pinzas para compresas	66	CRAFOORD, pinzas-clamps bronquias	58
BETHUNE, costotomos	237	CRAFOORD, tijeras	104
BEYER, pinzas-gubias	224	CRAFOORD-SELLORS, pinzas para aurícula	57
BIEMER, clips vasculares	258	CRILE, ganchos	252
		CRILE, pinzas hemostáticas	47

	Página		Página
CRILE-RANKIN, pinzas hemostáticas	47	Espátulas	251
CRILE-WOOD, porta-agujas tungsteno TUC	144	Espátulas pulmonares	255
CRILE-WOOD-BABY, porta-agujas tungsteno TUC	144	EUFRATE PASQUE, porta-agujas tungsteno TUC	141
CUSHING, ganchos	172,174,252	EWALD, pinzas de disección	77
CUSHING, pinzas de disección	80	EWALD, pinzas de disección con dientes	77
CUSHING, pinzas de disección con dientes	80	F	
CUSHING, pinzas de disección tungsteno TUC	86	FARRELL, porta-algodones	202
CUSHING, separadores espinales	176	FAVALORO, tijeras para cirugía vasculares	101
CUSHING-TAYLOR, pinzas de disección tungsteno TUC	86	FEIN, porta-algodones	203
D		FERGUSON, tubos de aspiración	216
DALE, pinzas atrauma	282	FINOCCHIETTO, porta-agujas tungsteno TUC	145
DANDY, pinzas hemostáticas para pericráneo	54	FINOCCHIETTO, separadores costales	241,248
DANDY, tijeras para cirugía vasculares	101	FINOCCHIETTO, tijeras	104
DARDIK, pinzas atrauma	290	FINOCCHIETTO-BABY, separadores costales	241
DAVIDSON, separadores	193	FINSEN, separadores autoestáticos	194
DAVIS, espátulas vasculares	251	FISCH, ganchos	253
DAVIS-RAGNELL, separadores finas	176	FOERSTER-BALLENGER, pinzas para esponjas	168
DE BAKEY, atrauma clamps bulldog	260	FOX-GOLDMAN, tijeras tungsteno TUC	127
DE BAKEY, dilatadores vasculares	205	FRANKENFELDT, pinzas para coger	207
DE BAKEY, pinzas atrauma	84	FRAZIER, tubos de aspiración	216
DE BAKEY, pinzas atrauma	267,269-273,275,279,284,295	FRENCH-EYE/Ryder, porta-agujas tungsteno TUC	141
DE BAKEY, pinzas de disección tungsteno TUC	87	FRYKHOLM, pinzas-gubias	227
DE BAKEY, porta-agujas tungsteno TUC	140	Fuentes de luz fría	332-338
DE BAKEY, separadores costales	245,246	FULTON, tijeras para cirugía vasculares	103
DE BAKEY, tijeras para cirugía vasculares	99,102	G	
DE BAKEY, tijeras tungsteno TUC	123	Ganchos	172-175,252,253
DE BAKEY, tubos de aspiración	213	GARRETT, dilatadores vasculares	204
DE BAKEY-BAHNSON, pinzas atrauma	275	GEISSENDOERFER-OVERHOLT, pinzas para preparaciones y ligaduras	51
DE BAKEY-CAROTIS, atrauma clamps bulldog	262	GEMINI, pinzas para preparaciones y ligaduras	63
DE BAKEY-HESS, clips vasculares	259	GERALD, pinzas de disección	80
DE BAKEY-MOSQUITO, pinzas atrauma	264	GERALD, pinzas de disección con dientes	80
DE BAKEY-PEAN, pinzas atrauma	265	GIERTZ-STILLE, costotomos	238
DE BAKEY-RANKIN, pinzas atrauma	264	GILLIES, ganchos	253
DE BAKEY-SATINSKY, atrauma clamps bulldog	262	GILLIES, pinzas de disección tungsteno TUC	85
DE MARTEL-POTTS, tijeras para cirugía vasculares	102	GILLIES, porta-agujas tungsteno TUC	146
DEAVER, separadores	187-189	GIL-VERNET, ganchos	175
DERF, porta-agujas tungsteno TUC	143	GLOVER, atrauma clamps bulldog	261
DERRA, pinzas atrauma	282	GLOVER, pinzas atrauma	283
DESMARRES, ganchos	174	GLUCK, costotomos	237
Desobliteradores de vasos	206	GOLDMAN-FOX, tijeras tungsteno TUC	127
DIEFFENBACH, clamps bulldog	41	GORNEY, pinzas para preparaciones	97
DIETRICH, micro-porta-agujas tungsteno TUC	153	GREEN-SENN, ganchos	173
DIETRICH-HEGEMANN, tijeras para cirugía vasculares	100	GREGORY, pinzas atrauma	281
DIETRICH, pinzas atrauma	281	GREGORY-SOFT, atrauma clamps bulldog	263
Dilatadores	299	GROSS-MAIER, pinzas para pólipos	166,167
Dilatadores vasculares	204,205	H	
Dissection, micro-tijeras	111,113	Haight, separadores costales	239
DIXON-LOVELACE, pinzas hemostáticas	54	HALSEY, porta-agujas tungsteno TUC	143
DOYEN, periostótomos para costillas	235	HALSTED, pinzas hemostáticas	46
DOYEN, pinzas de campo	66	HALSTED-MOSQUITO, pinzas hemostáticas	45
DOYEN, pinzas para compresas	66	HARKEN, clamps vena cava	298
DOYEN, separadores	185	HARKEN, pinzas atrauma	276
DOYEN, sondas	201	HARRINGTON, separadores	185
DUNHILL, pinzas hemostáticas	50	HARTMANN, pinzas hemostáticas	44
DUVAL, pinzas para coger intestinos	39	HEGAR, dilatadores	208,209
E		HEGAR-OLSEN, porta-agujas tungsteno TUC	146
easyClean	306-309	HEGEMANN-DIETRICH, tijeras para cirugía vasculares	100
ECHLIN, pinzas-gubias	227	HEISS, pinzas hemostáticas	58
EISELSBERG-MATHIEU, porta-agujas tungsteno TUC	150	HERTZLER, separadores costales	240
Electrodos	327,328	Hojas de bisturíes	133,134
Electrodos con tubo de succión	314-317,320	HOPKINS-JOHNS, clamps bulldog	41
Electrodos/Succión/Irrigación/Agujas/Trócares	314-325	HOPKINS-JOHNS, pinzas para poner	41
ENGL. MODELL, pinzas de campo	66	HOPKINS-JOHNS, pinzas para preparaciones y ligaduras	60
ENGL. MODELL, pinzas para compresas	66		

	Página		Página
HORNE-JOBSON, porta-algodones	203	LERICHE, pinzas hemostáticas	46
HÖSEL, porta-agujas tungsteno TUC	149	LEXER, tijeras para preparaciones	97
HOSPITAL-PROVIDENCE, pinzas hemostáticas	46	LEXER, tijeras tungsteno TUC	124
I		LICHTENBERG, porta-agujas tungsteno TUC	149
I.M.A. MAMMARIA, separadores costales	239	LINCOLN, tijeras para cirugía vasculares	103
Instrumental vascular y sondas	199-209	LISTER, tijeras tungsteno TUC	128
Instrumentos para huesos	217-232	LISTON, pinzas cortantes para huesos	229,232
Instrumentos para Laparoscopia / Tórax	306-313	LISTON-KEY, pinzas cortantes para huesos	231
ISRAEL, separadores	179	LITTAUER-LISTON, pinzas cortantes para huesos	229
J		LITTLER, tijeras finas	105
JACOBSON, micro-porta-agujas	160	LOCKHART-MUMMERY, sondas	202
JACOBSON, micro-porta-agujas tungsteno TUC	152	LORNA, pinzas de campo	67
JACOBSON, porta-agujas tungsteno TUC	142	LORNA, pinzas para compresas	67
JANSEN, separadores autoestáticos	194	LOTH-KLINKENBERGH, tijeras para cirugía vasculares	103
JAVID, pinzas atrauma	285	LOVELACE, pinzas clamps para pulmon	297
JEWELER, pinzas de disección tungsteno TUC	85	LOVELACE-DIXON, pinzas hemostáticas	54
JOBSON-HORNE, porta-algodones	203	LUETHY-BECK, porta-agujas tungsteno TUC	150
JOHNS-HOPKINS, clamps bulldog	41	M	
JOHNS-HOPKINS, pinzas para poner	41	MAIER-GROSS, pinzas para pólipos	166,167
JOHNS-HOPKINS, pinzas para preparaciones y ligaduras	60	Mangos de bisturíes	131-133
JONES, pinzas de campo	66	MARKWALDER, pinzas cortantes para huesos	229
JONES, pinzas para compresas	66	MARQUARDT, pinzas-gubias	224
JOSEPH, tijeras para preparaciones	98	MARTIN, separadores	184
K		MARTIN-CARTILAGE, tijeras	104
KADER, separadores	191	MASSON, porta-agujas tungsteno TUC	145
KALT, micro-porta-agujas tungsteno TUC	153	MATHIEU, porta-agujas tungsteno TUC	147
KANTROWITZ, pinzas para preparaciones y ligaduras	63	MATHIEU-DELICATE, porta-agujas tungsteno TUC	147
KAYE, tijeras para Face-lift TUC	127	MATHIEU-EISELSBERG, porta-agujas tungsteno TUC	150
KELLY, pinzas hemostáticas	47	MATHIEU-RYDER VASCULAR, porta-agujas tungsteno TUC	148
KELLY, separadores	186	MATHIEU-RYDER, porta-agujas tungsteno TUC	148
KELLY-RANKIN, pinzas hemostáticas	47	MATSON, periostótomos para costillas	235
KILNER (RAGNELL), tijeras para preparaciones	98	MAYFIELD, pinzas-gubias	224
KILNER, ganchos	253	MAYO, tijeras tungsteno TUC	119
KILNER, porta-agujas tungsteno TUC	143	MAYO-HEGAR, porta-agujas tungsteno TUC	140
KLINIKUM BERLIN, pinzas para tubos	68	MAYO-HEGAR-DELICATE, porta-agujas tungsteno TUC	140
KLINKENBERGH-LOTH, tijeras para cirugía vasculares	103	MC INDOE, pinzas cortantes para huesos	230
KOCHER, separadores	177,182	MC INDOE, pinzas de disección	77
KOCHER-DELICATE, pinzas hemostáticas	50	MC INDOE, tijeras	104
KOCHER-LANGENBECK, separadores	181	MEEKER, pinzas para preparaciones y ligaduras	53
KOCHER-OCHSNER, pinzas hemostáticas	49	MEHDORN, clips vasculares	258
KOERTE, separadores	178,189	METZENBAUM, porta-agujas tungsteno TUC	147
KRAYENBÜHL, ganchos	252	METZENBAUM, tijeras tungsteno TUC	121,122
KROENLEIN, pinzas hemostáticas	43	METZENBAUM-DELICATE, tijeras para preparaciones	96
L		METZENBAUM-DELICATE, tijeras tungsteno TUC	124-126
LAMBERT-KAY, pinzas atrauma	275	METZENBAUM-NELSON, tijeras para preparaciones	95
LAMBOTTE, periostótomos para costillas	236	MEYERDING, ganchos	173
LANDOLT, tijeras finas	106	Micro tijeras	110-116
LANE, pinzas de campo	66	Micro, tijeras Adventitia	111,113
LANE, pinzas de disección	79	Micro, tijeras Dissection	111,113
LANE, pinzas para compresas	66	Micro, tijeras Nerve	113
LANGENBECK, porta-agujas tungsteno TUC	150	MICRO-ADSON, pinzas de disección	76
LANGENBECK, separadores	180	MICRO-ADSON, pinzas de disección con dientes	76
LANGENBECK-DELICATE, porta-agujas tungsteno TUC	150	MICRO-MOSQUITO, pinzas hemostáticas	45
LANGENBECK-KOCHER, separadores	181	Micro-pinzas	82,83
LANGENBECK-MINI, ganchos	173	Micro-porta-agujas	160,161
LANGENBECK-RYDER, porta-agujas tungsteno TUC	150	Micro-porta-agujas con bocas de carburo de tungsteno	152,153
LAWRENCE, pinzas para preparaciones y ligaduras	62	Micro-porta-agujas con mango redondo	156-159
LEBSCHKE, costotomos	238	MICRO-RYDER, porta-agujas tungsteno TUC	141
LEES, pinzas atrauma	278	MICROVASCULAR, porta-agujas TUC	141
LEKSELL-STILLE, pinzas-gubias	226	MIKULICZ, separadores	186
LELAND-JONES, pinzas atrauma	268	MILLER-SENN, separadores finas	176
		MILLS, tijeras para cirugía vasculares	102
		MINI, hojas de bisturíes	133
		MINI, mangos de bisturíes	133
		MINI-LANGENBECK, ganchos	173
		MIXTER, pinzas para preparaciones y ligaduras	61,62
		MIXTER-BABY, pinzas para preparaciones y ligaduras	61

	Página		Página
MIXTER-O'SHAUGNESSY, pinzas para preparaciones y ligaduras	61	Pinzas para preparaciones y ligaduras	51-53,57,59-65
MIXTER-OVERHOLT, pinzas para preparaciones y ligaduras	57	Pinzas para torcer hilos tungsteno TUC	151
MOD. BONN, tijeras finas	106	Pinzas para tubos	68
MODELL TÜBINGEN, separadores	184	Pinzas, micro	82,83
MOLDESTADT, ganchos	172	Pinzas-clamps bronquiales	297
MORRIS, separadores	183	Pinzas-clamps bronquiales	58
MORRIS-DE BAKEY, pinzas atrauma	280	Pinzas-clamps para pulmón	297
MORSE FAVALORO, separadores costales	247	Pinzas-gubias	224-228
MOSQUITO-HALSTED, pinzas hemostáticas	45	PLESTER, tubos de aspiración	216
MOSQUITO-MICRO, pinzas hemostáticas	45	POOLE, tubos de aspiración	214
MÜLLER, clips vasculares	259	POOLE-BABY, tubos de aspiración	214
MUMMERY-LOCKHART, sondas	202	Porta-agujas con bocas de carburo de tungsteno	140-155
MYRTLE LEAF, sondas	201	Porta-aldodones	202,203
N		POTTS, pinzas atrauma	266
NABATOFF, sondas para várices	203	POTTS-DE MARTEL, tijeras para cirugía vasculares	102
NEIVERT, porta-agujas tungsteno TUC	143	POTTS-SMITH, micro-porta-agujas tungsteno TUC	153
NELATON, sondas	201	POTTS-SMITH, pinzas de disección	81
NELSON-METZENBAUM, tijeras para preparaciones	95	POTTS-SMITH, pinzas de disección con dientes	81
Nerve, micro tijeras	113	POTTS-SMITH, pinzas de disección tungsteno TUC	85
NEW ORLEANS, porta-agujas tungsteno TUC	142	POTTS-SMITH, tijeras	104
nopa DIAMOND, porta agujas	154,155	POTTS-SMITH, tijeras para cirugía vasculares	99,101
O		POTTS-SMITH, tijeras tungsteno TUC	123
O'BRIEN, tijeras finas	106	PRATT, sondas	202
OCHSNER, pinzas atrauma	281	PRESBYTERIAN, pinzas para tubos	68
OCHSNER-KOCHER, pinzas hemostáticas	49	PRICE-THOMAS, pinzas clamps bronquiales	297
OEHLER, pinzas de disección tungsteno TUC	85	PROVIDENCE-HOSPITAL, pinzas hemostáticas	46
OLLIER, separadores	179	PYNCHON-ANDREWS, tubos de aspiración	213
OLSEN-HEGAR, porta-agujas tungsteno TUC	146	R	
Opticas	304,305	RAGNELL (KILNER), tijeras para preparaciones	98
O'SHAUGNESSY-MIXTER, pinzas para preparaciones y ligaduras	61	RAGNELL-DAVIS, separadores finas	176
OVERHOLT, pinzas para preparaciones y ligaduras	52	RAMPLEY, pinzas para esponjas	169
OVERHOLT-BABY, pinzas para preparaciones y ligaduras	51	RANKIN-CRILE, pinzas hemostáticas	47
OVERHOLT-GEISSENDOERFER, pinzas para preparaciones y ligaduras	51	RANKIN-KELLY, pinzas hemostáticas	47
OVERHOLT-MIXTER, pinzas para preparaciones y ligaduras	57	REILL, micro-porta-agujas con mango redondo	157
P		REYNOLDS, tijeras para preparaciones	98
PEAN, pinzas hemostáticas	43	ROBERTS, pinzas hemostáticas	58
PEAN-DELICATE, pinzas hemostáticas	50	ROCHESTER-CARMALT, pinzas hemostáticas	55
PEAN-ROCHESTER, pinzas hemostáticas	48	ROCHESTER-PEAN, pinzas hemostáticas	48
PEERS, pinzas de campo	67	ROEDER, pinzas de campo	67
PEERS, pinzas para compresas	67	ROEDER, pinzas para compresas	67
PENFIELD, espátulas	251	ROETTGEN-RUSKIN, pinzas-gubias	226
Periostótomos para costillas	235,236	RUMEL, pinzas para preparaciones y ligaduras	59
Pinzas	71-87	RUMEL-BELMONT, torniquetes	299
Pinzas atrauma	84	RUSKIN, pinzas-gubias	224,228
Pinzas atrauma	264-296	RUSKIN-LISTON, pinzas cortantes para huesos	230
Pinzas cortantes para huesos	229-232	RYDER/FRENCH-EYE, porta-agujas tungsteno TUC	141
Pinzas de aprehensión endoscopia	307-312	RYDER-LANGENBECK, porta-agujas tungsteno TUC	150
Pinzas de campo	66,67	RYDER-MATHIEU VASCULAR, porta-agujas tungsteno TUC	148
Pinzas de disección con bocas de carburo de tungsteno	85-87	RYDER-MATHIEU, porta-agujas tungsteno TUC	148
Pinzas de ligadura con plataforma	82,83	RYDER-MICRO, porta-agujas tungsteno TUC	141
Pinzas hemostáticas	35-68	S	
Pinzas hemostáticas delgadas	50	SANTULLI, atrauma clamps bulldog	260
Pinzas hemostáticas finas	45	SANVENERO, tijeras para preparaciones	98
Pinzas hemostáticas para amígdalas	55	SAROT, pinzas-clamps bronquiales	58
Pinzas monopolares	329	SAROT, porta-agujas tungsteno TUC	145
Pinzas para aurícula	57	SATINSKY, clamps vena cava	298
Pinzas para coger intestinos	39	SATINSKY, pinzas atrauma	272,274
Pinzas para coger tejidos	38	SATINSKY, tijeras para cirugía vasculares	103
Pinzas para compresas	66,67	SAUERBRUCH, costotomos	237
Pinzas para hilos	222,223	SAUERBRUCH, pinzas-gubias	227
Pinzas para la Bi-Coagulación	331	SAUERBRUCH, separadores	182,192
Pinzas para polipos	163-169	SAWTELL-SCHNIDT, pinzas hemostáticas para amígdalas	55
Pinzas para poner	41	SCHAEDEL, pinzas de campo	66
		SCHAEDEL, pinzas para compresas	66

Página

SCHMID, espátulas vasculares	251	Tijeras para enterótomos	104
SCHMIEDEN-TAYLOR, tijeras para cirugía vasculares	102	Tijeras para Face-lift TUC	127
SCHNIDT-SAWTELL, pinzas hemostáticas para amígdalas	55	Tijeras para iridectomía	107
SELLORS, aproximadores para costillas	254	Tijeras para lobectomía	104
SELLORS-CRAFOORD, pinzas para aurícula	57	Tijeras para nervios	97
SEMB, periostótomos para costillas	236	Tijeras para preparaciones	95-98
SEMB, pinzas clamps bronquiales	297	Tijeras Super-Cut SC	91
SEMB, pinzas cortantes para huesos	232	tini instruments (titan-nitride surface coating)	69,70
SEMB, pinzas-gubias	225	titan instruments	37,73,93,116,139
SEMKEN, pinzas de disección	77,78	TOENNIS, pinzas para preparaciones y ligaduras	64
SEMKEN, pinzas de disección con dientes	77,78	TOENNIS, porta-agujas tungsteno TUC	149
SEMKEN, pinzas de disección tungsteno TUC	85	TOENNIS, tijeras para cirugía vasculares	102
SENN-GREEN, ganchos	173	TOENNIS-ADSON, tijeras para cirugía vasculares	102
SENNING (SWEDISH PATTERN), porta-agujas tungsteno TUC	142	TOENNIS-ADSON-DELICATE, tijeras tungsteno TUC	127
SENN-MILLER, separadores finas	176	TOHOKU-JAPAN, pinzas de campo	67
SENN-MILLER-BABY, separadores finas	176	TOHOKU-JAPAN, pinzas para compresas	67
Separadores aurícula	256	TÖNNIS, espátulas vasculares	251
Separadores	171-198	Toracoscopia	301-343
Separadores costales	239-250	Torniquetes	299
Separadores endoscopia	313	TROUTMAN, micro-porta-agujas con mango redondo	157
Separadores espinales	176	TROUTMAN-BARRAQUER, micro-porta-agujas con mango redondo	156
Separadores finas	176	TUBBS, dilatadores	299
SIMON, separadores	184	TÜBINGER MODELL, separadores	184
Sistema de brazo articulado con fijación central	342,343	Tubos de aspiración y canulas	211-216
SMITH-PETERSON, pinzas-gubias	228	TUDOR-EDWARDS, pinzas cortantes para huesos	231
SMITH-POTTS, micro-porta-agujas tungsteno TUC	153	TUFFIER, pinzas hemostáticas	42
SMITH-POTTS, pinzas de disección tungsteno TUC	85	TUFFIER, separadores	185
SMITH-POTTS, tijeras para cirugía vasculares	99,101	TUFFIER, separadores costales	240
SNITMAN, separadores autoestáticos	194		
Sondas	201,202	U	
Sondas para várices	203	UCKERMANN, porta-algodones	203
Sondas y instrumental vascular	199-209	ULRICH, pinzas para pólipos	165
SPENCER-WELLS, pinzas hemostáticas	44	UNIVERSAL, tijeras tungsteno TUC	128
STACKE, sondas	201		
STANDARD, pinzas de disección	75	V	
STANDARD, pinzas de disección con dientes	75	VERNET-GIL, ganchos	175
STANDARD, tijeras tungsteno TUC	118,119	VOLKMANN, separadores	177,178
STERNUM, pinzas para torcer hilos tungsteno TUC	151		
STEVENS, tijeras para tenotomía	109	W	
STEVENS, tijeras tungsteno TUC	127	WALTON, tijeras finas	106
STILLE, pinzas-gubias	225	WALTON-LISTON, pinzas cortantes para huesos	230
STILLE-LISTON, pinzas cortantes para huesos	231	WALTON-YANKAUER, tubos de aspiración	213
STILLE-LUER, pinzas-gubias	226	WANGENSTEEN, pinzas de disección tungsteno TUC	87
STILLE-RUSKIN, pinzas-gubias	225	WANGENSTEEN, porta-agujas tungsteno TUC	145
STRATTE, porta-agujas tungsteno TUC	145	WEBER, pinzas atrauma	277
STRULLY, tijeras para cirugía vasculares	101	WEBSTER, porta-agujas tungsteno TUC	143
SUBRAMANIAN, pinzas atrauma	296	WEITLANER, separadores autoestáticos	195
SUBRAMANIAN-MINIATURE, pinzas atrauma	296	WEITLANER-BABY, separadores autoestáticos	195
SULLIVAN (BROPHY), tijeras finas	105	WELLS-SPENCER, pinzas hemostáticas	44
Super Cut Tijeras SC	91	WERTHEIM, porta-agujas tungsteno TUC	146
Super Cut tijeras SC con fillos de carburo de tungsteno TUC	117	WIKSTROEM, pinzas para preparaciones y ligaduras	65
Sutura	135-161		
T		Y	
TAYLOR, pinzas de disección	78,79	YANKAUER, tubos de aspiración	213
TAYLOR, pinzas de disección con dientes	78,79	YANKAUER-WALTON, tubos de aspiración	213
TAYLOR, separadores espinales	176		
TAYLOR-CUSHING, pinzas de disección tungsteno TUC	86	Z	
TAYLOR-SCHMIEDEN, tijeras para cirugía vasculares	102	ZAUFAL-JANSEN, pinzas-gubias	224
TERRIER, pinzas hemostáticas	44	ZENKER, pinzas para preparaciones y ligaduras	60
Tijeras	89-128	ZENKER, separadores	190
Tijeras con fillos de carburo de tungsteno	118-128	ZWEIFEL, porta-agujas tungsteno TUC	150
Tijeras coronarias	101		
Tijeras finas	105-109		
Tijeras micro	110-116		
Tijeras para cartilago	104		
Tijeras para cirugía vasculares	99-103		
Tijeras para disección	104		

Index

	Page		Page
A			
Accessoires pour power drills	220	BONNEY, pinces à dissection tungstène TUC	87
Accu power drill	219	BOYNTON, porte-aiguilles tungstène TUC	149
Accumulateur / chargeur d'accus	221	BOZEMANN, porte-aiguilles tungstène TUC	145
Adaptateur	333	BRIDGE, pinces à dissection et à ligatures	62
ADSON, canules d'aspiration	216	BRODIE, sondes	202
ADSON, écarteurs autostatiques	196,197	BROM, crochets très fins	252
ADSON, pinces	76,77	BROPHY (SULLIVAN), ciseaux fins	105
ADSON, pinces à dissection et à ligatures	53	BROPHY, pinces à dissection et à griffes	81
ADSON, pinces à dissection tungstène TUC	86	BROWN-ADSON, pinces à griffes	77
ADSON-ANDERSON, écarteurs autostatiques	196	BRUNNER, costotomes	238
ADSON-BABY, écarteurs autostatiques	198	Bulldog clamps	40,41
ADSON-BABY, pinces à dissection et à ligatures	53	BURFORD, écarteurs des côtes	250
ADSON-BROWN, pinces à griffes	77	BYRD, canules d'aspiration	214
ADSON-MICRO, pinces à dissection et à griffes	76	C	
ADSON-TOENNIS, ciseaux vasculaires	102	Câbles de raccordement	326
ADSON-TOENNIS-DELICATE, ciseaux tungstène TUC	127	Câbles fibre optique	332
Adventitia, micro-ciseaux	111,113	CAIRNS, pinces hémostatiques	50
Air power drill	219	Caméras	339-341
ALEXANDER, rugines raspatoires	235	Canules d'aspiration endoscopie	318,319
ALLIS, pinces pour saisir le tissu	38	Canules et tubes d'aspiration	211-216
ALLIS-ADAIR, pinces pour saisir le tissu	38	Cardiovasculaire	233-299
ALLIS-BABY, pinces pour saisir le tissu	38	CARMALT-ROCHESTER, pinces hémostatiques	55
ALLISON, spatules pulmonaires	255	CARREL, pinces hémostatiques	44
ALM, écarteurs autostatiques	194	CARROLL, porte-aiguilles tungstène TUC	142
ANDERSON-ADSON, écarteurs autostatiques	196	CARTILAGE-MARTIN, ciseaux	104
ANDREWS-PYNCHON, canules d'aspiration	213	CASTANEDA, écarteurs des côtes	249
ANKENEY, écarteurs des côtes	242,243	CASTANEDA, pinces atraumatiques	294
ARRUGA, porte-aiguilles tungstène TUC	149	CASTROVIEJO, micro-porte-aiguilles	160
AUSTIN, pinces à ligatures avec plate-forme	82	CASTROVIEJO, micro-porte-aiguilles tungstène TUC	152,153
B			
BABCOCK, pinces pour saisir l'intestin	39	CHAPUT, pinces hémostatiques	42
BABY-ADSON, pinces à dissection	53	CHURCH, ciseaux vasculaires	103
BABY-CRILE-WOOD, porte-aiguilles tungstène TUC	144	Cisailles pour os	237,238
BABY-MIXTER, pinces à dissection et à ligatures	61	Ciseaux	89-128
BABY-OVERHOLT, pinces à dissection et à ligatures	51	Ciseaux à dissection	95-98
BABY-POOLE, canules d'aspiration	214	Ciseaux à épisiotomie	104
BABY-SATINSKY, pinces vena cava	298	Ciseaux à iridectomie	107
BABY-SENN-MILLER, écarteurs fins	176	Ciseaux à lobectomie	104
BABY-WEITLANER, écarteurs autostatiques	195	Ciseaux à préparation	104
BACKHAUS, pinces à champs	67	Ciseaux avec plaquettes en carbure de tungstène	118-128
BADGLEY, écarteurs des côtes	240	Ciseaux coronaires	101
BAILEY, rapprocheurs des côtes	254	Ciseaux fins	105-109
BAILEY-BABY, rapprocheurs des côtes	254	Ciseaux pour chirurgie vasculaire	99-103
BAILEY-GIBBON, rapprocheurs des côtes	254	Ciseaux pour Face-lift TUC	127
BAINBRIDGE, pinces atraumatiques	268	Ciseaux pour le cartilage	104
BAINBRIDGE, pinces hémostatiques	55	Ciseaux pour nerfs	97
BALL & SOCKET, pinces a champs	67	Ciseaux super cut SC	91
BALLENGER-FOERSTER, pinces à éponges	168	Ciseaux super cut SC avec plaquettes en carbure de tungstène TUC	117
BARRAQUER, micro-porte-aiguilles à manches rondes	156	Clamps atrauma bulldog	260-263
BARRAQUER-TROUTMAN, micro porte-aiguilles à manches rondes	156	Clamps bulldog	40,41
BECK, pinces atraumatiques	283,289	CLASSON, ciseaux vasculaires	103
BECK-LUETHY, porte-aiguilles tungstène TUC	150	CLEVELAND, pinces coupantes à os	230
BENGOLEA, pinces hémostatiques	56	CLEVELAND-GARDNER, pinces coupantes à os	229
BERNHARD, pinces à champs	66	Clips	257-259
BETHUNE, costotomes	237	COLLER, pinces hémostatiques	47
BEYER, pinces-gouges	224	COLLIN, manches pour bistouris	132
BIEMER, clips vasculaires	258	CONE, écarteurs autostatiques	198
BIEMER, crochets très fins	253	CONVERSE, porte-aiguilles tungstène TUC	143
BILLROTH, écarteurs	178	COOLEY, canules d'aspiration	215
BIRKETT, pinces à dissection et à ligatures	65	COOLEY, dilateurs	299
Bistouris	129-134	COOLEY, dilateurs vasculaires	204
		COOLEY, écarteurs à atrium	256
		COOLEY, écarteurs des côtes	249
		COOLEY, pinces atraumatiques	285-288,291

	Page		Page
COOLEY-DERRA, pinces atraumatiques	289	E	
COOLEY-STRUCK, écarteurs à atrium	256		
CORWIN, pinces à torsader le fil tungstène TUC	151	easyClean	306-309
CORYLLOS, costotomes	237	Ecarteurs	171-198
CORYLLOS, écarteurs	192	Ecarteurs à atrium	256
Costotomes	237,238	Ecarteurs des côtes	239-250
COTTLE KAZANJIAN, pinces coupantes à os	229	Ecarteurs endoscopie	313
COUPLAND, canules d'aspiration	214	Ecarteurs fins	176
CRAFOORD, ciseaux	104	Ecarteurs spinaux	176
CRAFOORD, pinces-clamps à bronches	58	ECHLIN, pinces-gouges	227
CRAFOORD-SELLORS, pinces auriculaires	57	EISELSBERG-MATHIEU, porte-aiguilles tungstène TUC	150
CRILE, crochets très fins	252	Electrodes	327,328
CRILE, pinces hémostatiques	47	Electrodes avec canule d'aspiration	314-317,320
CRILE-RANKIN, pinces hémostatiques	47	Electrodes/Aspiration/Irrigation/Canules/Trocarts	314-325
CRILE-WOOD, porte-aiguilles tungstène TUC	144	ENGL. MODELL, pinces à champs	66
CRILE-WOOD-BABY, porte-aiguilles tungstène TUC	144	EUFRATE-PASQUE, porte-aiguilles tungstène TUC	141
Crochets très fins	172-175,252,253	EWALD, pinces à dissection et à griffes	77
CUSHING, crochets très fins	172,174,252		
CUSHING, écarteurs spinaux	176	F	
CUSHING, pinces à dissection et à griffes	80	FARREL, porte-coton	202
CUSHING, pinces à dissection tungstène TUC	86	FAVALORO, ciseaux vasculaires	101
CUSHING-TAYLOR, pinces à dissection tungstène TUC	86	FEIN, porte-coton	203
D		FERGUSON, canules d'aspiration	216
DALE, pinces atraumatiques	282	FINOCCHIETTO, ciseaux	104
DANDY, ciseaux vasculaires	101	FINOCCHIETTO, écarteurs des côtes	241,248
DANDY, pinces hémostatiques pour le cuir chevelu	54	FINOCCHIETTO, porte-aiguilles tungstène TUC	145
DARDIK, pinces atraumatiques	290	FINOCCHIETTO-BABY, écarteurs des côtes	241
DAVIDSON, écarteurs	193	FINSEN, écarteurs autostatiques	194
DAVIS, spatules vasculaires	251	FISCH, crochets très fins	253
DAVIS-RAGNELL, écarteurs fins	176	FOERSTER-BALLENGER, pinces à éponges	168
DE BAKEY, canules d'aspiration	213	FOX-GOLDMAN, ciseaux tungstène TUC	127
DE BAKEY, ciseaux tungstène TUC	123	FRANKENFELDT, pinces pour saisir	207
DE BAKEY, ciseaux vasculaires	99,102	FRAZIER, canules d'aspiration	216
DE BAKEY, clamps atrauma bulldog	260	FRENCH-EYE-RYDER, porte-aiguilles tungstène TUC	141
DE BAKEY, dilateurs vasculaires	205	FRYKHOLM, pinces-gouges	227
DE BAKEY, écarteurs des côtes	245,246	FULTON, ciseaux vasculaires	103
DE BAKEY, pinces à dissection tungstène TUC	87	G	
DE BAKEY, pinces atrauma	84	GARRETT, dilateurs vasculaires	204
DE BAKEY, pinces atraumatiques	267,269-273,275,279,284,295	GEISSENDOERFER-OVERHOLT, pinces à dissection et à ligatures	51
DE BAKEY, porte-aiguilles tungstène TUC	140	GEMINI, pinces à dissection et à ligatures	63
DE BAKEY-BAHNSON, pinces atraumatiques	275	GERALD, pinces à dissection et à griffes	80
DE BAKEY-CAROTIS, clamps atrauma bulldog	262	GIERTZ-STILLE, costotomes	238
DE BAKEY-HESS, clips vasculaires	259	GILLIES, crochets très fins	253
DE BAKEY-MOSQUITO, pinces atraumatiques	264	GILLIES, pinces à dissection tungstène TUC	85
DE BAKEY-PEAN, pinces atraumatiques	265	GILLIES, porte-aiguilles tungstène TUC	146
DE BAKEY-RANKIN, pinces atraumatiques	264	GIL-VERNET, écarteurs fins	175
DE BAKEY-SATINSKY, clamps atrauma bulldog	262	GLOVER, clamps atrauma bulldog	261
DE MARTEL-POTTS, ciseaux vasculaires	102	GLOVER, pinces atraumatiques	283
DEAVER, écarteurs	187-189	GLUCK, costotomes	237
DERF, porte-aiguilles tungstène TUC	143	GOLDMAN-FOX, ciseaux tungstène TUC	127
DERRA, pinces atraumatiques	282	GORNEY, ciseaux à dissection	97
DESMARRES, crochets très fins	174	GREEN-SENN, écarteurs fins	173
DIEFFENBACH, clamps bulldog	41	GREGORY, pinces atraumatiques	281
DIETRICH, micro-porte-aiguilles tungstène TUC	153	GREGORY-SOFT, clamps atrauma bulldog	263
DIETRICH-HEGEMANN, ciseaux vasculaires	100	GROSS-MAIER, pinces à pansements	166,167
DIETRICH, pinces atraumatiques	281		
Dilatateurs	299	H	
Dilatateurs vasculaires	204,205	HAIGHT, écarteurs des côtes	239
Dissection, micro-ciseaux	111,113	HALSEY, porte-aiguilles tungstène TUC	143
DIXON-LOVELACE, pinces hémostatiques	54	HALSTED, pinces hémostatiques	46
DOYEN, écarteurs	185	HALSTED-MOSQUITO, pinces hémostatiques	45
DOYEN, pinces à champs	66	HARKEN, pinces atraumatiques	276
DOYEN, rugines raspatoires	235	HARKEN, pinces vena cava	298
DOYEN, sondes	201	HARRINGTON, écarteurs	185
DUNHILL, pinces hémostatiques	50	HARTMANN, pinces hémostatiques	44
DUVAL, pinces pour saisir l'intestin	39		

	Page		Page
HEGAR, dilateurs	208,209	LANGENBECK-KOCHER, écarteurs	181
HEGAR-OLSEN, porte-aiguilles tungstène TUC	146	LANGENBECK-MINI, écarteurs fins	173
HEGEMANN-DIETRICH, ciseaux vasculaires	100	LANGENBECK-RYDER, porte-aiguilles tungstène TUC	150
HEISS, pinces-clamps à bronches	58	LAWRENCE, pinces à dissection et à ligatures	62
HERTZLER, écarteurs des côtes	240	LEBSCHE, costotomes	238
HF-accessoires	326-331	LEES, pinces atraumatiques	278
HOPKINS-JOHNS, clamps bulldog	41	LEKSELL-STILLE, pinces-gouges	226
HOPKINS-JOHNS, pinces à dissection et à ligatures	60	LELAND-JONES, pinces atraumatiques	268
HOPKINS-JOHNS, pinces à poser	41	LERICHE, pinces hémostatiques	46
HORNE-JOBSON, porte-coton	203	LEXER, ciseaux à dissection	97
HÖSEL, porte-aiguilles tungstène TUC	149	LEXER, ciseaux tungstène TUC	124
HOSPITAL-PROVIDENCE, pinces hémostatiques	46	LICHTENBERG, porte-aiguilles à mors en carbure de tungstène	149
I		LINCOLN, ciseaux vasculaires	103
I.M.A. MAMMARIA, écarteurs des côtes	239	LISTER, ciseaux tungstène TUC	128
Instruments des os	217-232	LISTON, pinces coupantes à os	229,232
Instruments pour Laparoscopie / Thorax	306-313	LISTON-KEY, pinces coupantes à os	231
Instruments vaisseaux et sondes	199-209	LITTAUER-LISTON, pinces coupantes à os	229
ISRAEL, écarteurs	179	LITTLER, ciseaux fins	105
J		LOCKHART-MUMMERY, sondes	202
JACOBSON, micro-porte-aiguilles	160	LORNA, pinces à champs	67
JACOBSON, micro-porte-aiguilles tungstène TUC	152	LOTH-KLINKENBERGH, ciseaux vasculaires	103
JACOBSON, porte-aiguilles tungstène TUC	142	LOVELACE, pinces-clamps à poumons	297
JANSEN, écarteurs autostatiques	194	LOVELACE-DIXON, pinces hémostatiques	54
JAVID, pinces atraumatiques	285	LUETHY-BECK, porte-aiguilles tungstène TUC	150
JEWELER, pinces à dissection tungstène TUC	85	M	
JOBSON-HORNE, porte-coton	203	MAIER-GROSS, pinces à pansements	166,167
JOHNS-HOPKINS, clamps bulldog	41	Manches pour bistouris	131-133
JOHNS-HOPKINS, pinces à dissection et à ligatures	60	MARKWALDER, pinces coupantes à os	229
JOHNS-HOPKINS, pinces à poser	41	MARQUARDT, pinces-gouges	224
JONES, pinces à champs	66	MARTIN, écarteurs	184
JOSEPH, ciseaux à dissection	98	MARTIN-CARTILAGE, ciseaux	104
K		MASSON, porte-aiguilles tungstène TUC	145
KADER, écarteurs	191	MATHIEU, porte-aiguilles tungstène TUC	147
KALT, micro-porte-aiguilles tungstène TUC	153	MATHIEU-DELICATE, porte-aiguilles tungstène TUC	147
KANTROWITZ, pinces à dissection et à ligatures	63	MATHIEU-EISELSBERG, porte-aiguilles tungstène TUC	150
KAYE, ciseaux pour Face-lift TUC	127	MATHIEU-RYDER VASCULAR, porte-aiguilles tungstène TUC	148
KELLY, écarteurs	186	MATHIEU-RYDER, porte-aiguilles tungstène TUC	148
KELLY, pinces hémostatiques	47	MATSON, rugines raspatoires	233
KELLY-RANKIN, pinces hémostatiques	47	MAYFIELD, pinces-gouges	224
KILNER (RAGNELL), ciseaux à dissection	98	MAYO, ciseaux tungstène TUC	119
KILNER, crochets très fins	253	MAYO-HEGAR, porte-aiguilles tungstène TUC	140
KILNER, porte-aiguilles tungstène TUC	143	MAYO-HEGAR-DELICATE, porte-aiguilles tungstène TUC	140
KLINIKUM BERLIN, presses-tube	68	MC INDOE, ciseaux	104
KLINKENBERGH-LOTH, ciseaux vasculaires	103	MC INDOE, pinces à dissection	77
KOCHER, écarteurs	177,182	MC INDOE, pinces coupantes à os	230
KOCHER-DELICATE, pinces hémostatiques	50	MEEKER, pinces à dissection et à ligatures	53
KOCHER-LANGENBECK, écarteurs	181	MEHDORN, clips vasculaires	258
KOCHER-OCHSNER, pinces hémostatiques	49	METZENBAUM, ciseaux tungstène TUC	121,122
KOERTE, écarteurs	178,189	METZENBAUM, porte-aiguilles tungstène TUC	147
KRAYENBÜHL, crochets très fins	252	METZENBAUM-DELICATE, ciseaux à dissection	96
KROENLEIN, pinces hémostatiques	43	METZENBAUM-DELICATE, ciseaux tungstène TUC	124-126
L		METZENBAUM-NELSON, ciseaux à dissection	95
LAMBERT-KAY, pinces atraumatiques	275	MEYERDING, écarteurs fins	173
LAMBOTTE, rugines raspatoires	236	MICRO-ADSON, pinces à dissection et à griffes	76
Lames de bistouris	133,134	Micro-ciseaux	110-116
LANDOLT, ciseaux fins	106	Micro-ciseaux, Adventitia	111,113
LANE, pinces à champs	66	Micro-ciseaux, Dissection	111,113
LANE, pinces à griffes	79	Micro-ciseaux, Nerve	113
LANGENBECK, écarteurs	180	MICRO-MOSQUITO, pinces hémostatiques	45
LANGENBECK, porte-aiguilles tungstène TUC	150	Micro-pinces	82,83
LANGENBECK-DELICATE, porte-aiguilles tungstène TUC	150	Micro-porte-aiguilles	160,161
		Micro-porte-aiguilles à manches rondes	156-159
		Micro-porte-aiguilles tungstène TUC	152,153
		MICRO-RYDER, porte-aiguilles tungstène TUC	141
		MICROVASCULAR, porte-aiguilles tungstène TUC	141
		MIKULICZ, écarteurs	186
		MILLS, ciseaux vasculaires	102

	Page		Page
MINI, lames de bistouris	133	Pincés hémostatiques pour amygdales	55
MINI, manches de bistouris	133	Pincés micro	82,83
MINI-LANGENBECK, écarteurs fins	173	Pincés monopolaires	329
MIXTER, pincés à dissection et à ligatures	61,62	Pincés pour la bi-coagulation	331
MIXTER-BABY, pincés à dissection et à ligatures	61	Pincés pour saisir le tissu	38
MIXTER-O'SHAUGNESSY, pincés à dissection et à ligatures	61	Pincés pour saisir l'intestin	39
MIXTER-OVERHOLT, pincés à dissection et à ligatures	57	Pincés vena cava	298
MOD. BONN, ciseaux fins	106	Pincés-clamps à bronches	58,297
MODELL TÜBINGEN, écarteurs	184	Pincés-clamps à poumons	297
MOLDESTAD, crochets très fins	172	Pincés-gouges	224-228
MORRIS, écarteurs	183	Plaquettes en carbure de tungstène avec profil pyramidal	136,137
MORRIS-DE BAKEY, pincés atraumatiques	280	PLESTER, canules d'aspiration	216
MORSE FAVALORO, écarteurs des côtes	247	POOLE, canules d'aspiration	214
MOSQUITO-HALSTED, pincés hémostatiques	45	POOLE-BABY, canules d'aspiration	214
MOSQUITO-MICRO, pincés hémostatiques	45	Porte-aiguilles à mors en carbure de tungstène	140-155
MÜLLER, clips vasculaires	259	Porte-coton	202,203
MUMMERY-LOCKHART, sondes	202	POTTS, pincés atraumatiques	266
MYRTLE LEAF, sondes	201	POTTS-DE MARTEL, ciseaux vasculaires	102
N		POTTS-SMITH, ciseaux	104
NABATOFF, trousse à varices	203	POTTS-SMITH, ciseaux tungstène TUC	123
NEIVERT, porte-aiguilles tungstène TUC	143	POTTS-SMITH, ciseaux vasculaires	99,101
NELATON, sondes	201	POTTS-SMITH, micro-porte-aiguilles tungstène TUC	153
NELSON-METZENBAUM, ciseaux à dissection	95	POTTS-SMITH, pincés à dissection et à griffes	81
Nerve, micro-ciseaux	113	POTTS-SMITH, pincés à dissection tungstène TUC	85
NEW ORLEANS, porte-aiguilles tungstène TUC	142	PRATT, sonde fistulaire	202
nopa DIAMOND, porte-aiguilles	154,155	PRESBYTERIAN, presses-tube	68
O		Presses-tube	68
O'BRIEN, ciseaux fins	106	PRICE-THOMAS, pincés-clamps à bronches	297
OCHSNER, pincés atraumatiques	281	PROVIDENCE-HOSPITAL, pincés hémostatiques	46
OCHSNER-KOCHER, pincés hémostatiques	49	PYNCHON-ANDREWS, canules d'aspiration	213
OEHLER, pincés à dissection tungstène TUC	85	R	
OLLIER, écarteurs	179	RAGNELL (KILNER), ciseaux à dissection	98
OLSEN-HEGAR, porte-aiguilles tungstène TUC	146	RAGNELL-DAVIS, écarteurs fins	176
Optiques	304,305	RAMPLEY, pincés à éponges	169
O'SHAUGNESSY-MIXTER, pincés à dissection et à ligatures	61	RANKIN-CRILE, pincés hémostatiques	47
OVERHOLT, pincés à disséquer et à ligatures	52	RANKIN-KELLY, pincés hémostatiques	47
OVERHOLT-BABY, pincés à dissection et à ligatures	51	Rapprocheurs des côtes	254
OVERHOLT-GEISSENDOERFER, pincés à dissection et à ligatures	51	REILL, micro-porte-aiguilles à manches rondes	157
OVERHOLT-MIXTER, pincés à dissection et à ligatures	57	REYNOLDS, ciseaux à dissection	98
P		ROBERTS, pincés-clamps à bronches	58
PEAN, pincés hémostatiques	43	ROCHESTER-CARMALT, pincés hémostatiques	55
PEAN-DELICATE, pincés hémostatiques	50	ROCHESTER-PEAN, pincés hémostatiques	48
PEAN-ROCHESTER, pincés hémostatiques	48	ROEDER, pincés à champs	67
PEERS, pincés à champs	67	ROETTGEN-RUSKIN, pincés-gouges	226
PENFIELD, spatules	251	Rugines raspatoires	235,236
Pincés	71-87	RUMEL, pincés à dissection et à ligatures	59
Pincés à champs	66,67	RUMEL-BELMONT, tourniquets	299
Pincés à compresses	66,67	RUSKIN, pincés-gouges	224,228
Pincés à dissection avec mors en carbure de tungstène	85-87	RUSKIN-LISTON, pincés coupantes à os	230
Pincés à disséquer et à ligatures	51-53,57,59-65	RYDER MICRO, porte-aiguilles tungstène TUC	141
Pincés à fil	222,223	RYDER-FRENCH EYE, porte-aiguilles tungstène TUC	141
Pincés à ligatures avec plate-forme	82,83	RYDER-LANGENBECK, porte-aiguilles tungstène TUC	150
Pincés à pansements	163-169	RYDER-MATHIEU VASCULAR, porte-aiguilles tungstène TUC	148
Pincés à poser	41	RYDER-MATHIEU, porte-aiguilles tungstène TUC	148
Pincés à préhension endoscopie	307-312	S	
Pincés à torsader le fil tungstène TUC	151	SANTULLI, clamps atrauma bulldog	260
Pincés atrauma	84	SANVENERO, ciseaux à dissection	98
Pincés atraumatiques	264-296	SAROT, pincés-clamps à bronches	58
Pincés auriculaires	57	SAROT, porte-aiguilles tungstène TUC	145
Pincés coupantes à os	229-232	SATINSKY, ciseaux vasculaires	103
Pincés hémostatiques	35-68	SATINSKY, pincés atraumatiques	272,274
Pincés hémostatiques fines	45	SATINSKY, pincés vena cava	298
Pincés hémostatiques graciles	50	SAUERBRUCH, costotomes	237
		SAUERBRUCH, écarteurs	182,192
		SAUERBRUCH, pincés-gouges	227

	Page		Page
SAWTELL-SCHNIDT, pinces hémostatiques pour amygdales	55	Trocards à manche et trocards	321-325
SCHAEDEL, pinces à champs	66	Trousse à varices	203
SCHMID, spatules vasculaires	251	TROUTMAN, micro-porte-aiguilles à manches rondes	157
SCHMIEDEN-TAYLOR, ciseaux vasculaires	102	TROUTMAN-BARRAQUER, micro-porte-aiguilles à manches rondes	156
SCHNIDT-SAWTELL, pinces hémostatiques pour amygdales	55	TUBBS, dilateurs	299
SELLORS, rapprocheurs des côtes	254	Tubes d'aspiration et canules	211-216
SELLORS-CRAFOORD, pinces auriculaires	57	TÜBINGER MODELL, écarteurs	184
SEMB, pinces coupantes à os	232	TUDOR-EDWARDS, pinces coupantes à os	231
SEMB, pinces-clamps à bronches	297	TUFFIER, écarteurs	185
SEMB, pinces-gouges	225	TUFFIER, écarteurs des côtes	240
SEMB, rugines-raspatoires	236	TUFFIER, pinces hémostatiques	42
SEMKEN, pinces à dissection et à griffes	77,78	U	
SEMKEN, pinces à dissection tungstène TUC	85	UCKERMANN, porte-coton	203
SENN-GREEN, écarteurs fins	173	ULRICH, pinces à pansements	165
SENNING (SWEDISH PATTERN), porte-aiguilles tungstène TUC	142	UNIVERSAL, ciseaux tungstène TUC	128
SENN-MILLER, écarteurs fins	176	V	
SENN-MILLER-BABY, écarteurs fins	176	VERNET-GIL, écarteurs fins	175
SIMON, écarteurs	184	VOLKMANN, écarteurs	177,178
SMITH-PETERSON, pinces-gouges	228	W	
SMITH-POTTS, ciseaux	104	WALTON, ciseaux fins	106
SMITH-POTTS, ciseaux vasculaires	99,101	WALTON-LISTON, pinces coupantes à os	230
SMITH-POTTS, micro-porte-aiguilles tungstène TUC	153	WALTON-YANKAUER, canules d'aspiration	213
SMITH-POTTS, pinces à dissection et à griffes	81	WANGENSTEEN, pinces à dissection tungstène TUC	87
SNITMAN, écarteurs autostatiques	194	WANGENSTEEN, porte-aiguilles tungstène TUC	145
Sondes	201,202	WEBER, pinces atraumatiques	277
Sondes et instruments vaisseaux	199-209	WEBSTER, porte-aiguilles tungstène TUC	143
Sources à lumière froide	332-338	WEITLANER, écarteurs autostatiques	195
Spatules	251	WEITLANER-BABY, écarteurs autostatiques	195
Spatules pulmonaires	255	WELLS-SPENCER, pinces hémostatiques	44
SPENCER-WELLS, pinces hémostatiques	44	WERTHEIM, porte-aiguilles tungstène TUC	146
STACKE, sondes	201	WIKSTROEM, pinces à dissection et à ligatures	65
STANDARD, ciseaux tungstène TUC	118,119	Y	
STANDARD, pinces à dissection	75	YANKAUER, canules d'aspiration	213
STANDARD, pinces à griffes	75	YANKAUER-WALTON, canules d'aspiration	213
STERNUM, pinces à torsader le fil tungstène TUC	151	Z	
STEVENS, ciseaux à ténatomie	109	ZAUFAL-JANSEN, pinces-gouges	224
STEVENS, ciseaux tungstène TUC	127	ZENKER, écarteurs	190
STILLE, pinces-gouges	225	ZENKER, pinces à dissequer et à ligatures	60
STILLE-LISTON, pinces coupantes à os	231	ZWEIFEL, porte-aiguilles tungstène TUC	150
STILLE-LUER, pinces-gouges	226		
STILLE-RUSKIN, pinces-gouges	225		
STRATTE, porte-aiguilles tungstène TUC	145		
STRULLY, ciseaux vasculaires	101		
SUBRAMANIAN, pinces atraumatiques	296		
SUBRAMANIAN-MINIATURE, pinces atraumatiques	296		
SULLIVAN (BROPHY), ciseaux fins	105		
Super Cut ciseaux SC	91		
Suture	135-161		
Système de bras articulé avec fixage rapide central	342,343		
T			
TAYLOR, écarteurs spinaux	176		
TAYLOR, pinces à dissection et à griffes	78,79		
TAYLOR-CUSHING, pinces à dissection tungstène TUC	86		
TAYLOR-SCHMIEDEN, ciseaux vasculaires	102		
TERRIER, pinces hémostatiques	44		
tini instruments (titan-nitride surface coating)	69,70		
Tire-veines	206		
titan instruments	37,73,93,116,139		
TOENNIS, ciseaux vasculaires	102		
TOENNIS, pinces à dissection et à ligatures	64		
TOENNIS, porte-aiguilles tungstène TUC	149		
TOENNIS-ADSON, ciseaux vasculaires	102		
TOENNIS-ADSON-DELICATE, ciseaux tungstène TUC	127		
TOHOKU-JAPAN, pinces à champs	67		
TÖNNIS, spatules vasculaires	251		
Toracoscopie	301-343		
Tourniquets	299		

Indice alfabetico

	Pagina		Pagina
A			
Accessori per power drills	220	BILLROTH, divaricatori	178
Accu power drill	219	BIRKETT, pinze per preparazioni e legature	65
Accumulatore / Caricabatteria per power drills	221	Bisturi	129-134
Adattatore	333	BONNEY, pinze tungsteno TUC	87
ADSON, cannule per aspirazione	216	BOYNTON, portaghi tungsteno TUC	149
ADSON, divaricatori autostatici	196,197	BOZEMANN, portaghi tungsteno TUC	145
ADSON, pinze	76,77	BRIDGE, pinze per preparazioni e legature	62
ADSON, pinze emostatiche	53	BRODIE, sonde	202
ADSON, pinze tungsteno TUC	86	BROM, divaricatori sottili	252
ADSON-ANDERSON, divaricatori autostatici	196	BROPHY (SULLIVAN), forbici fine	105
ADSON-BABY, divaricatori autostatici	198	BROPHY, pinze anatomiche e chirurgiche	81
ADSON-BABY, pinze emostatiche	53	BROWN-ADSON, pinze anatomiche e chirurgiche	77
ADSON-BROWN, pinze anatomiche e chirurgiche	77	BRUNNER, costotomi	238
ADSON-MICRO, pinze anatomiche e chirurgiche	76	BULLDOG, pinze	40,41
ADSON-TOENNIS, forbici	102	BURFORD, divaricatori costali	250
ADSON-TOENNIS-DELICATE, forbici tungsteno TUC	127	BYRD, cannule per aspirazione	214
Adventitia, micro forbici	111,113	C	
AF-accessori	326-331	CAIRNS, pinze emostatiche	50
Air power drill	219	Cannule e tubi d'aspirazione	211-216
ALEXANDER, periostotomi costali	235	Cannule per aspirazione endoscopia	318,319
ALLIS, pinze per afferrare tessuti	38	Cardiovascolare	233-299
ALLIS-ADAIR, pinze per afferrare tessuti	38	CARMALT-ROCHESTER, pinze emostatiche	55
ALLIS-BABY, pinze per afferrare tessuti	38	CARREL, pinze emostatiche	44
ALLISON, spatole per polmone	255	CARROLL, portaghi tungsteno TUC	142
ALM, divaricatori autostatici	194	CARTILAGE-MARTIN, forbici	104
ANDERSON-ADSON, divaricatori autostatici	196	CASTANEDA, divaricatori costali	249
ANDREWS-PYNCHON, cannule per aspirazione	213	CASTANEDA, pinze atrauma	294
ANKENEY, divaricatori costali	242,243	CASTROVIEJO, micro-portaghi	160
Approssimatori costali	254	CASTROVIEJO, micro-portaghi tungsteno TUC	152,153
ARRUGA, portaghi tungsteno TUC	149	Cavi da connessione	326
Astuccio per varici	203	Cavi fibra ottica	332
AUSTIN, pinze per legature	82	Cesoie per ossa	229-232
B			
BABCOCK, pinze per afferrare l'intestino	39	CHAPUT, pinze emostatiche	42
BABY-ADSON, pinze emostatiche	53	CHURCH, forbici	103
BABY-CRILE-WOOD, portaghi tungsteno TUC	144	CLASSON, forbici	103
BABY-MIXTER, pinze per preparazioni e legature	61	CLEVELAND, cesoie per ossa	230
BABY-OVERHOLT, pinze per preparazioni e legature	51	CLEVELAND-GARDNER, cesoie per ossa	229
BABY-POOLE, cannule per aspirazione	214	Clips	257-259
BABY-SATINSKY, pinze cava vena	298	COLLER, pinze emostatiche	47
BABY-SENN-MILLER, divaricatori sottili	176	COLLIN, manici per bisturi	132
BABY-WEITLANER, divaricatori autostatici	195	CONE, divaricatori autostatici	198
BACKHAUS, pinze per fissare le compresse (Fissatele)	67	CONVERSE, portaghi tungsteno TUC	143
BADGLEY, divaricatori costali	240	COOLEY, cannule per aspirazione	215
BAILEY, approssimatori costali	254	COOLEY, dilatatori	299
BAILEY-BABY, approssimatori costali	254	COOLEY, dilatatori per vasi	204
BAILEY-GIBBON, approssimatori costali	254	COOLEY, divaricatori atriali	256
BAINBRIDGE, pinze atrauma	268	COOLEY, divaricatori costali	249
BAINBRIDGE, pinze emostatiche	55	COOLEY, pinze atrauma	285-288,291
BALL & SOCKET, pinze per fissare le compresse (Fissatele)	67	COOLEY-DERRA, pinze atrauma	289
BALLENGER-FOERSTER, pinze per spugne	168	COOLEY-STRUCK, divaricatori atriali	256
BARRAQUER, micro-portaghi con manici rotondi	156	CORWIN, pinze per ritorcere TUC	151
BARRAQUER-TROUTMAN, micro-portaghi con manici rotondi	156	CORYLLOS, costotomi	237
BECK, pinze atrauma	283,289	CORYLLOS, divaricatori	192
BECK-LUETHY, portaghi tungsteno TUC	150	Costotomi	237,238
BENGOLEA, pinze emostatiche	56	COTTLE KAZANJIAN, cesoie per ossa	229
BERNHARD, pinze per fissare le compresse (Fissatele)	66	COUPLAND, cannule per aspirazione	214
BETHUNE, costotomi	237	CRAFOORD, forbici	104
BEYER, pinze-sgorbie	224	CRAFOORD, pinze per bronchi	58
BIEMER, clips vascolari	258	CRAFOORD-SELLORS, pinze auricolari	57
BIEMER, divaricatori sottili	253	CRILE, divaricatori sottili	252
		CRILE, pinze emostatiche	47
		CRILE-RANKIN, pinze emostatiche	47
		CRILE-WOOD, portaghi tungsteno TUC	144

	Pagina		Pagina
CRILE-WOOD-BABY, portaghi tungsteno TUC	144		
CUSHING, divaricatori sottili	172,174,252	F	
CUSHING, divaricatori spinali	176		
CUSHING, pinze anatomiche e chirurgiche	80	FARRELL, portacotone	202
CUSHING, pinze tungsteno TUC	86	FAVALORO, forbici	101
CUSHING-TAYLOR, pinze tungsteno TUC	86	FEIN, portacotone	203
		FERGUSSON, cannule per aspirazione	216
D		FINOCCHIETTO, divaricatori costali	241,248
DALE, pinze atrauma	282	FINOCCHIETTO, forbici	104
DANDY, forbici	101	FINOCCHIETTO, portaghi tungsteno TUC	145
DANDY, pinze per il cuoio capelluto	54	FINOCCHIETTO-BABY, divaricatori costali	241
DARDIK, pinze atrauma	290	FINSEN, divaricatori autostatici	194
DAVIDSON, divaricatori	193	FISCH, divaricatori sottili	253
DAVIS, spatole vascolari	251	FOERSTER-BALLENGER, pinze per spugne	168
DAVIS-RAGNELL, divaricatori sottili	176	Forbici	89-128
DE BAKEY, cannule per aspirazione	213	Forbici con taglio al carburo di tungsteno	118-128
DE BAKEY, dilatatori per vasi	205	Forbici coronaria	101
DE BAKEY, divaricatori costali	245,246	Forbici Face-lift TUC	127
DE BAKEY, forbici per chirurgia vascolare	99,102	Forbici fini	105-109
DE BAKEY, forbici tungsteno TUC	123	Forbici micro	110-116
DE BAKEY, pinze atrauma	84	Forbici per anatomia	104
DE BAKEY, pinze atrauma	267,269-273,275,279,284,295	Forbici per cartilagini	104
DE BAKEY, pinze atrauma bulldog	260	Forbici per chirurgia vascolare	99-103
DE BAKEY, pinze tungsteno TUC	87	Forbici per episiotomia	104
DE BAKEY, portaghi tungsteno TUC	140	Forbici per iridectomia	107
DE BAKEY-BAHNSON, pinze atrauma	275	Forbici per lobectomia	104
DE BAKEY-CAROTIS, pinze atrauma bulldog	262	Forbici per nervi	97
DE BAKEY-HESS, clips vascolari	259	Forbici per preparazioni	95-98
DE BAKEY-MOSQUITO, pinze atrauma	264	Forbici Super-Cut SC	91
DE BAKEY-PEAN, pinze atrauma	265	Forbici Super-Cut SC con taglio al carburo di tungsteno TUC	117
DE BAKEY-RANKIN, pinze atrauma	264	FRANKENFELDT, pinze per afferrare	207
DE BAKEY-SATINSKY, pinze atrauma bulldog	262	FRAZIER, cannule per aspirazione	216
DE MARTEL-POTTS, forbici	102	FRENCH-EYE-RYDER, portaghi tungsteno TUC	141
DEAVER, divaricatori	187-189	FRYKHOLM, pinze-sgorbie	227
DERF, portaghi tungsteno TUC	143	FULTON, forbici	103
DERRA, pinze atrauma	282	G	
DESMARRES, divaricatori sottili	174	GARETT, dilatatori per vasi	204
DIEFFENBACH, pinze bulldog	41	GEISSENDOERFER-OVERHOLT, pinze per preparazioni e legatura	51
DIETRICH, micro-portaghi tungsteno TUC	153	GEMINI, pinze per preparazioni e legatura	63
DIETRICH-HEGEMANN, forbici per chirurgia vascolare	100	GERALD, pinze anatomiche e chirurgiche	80
DIETRICH, pinze atrauma	281	GIERTZ-STILLE, costotomi	238
Dilatatori	299	GILLIES, divaricatori sottili	253
Dilatatori per vasi	204,205	GILLIES, pinze tungsteno TUC	85
Dissection, micro forbici	111,113	GILLIES, portaghi tungsteno TUC	146
Divaricatori	171-198	GIL-VERNET, divaricatori sottili	175
Divaricatori atriali	256	GLOVER, pinze atrauma	283
Divaricatori endoscopia	313	GLOVER, pinze atrauma bulldog	261
Divaricatori sottili	172-176,252,253	GLUCK, costotomi	237
Divaricatori spinali	176	GOLDMAN-FOX, forbici tungsteno TUC	127
DIXON-LOVELACE, pinze emostatiche	54	GORNEY, forbici per preparazioni	97
DOYEN, divaricatori	185	GREEN-SENN, divaricatori sottili	173
DOYEN, periostotomi costali	235	GREGORY, pinze atrauma	281
DOYEN, pinze per fissare le compresse (Fissatele)	66	GREGORY-SOFT, pinze atrauma bulldog	263
DOYEN, sonde	201	GROSS-MAIER, pinze per polipi	166,167
DUNHILL, pinze emostatiche	50	H	
DUVAL, pinze per afferrare l'intestino	39	HAIGHT, divaricatori costali	239
E		HALSEY, portaghi tungsteno TUC	143
easyClean	306-309	HALSTED, pinze emostatiche	46
ECHLIN, pinze-sgorbie	227	HALSTED-MOSQUITO, pinze emostatiche	45
EISELSBERG-MATHIEU, portaghi tungsteno TUC	150	HARKEN, pinze atrauma	276
Elettrodi	327,328	HARKEN, pinze vena cava	298
Elettrodi con tubo d'aspirazione	314-317,320	HARRINGTON, divaricatori	185
Elettrodi/Aspirazione/Irrigazione/Aghi speciali/Trequarti	314-325	HARTMANN, pinze emostatiche	44
ENGL. MODELL, pinze per fissare le compresse (Fissatele)	66	HEGAR, dilatatori	208,209
EUFRATE-PASQUE, portaghi tungsteno TUC	141	HEGAR-OLSEN, portaghi tungsteno TUC	146
EWALD, pinze anatomiche e chirurgiche	77		

	Pagina		Pagina
HEGEMANN-DIETHRICH, forbici per chirurgia vascolare	100	LEKSELL-STILLE, pinze-sgorbie	226
HEISS, pinze emostatiche	58	LELAND-JONES, pinze atrauma	268
HERTZLER, divaricatori costali	240	LERICHE, pinze emostatiche	46
HOPKINS-JOHNS, pinze bulldog	41	LEXER, forbici per preparazioni	97
HOPKINS-JOHNS, pinze per posizionare	41	LEXER, forbici tungsteno TUC	124
HOPKINS-JOHNS, pinze per preparazioni e legatura	60	LICHTENBERG, portaghi tungsteno TUC	149
HORNE-JOBSON, portacotone	203	LINCOLN, forbici	103
HÖSEL, portaghi tungsteno TUC	149	LISTER, forbici tungsteno TUC	128
HOSPITAL-PROVIDENCE, pinze emostatiche	46	LISTON, cesoie per ossa	229,232
I		LISTON-KEY, cesoie per ossa	231
I.M.A. MAMMARIA, divaricatori costali	239	LITTAUER-LISTON, cesoie per ossa	229
ISRAEL, divaricatori	179	LITTLER, forbici fini	105
J		LOCKHART-MUMMERY, sonde	202
JACOBSON, micro-portaghi	160	LORNA, pinze per fissare le compresse (Fissatele)	67
JACOBSON, micro-portaghi tungsteno TUC	152	LOTH-KLINKENBERGH, forbici	103
JACOBSON, portaghi tungsteno TUC	142	LOVELACE, pinze per polmoni	297
JANSEN, divaricatori autostatici	194	LOVELACE-DIXON, pinze emostatiche	54
JAVID, pinze atrauma	285	LUETHY-BECK, portaghi tungsteno TUC	150
JEWELER, pinze tungsteno TUC	85	M	
JOBSON-HORNE, portacotone	203	Macchine fotografiche	339-341
JOHNS-HOPKINS, pinze bulldog	41	Manici per bisturi	131-133
JOHNS-HOPKINS, pinze per posizionare	41	Manicotti trequarti e trequarti	321-325
JOHNS-HOPKINS, pinze per preparazioni e legatura	60	MARKWALDER, cesoie per ossa	229
JONES, pinze per fissare le compresse (Fissatele)	66	MARQUARDT, pinze-sgorbie	224
JOSEPH, forbici per preparazioni	98	MARTIN, divaricatori	184
K		MARTIN-CARTILAGE, forbici	104
KADER, divaricatori	191	MASSON, portaghi tungsteno TUC	145
KALT, micro-portaghi tungsteno TUC	153	MATHIEU, portaghi tungsteno TUC	147
KANTROWITZ, pinze per preparazioni e legature	63	MATHIEU-DELICATE, portaghi tungsteno TUC	147
KAYE, forbici Face-lift	127	MATHIEU-EISELSBERG, portaghi tungsteno TUC	150
KELLY, divaricatori	186	MATHIEU-RYDER VASCULAR, portaghi tungsteno TUC	148
KELLY, pinze emostatiche	47	MATHIEU-RYDER, portaghi tungsteno TUC	148
KELLY-RANKIN, pinze emostatiche	47	MATSON, periostotomi costali	235
KILNER (RAGNELL), forbici per preparazioni	98	MAYFIELD, pinze-sgorbie	224
KILNER, divaricatori sottili	253	MAYO, forbici tungsteno TUC	119
KILNER, portaghi tungsteno TUC	143	MAYO-HEGAR, portaghi tungsteno TUC	140
KLINIKUM BERLIN, pinze serratubi	68	MAYO-HEGAR-DELICATE, portaghi tungsteno TUC	140
KLINKENBERGH-LOTH, forbici	103	MC INDOE, cesoie per ossa	230
KOCHER, divaricatori	177,182	MC INDOE, forbici	104
KOCHER-DELICATE, pinze emostatiche	50	MC INDOE, pinze anatomiche e chirurgiche	77
KOCHER-LANGENBECK, divaricatori	181	MEEKER, pinze per preparazioni e legature	53
KOCHER-OCHSNER, pinze emostatiche	49	MEHDORN, clips vascolari	258
KOERTE, divaricatori	178,189	METZENBAUM, forbici tungsteno TUC	121,122
KRAYENBÜHL, divaricatori sottili	252	METZENBAUM, portaghi tungsteno TUC	147
KROENLEIN, pinze emostatiche	43	METZENBAUM-DELICATE, forbici per preparazioni	96
L		METZENBAUM-DELICATE, forbici tungsteno TUC	124-126
LAMBERT-KAY, pinze atrauma	275	METZENBAUM-NELSON, forbici per preparazioni	95
LAMBOTTE, periostotomi costali	236	MEYERDING, divaricatori sottili	173
Lame per bisturi	133,134	Micro forbici	110-116
LANDOLT, forbici fini	106	Micro forbici Adventitia	111,113
LANE, pinze anatomiche e chirurgiche	79	Micro forbici Dissection	111,113
LANE, pinze per fissare le compresse (Fissatele)	66	Micro forbici Nerve	113
LANGENBECK, divaricatori	180	Micro pinze	82,83
LANGENBECK, portaghi tungsteno TUC	150	MICRO-ADSON, pinze anatomiche e chirurgiche	76
LANGENBECK-DELICATE, portaghi tungsteno TUC	150	MICRO-MOSQUITO, pinze emostatiche	45
LANGENBECK-KOCHER, divaricatori	181	Micro-portaghi	160,161
LANGENBECK-MINI, divaricatori sottili	173	Micro-portaghi con manici rotondi	156-159
LANGENBECK-RYDER, portaghi tungsteno TUC	150	Micro-portaghi con placche di carburo di tungsteno TUC	152,153
LAWRENCE, pinze per preparazioni e legature	62	MICRO-RYDER, portaghi tungsteno TUC	141
LEBSCHKE, costotomi	238	MICROVASCULAR, portaghi tungsteno TUC	141
LEES, pinze atrauma	278	MIKULICZ, divaricatori	186
		MILLS, forbici	102
		MINI, lame per bisturi	133
		MINI, manici per bisturi	133
		MINI-LANGENBECK, divaricatori sottili	173
		MIXTER, pinze per preparazioni e legature	61,62
		MIXTER-BABY, pinze per preparazioni e legature	61

	Pagina		Pagina
MIXTER-O'SHAUGNESSY, pinze per preparazioni e legature	61	Pinze per posizionare	41
MIXTER-OVERHOLT, pinze per preparazioni e legature	57	Pinze per preparazioni e legature	51-53,57,59-65
MOD. BONN, forbici fini	106	Pinze per ritorcere fili TUC	151
MODELL TÜBINGEN, divaricatori	184	Pinze serratubi	68
MOLDESTAD, divaricatori sottili	172	Pinze vena cava	298
MORRIS, divaricatori	183	Pinze-sgorbie	224-228
MORRIS-DE BAKEY, pinze atrauma	280	Placche di carburo di tungsteno con profilo in forma piramidale	136,137
MORSE FAVALORO, divaricatori costali	247	PLESTER, cannule per aspirazione	216
MOSQUITO-HALSTED, pinze emostatiche	45	POOLE, cannule per aspirazione	214
MOSQUITO-MICRO, pinze emostatiche	45	POOLE-BABY, cannule per aspirazione	214
MÜLLER, clips vascolari	259	Portacotone	202,203
MYRTLE-LEAF, sonde	201	Portaghi con placche di carburo di tungsteno	140-155
N		POTTS, pinze atrauma	266
NABATOFF, astuccio per varici	203	POTTS-DE MARTEL, forbici	102
NEIVERT, portaghi tungsteno TUC	143	POTTS-SMITH, forbici	104
NELATON, sonde	201	POTTS-SMITH, forbici per chirurgia vascolare	99,101
NELSON-METZENBAUM, forbici per preparazioni	95	POTTS-SMITH, forbici tungsteno TUC	123
Nerve, micro forbici	113	POTTS-SMITH, micro-portaghi tungsteno TUC	153
NEW ORLEANS, portaghi tungsteno TUC	142	POTTS-SMITH, pinze anatomiche e chirurgiche	81
nopa DIAMOND, portaghi	154,155	POTTS-SMITH, pinze tungsteno TUC	85
O		PRATT, sonda per fistule	202
O'BRIEN, forbici fini	106	PRESBYTERIAN, pinze serratubi	68
OCHSNER, pinze atrauma	281	PRICE-THOMAS, pinze per bronchi	297
OCHSNER-KOCHER, pinze emostatiche	49	PROVIDENCE-HOSPITAL, pinze emostatiche	46
OEHLER, pinze tungsteno TUC	85	PYNCHON-ANDREWS, cannule per aspirazione	213
OLLIER, divaricatori	179	R	
OLSEN-HEGAR, portaghi tungsteno TUC	146	RAGNELL (KILNER), forbici per preparazioni	98
O'SHAUGNESSY-MIXTER, pinze per preparazioni e legature	61	RAGNELL-DAVIS, divaricatori sottili	176
Ottiche	304,305	RAMPLEY, pinze per spugne	169
OVERHOLT, pinze per preparazioni e legature	52	RANKIN-CRILE, pinze emostatiche	47
OVERHOLT-BABY, pinze per preparazioni e legature	51	RANKIN-KELLY, pinze emostatiche	47
OVERHOLT-GEISSENDOERFER, pinze per preparazioni e legature	51	REILL, micro-portaghi con manici rotondi	157
OVERHOLT-MIXTER, pinze per preparazioni e legature	57	REYNOLDS, forbici per preparazioni	98
P		ROBERTS, pinze emostatiche	58
PEAN, pinze emostatiche	43	ROCHESTER-CARMALT, pinze emostatiche	55
PEAN-DELICATE, pinze emostatiche	50	ROCHESTER-PEAN, pinze emostatiche	48
PEAN-ROCHESTER, pinze emostatiche	48	ROEDER, pinze per fissare le compresse (Fissatele)	67
PEERS, pinze per fissare le compresse (Fissatele)	67	ROETTGEN-RUSKIN, pinze-sgorbie	226
PENFIELD, spatole	251	RUMEL, pinze per preparazioni e legature	59
Periostotomi costali	235,236	RUMEL-BELMONT, tornichetti	299
Pinze da presa endoscopia	307-312	RUSKIN, pinze-sgorbie	224,228
Pinze	71-87	RUSKIN-LISTON, cesoie per ossa	230
Pinze atrauma	84	RYDER-FRENCH-EYE, portaghi tungsteno TUC	141
Pinze atrauma	264-296	RYDER-LANGENBECK, portaghi tungsteno TUC	150
Pinze atrauma bulldog	260-263	RYDER-MATHIEU VASCULAR, portaghi tungsteno TUC	148
Pinze auricolari	57	RYDER-MATHIEU, portaghi tungsteno TUC	148
Pinze bulldog	40,41	RYDER-MICRO, portaghi tungsteno TUC	141
Pinze emostatiche	35-68	S	
Pinze emostatiche delicate	50	SANTULLI, pinze atrauma bulldog	260
Pinze emostatiche fine	45	SANVENERO, forbici per preparazioni	98
Pinze emostatiche per tonsille	55	SAROT, pinze per bronchi	58
Pinze micro	82,83	SAROT, portaghi tungsteno TUC	145
Pinze monopolari	329	SATINSKY, forbici	103
Pinze per afferrare l'intestino	39	SATINSKY, pinze atrauma	272,274
Pinze per afferrare tessuti	38	SATINSKY, pinze cava vena	298
Pinze per bronchi	58,297	SAUERBRUCH, costotomi	237
Pinze per dissezione con punte di carburo di tungsteno TUC	85-87	SAUERBRUCH, divaricatori	182,192
Pinze per fissare le compresse (Fissatele)	66,67	SAUERBRUCH, pinze-sgorbie	227
Pinze per la bi-coagulazione	331	SAWTELL-SCHNIDT, pinze emostatiche per tonsille	55
Pinze per ligature con piattaforma	82,83	SCHAEDEL, pinze per fissare le compresse (Fissatele)	66
Pinze per ossa e costole	237,238	SCHMID, spatole vascolari	251
Pinze per polipi	163-169	SCHMIEDEN-TAYLOR, forbici	102
Pinze per polmoni	297	SCHNIDT-SAWTELL, pinze emostatiche per tonsille	55
		SELLORS, approssimatori costali	254
		SELLORS-CRAFOORD, pinze auricolari	57

	Pagina		Pagina
SEMB, cesoie per ossa	232	TROUTMAN-BARRAQUER, micro-portaghi con manici rotondi	156
SEMB, periostotomi costali	236	TUBBS, dilatatori	299
SEMB, pinze per bronchi	297	Tubi d'aspirazione e cannule	211-216
SEMB, pinze-sgorbie	225	TÜBINGEN MODELL, divaricatori	184
SEMKEN, pinze anatomiche e chirurgiche	77,78	TUDOR-EDWARDS, cesoie per ossa	231
SEMKEN, pinze tungsteno TUC	85	TUFFIER, divaricatori	185
SENN-GREEN, divaricatori sottili	173	TUFFIER, divaricatori costali	240
SENNING (SWEDISH PATTERN), portaghi tungsteno TUC	142	TUFFIER, pinze emostatiche	42
SENN-MILLER, divaricatori sottili	176		
SENN-MILLER-BABY, divaricatori sottili	176	U	
SIMON, divaricatori	184	UCKERMANN, portacotone	203
Sistema a braccio articolato con fissaggio rapido centrale	342,343	ULRICH, pinze per polipi	165
SMITH-PETERSON, pinze-sgorbie	228	UNIVERSAL, forbici tungsteno TUC	128
SMITH-POTTS, forbici	104		
SMITH-POTTS, forbici per chirurgia vascolari	99,101	V	
SMITH-POTTS, micro-portaghi tungsteno TUC	153	VERNET-GIL, divaricatori sottili	175
SMITH-POTTS, pinze anatomiche e chirurgiche	81	VOLKMANN, divaricatori	177,178
SMITH-POTTS, pinze tungsteno TUC	85		
SNITMAN, divaricatori autostatici	194	W	
Sonde	201,202	WALTON, forbici fini	106
Sonde e strumenti vascolari	199-209	WALTON-LISTON, cesoie per ossa	230
Sorgente luce fredda	332-338	WALTON-YANKAUER, cannule per aspirazione	213
Spatole	251	WANGENSTEEN, pinze tungsteno TUC	87
Spatole per polmone	255	WANGENSTEEN, portaghi tungsteno TUC	145
Spatole vascolari	251	WEBER, pinze atrauma	277
SPENCER-WELLS, pinze emostatiche	44	WEBSTER, portaghi tungsteno TUC	143
STACKE, sonde	201	WEITLANER, divaricatori autostatici	195
STANDARD, forbici tungsteno TUC	118,119	WEITLANER-BABY, divaricatori autostatici	195
STANDARD, pinze anatomiche per dissezione	75	WELLS-SPENCER, pinze emostatiche	44
STANDARD, pinze chirurgiche a denti di topo	75	WERTHEIM, portaghi tungsteno TUC	146
STERNUM, portaghi tungsteno TUC	151	WIKSTROEM, pinze per preparazioni e legatura	65
STEVENS, forbici per tenotomia	109		
STEVENS, forbici tungsteno TUC	127	Y	
STILLE, pinze-sgorbie	225	YANKAUER, cannule per aspirazione	213
STILLE-LISTON, cesoie per ossa	231	YANKAUER-WALTON, cannule per aspirazione	213
STILLE-LUER, pinze-sgorbie	226		
STILLE-RUSKIN, pinze-sgorbie	225	Z	
STRATTE, portaghi tungsteno TUC	145	ZAUFAL-JANSEN, pinze-sgorbie	224
STRULLY, forbici	101	ZENKER, divaricatori	190
Strumenti per Laparoscopia / Torace	306-313	ZENKER, pinze per preparazioni e legature	60
Strumenti per ossa	217-232	ZWEIFEL, portaghi tungsteno TUC	150
Strumenti vascolari e sonde	199-209		
SUBRAMANIAN, pinze atrauma	296		
SUBRAMANIAN-MINIATURE, pinze atrauma	296		
SULLIVAN (BROPHY), forbici fine	105		
Super Cut forbici SC	91		
Sutura	135-161		
T			
TAYLOR, divaricatori spinali	176		
TAYLOR, pinze anatomiche e chirurgiche	78,79		
TAYLOR-CUSHING, pinze tungsteno TUC	86		
TAYLOR-SCHMIEDEN, forbici	102		
Tenaglie fili	222,223		
TERRIER, pinze emostatiche	44		
tini instruments (titan-nitride surface coating)	69,70		
Tiravene	206		
titan instruments	37,73,93,116,139		
TOENNIS, forbici	102		
TOENNIS, pinze per preparazioni e legature	64		
TOENNIS, portaghi tungsteno TUC	149		
TOENNIS-ADSON, forbici	102		
TOENNIS-ADSON-DELICATE, forbici tungsteno TUC	127		
TOHOKU-JAPAN, pinze per fissare le compresse (Fissatele)	67		
TÖNNIS, spatole vascolari	251		
Toracosopia	301-343		
Tornichetti	299		
TROUTMAN, micro-portaghi con manici rotondi	157		

nopa[®] instruments

nopa instruments

Medizintechnik GmbH
Weilatten 7-9
D-78532 Tuttlingen/Germany

Tel. +49.7462.9490-0
Fax +49.7462.9490-90
info@nopa.de
www.nopa.de

Herstellung und Verkauf chirurgischer
und endoskopischer Instrumente.
Manufacture and Sales of Surgical
and Endoscopic Instruments.

